



Federal Bureau of Investigation
Washington, D.C. 20535

August 25, 2023

MR. JOHN R. GREENEWALD JR.
SUITE 1203
27305 WEST LIVE OAK ROAD
CASTAIC, CA 91384

Request No.: 1362435-000
Subject: CASTRO, FIDEL ALEJANDRO

Dear Mr. Greenewald:

This is in response to your Freedom of Information Act (FOIA) request. Please see the paragraphs below for relevant information specific to your request as well as the enclosed FBI FOIPA Addendum for standard responses applicable to all requests.

The FBI has completed its review of records subject to the FOIA that are responsive to your request. We made these records available in the FBI's electronic FOIA Library (The Vault) on the FBI's public website, <http://vault.fbi.gov>. On the right-hand side of the home page, under the heading "Vault Links" you can search for your subject alphabetically (click on "A-Z Index"), by category (click on "Categories"), or by entering text into our search engine (click on "Search Vault"). For records responsive to this request, please enter "Fidel Castro Part 6", "Fidel Castro Part 7", and "Fidel Castro Part 8" as the search term.

The available documents represent a final Vault posting of information responsive to your FOIA request.

Please see the selected paragraphs below for relevant information specific to your request.

- Additional records potentially responsive to your subject may exist. Please inform us by emailing foipaquestions@fbi.gov or replying through standard mail if you would like the FBI to conduct a search of the indices to our Central Records System.
- Additional records responsive to your request were processed but are not currently available on The Vault. Please inform us by emailing foipaquestions@fbi.gov or replying through standard mail if you would like to receive these records.

Please refer to the enclosed FBI FOIPA Addendum for additional standard responses applicable to your request. "**Part 1**" of the Addendum includes standard responses that apply to all requests. "**Part 2**" includes additional standard responses that apply to all requests for records about yourself or any third party individuals. "**Part 3**" includes general information about FBI records that you may find useful. Also enclosed is our Explanation of Exemptions.

Additional information about the FOIPA can be found at www.fbi.gov/foia. Should you have questions regarding your request, please feel free to contact foipaquestions@fbi.gov. Please reference the FOIPA Request number listed above in all correspondence concerning your request.

Please be advised that if you are seeking a new search for records, you may wish to narrow the scope of your request based on material that you have already received, e.g., timeframe or locality. Additionally, be advised that "unusual circumstances" may apply. See 5 U.S.C. § 552 (a)(6)(B)(iii). These "unusual circumstances" will delay our ability to make a determination on your request within 20 days. See 5 U.S.C. § 552 (a)(6)(B). Additionally, the payment of pertinent fees may apply to your request. See 5 U.S.C. § 552 (a)(4)(A)(viii). The application of "unusual circumstances" is not a determination of how the FBI will respond to your substantive request.

If you are not satisfied with the Federal Bureau of Investigation's determination in response to this request, you may administratively appeal by writing to the Director, Office of Information Policy (OIP), United States Department of Justice, 441 G Street, NW, 6th Floor, Washington, D.C. 20530, or you may submit an appeal through OIP's FOIA STAR portal by creating an account following the instructions on OIP's website: <https://www.justice.gov/oip/submit-and-track-request-or-appeal>. Your appeal must be postmarked or electronically transmitted within ninety (90) days of the date of my response to your request. If you submit your appeal by mail, both the letter and the envelope should be clearly marked "Freedom of Information Act Appeal." Please cite the FOIPA Request Number assigned to your request so it may be easily identified.

You may seek dispute resolution services by emailing the FBI's FOIA Public Liaison at foipaquestions@fbi.gov. The subject heading should clearly state "Dispute Resolution Services." Please also cite the FOIPA Request Number assigned to your request so it may be easily identified. You may also contact the Office of Government Information Services (OGIS). The contact information for OGIS is as follows: Office of Government Information Services, National Archives and Records Administration, 8601 Adelphi Road-OGIS, College Park, Maryland 20740-6001, e-mail at ogis@nara.gov; telephone at 202-741-5770; toll free at 1-877-684-6448; or facsimile at 202-741-5769.

Sincerely,



Michael G. Seidel
Section Chief
Record/Information Dissemination Section
Information Management Division

Enclosures

FBI FOIPA Addendum

As referenced in our letter responding to your Freedom of Information/Privacy Acts (FOIPA) request, the FBI FOIPA Addendum provides information applicable to your request. Part 1 of the Addendum includes standard responses that apply to all requests. Part 2 includes standard responses that apply to requests for records about individuals to the extent your request seeks the listed information. Part 3 includes general information about FBI records, searches, and programs.

Part 1: The standard responses below apply to all requests:

- (i) **5 U.S.C. § 552(c).** Congress excluded three categories of law enforcement and national security records from the requirements of the FOIPA [5 U.S.C. § 552(c)]. FBI responses are limited to those records subject to the requirements of the FOIPA. Additional information about the FBI and the FOIPA can be found on the www.fbi.gov/foia website.
- (ii) **Intelligence Records.** To the extent your request seeks records of intelligence sources, methods, or activities, the FBI can neither confirm nor deny the existence of records pursuant to FOIA exemptions (b)(1), (b)(3), and as applicable to requests for records about individuals, PA exemption (j)(2) [5 U.S.C. §§ 552/552a (b)(1), (b)(3), and (j)(2)]. The mere acknowledgment of the existence or nonexistence of such records is itself a classified fact protected by FOIA exemption (b)(1) and/or would reveal intelligence sources, methods, or activities protected by exemption (b)(3) [50 USC § 3024(i)(1)]. This is a standard response and should not be read to indicate that any such records do or do not exist.

Part 2: The standard responses below apply to all requests for records on individuals:

- (i) **Requests for Records about any Individual—Watch Lists.** The FBI can neither confirm nor deny the existence of any individual's name on a watch list pursuant to FOIA exemption (b)(7)(E) and PA exemption (j)(2) [5 U.S.C. §§ 552/552a (b)(7)(E), (j)(2)]. This is a standard response and should not be read to indicate that watch list records do or do not exist.
- (ii) **Requests for Records about any Individual—Witness Security Program Records.** The FBI can neither confirm nor deny the existence of records which could identify any participant in the Witness Security Program pursuant to FOIA exemption (b)(3) and PA exemption (j)(2) [5 U.S.C. §§ 552/552a (b)(3), 18 U.S.C. 3521, and (j)(2)]. This is a standard response and should not be read to indicate that such records do or do not exist.
- (iii) **Requests for Confidential Informant Records.** The FBI can neither confirm nor deny the existence of confidential informant records pursuant to FOIA exemptions (b)(7)(D), (b)(7)(E), and (b)(7)(F) [5 U.S.C. § 552 (b)(7)(D), (b)(7)(E), and (b)(7)(F)] and Privacy Act exemption (j)(2) [5 U.S.C. § 552a (j)(2)]. The mere acknowledgment of the existence or nonexistence of such records would reveal confidential informant identities and information, expose law enforcement techniques, and endanger the life or physical safety of individuals. This is a standard response and should not be read to indicate that such records do or do not exist.

Part 3: General Information:

- (i) **Record Searches and Standard Search Policy.** The Record/Information Dissemination Section (RIDS) searches for reasonably described records by searching systems, such as the Central Records System (CRS), or locations where responsive records would reasonably be found. The CRS is an extensive system of records consisting of applicant, investigative, intelligence, personnel, administrative, and general files compiled by the FBI per its law enforcement, intelligence, and administrative functions. The CRS spans the entire FBI organization, comprising records of FBI Headquarters, FBI Field Offices, and FBI Legal Attaché Offices (Legats) worldwide; Electronic Surveillance (ELSUR) records are included in the CRS. The standard search policy is a search for main entity records in the CRS. Unless specifically requested, a standard search does not include a search for reference entity records, administrative records of previous FOIPA requests, or civil litigation files.
 - a. *Main Entity Records* – created for individuals or non-individuals who are the subjects or the focus of an investigation
 - b. *Reference Entity Records*- created for individuals or non-individuals who are associated with a case but are not known subjects or the focus of an investigation
- (ii) **FBI Records.** Founded in 1908, the FBI carries out a dual law enforcement and national security mission. As part of this dual mission, the FBI creates and maintains records on various subjects; however, the FBI does not maintain records on every person, subject, or entity.
- (iii) **Foreseeable Harm Standard.** As amended in 2016, the Freedom of Information Act provides that a federal agency may withhold responsive records only if: (1) the agency reasonably foresees that disclosure would harm an interest protected by one of the nine exemptions that FOIA enumerates, or (2) disclosure is prohibited by law (5 United States Code, Section 552(a)(8)(A)(i)). The FBI considers this foreseeable harm standard in the processing of its requests.
- (iv) **Requests for Criminal History Records or Rap Sheets.** The Criminal Justice Information Services (CJIS) Division provides Identity History Summary Checks – often referred to as a criminal history record or rap sheet. These criminal history records are not the same as material in an investigative "FBI file." An Identity History Summary Check is a listing of information taken from fingerprint cards and documents submitted to the FBI in connection with arrests, federal employment, naturalization, or military service. For a fee, individuals can request a copy of their Identity History Summary Check. Forms and directions can be accessed at www.fbi.gov/about-us/cjis/identity-history-summary-checks. Additionally, requests can be submitted electronically at www.edo.cjis.gov. For additional information, please contact CJIS directly at (304) 625-5590.

EXPLANATION OF EXEMPTIONS

SUBSECTIONS OF TITLE 5, UNITED STATES CODE, SECTION 552

- (b)(1) (A) specifically authorized under criteria established by an Executive order to be kept secret in the interest of national defense or foreign policy and (B) are in fact properly classified to such Executive order;
- (b)(2) related solely to the internal personnel rules and practices of an agency;
- (b)(3) specifically exempted from disclosure by statute (other than section 552b of this title), provided that such statute (A) requires that the matters be withheld from the public in such a manner as to leave no discretion on issue, or (B) establishes particular criteria for withholding or refers to particular types of matters to be withheld;
- (b)(4) trade secrets and commercial or financial information obtained from a person and privileged or confidential;
- (b)(5) inter-agency or intra-agency memorandums or letters which would not be available by law to a party other than an agency in litigation with the agency;
- (b)(6) personnel and medical files and similar files the disclosure of which would constitute a clearly unwarranted invasion of personal privacy;
- (b)(7) records or information compiled for law enforcement purposes, but only to the extent that the production of such law enforcement records or information (A) could reasonably be expected to interfere with enforcement proceedings, (B) would deprive a person of a right to a fair trial or an impartial adjudication, (C) could reasonably be expected to constitute an unwarranted invasion of personal privacy, (D) could reasonably be expected to disclose the identity of confidential source, including a State, local, or foreign agency or authority or any private institution which furnished information on a confidential basis, and, in the case of record or information compiled by a criminal law enforcement authority in the course of a criminal investigation, or by an agency conducting a lawful national security intelligence investigation, information furnished by a confidential source, (E) would disclose techniques and procedures for law enforcement investigations or prosecutions, or would disclose guidelines for law enforcement investigations or prosecutions if such disclosure could reasonably be expected to risk circumvention of the law, or (F) could reasonably be expected to endanger the life or physical safety of any individual;
- (b)(8) contained in or related to examination, operating, or condition reports prepared by, on behalf of, or for the use of an agency responsible for the regulation or supervision of financial institutions; or
- (b)(9) geological and geophysical information and data, including maps, concerning wells.

SUBSECTIONS OF TITLE 5, UNITED STATES CODE, SECTION 552a

- (d)(5) information compiled in reasonable anticipation of a civil action proceeding;
- (j)(2) material reporting investigative efforts pertaining to the enforcement of criminal law including efforts to prevent, control, or reduce crime or apprehend criminals;
- (k)(1) information which is currently and properly classified pursuant to an Executive order in the interest of the national defense or foreign policy, for example, information involving intelligence sources or methods;
- (k)(2) investigatory material compiled for law enforcement purposes, other than criminal, which did not result in loss of a right, benefit or privilege under Federal programs, or which would identify a source who furnished information pursuant to a promise that his/her identity would be held in confidence;
- (k)(3) material maintained in connection with providing protective services to the President of the United States or any other individual pursuant to the authority of Title 18, United States Code, Section 3056;
- (k)(4) required by statute to be maintained and used solely as statistical records;
- (k)(5) investigatory material compiled solely for the purpose of determining suitability, eligibility, or qualifications for Federal civilian employment or for access to classified information, the disclosure of which would reveal the identity of the person who furnished information pursuant to a promise that his/her identity would be held in confidence;
- (k)(6) testing or examination material used to determine individual qualifications for appointment or promotion in Federal Government service the release of which would compromise the testing or examination process;
- (k)(7) material used to determine potential for promotion in the armed services, the disclosure of which would reveal the identity of the person who furnished the material pursuant to a promise that his/her identity would be held in confidence.

This document is made available through the declassification efforts
and research of John Greenewald, Jr., creator of:

The Black Vault



The Black Vault is the largest online Freedom of Information Act (FOIA) document clearinghouse in the world. The research efforts here are responsible for the declassification of hundreds of thousands of pages released by the U.S. Government & Military.

Discover the Truth at: <http://www.theblackvault.com>

FEDERAL BUREAU OF INVESTIGATION
FREEDOM OF INFORMATION/PRIVACY ACTS SECTION

SUBJECT: FIDEL CASTRO

FILE NUMBER: 139-1201

FEDERAL BUREAU OF INVESTIGATION

<small>Office</small> SALT LAKE CITY	<small>Office of Origin</small> SALT LAKE CITY	<small>Date</small> 11/10/60	<small>Investigative Period</small> 11/1/60
<small>TITLE OF CASE</small> ARTHUR JAMES BALLETTI		<small>Report made by</small> [REDACTED] b7C	<small>Typed by</small> JI
		<small>CHARACTER OF CASE</small> UNAUTHORIZED PUBLICATION AND USE OF COMMUNICATIONS	

XXXXXX REFERENCE: Salt Lake City airtel to the Bureau, dated 11/4/60

- C -

ADMINISTRATIVE

b7C The information contained in this report was received from [REDACTED] Clark County Sheriff's Office, Las Vegas, Nevada. Mr. DAN ROWAN made no formal complaint with regard to his telephone being tapped at the Riviera Hotel.

It will be noted that [REDACTED] advised that the conversations recorded were those of DAN ROWAN of the Rowan and Martin comedy team, presently appearing at the Riviera Hotel in Las Vegas, and PHYLLIS MC GUIRE of the McGuire Sisters Trio. ROWAN advised [REDACTED] in strictest confidence.

<small>Approved</small> <small>Copies made:</small>	<small>Special Agent In Charge</small> 2 - Bureau 1 - Miami (Info) 3 - Salt Lake City (139-17)	<small>Do not write in spaces below</small> 139-1192 N 139-1201-1 12 NOV 14 1960 STAT. SECT.
--	---	--

Property of FBI - This report is loaned to you by the FBI and neither it nor its contents are to be distributed outside the agency to which loaned.

DEC 1 1960

SU 139-17

b7C
b7D
[REDACTED]
on 11/1/60, ROWAN signed a statement at the Clark County Sheriff's Office, Las Vegas, stating that he wished to have all charges dropped which he had previously requested be filed against BALLETTI at the time it was determined that he had tapped his telephone at the Riviera Hotel.

LEADS

MIAMI DIVISION (INFORMATION)

One copy of report furnished Miami in view of possible future investigation in that division.

UNITED STATES DEPARTMENT OF JUSTICE
FEDERAL BUREAU OF INVESTIGATION

Copy to:

b7c

Report of: [REDACTED]
Date:

11/10/60

Office: Salt Lake City, Utah

Field Office File No.: Salt Lake City 139-17

Bureau File No.:

Title: ARTHUR JAMES BALLETTI

Character: UNAUTHORIZED PUBLICATION AND USE
OF COMMUNICATIONS

Synopsis: BALLETTI arrested 10/31/60 at Riviera Hotel, Las Vegas, Nevada. Admitted that he had received instructions from Investigations, Incorporated, Miami, Florida, to surveil and record telephone conversations of DAN ROWAN. BALLETTI had in his possession numerous electronic devices including transmitters, receivers, Minifon wire recorders, Minox camera, and seventeen professional type lock picks. Also an AM-FM transistor radio which was thought to be receiving on the same frequency that the telephone tap was broadcasting on. BALLETTI stated that FRED T. HARRIS, a free lance electronics man and investigator from Miami, had entered ROWAN's room and had installed the listening device. ROWAN requested that all local charges against BALLETTI be dropped.

- C -

DETAILS:

Date 11/10/60

[REDACTED]
 [REDACTED] Clark County Sheriff's Office, advised he had received a call from the Riviera Hotel, the hotel management advising that two persons had registered in on October 26, 1960, one of them giving the name of ARTHUR BALLETTI and the other as J. W. HARRISON, and that they had given a Water Street address in San Francisco and a Freeman Street address in Los Angeles at the time they registered. The management of the Riviera Hotel had advised that inasmuch as the hotel bill had not been paid that a check of their room, No. 331, had revealed that there were a number of suspicious looking electronic devices and that a number of notes had been made on a yellow pad which contained the name of DAN ROWAN, one of the partners in the Rowan and Martin comedy team, who at that time were appearing at the Riviera Hotel. Also on this pad were several dates, times and places concerning ROWAN's whereabouts for the past several days. The hotel management advised they had determined the person who had registered as J. W. HARRISON was FRED T. HARRIS and that he had left the hotel on October 30, 1960.

[REDACTED] stated on his arrival at the Riviera Hotel that he observed BALLETTI paying his hotel bill at the front desk and he had several bandages on his hands and arms and appeared to be extremely nervous. He stated that a records' check of his department failed to reveal anything concerning BALLETTI; however, they have a record of J. W. HARRISON, an ex-convict having been previously arrested for forgery, burglary, and robbery.

[REDACTED] stated BALLETTI was contacted in his room and questioned concerning the cuts on his arms which he was unable to properly explain and he stated that the person who had registered with him under the name of J. W. HARRISON was FRED T. HARRIS; that he was from Florida rather than from San Francisco and stated the reason they did not give their true addresses was that they did not want their wives to find out where they were. BALLETTI stated he was in Las Vegas on vacation and that he was employed in Miami as a consultant. He was asked for identification at which time he handed the officers a driver's license in the name of BYRAM whose description was completely different than that of BALLETTI.

On 11/1/60 at Las Vegas, Nevada File # Salt Lake City 139-17
 by SA [REDACTED] j1 b7c Date dictated 11/4/60

SU 139-17

BALLETTI stated that he had given the officers the wrong license; that he had picked this one up from a friend of his and had forgotten to return it. BALLETTI was requested to let the officers search his room at which time he refused. He became very excited and extremely nervous.

An effort at that time was made to locate DAN ROWAN to determine if a microphone or a tap had been made in ROWAN's room. The officers were unsuccessful in locating ROWAN and with the aid of the hotel management his room was entered and [REDACTED] observed a set of bare wires running from the telephone box in ROWAN's room, No. 228, to an electronic transmitting wireless microphone which had been taped to the bed and connected to the telephone box with the bare wires. There was an aerial strung along the back of the bed. This transmitting paraphernalia was removed from the telephone by deputy sheriffs.

BALLETTI was again interrogated by deputy sheriffs and at first denied owning this instrument which had been recovered from ROWAN's room and later would not affirm or deny his knowledge concerning it. He was at that time placed under arrest and a complete search was made of his room. A yellow steno pad revealed notes and notations which BALLETTI had written down dates and times on which he had recorded portions of DAN ROWAN's telephone conversations. A locked suitcase in BALLETTI's room was unlocked with a key which was furnished by BALLETTI and it was determined that this suitcase contained a large quantity of electronic devices including transmitters, receivers, wall plugs, a Minifon wire recorder, a Minox camera and also a set of seventeen professional type lock picks. Also found on the floor near the west wall of the room was a Sony AM-FM transistor radio with a piece of masking tape across the top next to the dial needle with the markings T and R on this tape.

[REDACTED] stated later tests showed that the R on the tape in the shortwave portion of the tuner was the frequency on which one of the transmitters in the suitcase would broadcast on and is believed to be on the same frequency that the telephone microphone was broadcasting on.

[REDACTED] stated on arriving at the Detective

Bureau of the Clark County Sheriff's Office, BALLETTI admitted he had been hired by Investigations, Incorporated, Miami, Florida, which is a company owned by a former FBI Agent, EDWARD DU BOIS, and that this company apparently had a client who had requested investigation concerning DAN ROWAN's private life. BALLETTI admitted listening and recording ROWAN's telephone conversations and he stated he had been surveilling him and listening to his conversations since October 26, 1960.

BALLETTI stated FRED T. HARRIS, who is a free lance electronics man and investigator from Miami, had entered ROWAN's room and had installed the listening device. He stated he had also listed some of the information from notes in ROWAN's room. BALLETTI stated HARRIS had planned on staying long enough just to install the microphone; however, had stayed over a few days in Las Vegas to play the horses and that HARRIS had returned to Florida on the morning of October 30, 1960, by TransWorld Airlines.

[REDACTED] stated ROWAN had related to him in strictest confidence [REDACTED]

[REDACTED]

b7C
b7D

b7C [REDACTED] stated ROWAN appeared at the Clark County Sheriff's Office on November 1, 1960, and signed a release

SU 139-17

stating he desired that all charges against BALLETTI be dropped and that no action be taken by the Clark County Sheriff's Office with regard to the burglary and the intrusion of privacy by use of a listening device stating that BALLETTI was only working for someone else.

In connection with the information in the
attached, SAM GIANCANA, presently under
investigation as a top hoodlum of the Chicago
Office, and it has previously been reported
that he is romantically interested in
Phyllis McGuire of the McGuire Sisters Trio.
Salt Lake City submitting report for referral
to Department.

PS

FBI

Date: 11/4/60

Transmit the following in

PLAIN TEXT

(Type in plain text or code)

Via

AIRTEL

AIR MAIL

(Priority or Method of Mailing)

Mr. Tolson
Mr. DeLoach
Mr. Mohr
Mr. Bishop
Mr. Casper
Mr. Callahan
Mr. Conrad
Mr. Felt
Mr. Gale
Mr. Rosen
Mr. Sullivan
Mr. Tavel
Mr. Trotter
Mr. Tele. Room
Mr. Holmes
Miss Gandy

TO: DIRECTOR, FBI
FROM: SAC, SALT LAKE CITY (139-0)
RE: ARTHUR JAMES BALLETTI
UPUC
(OO: SALT LAKE CITY)

Office of Origin

[redacted] Clark County Sheriff's Office, Las Vegas, Nevada, advised on 11/1/60, he and deputies of his detective staff arrested subject, 29 years of age, on 10/31/60, who stated he is an employee of Investigators, Incorporated, of Miami, Florida, which is reportedly owned by former FBI Special Agent EDWARD DU BOIS. BALLETTI had been monitoring telephone calls and surveilling DAN ROWAN of the comedy team of Rowan and Martin, presently appearing at the Riviera Hotel, Las Vegas.

[redacted] stated a tap was located on the phone in ROWAN'S room and also microphone concealed behind head of bed. [redacted] stated he had confiscated from the room of BALLETTI one spool of recordings and amplifier equipment.

BALLETTI stated he did not know who had requested the surveillance of ROWAN or the monitoring and recording of his telephone conversations as the installation had been made by FNU HARRIS, an employee of Investigators, Incorporated, who had returned to Miami.

[redacted] stated DAN ROWAN had advised that he had called PHYLLIS MC GUIRE, of the Mc Guire Sisters Trio, most every day at Lake Tahoe where the Mc Guire Sisters are appearing at Harrah's Club, and after listening to some of

- P.
- 3 - Bureau (AM)
- 2 - Salt Lake City

LEK:jl

REC-16

EX-136

139-1201-2
~~139-1192-3~~

7 NOV 7 1960

Approved: [Signature]

Special Agent in Charge

Sent

M

Per [Signature]

DEC 1 1960

SU 139-0

recording advised these conversations were between himself and PHYLLIS MC GUIRE and that he intended to arrange to marry PHYLLIS MC GUIRE in July, 1961. ROWAN advised [REDACTED] that he has no idea who might want to surveil him or listen to his telephone calls.

[REDACTED] advised that ROWAN had advised him in strictest confidence [REDACTED]

b7C
b7D
[REDACTED] asked ROWAN if SAM GIANCANA (Anti-Racketeering, OO CHICAGO), who has kept company with PHYLLIS, might be interested in their conversations, to which ROWAN excitedly stated "Did you know about him?"

ROWAN, according to [REDACTED] did not definitely say that this was a possible source but indicated that it could be.

BALLETTI released on \$2000.00 bond after having been charged in State Court with illegal trespass and operating as a private detective without a state license.

ROWAN advised [REDACTED] that he did not desire to prosecute BALLETTI as he is only working for someone else.

Closing report will be submitted 11/10/60.

BLAYLOCK

* OFFICE OF ORIGIN

Office Memorandum • UNITED STATES GOVERNMENT

TO : Director, Federal Bureau of Investigation

DATE: DECEMBER 5 1960

FROM : ^{HRW} Malcolm Richard Wilkey, Assistant Attorney General
Criminal Division

HRW:JWB: [initials]
82-46-115

SUBJECT: Arthur James Balletti
Unauthorized Publication or Use of Communications

Mr. Tolson	_____
Mr. Mohr	_____
Mr. DeLoach	_____
Mr. Casper	_____
Mr. Callahan	_____
Mr. Conrad	_____
Mr. Felt	_____
Mr. Gale	_____
Mr. Rosen	_____
Mr. Sullivan	_____
Mr. Tavel	_____
Mr. Trotter	_____
Tele. Room	_____
Miss Holmes	_____
Miss Gandy	_____

b7C Reference is made to your memorandum of November 22, 1960, with which you forwarded to us a copy of the report of Special Agent [redacted] dated November 10, 1960, at Salt Lake City.

The facts set forth in the report indicate violation of the provisions of 47 U.S.C. 605 and conspiracy by Arthur James Balletti, Fred T. Harris, and possibly Investigations, Inc., and Edward DuBois and others.

It is requested that a full investigation be conducted with a view toward criminal prosecution. Please furnish to the United States Attorney for the District of Nevada a copy of the above-indicated report and copies of all further reports of investigation.

For your information we are this date requesting the United States Attorney to furnish us with his prosecutive opinion upon completion of the investigation, and if time permits, to obtain our prior authorization to institute criminal prosecution.

Handwritten notes on left margin:
[scribbles]

DEC 6 1960
DEC 6 1960
DEC 6 1960

Handwritten: 11/17

REC-44 139-1201-3
DEC 6 1960

FX-109

Handwritten: [scribbles]

Handwritten: copy - Mrs. Rosen

Per's Files

12/8/60

REC-44 AIRTEL
MCT-8 131-1201-3

To: SACs, Salt Lake City (Enc. 2)
Miami (Enc. 2)
Chicago (Enc. 2)

From: Director, FBI

ARTHUR JAMES BALLETTI
UPUC

ReSÜrep 11/10/60, copy to Miami.

Enclosed are two copies of a letter from the Department dated 12/5/60.

You should conduct the full investigation requested by the Department and handle pursuant to the Manual of Instructions, Section 113. Furnish copies of rerep and future reports to appropriate U. S. Attorney.

This matter must be given close supervision by the office of origin (Salt Lake City) and the investigation must be thorough, complete and vigorously pursued throughout. Leads must be expeditiously set out to insure meeting of Ruded.

Dated 12/23/60.

NOTE:

Balletti arrested by Las Vegas, Nevada, SA, 10/31/60, on local wire tapping charge. Admitted he was under instructions from investigations, Inc., Miami, Fla., reportedly owned by former SA Edward Dubois to surveil and record telephone conversations of Ian Rowan of comedy team of Rowan and Martin. Rowan reportedly romantically interested in Phyllis McGuire of McGuire Sisters trio. Rowan was asked by local officers if he thought Sam Giancana might be interested in Rowan's conversations with Phyllis McGuire. Rowan replied "Did you know about him?" Rowan requested local charges against Balletti be dropped. Sam Giancana is under investigation as a top hood.

DEC 11 1960

- Tolson _____
- Nichols _____
- Parsons _____
- Belmont _____
- Callahan _____
- DeLoach _____
- Holmes _____
- McGuire _____
- Rosen _____
- Tamm _____
- Trotter _____
- W.C. Sullivan _____
- Tele. Room _____
- Ingram _____
- Gandy _____

MAIL ROOM TELETYPE UNIT

(See note continued page

7 DEC 21 1960

Note continued:

of the CG Office and has also reportedly been romantically interested in Phyllis McGuire, and may have instigated surveillance and tap. Top hoodlum desk has no objection to investigation which may tie in Giancana. Department requests full investigation in this case.

Balletti arrested by Las Vegas, Nevada, Sheriff's Office, 10/1/60, on local wire tapping charge. Admitted he was under instructions from Investigations, Inc., Miami, Fla., reportedly owned by former SA Edward DuBois to surveil and record telephone conversations of Dan Rowan of comedy team of Rowan and Martin. Rowan reportedly romantically interested in Phyllis McGuire of McGuire Sisters trio. Rowan was asked by local officers if he thought Sam Giancana might be interested in Rowan's conversations with Phyllis McGuire. Rowan replied "Did you know about him?" Rowan requested local charges against Balletti be dropped. Sam Giancana is under investigation as a top hoodlum of the Chicago Office and has also reportedly been romantically interested in Phyllis McGuire. Department requests full investigation in this case which is being ordered.

FBI

Date: 12/14/60

Transmit the following in _____
(Type in plain text or code)

Via AIRTEL AIRMAIL
(Priority or Method of Mailing)

TO: DIRECTOR, FBI
FROM: SAC, MIAMI (139-63)
ARTHUR JAMES BALLETTI
UPUC

cc
21

Enclosed for information of Washington Field Office is autostat of report of SA [redacted] at Salt Lake City dated 11/10/60.

b7c

By letter dated 12/5/60, the Department advised that the facts in this report indicate a violation of 47 U. S. Code, 605 and conspiracy by ARTHUR JAMES BALLETTI, FRED T. HARRIS and possibly Investigations, Inc., EDWARD DU BOIS and others. The Department requested full investigation with a view toward criminal prosecution and copies of all reports should be furnished the U. S. Attorney, District of Nevada.

Former Special Agent EDWARD DU BOIS, who is head of Investigations, Inc., Miami, on interview, says he received phone call 10/25/60 from WALTER FITZPATRICK, representing ROBERT MAHEU, a private investigator at 1125 19th St. N.W., Washington, D. C. FITZPATRICK wanted DU BOIS to send two men to Las Vegas for surveillance work, purpose not explained. DU BOIS purchased tickets in the name of DICK HUNTER and FRED T. HARRIS, both of whom are former Special Agents and employees of DU BOIS. DU BOIS received subsequent call

- P
- (3) - Bureau (AM)
- 2 - Salt Lake City (139-17) (AM)
- 2 - Washington Field (Encl-1) (AM)
- 2 - Miami
- RKL:sll
- (9)

EX-120

139-1201-4

REC-38

57 DEC 21 1960

Approved: ROH
Special Agent in Charge

Sent _____ Per _____

W. C. ...
...

MM 139-63

either from FITZPATRICK or from ROBERT MAHEU in Los Angeles, advising DU BOIS to send only one man to Las Vegas. Caller instructed that a second man had been hired and would be at Eastern Airlines information window, Miami International Airport. DU BOIS then sent BALLETTI to Las Vegas and he was accompanied by the man hired by MAHEU, who identified himself as J. W. HARRISON.

BALLETTI, on interview at Miami, denies monitoring any phone conversations and can furnish no background information regarding HARRISON. Says HARRISON was traveling on ticket of FRED T. HARRIS and for this reason, Las Vegas Sheriff's Office erroneously assumed HARRISON was HARRIS.

BALLETTI described J. W. HARRISON as white, male, age 50, 5'10", 200 pounds, brown hair, balding.

Washington Field Office contact WALTER FITZPATRICK or ROBERT MAHEU as to identity of J. W. HARRISON. Interview HARRISON or set out appropriate lead for his interview.

Miami will forward photograph of FRED HARRIS to Salt Lake City for display at Las Vegas.

Balletti arrested by Las Vegas, Nevada, Sheriff's Office, 10/31/60, on local wire tapping charge. Admitted he was under instructions from Investigation, Inc., Miami, Florida, reportedly owned by former SA Edward Du Bois, and wire tap installation made by (First name unknown) Harris, Du Bois employee, to record telephone conversations of Dan Rowan of comedy team Rowan and Martin. Rowan reportedly romantically interested in Phyllis McGuire of McGuire Sisters trio. Sam Giancana, under investigation as Chicago top hoodlum, also interested in Phyllis McGuire. Department requested full investigation in this case. Bufiles reflect Robert Maheu, ~~JAMES~~ Richard Hunter and Fred T. Harris former SAs.

✓

FEDERAL BUREAU OF INVESTIGATION

Reporting Office LOS ANGELES	Office of Origin SALT LAKE CITY	Date 12/22/60	Investigative Period 12/19 - 21/60
TITLE OF CASE ARTHUR JAMES BALLETTI; FRED T. HARRIS		Report made by [REDACTED] b7C	Type SE
		CHARACTER OF CASE UPUC	

REMARKS

REFERENCES: Report of S [REDACTED] dated 11/10/60 at Salt Lake City. *b7C*

Salt Lake City airtel to Los Angeles, dated 12/17/60, (Inter-office);

Los Angeles airtel to New York, dated 12/22/60, (inter-office).

- RUC -

ADMINISTRATIVE

b7C On 12/21/60 DAN ROWAN, [REDACTED] Los Angeles, California, advised that he has been a personal and close friend of PHYLLIS MC GUIRE of the Mc Guire Singing Act for about two years. ROWAN referred to MC GUIRE as "his girl". During the interview of ROWAN on 12/21/60 at his residence, he received a telephone

Approved <i>[Signature]</i>	Special Agent in Charge	Do not write in spaces below	
Copies made:		139-1201	5
2 - Bureau (AIR MAIL)		REC-23	
2 - Salt Lake City (139-17)(AIR MAIL)		DEC 27 1960	
1 - Miami (Info)(AIR MAIL)			
1 - Chicago (Info)(AIR MAIL)			
1 - Los Angeles (139-77)			

LA 139-77

call from PHYLLIS MC GUIRE in New York City. ROWAN advised MC GUIRE at this time that he was being interviewed by Agents of the FBI in regard to the tapping of his telephone in Las Vegas, Nevada.

DAN ROWAN advised that he did not know SAM GIANCANI and did not know of any particular relationship which existed between PHYLLIS MC GUIRE and GIANCANI now or in the past.

Prior to signing the statement concerning information which he furnished, ROWAN consulted with his attorney by telephone. His attorney advised him that it would be alright for him to sign the statement. ROWAN requested that he be furnished a copy of the statement. A copy of the signed statement is being furnished to ROWAN by letter dated 12/22/60.

- B* -

COVER PAGE

UNITED STATES DEPARTMENT OF JUSTICE
FEDERAL BUREAU OF INVESTIGATION

Copy to:

b7c

Report of:
Date:

[redacted] seb
December 22, 1960

Office: Los Angeles, California

Field Office File No.:

Los Angeles 139-77

Bureau File No.:

Title:

ARTHUR JAMES BALLETTI;
FRED T. HARRIS

Character:

UNAUTHORIZED PUBLICATION AND USE
OF COMMUNICATIONS

Synopsis:

DAN ROWAN, Los Angeles, California, in signed statement 12/21/60, advised he did not give authority to anyone to record telephone calls or install listening devices in his hotel room in Las Vegas, Nevada.

- RUC -

DETAILS:

AT LOS ANGELES, CALIFORNIA

b7c {

On December 21, 1960, DAN ROWAN, [redacted]
[redacted] Los Angeles, California,
was interviewed by SA [redacted] and [redacted]
[redacted]

11/21/60

ROWAN furnished the following signed statement:

LA 139-77

"Los Angeles, California
December 21, 1960

b7C } "I, Dan Rowan, [REDACTED]
[REDACTED] Los Angeles, California, make the
following free and voluntary statement to [REDACTED]
[REDACTED] and [REDACTED] who have
identified themselves as Special Agents of the
FBI. I have been told that I do not have to
make a statement and that any statement I do make,
may be used against me in a court of law. No
threats or promises have been made to induce me
to give this statement, and I have been advised
of my right to consult an attorney.

"About October 26, 1960, I checked in at
the Riviera Hotel, Las Vegas, Nevada and was put
in room #228 or 226.

"About five or six days after checking in at
the Riviera, I was told by the resident manager of
the hotel, that my room was messed up because they
had discovered that the telephone in my room #228 or
226, had been tapped and that a listening device had
been placed on the bed. The manager told me the
Sheriff's Officers arrested an individual in the
lobby of the Riviera named Balletti, who they
had checked at the request of the resident manager.
I was told that Balletti was the person who had been
responsible for the tapping of my phone in room
#228 or 226. At the Sheriff's office in Las
Vegas, Nevada, I signed a complaint against Balletti
concerning the violation for which the Sheriff's Officers had
arrested Balletti.

"On the same day of arrest, which was about
November 1, 1960, at the request of Frank Sennes,
entertainment director at the Riviera, I discussed
the phone tapping incident with Harvey Silbert and
Elias Atoll. Silbert and Atoll are members of the
Corporation which operates the Riviera Hotel.

LA 139-77

After discussing the matter with Silbert, I decided the further pressing of charges against Balletti would inconvenience me and would result in nothing but inconvenience to me. About November 1, 1960, at the Sheriff's Office in Las Vegas, I signed a release and dropped making charges against Balletti.

"I did not give anyone the authority to record telephone calls or to install listening devices in my room #228 or 226, at the Rivera Hotel, Las Vegas, Nevada, on or about October 26, 1960, or at any other time.

b7c "The above statement and the following paragraph is written in the handwriting of Special Agent [REDACTED]. The second, third, fourth and fifth paragraphs were written as told by me and they are true and correct to the best of my knowledge.

"I have initialed each page and the corrections.

"Signed
"/s/ Dan H. Rowan

"Witnesses:

b7c "/s/ [REDACTED] Special Agent, FBI, Los Angeles, Calif.

"/s/ [REDACTED] Special Agent, FBI, Los Angeles, Calif. 12/21/60."

8. 204 12/23/60

FEDERAL BUREAU OF INVESTIGATION
U. S. DEPARTMENT OF JUSTICE
COMMUNICATIONS SECTION

DEC 23 1960
TELETYPE

Mr. Tolson	_____
Mr. Mohr	_____
Mr. Parsons	_____
Mr. Belmont	_____
Mr. Callahan	_____
Mr. DeLoach	_____
Mr. Malone	_____
Mr. McGuire	_____
Mr. Rosen	_____
Mr. Tamm	_____
Mr. Trotter	_____
Mr. W.C. Sullivan	_____
Tele. Room	_____
Mr. Ingram	_____
Miss Gandy	_____

Handwritten initials/signature

Handwritten signature

URGENT 12-23-60 7-13 PM JLD

TO DIRECTOR, FBI 12 AND SAC, SALT LAKE CITY []

FROM SAC, NEW YORK /139-94/

ARTHUR JAMES BALLETTI, FRED T. HARRIS, UPUC. RE SALT LAKE CITY
AIRTEL TWELVE SEVENTEEN LAST. [REDACTED]

b2
b7C
b7D

[REDACTED] ADVISED PHYLLIS MC GUIRE NOW RESIDING APARTMENT
[REDACTED] NYC, TELEPHONE NUMBER
[REDACTED] NUMEROUS ATTEMPTS ARRANGE
INTERVIEW MC GUIRE IGNORED. NAID STATES MC GUIRE TOO BUSY
CHRISTMAS SHOPPING. MC GUIRE NOT PERSONALLY OBSERVED AT

b2
b7D

RESIDENCE TO DATE. [REDACTED]

[REDACTED]

LHD
B6 R

REC-43 137-1201-

DEC 28 1960

NY R 12 WA NSL

EX-117

Handwritten initials/signature

JAN 1 1961

b7D

FEDERAL BUREAU OF INVESTIGATION

Reporting Office MIAMI	Office of Origin SALT LAKE CITY	Date 12/23/60	Investigative Period 12/13/60
TITLE OF CASE CHANGED ARTHUR JAMES BALLETTI; J. W. HARRISON		Report made by [REDACTED]	b7C RKL: [REDACTED]
		SYNOPSIS OF CASE UPUC	[REDACTED]

Synopsis:

The Title of this case has been marked CHANGED to add the name J. W. HARRISON as a subject since BALLETTI claims this was the name of the individual accompanying him in Las Vegas, Nevada.

REFERENCES: Report of SA **[REDACTED]** dated 11/19/60, at Salt Lake City.
Bureau airtel dated 12/8/60.
Miami airtel to the Bureau dated 12/14/60.
Miami airtel to Salt Lake City dated 12/16/60.
Salt Lake City teletype to Miami dated 12/17/60.

- RUC -

LEADS

WASHINGTON FIELD OFFICE: (INFORMATION)

A copy of this report is being submitted for the

Approved L.O. Tenge / RRS	Special Agent in Charge	Do not write in spaces below	
Copies made: 2 - Bureau 3 - Salt Lake City (139-17) (1 - USA, Salt Lake City) 1 - Washington Field (Info) 1 - Miami (139-63)		139-1201-7	ACT-41 REC 5

36
Inc: AAG
Form 6-26
Division
6-22-60

MM 139-63

the information of Washington Field where investigation is being conducted. Washington Field, note Buded is 12/28/60, without fail.

ADMINISTRATIVE

Since the Miami Office has furnished the Salt Lake City Office a photograph of FRED T. HARRIS for display at the Riviera Hotel, Las Vegas, Nevada, the Miami Office is not interviewing HARRIS pending the results of this display.

- B* -

- COVER PAGE -

UNITED STATES DEPARTMENT OF JUSTICE
FEDERAL BUREAU OF INVESTIGATION

Copy to: 1 - USA, Salt Lake City, Utah

Report of: [REDACTED] ^{b7C} Office: Miami, Florida
Date: December 23, 1960

Field Office File No.: Miami 139-63 Bureau File No.:

Title: ARTHUR JAMES BALLETTI;
J. W. HARRISON

Character: UNAUTHORIZED PUBLICATION AND USE OF COMMUNICATIONS

Synopsis: EDWARD L. DU BOIS, Jr., Operator, Investigations, Inc., and employer of ARTHUR JAMES BALLETTI, says he sent BALLETTI to Las Vegas, Nev., for physical surveillance work at the request of ROBERT MAHEU, a private investigator of Washington, D. C. Says purpose of surveillance and identity of MAHEU's client unknown to him. He claims FRED T. HARRIS, another employee, did not go to Las Vegas; that BALLETTI was accompanied by one J. W. HARRISON, who was hired by MAHEU. BALLETTI denies monitoring any phone conversations and claims to know nothing of HARRISON's background. Says Las Vegas authorities mistakenly assumed HARRISON was FRED T. HARRIS.

- RUC -

DETAILS: At Miami, Florida

December 23, 1960
Date _____

EDWARD L. DU BOIS, Jr., was interviewed at Room 412 of the Ainsley Building. This is the Office of an organization known as Investigations, Incorporated, of which DU BOIS is the Director. DU BOIS at the outset of the interview was advised that any information he might give must be in a free and voluntary manner; that he had the right to consult an attorney; that he need not make any statement and any statement he might make could be used against him in a court of law.

DU BOIS said that from time to time in his work as a private investigator, he had handled certain matters for a ROBERT MAHEU, who operates a private investigations organization in Washington, D. C. DU BOIS said in his opinion, MAHEU is a fabulous character who travels extensively and who appears to have a very prosperous business. He said MAHEU's operations often smack of the "cloak and dagger" type of affair and that MAHEU is very close mouthed. He said it was his understanding that MAHEU is now closely associated with HOWARD HUGHES and in addition to offices in Washington, D. C., also maintains offices in Los Angeles, California. DU BOIS stated it is his information that MAHEU has an office at 1125 19th Street, Northwest, Washington, D. C. He said he knows of no address for MAHEU in Los Angeles, but believes he can be reached in Los Angeles at telephone CR 1-8770. He said MAHEU's principle assistant is one WALTER FITZPATRICK, with whom he has also had dealings.

DU BOIS said on October 25, 1960, he received a telephone call from FITZPATRICK in Washington, D. C., asking him to send two men to Las Vegas, Nevada, right away for physical surveillance work. He said FITZPATRICK gave him no further information, did not identify the subject, the purpose of the surveillance, nor the client. DU BOIS said he and his employee ARTHUR JAMES BALLETTI were already scheduled to go to New York for some work and DU BOIS therefore purchased round trip tickets to Las Vegas in the names of FRED T. HARRIS and DICK HUNTER, both of whom are employed by Investigations, Incorporated. DU BOIS said that subsequently, he received another call, this being from

On 12/13/60 at Miami, Florida File # MIAMI 139-63
by SAS [redacted] [redacted] [redacted] Date dictated 12/19/60
[redacted] b7c

MM 139-63

ROBERT MAHEU in Los Angeles. MAHEU instructed DU BOIS to send only one man to Las Vegas and informed him that he had hired one J. W. HARRISON to accompany whoever DU BOIS sent. He said the arrangement was that HARRISON would wait for DU BOIS's man at the Information Counter, Eastern Airlines, Miami International Airport, Miami, Florida. DU BOIS said he then changed his plans and decided to send BALLETTI to Las Vegas and did so on October 26, 1960. He said BALLETTI took with him the tickets in the names of HARRIS and HUNTER and these were used by BALLETTI and HARRISON. DU BOIS said that HARRISON is completely unknown to him and he has never met him. He vigorously denied that HARRIS had gone to Las Vegas with BALLETTI.

DU BOIS said he then went on to New York and the next thing he knew of BALLETTI was when BALLETTI phoned Miami that he had been arrested in Las Vegas as a result of a wire tap. DU BOIS said that BALLETTI had been hired strictly for a physical surveillance and the only piece of equipment he had taken to Las Vegas was a Minifon. DU BOIS said he has never been advised of the purpose of this surveillance at Las Vegas but always assumed that it had something to do with HOWARD HUGHES. He said this was simply an assumption on his part because he believes that MAHEU and HUGHES are rather closely associated. DU BOIS said he has never heard of an individual named SAM GIANCANA.

DU BOIS advised he did not desire to furnish any written statement.

Date December 23, 1960

ARTHUR JAMES BALLETTI was interviewed at Room 412, Ainsley Building, where he is employed by Investigations, Incorporated. BALLETTI was advised that any information he might give must be in a free and voluntary manner; that he had the right to consult an attorney; that he need not make a statement and if he did so it could be used against him in a court of law.

BALLETTI was advised this interview was concerning his activities in Las Vegas, Nevada, in the latter part of October, 1960. He immediately became visibly excited and extremely nervous and stated he would discuss his activities with great reluctance. He said it was very probable that he would refuse to answer many questions.

BALLETTI said that on October 26, 1960, he had flown from Miami, Florida, to Las Vegas, Nevada, on a physical surveillance assignment. He said he had been told to go to Las Vegas by his employer, EDWARD L. DU BOIS, Jr., and it was his understanding that while he was sent there by DU BOIS, he was actually working for some other private investigator who had requested the assistance of DU BOIS. BALLETTI stated he had two round trip tickets to Las Vegas, which were in the names of FRED T. HARRIS and DICK HUNTER. He said that HARRIS and HUNTER are co-workers of his and were originally scheduled to go to Las Vegas but there had been a change in plans. BALLETTI said he went to the Eastern Airlines Desk at the Miami International Airport, Miami, to meet an individual known to him as J. W. HARRISON. BALLETTI said he identified HARRISON from a description previously given him. They flew together to Las Vegas and took room 333 at the Riviera Hotel. On October 28, 1960, they moved to room 331. BALLETTI said that while in Las Vegas, he physically surveilled DAN ROWAN. He said HARRISON apparently put some sort of wire tap in ROWAN's room there, and monitored ROWAN's phone conversations. BALLETTI said he had nothing to do with this tap, did not see it installed, and never did any monitoring. He said that on one occasion while he was downstairs playing black jack, HARRISON phoned him to

On 12/13/60 at Miami, Florida File # MIAMI 139-63
 by SAS [REDACTED] b7C Date dictated 12/19/60

come up to the room. When he did so, HARRISON told him that the recorder was not working and that he had overheard a conversation which he had in his head. HARRISON thereupon related the conversation to BALLETTI who wrote it down on a scratch pad.

BALLETTI said he was never informed of the purpose of this surveillance. He strongly denied that he was accompanied to Las Vegas by FRED T. HARRIS. He said that HARRISON had used the ticket in the name of HARRIS and for this reason the police in Las Vegas apparently assumed that HARRISON was HARRIS. BALLETTI said he never informed the police any different than this and simply told them that his companion was traveling under the name of FRED T. HARRIS. BALLETTI said that HARRISON seldom engaged in any conversation with him and never told him anything of his background nor who had hired him. BALLETTI described HARRISON as follows:

Race	White
Sex	Male
Age	50 years
Height	5'10"
Weight	200 lbs.
Hair	Gray, balding

He said HARRISON left Las Vegas before BALLETTI was arrested on October 31, 1960. BALLETTI said he could not comment on the electronic equipment found in his room, but said he had taken only a Minifon to Las Vegas. BALLETTI furnished the following information concerning himself:

Residence	1420 S. W. 91st Avenue
Unlisted phone	CA 1-1995
Race	White
Sex	Male
Born	1/7/32, at New York City, N.Y.
Height	5'11"
Weight	170 lbs.
Hair	Dark brown
Eyes	Brown
Education	High school
Occupation	Private investigator (About 5 yrs. experience)
Marital status	Married

BALLETTI said he did not desire to furnish a written statement.

MM 139-63

b7c

On December 13, 1960, [REDACTED] Occupational License Bureau, Dade County, Florida, advised that all private investigators in Dade County and Miami, must be registered with his organization and have a license. He said he has no record of any J. W. HARRISON.

Office Memorandum • UNITED STATES GOVERNMENT

TO : Director, FBI (File) DATE: 12/27/60

FROM : SAC, SALT LAKE CITY (File 139-17)

SUBJECT: ARTHUR JAMES GALLETTI
UPUC
(OO: SALT LAKE CITY)

LT

9/10

This case will be delinquent.

Date of Bureau deadline: 12/28/60

Reason for the delinquency: Awaiting completion of investigation of other offices. P report being submitted by Salt Lake City

Date the report or necessary communication will reach the Bureau: 1/4/61

AEC zone designation, e.g., OR, CH, etc.:
(This applies only to 116 cases.)

139-1201-
NOT RECORDED
12 JAN 4 1961

old

62 JAN 5 1961

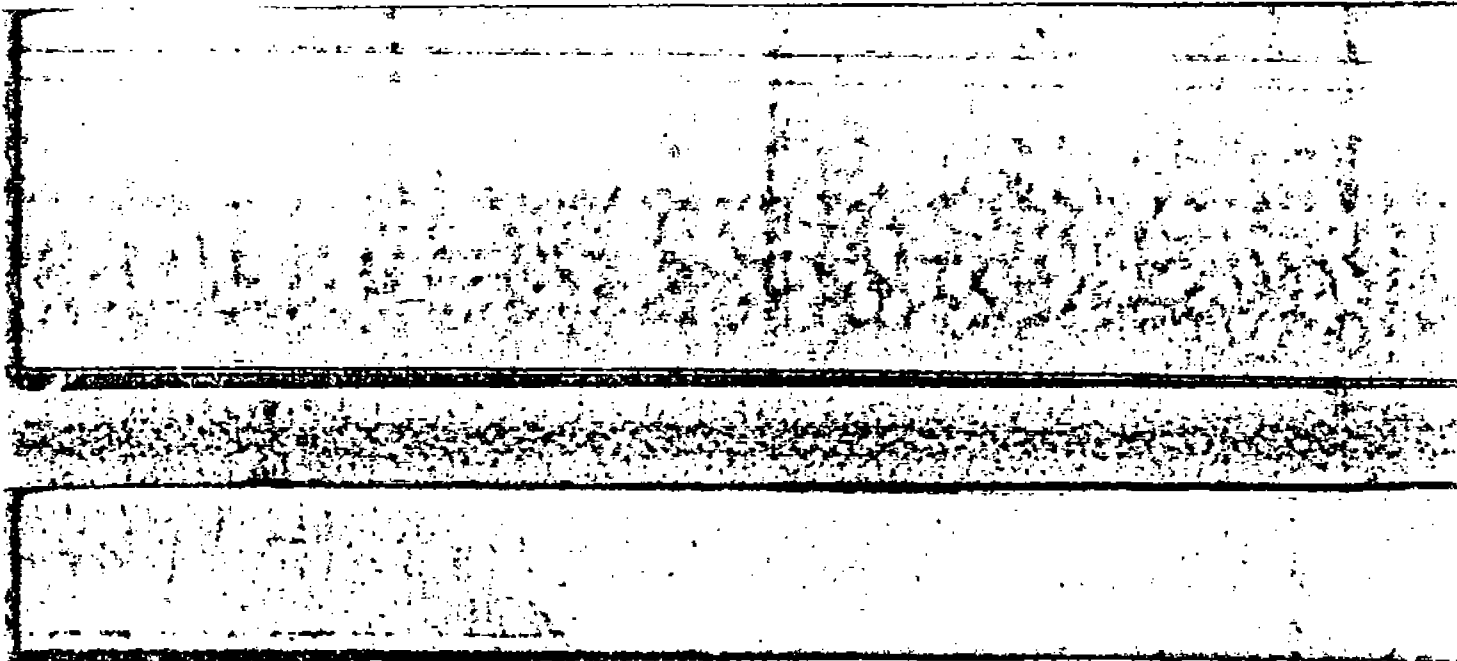

FBI

Date: 12/28/60

Transmit the following in _____
(Type in plain text or code)

Via AIRTEL _____
(Priority or Method of Mailing)

TO : DIRECTOR, FBI
FROM : SAC, NEW YORK (139-94)
SUBJECT : ARTHUR JAMES BALLETTI;
FRED T. HARRIS
UPUC

1-5

ReNYtel to Bureau, 12/23/60.

PHYLLIS MC GUIRE contacted NYO via long distance telephone on 12/28/60, advising she would be in NY on or about 1/2/61, at which time she would communicate again with the NYO, and set time for interview. Miss MC GUIRE apologized for not having contacted the NYO earlier, as requested, but declined to furnish location from which she was making the long distance telephone call.

[REDACTED] learned that SAMUEL M. GIANCANA is believed to be in Miami, Florida, and has planned on being in NY about 1/3/61, prior to his return to Chicago on 1/5/61.

b2
b7C
b7D

In view of GIANCANA's past association with MC GUIRE, this information is being set forth for the information of the Miami Office in event information is developed to the effect GIANCANA and MC GUIRE are together in that area.

- 3 - Bureau 1cc - T.
- 1 - Chicago (Info.)
- 1 - Miami (Info)
- 2 - Salt Lake City
- 1 - New York
- 1 - New York
- 1 - New York (92-583)

b2
b7D

REC-7

139-1201-8

K

JPF:RM
(8)

EX-111

DEC 30 1960

Approved: _____ Sent _____ Per _____
Special Agent in Charge

SIX

F B I

Date: 1/3/61

PLAIN TEXT

Transmit the following in _____
(Type in plain text or code)

Via AIRTEL _____
(Priority or Method of Mailing)

TO: DIRECTOR, FBI
FROM: SAC, NEW YORK (139-94)
SUBJECT: ARTHUR JAMES BALLETTI
UPUC

DP /

Re NY airtel to Bureau, 12/28/60.

On 1/2/61, PHYLLIS MC GUIRE was interviewed at her apartment [redacted] by SAS [redacted] and [redacted], at which time she stated that she had not given authority to anyone to install a listening device on DAN ROWAN at any time and had no prior knowledge that such a device had been in use prior to the arrest of BALLETTI.

Enclosed are nine copies of FD 302 for Salt Lake City Office reflecting interview of PHYLLIS MC GUIRE above.

Rec

- 3 - Bureau
- 1 - Chicago (Info)
- 2 - Salt Lake City (139-17) (Encls. 9)
- 1 - New York (92-793)
- 1 - New York (139-94)

REC-21 139-1201-

JAN 4 1961

JPF:jc
(10)

JAN 18 1961

[Handwritten signature]

C C - War

Approved: _____ Sent _____ M Per _____
Special Agent in Charge

FEDERAL BUREAU OF INVESTIGATION

REPORTING OFFICE SALT LAKE CITY	OFFICE OF ORIGIN SALT LAKE CITY	DATE 12/30/60	INVESTIGATIVE PERIOD 12/15/60 - 12/22/60
TITLE OF CASE "CHANGED" ARTHUR JAMES BALLETTI; UNKNOWN SUBJECT, aka J. W. Harrison		REPORT MADE BY [REDACTED] b7C	TYPED BY czw
		CHARACTER OF CASE UPUC	

~~XXXXXX~~ The title is marked changed to add UNKNOWN SUBJECT, aka J. W. Harrison as subject. *b7C*

REFERENCES Report of SA **[REDACTED]** dated 11/10/60 at Salt Lake City.

Bureau airtel to Salt Lake City dated 12/8/60.

Salt Lake City airtel to Los Angeles dated 12/17/60 (Interoffice)

Miami airtel to Bureau dated 12/14/60.

Miami airtel to Salt Lake City dated 12/16/60 (Interoffice).

- P -

LEADS

CHICAGO DIVISION (INFORMATION)

One copy is being furnished Chicago since investigation may be requested of that Division.

APPROVED <i>[Signature]</i>	SPECIAL AGENT IN CHARGE	DO NOT WRITE IN SPACES BELOW	
COPIES MADE: <ul style="list-style-type: none"> (2) Bureau 1- USA, Reno 1- Chicago (Info) 2- New York 2- Washington Field Office 3- Salt Lake City (139-17) 		137-1201-10	REC-91
		15 JAN 18 1961 <i>[Signature]</i>	
<u>Dissemination Record of Attached Report</u>		<u>Notations</u>	
Agency		<i>[Handwritten notes]</i> Bureau 1-5-61 EJP: gpa	
Request Recd.			
Date Fwd.			
How Fwd.			
By	<i>[Signature]</i>		

50 JAN 13 1961

UNITED STATES DEPARTMENT OF JUSTICE
FEDERAL BUREAU OF INVESTIGATION

1- USA, Reno

Copy to:

Report of:

Date:

Field Office File #:

Title:

[REDACTED] b7c
12/30/60

Salt Lake City 139-17

ARTHEUR JAMES BALLETTI;
UNKNOWN SUBJECT, aka J. W. Harrison

Office:

Salt Lake City, Utah

Bureau File #:

Character:

UNAUTHORIZED PUBLICATION AND
USE OF COMMUNICATIONS

Synopsis:

BALLETTI charged by State of Nevada with three counts--invasion of privacy, a felony, other two charges misdemeanors--for alleged "recording of telephone conversations" of DAN ROWAN and PHYLISS MC GUIRE. All items seized at time of arrest of BALLETTI except two cameras will be retained by Clark County Sheriff's Office until conclusion of trial of BALLETTI. BALLETTI on interview denies monitoring telephone conversation and claims individual who traveled to Las Vegas with him used name HARRISON and actual identity unknown to BALLETTI. AUSA, Las Vegas, desires results of all investigation prior to rendering opinion and advised facts will probably be presented to Federal Grand Jury, at Las Vegas.

- P -

DETAILS:

By communication dated December 17, 1960, the Los Angeles and New York Divisions were requested to interview DAN ROWAN and PHYLISS MC GUIRE, parties to the telephone calls which were allegedly intercepted.

By communication dated December 14, 1960, the Miami Division advised Former Special Agent EDWARD DU BOIS, who is head of Investigations, Inc., Miami, on interview says he received a phone call October 25, 1960, from WALTER FITZPATRICK, representing ROBERT MALESU, a private

SJ 139-17

NEW YORK DIVISION

Immediately furnish results of your investigation in order matter can be presented to U. S. Attorney.

WASHINGTON FIELD OFFICE

Immediately furnish results of investigation requested in Miami airtel to Bureau dated 12/14/60. Bureau has instructed that leads be handled promptly.

SALT LAKE CITY DIVISION

AT LAS VEGAS, NEVADA

Upon receipt of all outstanding investigation present facts to U. S. Attorney, Las Vegas.

Continue to attempt to develop facts which might indicate identity of person at Riviera Hotel with BALLETTI who used name J. W. HARRISON.

- B* -
COVER PAGE

investigator at 1125 19th Street, Northwest, Washington, D.C. FITZPATRICK wanted DU BOIS to send two men to Las Vegas for surveillance work, purpose not explained. DU BOIS purchased tickets in the name of DICK HUNTER and FRED T. HARRIS, both of whom are former Special Agents and employees of DU BOIS. DU BOIS received subsequent call either from FITZPATRICK or from ROBERT MANEU in Los Angeles advising DU BOIS to send only one man to Las Vegas. The caller instructed that a second man had been hired and would be at the Eastern Airlines information window, Miami International Airport. DU BOIS then sent BALLETTI to Las Vegas, and he was accompanied by the man hired by MANEU, who identified himself as J. W. HARRISON.

BALLETTI, on interview at Miami, denies monitoring any phone conversations and can furnish no background information regarding HARRISON. He says HARRISON was traveling on a ticket of FRED T. HARRIS and for this reason the Las Vegas Sheriff's Office erroneously assumed HARRISON was HARRIS.

BALLETTI described J. W. HARRISON as follows:

Race	White
Sex	Male
Age	50
Height	5 feet 10 inches
Weight	200 pounds
Hair	Brown, balding

Date 12/22/60

[REDACTED]

Clark County Sheriff's Office, advised on December 12, 1960, that ARTHUR JAMES BALLETTI, who was arrested on October 31, 1960, had been released on the same date on \$2,000.00 bond. He advised that BALLETTI has been charged with (1) Invasion of Privacy, a felony; (2) Possession of burglary tools, a misdemeanor; and (3) Operating as a Private Detective without a license, a misdemeanor. Preliminary hearing on these charges has been set for April 24, 1961, in Justice of the Peace Court, Las Vegas.

b7c { [REDACTED] stated that all articles obtained at the time of arrest of BALLETTI had been booked in by the Sheriff's Office as evidence and would be retained by that department until conclusion of the trial of BALLETTI on the above listed state charges. He stated that the only items not retained by the Sheriff's Office was the Minox camera and thirty-five millimeter camera.

[REDACTED] stated that the Minifon recorder contains one partially used roll of wire which contains what is possibly a recording of a telephone call.

[REDACTED] also advised that his department has part of an interview with BALLETTI recorded on tape which will be retained until conclusion of state charges against BALLETTI.

[REDACTED] advised that film in the Minox camera had been developed and among other pictures were two photos of a person who appeared to be DAN ROWAN on a golf course.

On 12/20/60 at Las Vegas, Nevada File # SALT LAKE CITY 139-17
 by SA [REDACTED] 67C Date dictated 12/22/60

Date 12/29/60

b7C [REDACTED] Trans World Airlines,
Las Vegas, advised that records of that company reflect
that one F. T. HARRIS departed Las Vegas on Trans World
Airlines Flight 292 at 10:30 AM on October 30, 1960, to
St. Louis, Missouri, where he made connections with
Trans World Airlines Flight 76 to Miami, Florida. Reservations
were made around 12:00 PM on October 29, 1960, and Las
Vegas contact given by person making reservations was Room 331,
Riviera Hotel.

On 12/22/60 at Las Vegas, Nevada File # SALT LAKE CITY 139-1
by b7C SA [REDACTED] hzw Date dictated 12/22/60

This document contains neither recommendations nor conclusions of the FBI. It is the property of the FBI and is loaned to your agency; it and its contents are not to be distributed outside your agency.

Date 12/25/60

b7c
b7D

[redacted] Riviera Hotel, was contacted, and nine photographs, including a photograph of FRED T. HARRIS, were exhibited. He advised that he could not identify anyone whose photo had been exhibited as being identical with the individual who checked into the hotel on October 26, 1960, under the name J. W. HARRISON.

[redacted] stated that he did not think he would recognize either BALLETTI or HARRISON if he should see them in person.

On 12/22/60 at Las Vegas, Nevada File # SALT LAKE CITY 139-
by SA [redacted] /dzw Date dictated 12/22/60

This document contains neither recommendations nor conclusions of the FBI. It is the property of the FBI and is loaned to your agency; it and its contents are not to be distributed outside your agency.

Date 12/29/60b7C
b7D

On December 21, 1960, [REDACTED] Clark County Sheriff's Office, Las Vegas, Nevada, furnished the following list of articles in possession of ARTHUR JAMES BALLETTI at the time of his arrest by the Clark County Sheriff's Office on October 31, 1960 at Las Vegas, Nevada:

One AM-FM Sony transistor radio, serial number 1943, found next to dresser in Room 331.

One telephone bug transmitter, recovered from behind the bed in Room 223.

One yellow pad recovered from dresser, Room 331.

Recovered from a blue Travel-Joy suitcase in Room 331

Seventeen lock picks in brown leather case

One General transistor 6, type 66770

One roll of blue wire

One ear phone

Two telephone bug devices

One green leather case containing two wall type room bugs, one phone jack with ear plugs.

One three way socket

One roll copper wire

One Pronona battery charger, NF55D

One roll of mastic tape

One roll of black friction tape

On 12/21/60 at Las Vegas, Nevada File # SALT LAKE CITY 139-17
by SA [REDACTED] dzw b7C Date dictated 12/22/60

SU 139-17

One transistor ear plug
One Roger Slide cigarette case containing a miniature transmitt
One brown extension cord
One black two-jack wire
One tube of "goo" all-purpose adhesive
One black two-jack wire
One red two-jack wire
One pocket type flash light
One white wire with two alligator clips
One Mallory Mercury transistor battery
One one eighth inch screw driver
One cloth tape measure
One Beach Tower room key, Miami Beach
One large screw driver, yellow handle
One booster tube
One six inch metal ruler
One two pointed needle-nosed punch
One Minox camera and brown case
Two 8.4 Everready transistor radio batteries
One wall Micro phone
One Kodak Tri-x 35 mm 20 exposure film
Two rolls of 24 one fourth pound wire
One Minox film

SU 139-17

Two rolls 2-strand gray speaker wire

One small piece of red speaker wire

One piece of speaker wire containing alligator clip on one end, jack on other

One Kraeuter electrical pliers

One adjustable wrench

One small metal wire

One radio screw driver

One paint brush

One small screw driver

Seventeen door shims, plastic

Two transistor radio batteries, Mallory TR 140R 9 volt

One Minifon battery 12 volt

Five Mallory Mercury transistor radio batteries, 7.5 volt TR 145R

One roll SL 120 minifon wire

One Gem razor blade

One Dutch master cigar box

Five business cards from Investigator's Inc., 412 Ainsley Building, Miami 32, Florida, telephone FR -14751.

One Herald battery tester

One Minifon tape recorder, serial 929724, containing one partially used roll of wire

Date 12/29/60

[redacted] Riviera Hotel, Las Vegas, Nevada, advised that records of that hotel, Registration Card No. 192569, reflects that DAN ROWAN, [redacted] California, checked into the Riviera Hotel on October 26, 1960, and checked out on November 10, 1960. He was assigned Room 223.

[redacted] record of long distance calls made by ROWAN, Room 223:

<u>TICKET NUMBER</u>	<u>DATE</u>	<u>NUMBER CALLED</u>	<u>TIME</u>	<u>MINUTE TALKED</u>
----------------------	-------------	----------------------	-------------	----------------------

b7C

[redacted table content]

[redacted] most of the calls had apparently been made by DAN ROWAN of the team of Martin and Rowan, to PHYLISS MC GUIRE of the Mc Guire Sisters singing act.

[redacted] stated that Riviera Hotel Registration Card No. 192533 reflects that one ARTHUR J. BALLETTI, Kenmore Street, Los Angeles, California, had checked into that hotel at 5:35 PM on October 26, 1960, and was assigned to Room 331. He checked out at about 9:32 AM on November 1, 1960. This card bears the notation "in room with HARRISON." The records reflect that he was charged for six local calls, numbers called not available.

On 12/21/60 at Las Vegas, Nevada File # SALT LAKE CITY 139-1
by SA [redacted] dzw Date dictated 12/23/60

[redacted] stated that Riviera Hotel Registration Card No. 192650 reflects that J. W. HARRISON, 214 West Water Street, San Francisco, California, checked in at 5:35 PM on October 26, 1960. He was first assigned to Room 333, but was subsequently moved to Room 331 with BALLETTI. No date was shown for checkout.

[redacted] stated he did not see the person who checked in using the name of HARRISON. [redacted] stated that [redacted] checked in both BALLETTI and HARRISON.

[redacted] stated that it is his normal procedure when a hotel bill amounts to an excess of \$100.00, if the person is not known or has not established credit, to call on a hotel guest for payment on the hotel bill. The guests in Room 331 had not paid anything on their bill which by October 31, 1960, had exceeded \$100.00. [redacted]

[redacted] and [redacted] went to Room 331 and no one was in the room. [redacted] and [redacted] entered the room to ascertain if the guests had skipped. [redacted] observed a yellow pad in the room with a notation of time, and date which referred to DAN ROMAN. [redacted] looked around the room and in a top desk drawer observed what appeared to him to be a recording device.

[redacted] and [redacted] left the room having gone there around 11:00 AM. [redacted] left word with the maid to notify him when the guests returned. [redacted] was notified and with [redacted] they returned to Room 331 about 1:00 PM.

[redacted] asked BALLETTI about the bill and BALLETTI stated it would be paid and that he would stay a few more days. He had bandages on both hands, and [redacted] asked about the bandages. BALLETTI had seen the hotel doctor, a Dr. CHERRY, and he had a skin allergy.

[redacted] asked for identification, and BALLETTI exhibited some type of identification not now recalled by [redacted] - either an American Express or Diners Club Credit Card. When the card was exhibited, BALLETTI held his finger over the address.

BALLETTI told [REDACTED] he had money in the casino cashier's cage. [REDACTED] later checked the cage, and ascertained that BALLETTI did have an envelope there, but [REDACTED] did not ascertain its contents.

[REDACTED] advised he notified the Clark County Sheriff's Office that he had observed what appeared to be a recording device in BALLETTI's room and suspected that in view of the fact he had observed the notation on the pad of the name of ROWAN, that a listening device might be installed in ROWAN's room.

b7c
After an unsuccessful attempt to locate ROWAN, [REDACTED] accompanied Deputy Sheriff [REDACTED] and another unrecalled deputy into ROWAN's room. [REDACTED] observed what appeared to be some type of microphone taped to the rear headboard on the bed in ROWAN's room with wires running to the telephone wall box. [REDACTED] observed the deputy sheriff remove the article from the headboard.

Around 4:00 PM on October 31, 1960, DAN ROWAN returned to the hotel and was instructed by [REDACTED] to contact the Clark County Sheriff's Office.

SU 139-17

This matter was discussed with Assistant U. S. Attorney RAYMOND SUTTON, Las Vegas, Nevada, on December 22, 1960, and he advised that he desired to have the results of full investigation prior to rendering a prosecutive opinion. Mr. SUTTON stated, however, that upon receipt of results of full investigation, he would in all probability present the matter to the next Federal Grand Jury which meets in Las Vegas.

FEDERAL BUREAU OF INVESTIGATION

Reporting Office WASHINGTON FIELD	Office of Origin SALT LAKE CITY	Date 1/12/61	Investigative Period 12/27/60
TITLE OF CASE ARTHUR JAMES BALLATTI; UNSUB; aka J.W. Harrison		Reported By [REDACTED]	Typed By RF
		CHARACTER OF CASE UPUC	

Special Agent
XXXX

REFERENCE

b7C Maintel to Director, 12/14/60 and report of SA [REDACTED] dated 12/30/60 at Salt Lake City.

- RUC -

Approved <i>[Signature]</i>	Special Agent in Charge	Do not write in spaces below			
Copies made: <ul style="list-style-type: none"> (2) - Bureau 3 - Salt Lake City (139-17) (1 - USA, Reno, Nevada) 1 - Miami (139-63) (Info) 1 - Washington Field (139-61) 		137	1391	11	2
		6 JAN 11 1961			
		REC-1			

- A* -
COVER PAGE

UNITED STATES DEPARTMENT OF JUSTICE
FEDERAL BUREAU OF INVESTIGATION

Copy to: 1 - USA, Reno, Nevada

Report of: [REDACTED] b7c
Date: 1/12/61

Office: Washington, D.C.

Field Office File No.: 139-61

Bureau File No.:

Title: ARTHUR JAMES DALLATTI;
UNSUB; aka J.W. Harrison

Character: UNAUTHORIZED PUBLICATION AND USE OF COMMUNICATIONS

Synopsis:

ROBERT MAHEU, MAHEU and KING Associates, Inc., recommended EDWARD DU BOIS, Investigations, Inc., Miami, Florida, to a Los Angeles, California, attorney. MAHEU called DU BOIS at attorney's request. MAHEU denies making arrangements with DU BOIS and hiring of J. W. HARRISON. MAHEU does not know HARRISON or DALLATTI. MAHEU would not furnish identity of Los Angeles attorney without attorney's consent.

- RUC -

Date 1/4/61

ROBERT MAHEU, MAHEU and KING Associates, Incorporated, 1125 19th Street, N.W., advised that he recalled that during October, 1960, he received a telephone call from a Los Angeles, California, attorney asking MAHEU to recommend someone who could do some investigative work in Las Vegas, Nevada, for a client. MAHEU stated that he recommended to this attorney EDWARD DU BOIS, Investigations, Incorporated, Miami, Florida. He stated that the Los Angeles attorney requested him to contact DU BOIS and to make the necessary arrangements to handle the investigation in Las Vegas.

MAHEU stated that he could not recall if he or WALTER FITZPATRICK, an associate of MAHEU, had contacted DU BOIS regarding this request. He stated that his firm was not involved in this matter and that DU BOIS had been contacted only as a favor to the Los Angeles attorney.

MAHEU denied that he had made a second call to DU BOIS instructing DU BOIS to send only one man to Las Vegas. He further stated that he had not hired J. W. HARRISON to accompany whoever DU BOIS sent to Las Vegas. MAHEU stated that he does not know a J.W. HARRISON and is not acquainted with ARTHUR JAMES BALLETTI.

MAHEU stated that he did not desire to furnish the identity of the Los Angeles attorney who originally contacted him without the consent of the attorney.

On 12/27/60 at Washington, D.C. File # WFO 139-61
 by SA [REDACTED] /rr b7c Date dictated 12/30/60

This document contains neither recommendations nor conclusions of the FBI. It is the property of the FBI and is loaned to your agency; it and its contents are not to be distributed outside your agency.

FEDERAL BUREAU OF INVESTIGATION
U. S. DEPARTMENT OF JUSTICE
COMMUNICATIONS SECTION

JAN 17 1961

TELETYPE

Mr. Tolson	_____
Mr. Mohr	_____
Mr. Parsons	_____
Mr. Belmont	_____
Mr. Callahan	_____
Mr. DeLoach	_____
Mr. Malone	_____
Mr. Rosen	_____
Mr. Sullivan	_____
Mr. Tavel	_____
Mr. Trotter	_____
Mr. Tele. Room	_____
Miss Gandy	_____

Mc Donogh

URGENT 1-17-61 11-26 AM MST GPF
TO DIRECTOR, SAC, WFO 139-61, SAC, MIAMI 139-638
FROM SAC, SALT LAKE CITY 139-17

ARTHUR JAMES BALLETTI., UNSUB, AKA J. W. HARRISON, UPUC, OO SALT
LAKE CITY. REREP SA [REDACTED] TWELFTH INSTANT AT WFO.
WFO IMMEDIATELY REINTERVIEW ROBERT MAKEU AND ATTEMPT ASCERTAIN
IDENTITY OF LOS ANGELES ATTORNEY MENTIONED REREP. IN EVENT
MAKEU

REFUSES TO FURNISH NAME OF ATTORNEY ADVISE HIM OF POSSIBILITY
HE WILL BE SUBPOENAED TO TESTIFY BEFORE FGJ. LAS VEGAS. ADVISE LOS
ANGELES, SALT LAKE CITY, AND MIAMI RESULTS OF YOUR INQUIRY.
MIAMI REINTERVIEW EDWARD L. DU BOIS RE INFORMATION FURNISHED BY
MAKEU IN REREP. MIAMI NOTE DU BOIS MAY ALSO BE SUBPOENAED BEFORE
FGJ. LAS VEGAS. INTERVIEW FRED T. HARRIS TO DETERMINE IF HE WAS
INDIVIDUAL IN LAS VEGAS WITH BALLETTI. BOTH OFFICES EXPEDITE
IN COMPLIANCE WITH BUREAU INSTRUCTIONS AND SUREP. LOS ANGELES
ADVISED AM.

END CORR MM FILE NO
55 JAN 25 1961
156 339-63

Called Wash. Field *6*
M
By

END WA 1-30 PM OK FBI WA JSA
MM OK FBI MM CO

TWO COPIES WFO

TELETYPE

1/27/61

AIRTEL

To: SAC, Washington Field (139-61)
Miami (139-63)

From: Director, FBI

ARTHUR JAMES BALLETTI
UNKNOWN SUBJECT
UPUC
OO: SU

er,

ReSutel 1/17/61.

Immediately advise results of requested interviews and sureps. Matter must be given prompt and vigorous attention. If reports already submitted, advise dates and names of reporting Agents.

1 - Salt Lake City (Info) (139-17)

EJM:aeo
(7)

REC-16

[Handwritten signature]

139-1201-13

19 JAN

MAILED 27
JAN 27 1961
COMM-FBI

7 265
52 JAN 21 1961

[Handwritten signature]

MAIL ROOM TELETYPE UNIT

FBI

Date: 1/30/61

Transmit the following in _____
(Type in plain text or code)

Via AIRTEL _____
(Priority or Method of Mailing)

TO: DIRECTOR, FBI
FROM: SAC, WFO (139-61)
ARTHUR JAMES BALLETTI; UNSUB
UPUC
OO: SLC

mjm
5/7

L
1

Re Salt Lake City tel 1/17/61, Buairtel 1/27/61.

ROBERT MAHEU, MAHEU and KING ASSOCIATES, INC., 1125 19th St., N.W. advised 1/19/61 he would attempt to secure permission from the attorney in Los Angeles to furnish his name to the FBI for interview. On 1/27/61, efforts were made to contact MAHEU and as he was not in his office, word was left to have him contact WFO.

On 1/30/61, ROBERT MAHEU telephonically contacted WFO and advised he had been in touch with the attorney in Los Angeles by phone but attorney did not desire to have his name furnished to the FBI. MAHEU advised he is leaving on 1/30/61 to go to Los Angeles and while there will talk further with the attorney in an attempt to secure permission to furnish his name to the Bureau. It was suggested to MAHEU that upon receipt of this permission, that MAHEU contact the Los Angeles Office but he stated he is returning to WDC within a few days and will furnish the information upon his return. He stated in the event he is delayed in returning to WDC, he will telephonically contact WFO from Los Angeles. MAHEU stated he "is in the middle on this thing" as he is "the only person who knows the attorney's name". He stated he will make every effort to secure the permission of the attorney to divulge his name and furnish it to WFO.

P

- 3 Bureau
- 2 Salt Lake City (139-17) AM
- 1 Miami (Info) (139-63)
- 1 WFO
- CWB:VIM

MW
REC-68 *139-1301-14*

59 FEB 2 1961

10 JAN 30 1961

FEDERAL BUREAU OF INVESTIGATION

REPORTING OFFICE MIAMI	OFFICE OF ORIGIN SALT LAKE CITY	DATE JAN 28 1961	INVESTIGATIVE PERIOD 1/18 - 25/61
TITLE OF CASE ARTHUR JAMES BALLETTI; UNSUB, aka J. W. Harrison.		REPORT MADE BY [REDACTED] b7C	TYPED GK
		CHARACTER OF CASE UPUC.	

REFERENCES: Report of SA [REDACTED] dated 1/12/61, at Washington Field;
Salt Lake City teletype to Director, Washington Field and Miami 1/17/61;
Miami teletype to Salt Lake City 1/17/61; and,
Salt Lake City teletype to Miami 1/18/61.

- P -

LEADS

LOS ANGELES:

AT LOS ANGELES, CALIFORNIA

Determine listing for telephone CR 1-8770 where ROBERT MAHEU was reached by EDWARD L. DUBOIS immediately after BALLETTI's arrest. If this number is listed to an attorney, he should be interviewed for any information concerning this matter, bearing in mind

APPROVED <i>[Signature]</i>	SPECIAL AGENT IN CHARGE	DO NOT WRITE IN SPACES BELOW	
COPIES MADE:		139-1731-15	
2 - Bureau (117) 3 - Salt Lake City (139-17) (1 - USA, Salt Lake City) 2 - Los Angeles 2 - Washington Field (139-61) 2 - Miami (139-63)		JAN 28 1961 10 10	
Dissem. Record of Attached Report		Notations	
Agency	Request Recd.	<i>[Handwritten Notations]</i>	
Date Fwd.	How Fwd.		
By			
Form 6-94# 2-12-61			

MM 139-63

that he might possibly be MAHEU's client.

SALT LAKE CITY:

AT LAS VEGAS, NEVADA

Determine identity of attorney who represented BALLETTI, and through him attempt to learn what Los Angeles attorney contacted him, noting such attorney may possibly be the client of ROBERT MAHEU.

WASHINGTON FIELD:

AT WASHINGTON, D. C.

Attempt to determine identity of J. A. ROLLINS who was at the Kenilworth Hotel, Miami Beach, with ROBERT MAHEU during the latter part of October, 1960. It appears probable that ROLLINS is an employee of MAHEU and he should be interviewed to determine if he is the individual who accompanied BALLETTI to Las Vegas.

MIAMI:

AT MIAMI BEACH, FLORIDA

Will recontact the Kenilworth Hotel in an effort to determine long distance calls made by MAHEU during October, 1960.

- B* -

- COVER PAGE -

UNITED STATES DEPARTMENT OF JUSTICE
FEDERAL BUREAU OF INVESTIGATION

Copy to: 1 - USA, Salt Lake City

Report of:

Date:

[REDACTED] b7C
JAN 28 1961

Office:

MIAMI, FLORIDA

Field Office File #: 139-63

Bureau File #:

Title:

ARTHUR JAMES BALLETTI

Character:

UNAUTHORIZED PUBLICATION
AND USE OF COMMUNICATIONS

Synopsis:

FRED T. HARRIS denies traveling to Las Vegas, Nev., with ARTHUR JAMES BALLETTI and says he was not employed by EDWARD L. DUBOIS in 10/60. HARRIS says only knowledge he has of instant matter is from reading news article concerning BALLETTI's arrest at Las Vegas. EDWARD L. DUBOIS denies that HARRIS accompanied BALLETTI to Las Vegas; denies knowing identity of J. W. HARRISON; and, says HARRISON was hired by ROBERT MAHEU who was at Miami Beach during pertinent period. Records of Kenilworth Hotel, Miami Beach, reflect ROBERT A. MAHEU registered there from 10/11-29/60. Was accompanied by one J. A. ROLLINS, who was registered 10/11-30/60.

- P -

DETAILS:AT MIAMI, FLORIDA

FEDERAL BUREAU OF INVESTIGATION

Date January 25, 1961

Fred T. Harris
 FRED T. HARRIS, 885 N. W. 17th Place, appeared at the Miami Office. HARRIS was advised that he had the right to an attorney, that he did not have to make any statement, and that any statement he made could be used against him in a court of law.

HARRIS said that he has formerly worked as a private investigator for a Miami organization known as Investigations, Inc. He said that the Director of this organization is EDWARD L. DUBOIS, JR. HARRIS said that in June, 1960, he became a field underwriter for Mutual of New York, and from June until November 16, 1960, he did not work for DUBOIS. He said that during this period he had an understanding with DUBOIS that he could be called for any special short assignments. He said that since November 16, 1960, he has been back with DUBOIS almost full time, although he writes life insurance on the side.

HARRIS said that in the first part of November, 1960, he read an article in a Miami paper reporting that ARTHUR JAMES BALLETTI had been arrested at Las Vegas, Nevada, as a result of a wire tap. HARRIS said he was acquainted with BALLETTI and the article was of some interest to him. HARRIS said he definitely had not accompanied BALLETTI to Las Vegas and knew nothing of this affair other than what he had read in the paper. He was not aware that anyone had gone to Las Vegas with BALLETTI, and added that the name J. W. HARRISON means nothing to him.

HARRIS said that while he could not pinpoint his complete activities, he was certain that he was never out of Miami during the period from October 26 through 30, 1960. He said he also wished to point out that he knows nothing of electronic devices, has never had any sound training, and would have no idea as to how to install any sort of wire tap.

HARRIS said that sometime after he had read of BALLETTI's arrest, he had asked DUBOIS about it, but DUBOIS

- 2 -

On 1/24/61 at Miami, Florida File # Miami 139-63

by Special Agent [REDACTED] b7C :GK Date dictated 1/25/61

MM 139-63

had refused to discuss the matter, simply telling HARRIS there was no need for him to know anything about it.

The following description of HARRIS was obtained from observation and interrogation:

White; male; born, April 20, 1923, at Detroit, Michigan; 5 feet 10½ inches; 175 pounds; black hair; blue eyes.

FEDERAL BUREAU OF INVESTIGATION

Date January 25, 1961

EDWARD L. DUBOIS, JR. was interviewed at Room 412, Ainsley Building, which is the office of Investigations, Inc. of which DUBOIS is the Director. DUBOIS was advised that he did not have to make any statement; that he had the right to an attorney; and, any statement he made could be used against him in a court of law.

Miami, Fla. N.Y.
DUBOIS said it was his recollection that on October 25, 1960, he received a call from WALTER FITZPATRICK, who is an assistant to ROBERT MAHEU, a Washington, D. C. private investigator. FITZPATRICK told him that MAHEU wanted DUBOIS to have two men in Las Vegas, Nevada, by the following day for physical surveillance work. FITZPATRICK also said that MAHEU was traveling, but would call DUBOIS as soon as he got settled down some place.

DUBOIS said that he and his employee, ARTHUR JAMES BALLETTI were scheduled to go to New York City for some investigative work, and he therefore purchased round trip tickets to Las Vegas in the names of FRED T. HARRIS and DICK HUNTER, both of whom have been employed by Investigations, Inc. DUBOIS said it was his recollection that later on the same day he received a telephone call from MAHEU who said he was at the Kenilworth Hotel, Miami Beach. At this time MAHEU said DUBOIS should only send one man to Las Vegas since he, MAHEU, had hired a second man who would be at the information desk, Eastern Airlines, Miami International Airport. DUBOIS said that in view of this, he altered his plans and left for New York alone that same evening. He gave the two round trip tickets to BALLETTI who went to the airport, met MAHEU's man, and traveled to Las Vegas using the HARRIS and HUNTER tickets.

DUBOIS said that FRED HARRIS definitely did not accompany BALLETTI to Las Vegas and, in fact, HARRIS did not work for him from June until the middle of November, 1960. He said he had an understanding with HARRIS that he could be

- 4 -

On 1/24/61 at Miami, Florida File # Miami 139-63

by Special Agents [REDACTED] and [REDACTED] Date dictated 1/25/61

MM 139-63

called for emergency use, but he had not been used. DUBOIS said that whoever accompanied BALLETTI was definitely not an employee of his, and he knew no one named J. W. HARRISON. He said he assumed that HARRISON was a fictitious name, probably derived from the name HARRIS on the airline ticket. DUBOIS said he had no idea who had hired MAHEU for this work in Las Vegas, and commented if he did know, he would not feel free to disclose it. He also said that he has received one thousand dollars from MAHEU for BALLETTI's services in Las Vegas.

DUBOIS advised that while he was in New York, he read of BALLETTI's arrest at Las Vegas and immediately attempted to contact MAHEU in Washington, D. C. He said he was unable to reach MAHEU there, but as a result of inquiries finally reached him in Los Angeles at telephone CR 1-8770. He stated when he talked with MAHEU he was advised that MAHEU knew of BALLETTI's arrest and had arranged for a Las Vegas attorney to defend him. MAHEU indicated that he had made these arrangements through a Los Angeles attorney whose identity he did not disclose. DUBOIS said he had no further knowledge concerning this matter, and did not desire to furnish any written statement.

DUBOIS commented that when previously interviewed, he was confused as to the origin of the call he had received from MAHEU and thought it had been from Los Angeles. He said that upon reflection he is now certain the call came from Miami Beach and he had apparently confused that call with his call from New York to Maheu in Los Angeles.

Date January 25, 1961

b7c
 [REDACTED] desk clerk, Kenilworth Hotel, advised her registration records reflect that ROBERT A. MAHEU, 1125 - 19th Street, N.W., Washington, D. C., was registered in Room 722 at \$11.00 per day, from October 11 - 29, 1960. He was accompanied by one J. A. ROLLINS, 1125 - 19th Street, N.W., Washington, D. C., who stayed in Room 701 at \$13.00 per day, from October 11- 30, 1960. She said it was her recollection that MAHEU paid the bill for both these rooms. She advised that at the present the Kenilworth is undergoing an audit by an independent auditing firm, and long distance telephone records are not now available. She said she felt such records would be available in about one week. She also said it was possible that either ROLLINS or MAHEU could have left the hotel for a few days and returned, and if the room was not given up, such information would not be reflected on the registration card. She said she had no way of knowing if such a thing had occurred.

On 1/25/61 at Miami Beach, Florida File # Miami 139-63

by Special Agent [REDACTED] GK Date dictated 1/25/61

Full investigation under Unauthorized
Publication or Use of Communications Statute
being conducted on Balletti at Department's
request. Balletti and one J. W. Harrison reported-
ly tapped phone of Dan Rowan, comedian
romantically interested in Phyllis McGuire of
the McGuire Sisters Trio. Former Special Agent
DuBois on interview stated he furnished Balletti
for "surveillance work" and Robert Maheu (former
Special Agent) Associates furnished Harrison.
Maheu on interview denied furnishing anyone for the
job but was contacted by Los Angeles attorney who
he refused to identify and he recommended DuBois
for the job.

FBI

Date: 1/30/61

Transmit the following in AIRTEL
(Type in plain-text or code)

Via AIRMAIL
(Priority or Method of Mailing)

TO: DIRECTOR, FBI
FROM: SAC, MIAMI (139-63)
RE: ARTHUR JAMES BALLETTI;
UNKNOWN SUBJECT
UPUC
(OO: Salt Lake City)

war

ReBuairtel, 1/27/61.

b7c

Report of SA [redacted] at Miami, submitted, 1/28/61.

Info copy of this airtel being sent Salt Lake City.

- P
- ③ - Bureau (AM)
- 1 - Salt Lake City (139-17) (Info)
- 2 - Miami
- RKL: jgm
- (6)

EX-134

REC-44

1201-1

JAN 31 1961

62 FEB 8 1961

Special Agent in Charge

Sent _____ M Per _____

[Handwritten signature]

FBI

Date: 2/7/61

Transmit the following in PLAIN TEXT
(Type in plain text or code)

Via AIRTEL AIR MAIL
(Priority or Method of Mailing)

TO: DIRECTOR, FBI
FROM: SAC, SALT LAKE CITY (139-17)
RE: ARTHUR JAMES BALLETTI;
UNSUB, aka, J. W. Harrison
UPUC
(OO:SALT LAKE CITY)

Handwritten: 1
5-

b7c Re Washington Field airtel to Bureau dated 1/30/61 and report of S [redacted] dated 1/28/61 at Miami.

b7c THOMAS FOLEY, Attorney at Law, Las Vegas, Nevada, advised SA [redacted] on 2/6/61 that he received a call from JAMES P. CANTILLION, of the Law Firm of Cantillion & Cantillion, in Los Angeles, California. FOLEY stated call received after office hours at his residence, exact date not recalled, but in latter part of October, 1960.

In reply to FOLEY's question relative to payment of his legal fee, CANTILLION stated that he would personally guarantee the payment of FOLEY's fee. Call was for FOLEY to represent BALLETTI on the local charge at Las Vegas and to arrange for his bond.

FOLEY stated that he is not sure, but thinks JAMES P. CANTILLION is the son of the Father & Son partners in the Law Firm of Cantillion.

P.

- 3 - Bureau
- 2 - Los Angeles (139-77) (Enc. 1)
- 2 - Miami (139-63)
- 2 - Washington Field (139-61)
- 1 - Chicago (info)
- 2 - Salt Lake City

Stamp: REC-42 139-1201-11

10 FEB 9 1961

NBP:chl
(12)

Approved: *[Signature]*
Special Agent in Charge

Sent _____ M Per _____

SU 139-17

Los Angeles prior to interview of CANTILLION, review office indices on JAMES P. CANTILLION. Los Angeles interview CANTILLION and ascertain his interest in subject BALLETTI and why he called FOLEY to represent BALLETTI. Determine if CANTILLION was attorney who called ROBERT MAHEU in Washington, D. C. to furnish the two men for the job in Las Vegas of technical surveillance on DAN ROWAN. Attempt to ascertain identity of unsub J. W. HARRISON.

In event CANTILLION refuses to furnish the information, he should be firmly advised that there is a good possibility he will be subpoenaed to testify before the Federal Grand Jury at Las Vegas, relative to instant matter.

Washington Field note results of interview with EDWARD DUBOIS, JR., set forth in reports of SA [REDACTED] b7C [REDACTED] dated 12/23/60 and 1/28/61 at Miami reflect DUBOIS claims ROBERT MAHEU made second call to DUBOIS to send only one man to Las Vegas. Results of interview with MAHEU set forth in report of [REDACTED] b7C [REDACTED] Dated 1/12/61, reflects MAHEU denies making the second call to DUBOIS relative to the second man. Thus, it appears MAHEU Or DUBOIS being untruthful. Washington Field, in your reinterview with MAHEU, again ask MAHEU about the second call, attempt to ascertain if he in fact did make the call as claimed by DUBOIS.

Miami note DUBOIS made conflicting statement in two interviews relative to when and how he learned about arrest of BALLETTI at Las Vegas. DUBOIS during interview on 12/13/60 claimed only piece of equipment taken by BALLETTI to Las Vegas was a Minifon. Miami refer to report of SA [REDACTED] b7C [REDACTED] dated 12/30/60 at Salt Lake City, which set forth list of property in possession of BALLETTI at time of his arrest. Reinterview BALLETTI, obtain his admission or denial whether each item set out is his property. If he denies any item his property, ascertain to whom property belongs and disposition BALLETTI was to make of these items.

Enclosed to Los Angeles is copy of referenced airtel.

Bureau has instructed investigation must be thorough, complete and vigorously pursued. All offices expedite.

BLAYLOCK

FEDERAL BUREAU OF INVESTIGATION

Reporting Office SALT LAKE CITY	Office of Origin SALT LAKE CITY	Date 2/8/61	Investigative Period 1/2/61-2/6/61
TITLE OF CASE ARTHUR JAMES BALLETTI; UNKNOWN SUBJECT, aka. <u>J. W.</u> <u>Harrison</u>		Report made by [REDACTED] b7c	Type J1
		CHARACTER OF CASE UPUC	

XXXXX

REFERENCES: Report of SA [REDACTED] ^{b7c} dated 12/30/60, at Salt Lake City.
New York airtel to Bureau, dated 1/3/61.
Washington Field Office airtel to Bureau, dated 1/30/61.
Report of SA [REDACTED] ^{b7c} dated 1/28/61, at Miami.

- P -

LEADS

Copies for information furnished to Los Angeles, Miami, Washington Field, in view of investigation being conducted by those offices.

Copy furnished to Chicago for information since Chicago may be requested to conduct investigation in future.

Approved <i>[Signature]</i>	Special Agent In Charge	Do not write in spaces below		
Copies made: (2 - Bureau 1 - USA, Reno 1 - Chicago (Info) 1 - Washington Field (139-61) (Info) 1 - Miami (139-63) (Info) 1 - Los Angeles (139-77) (Info) 2 - Salt Lake City (139-17)		139-1201		REC-1
		7 FEB 18 1961		
		[Handwritten notes]		
		[Handwritten notes]		

Rec'd [unclear] 2/14/61 [unclear]

FEB 20 1961

SU 139-17

SALT LAKE CITY DIVISION

AT LAS VEGAS, NEVADA

Discuss matter with U. S. Attorney upon receipt of results of requested investigation.

UNITED STATES DEPARTMENT OF JUSTICE
FEDERAL BUREAU OF INVESTIGATION

Copy to: 1 - USA, Reno, Nevada

Report of: [REDACTED] b7C
Date: 2/8/61

Office: Salt Lake City, Utah

Field Office File No.: 139-17

Bureau File No.:

Title: ARTHUR JAMES BALLETTI;
UNKNOWN SUBJECT, aka.
J. W. HarrisonCharacter: UNAUTHORIZED PUBLICATION
AND USE OF COMMUNICATIONS

Synopsis: Efforts to identify unknown subject, aka., J. W. Harrison, unsuccessful. AUSA, Las Vegas, Nevada, stated will probably present matter to Federal Grand Jury at Las Vegas upon completion of investigation.

- P -

DETAILS:AT LAS VEGAS, NEVADA

Date January 3, 1961

b7c [REDACTED] PHYLLIS MC GUIRE was interviewed at Apartment [REDACTED] New York City. She advised that she had not given authority to anyone to install a listening device on DAN ROWAN at any time and had no prior knowledge that such a device had been in use prior to the arrest of ARTHUR JAMES BALLETTI.

On 1/2/61 at New York, New York File # 139-94

by SAS [REDACTED] [REDACTED] :jc Date dictated 1/3/61

Date 1/25/61

b7C

[REDACTED] TransWorld Airlines, Las Vegas, Nevada, whose name was listed as person who sold ticket to individual using name J. W. HARRISON on or about October 29, 1960, was contacted on January 18, 1961. The person who purchased ticket using name HARRISON departed Las Vegas, Nevada, on October 30, 1960, via TransWorld Airlines Flight 292 at 10:30 AM to St. Louis, Missouri, where he connected with TransWorld Airlines Flight 76 to Miami, Florida.

b7C Nine photographs, including photo of FRED T. HARRIS, were exhibited to [REDACTED] who advised he could not recall having observed any of the individuals before.

b7C [REDACTED] stated he could not recall the individual who purchased ticket for above described flight.

On 1/18/61 at Las Vegas, Nevada File # Salt Lake City 139-17
by SA [REDACTED] /jl Date dictated 1/19/61

This document contains neither recommendations nor conclusions of the FBI. It is the property of the FBI and is loaned to your agency; it and its contents are not to be distributed outside your agency.

SU 139-17

Assistant U. S. Attorney RAYMOND E. SUTTON, Las Vegas, advised on January 16, 1961, that in view of refusal of ROBERT MAHEU to furnish name of attorney who had contacted him to furnish a private detective, he was considering possibility of issuing subpoena for MAHEU to testify before Federal Grand Jury since in all probability entire matter would be presented to Federal Grand Jury at Las Vegas.

By communication dated January 30, 1961, the Washington Field Office advised that ROBERT MAHEU on January 30, 1961, telephonically contacted the Washington Field Office and advised that he had been in touch with the attorney in Los Angeles, California, but the attorney did not desire to have his name furnished to the FBI. He stated he was going to Los Angeles on January 31, 1961, where he would talk further with the attorney and attempt to secure his permission to furnish the name of the attorney.

Date 2/8/61

THOMAS FOLEY, Attorney at Law, advised as follows:

During the latter part of October, 1960, exact date not recalled, he received a telephone call from JAMES P. CANTILLION, an attorney in Los Angeles, California, requesting FOLEY to represent one ARTHUR J. BALLETTI, who had been arrested by the Clark County Sheriff's Office. FOLEY said he received the call after office hours at his home. He asked CANTILLION about payment of the legal fee, and CANTILLION stated he would personally guarantee payment of the fee.

FOLEY said that he immediately contacted a bail bondsman and arranged bond for BALLETTI.

FOLEY said that he is of the opinion but is not sure that JAMES P. CANTILLION is the son of father and son team of Cantillion and Cantillion, a law firm in Los Angeles, California.

FOLEY said that trial for BALLETTI on the local charge is set for April, 1961, in Las Vegas.

On 2/6/61 at Las Vegas, Nevada File # Salt Lake City 139-17
 by SA [REDACTED] 31 Date dictated 2/6/61

This document contains neither recommendations nor conclusions of the FBI. It is the property of the FBI and is loaned to your agency; it and its contents are not to be distributed outside your agency.

FBI

Date: 2/13/61

Transmit the following in _____
(Type in plain text or code)

Via AIRTEL _____
(Priority or Method of Mailing)

Mr. Tolson	_____
Mr. Boardman	_____
Mr. Nichols	_____
Mr. Belmont	_____
Mr. Mohr	_____
Mr. DeLoach	_____
Mr. Casper	_____
Mr. Callahan	_____
Mr. Conrad	_____
Mr. Felt	_____
Mr. Gale	_____
Mr. Rosen	_____
Mr. Sullivan	_____
Mr. Tavel	_____
Mr. Trotter	_____
Mr. Tele. Room	_____
Mr. Ingram	_____
Miss Gandy	_____

TO: DIRECTOR, FBI
FROM: SAC, WFO (139-61)

Handwritten signatures and initials

ARTHUR JAMES BALLETTI;
UNSUB, aka
J. W. Harrison
UPUC
(OO:SU)

ReWFOairtel 1/30/61 and SUairtel 2/7/61.

On 2/8/61, ROBERT MAHEU, Maheu & King Associates, Inc., 1125-19th St., N.W., advised that he had just returned from California but after talking to the Los Angeles attorney who had originally requested him to contact EDWARD DUBOIS, had been unable to secure permission from this attorney to divulge his name to the FBI. The Los Angeles attorney had advised MAHEU that he did not desire to become involved in this matter.

On this same date MAHEU stated that it is now his recollection that WALTER FITZPATRICK, an associate of MAHEU's, had contacted DUBOIS regarding the request of the Los Angeles attorney to secure someone to do some investigating work for him. MAHEU emphatically denied that he or FITZPATRICK had contacted DUBOIS requesting DUBOIS to send only one man to Las Vegas and instructing DUBOIS that he, MAHEU, would furnish the second man.

- 3-Bureau
- 2-Los Angeles (139-77)
- 2-Miami (139-63)
- 2-Salt Lake City (139-17)
- 1-Chicago (Info)
- 1-WFO

REC-16
EX-114

139-1201-11

15 FEB 15 1961

CWB:eap
(11)

AIRTEL

U. C. Wick

Approved: 51 FEB 20 1961
Special Agent in Charge

Sent _____ M Per _____

MAHEU stated that he stayed at the Kenilworth Hotel in Miami Beach, Florida, during the latter part of October, 1960. He recalled that he contacted DUBOIS while in Miami Beach but denied that he had told DUBOIS that he was staying at the Kenilworth Hotel nor on this occasion did he instruct DUBOIS to send only one man to Las Vegas. MAHEU again stated that his only involvement in instant matter was to have DUBOIS contacted at the request of the Los Angeles attorney. He denied that he had instructed DUBOIS as to how to handle the matter and denies emphatically that he supplied any employee to assist on this investigation. MAHEU stated that he did receive \$1,000 from the Los Angeles attorney which he immediately turned over to DUBOIS. He stated that he made no money in connection with this matter and never changed the original arrangements made with DUBOIS.

MAHEU identified J. A. ROLLINS, who was with MAHEU at the Kenilworth Hotel as JOHN A. ROLLINS. MAHEU would not identify ROLLINS further as to ROLLINS' being an employee of Maheu, stating that ROLLINS was working indirectly for Maheu in Miami. MAHEU denied that ROLLINS was the individual who went to Las Vegas to assist BALLETTI, stating that the Kenilworth Hotel records would reflect that ROLLINS was in Miami Beach during the period that BALLETTI was in Las Vegas.

b7C
||
MAHEU, after the above interview, telephonically contacted WFO, advising SA [REDACTED] that he "had just received a phone call and if this matter could be held up for a few days it would be straightened out." MAHEU was asked if he would again contact WFO to which he advised that the matter would be handled through other channels.

The Washington Metropolitan Area Telephone Directory for 1960-61, Polk's Washington City Directory, 1960, records of the Credit Bureau and WFO indices fail to reflect or identify JOHN A. ROLLINS. It is noted that the address of 1125-19th St., N.W., reflected as the address of ROLLINS at the Kenilworth Hotel is the office of MAHEU in Washington, D.C. Report to follow.

FEDERAL BUREAU OF INVESTIGATION

REPORTING OFFICE MIAMI	OFFICE OF ORIGIN SALT LAKE CITY	DATE 2/14/61	INVESTIGATIVE PERIOD 2/3/61
TITLE OF CASE ARTHUR JAMES BALLETTI; UNKNOWN SUBJECT, aka, J. W. Harrison		REPORT MADE BY [REDACTED] <i>b7C</i>	TYPED BY RKL jlt
		CHARACTER OF CASE UPUC	

REFERENCES: Report of SA [REDACTED] dated 1/28/61, at Miami.
Washington Field airtel to Bureau, 1/30/61.

**ALL INFORMATION CONTAINED
HEREIN IS UNCLASSIFIED**

- P -

DATE 3/6/81 BY [Signature] - LEADS -

Comp. # 22330

Leads at this time are being limited to phone calls made by MAREU and ROLLINS, to areas which appear pertinent in this investigation, namely, Washington, D. C., Los Angeles, Las Vegas, and Miami. All Offices note that in some cases the letter prefixes for the phone numbers listed were almost illegible, and there may be some inaccuracy in these prefixes.

67C
 5
 1
 2
 3
 4
 5
 6
 7
 8
 9
 10
 11
 12
 13
 14
 15
 16
 17
 18
 19
 20
 21
 22
 23
 24
 25
 26
 27
 28
 29
 30
 31
 32
 33
 34
 35
 36
 37
 38
 39
 40
 41
 42
 43
 44
 45
 46
 47
 48
 49
 50
 51
 52
 53
 54
 55
 56
 57
 58
 59
 60
 61
 62
 63
 64
 65
 66
 67
 68
 69
 70
 71
 72
 73
 74
 75
 76
 77
 78
 79
 80
 81
 82
 83
 84
 85
 86
 87
 88
 89
 90
 91
 92
 93
 94
 95
 96
 97
 98
 99
 100
 101
 102
 103
 104
 105
 106
 107
 108
 109
 110
 111
 112
 113
 114
 115
 116
 117
 118
 119
 120
 121
 122
 123
 124
 125
 126
 127
 128
 129
 130
 131
 132
 133
 134
 135
 136
 137
 138
 139
 140
 141
 142
 143
 144
 145
 146
 147
 148
 149
 150
 151
 152
 153
 154
 155
 156
 157
 158
 159
 160
 161
 162
 163
 164
 165
 166
 167
 168
 169
 170
 171
 172
 173
 174
 175
 176
 177
 178
 179
 180
 181
 182
 183
 184
 185
 186
 187
 188
 189
 190
 191
 192
 193
 194
 195
 196
 197
 198
 199
 200
 201
 202
 203
 204
 205
 206
 207
 208
 209
 210
 211
 212
 213
 214
 215
 216
 217
 218
 219
 220
 221
 222
 223
 224
 225
 226
 227
 228
 229
 230
 231
 232
 233
 234
 235
 236
 237
 238
 239
 240
 241
 242
 243
 244
 245
 246
 247
 248
 249
 250
 251
 252
 253
 254
 255
 256
 257
 258
 259
 260
 261
 262
 263
 264
 265
 266
 267
 268
 269
 270
 271
 272
 273
 274
 275
 276
 277
 278
 279
 280
 281
 282
 283
 284
 285
 286
 287
 288
 289
 290
 291
 292
 293
 294
 295
 296
 297
 298
 299
 300
 301
 302
 303
 304
 305
 306
 307
 308
 309
 310
 311
 312
 313
 314
 315
 316
 317
 318
 319
 320
 321
 322
 323
 324
 325
 326
 327
 328
 329
 330
 331
 332
 333
 334
 335
 336
 337
 338
 339
 340
 341
 342
 343
 344
 345
 346
 347
 348
 349
 350
 351
 352
 353
 354
 355
 356
 357
 358
 359
 360
 361
 362
 363
 364
 365
 366
 367
 368
 369
 370
 371
 372
 373
 374
 375
 376
 377
 378
 379
 380
 381
 382
 383
 384
 385
 386
 387
 388
 389
 390
 391
 392
 393
 394
 395
 396
 397
 398
 399
 400
 401
 402
 403
 404
 405
 406
 407
 408
 409
 410
 411
 412
 413
 414
 415
 416
 417
 418
 419
 420
 421
 422
 423
 424
 425
 426
 427
 428
 429
 430
 431
 432
 433
 434
 435
 436
 437
 438
 439
 440
 441
 442
 443
 444
 445
 446
 447
 448
 449
 450
 451
 452
 453
 454
 455
 456
 457
 458
 459
 460
 461
 462
 463
 464
 465
 466
 467
 468
 469
 470
 471
 472
 473
 474
 475
 476
 477
 478
 479
 480
 481
 482
 483
 484
 485
 486
 487
 488
 489
 490
 491
 492
 493
 494
 495
 496
 497
 498
 499
 500
 501
 502
 503
 504
 505
 506
 507
 508
 509
 510
 511
 512
 513
 514
 515
 516
 517
 518
 519
 520
 521
 522
 523
 524
 525
 526
 527
 528
 529
 530
 531
 532
 533
 534
 535
 536
 537
 538
 539
 540
 541
 542
 543
 544
 545
 546
 547
 548
 549
 550
 551
 552
 553
 554
 555
 556
 557
 558
 559
 560
 561
 562
 563
 564
 565
 566
 567
 568
 569
 570
 571
 572
 573
 574
 575
 576
 577
 578
 579
 580
 581
 582
 583
 584
 585
 586
 587
 588
 589
 590
 591
 592
 593
 594
 595
 596
 597
 598
 599
 600
 601
 602
 603
 604
 605
 606
 607
 608
 609
 610
 611
 612
 613
 614
 615
 616
 617
 618
 619
 620
 621
 622
 623
 624
 625
 626
 627
 628
 629
 630
 631
 632
 633
 634
 635
 636
 637
 638
 639
 640
 641
 642
 643
 644
 645
 646
 647
 648
 649
 650
 651
 652
 653
 654
 655
 656
 657
 658
 659
 660
 661
 662
 663
 664
 665
 666
 667
 668
 669
 670
 671
 672
 673
 674
 675
 676
 677
 678
 679
 680
 681
 682
 683
 684
 685
 686
 687
 688
 689
 690
 691
 692
 693
 694
 695
 696
 697
 698
 699
 700
 701
 702
 703
 704
 705
 706
 707
 708
 709
 710
 711
 712
 713
 714
 715
 716
 717
 718
 719
 720
 721
 722
 723
 724
 725
 726
 727
 728
 729
 730
 731
 732
 733
 734
 735
 736
 737
 738
 739
 740
 741
 742
 743
 744
 745
 746
 747
 748
 749
 750
 751
 752
 753
 754
 755
 756
 757
 758
 759
 760
 761
 762
 763
 764
 765
 766
 767
 768
 769
 770
 771
 772
 773
 774
 775
 776
 777
 778
 779
 780
 781
 782
 783
 784
 785
 786
 787
 788
 789
 790
 791
 792
 793
 794
 795
 796
 797
 798
 799
 800
 801
 802
 803
 804
 805
 806
 807
 808
 809
 810
 811
 812
 813
 814
 815
 816
 817
 818
 819
 820
 821
 822
 823
 824
 825
 826
 827
 828
 829
 830
 831
 832
 833
 834
 835
 836
 837
 838
 839
 840
 841
 842
 843
 844
 845
 846
 847
 848
 849
 850
 851
 852
 853
 854
 855
 856
 857
 858
 859
 860
 861
 862
 863
 864
 865
 866
 867
 868
 869
 870
 871
 872
 873
 874
 875
 876
 877
 878
 879
 880
 881
 882
 883
 884
 885
 886
 887
 888
 889
 890
 891
 892
 893
 894
 895
 896
 897
 898
 899
 900
 901
 902
 903
 904
 905
 906
 907
 908
 909
 910
 911
 912
 913
 914
 915
 916
 917
 918
 919
 920
 921
 922
 923
 924
 925
 926
 927
 928
 929
 930
 931
 932
 933
 934
 935
 936
 937
 938
 939
 940
 941
 942
 943
 944
 945
 946
 947
 948
 949
 950
 951
 952
 953
 954
 955
 956
 957
 958
 959
 960
 961
 962
 963
 964
 965
 966
 967
 968
 969
 970
 971
 972
 973
 974
 975
 976
 977
 978
 979
 980
 981
 982
 983
 984
 985
 986
 987
 988
 989
 990
 991
 992
 993
 994
 995
 996
 997
 998
 999
 1000

APPROVED <i>[Signature]</i>	SPECIAL AGENT IN CHARGE	DO NOT WRITE IN SPACES BELOW	
COPIES MADE: 2-Bureau (139-1201) 3-Salt Lake City (139-17) (1 - USA, Las Vegas) 2-Los Angeles 2-Washington Field (139-61) 2-Miami (139-63)		139-1501-20	REC-5
		FEB 15 1961	EX-104
Dissemination Record of Attached Report		Notations <i>[Handwritten notes]</i>	
Agency			
Request Recd.			
Date Fwd.			
How Fwd.			
By			

51 FEB 23 1961

MM 139-63

LCS ANGELES:

AT LOS ANGELES, BEVERLY HILLS AND PASADENA,
CALIFORNIA

Determine subscribers to phones called in those areas and determine background of subscribers through available sources. Interviews should be conducted where available information indicates that the subscriber might possibly be involved in this investigation, noting that efforts are being made to identify the attorney who allegedly hired NAFU and also to identify an individual known as J. W. HARRISON.

SALT LAKE CITY:

AT LAS VEGAS, NEVADA

1. Conduct similar investigation as to telephone DU 2-6000.
2. Will report results of display of photograph of ERUD T. HARRIS at Riviera Hotel. The photograph of HARRIS was forwarded to Salt Lake City, December 16, 1960.
3. Will report results of interviews at Riviera Hotel and furnish interested Offices with description of individual using name J. W. HARRISON.

WASHINGTON FIELD:

AT WASHINGTON, D. C.

Will conduct similar investigation as to phone numbers listed in Washington, D. C.

B.

- COVER PAGE -

MM 139-63

MIAMI:

AT FT. LAUDERDALE AND HOLLYWOOD, FLORIDA

Will conduct similar investigation as to phone numbers called in those two cities.

C*

- COVER PAGE -

UNITED STATES DEPARTMENT OF JUSTICE
FEDERAL BUREAU OF INVESTIGATION

Copy to: 1 - USA, Las Vegas

Report of: [REDACTED] b7C Office: Miami, Florida
Date: February 14, 1961

Field Office File #: 139-63 Bureau File #: 139-1201

Title: ARTHUR JAMES BALLETTI;
UNKNOWN SUBJECT, also known
as J. W. Harrison

Character: UNAUTHORIZED PUBLICATION AND USE OF
COMMUNICATIONS

Synopsis:

Long distance phone calls of ROBERT A. MAHEU and J. A. ROLLINS in Oct., 1960, from Kenilwerth Hotel, Miami Beach, set out.

- P -

DETAILS: AT MIAMI BEACH, FLORIDA

Date February 13, 1961

Records of the Kenilworth Hotel, 10205 Collins Avenue, Miami Beach, Florida, reflect that ROBERT A. MAHEU, 1125 19th Street, Northwest, Washington, D. C., was registered in Room 722 from October 11 - 29, 1960.

Hotel records reflect the following long distance calls by MAHEU:

<u>Date</u>	<u>City</u>	<u>Phone Numbers</u>
October 11, 1960	Washington, D.C.	JE 3-7277
October 12, 1960	"	FE 8-8500 (3)
	"	EX 3-6115
	"	JA 3-1441
	"	MU 6-6000
	Los Angeles, California	FE 1-0711
October 13, 1960	"	GR 5-5121
	Tucson, Arizona	EA 5-4172
	Washington, D.C.	FE 8-8500
October 14, 1960	"	JE 3-7277
	Los Angeles, California	TO 1-0311
October 16, 1960	Washington, D.C.	JE 3-7277
	Tucson, Arizona	EA 5-4172
	San Francisco, California	VI 2-1845
	Washington, D.C.	CL 6-1891

-2-

On 2/3/61 at Miami Beach, Florida File # Miami 139
 by Special Agent [REDACTED] jlt Date dictated 2/7/61

MM 139-63

<u>Date</u>	<u>City</u>	<u>Phone Numbers</u>
October 20, 1960	Los Angeles California	OL 4-2556 (2)
	"	TO 1-0311
	Washington, D.C.	JE 3-7277
	"	FE 8-8500 (2)
	"	EX 3-4900
October 21, 1960	New York	PL 5-0436
	Washington, D.C.	LO 6-9660
	"	FE 8-8500
	Los Angeles	CL 4-2556
	"	MA 6-5133
October 22, 1960	Ft. Lauderdale, Florida	JA 3-1441
	Washington, D.C.	JE 3-7277
	Ft. Lauderdale, Florida	LO 4-8511
	Hollywood, Florida	WA 2-7171
	Los Angeles	BI 2-7061
	"	SY 0-1273
	St. Louis, Missouri	FO 1-2500
October 23, 1960	"	FO 1-2500
	Hollywood, Florida	WA 2-7171
October 24, 1960	Washington, D.C.	JE 3-7277 (2)
	"	FE 8-8500
	St. Louis, Missouri	FO 1-2500
	Beverly Hills, California	CR 5-5121
	St. Louis, Missouri	JA 3-1441
	Los Angeles	BI 2-7061

MM 139-63

<u>Date</u>	<u>City</u>	<u>Phone Numbers</u>
October 25, 1960	Washington, D.C.	JE 3-7277
	"	YE 8-8500
	Los Angeles	CX 1-7552
	"	LO 4-2505
	Venice, Florida	23405 (2)
October 26, 1960	Washington, D.C.	OL 4-4284
October 27, 1960	Los Angeles	MA 9-2451
	Washington, D.C.	JE 3-7277 (2)
	"	FE 8-8500
	"	EX 3-4900
	St. Louis	JA 3-1441
	New York	CO 5-3320
	Los Angeles	LA 6-9511
Hollywood, Florida	WA 2-7171	
October 28, 1960	New York	FL 5-0436
	"	MU 6-1991
	Washington, D.C.	FE 8-8500
	"	JE 3-7277
	"	ME 8-6565
	Beverly Hills, California	CL 6-2251
	"	CR 5-5121
	Pasadena, Calif.	SY 0-1273
	Ft. Lauderdale, Florida	JA 3-1441
	Los Angeles	OL 4-2556
October 29, 1960	Washington, D.C.	JE 3-7277

- 4 -

MM 139-63

In the event the above telephone records are
-necessary, a subpoena should be directed to Miss EUDORA
HENDRICKS, Auditor, Kenilworth Hotel, 10205 Collins
Avenue, Miami Beach, Florida.

Date February 13, 1961

Records of the Kenilworth Hotel, 10205 Collins Avenue, Miami Beach, Florida, reflect that J. A. ROLLINS, 1125 19th Street, Northwest, Washington, D. C., was registered in Room 701 from October 11 - 30, 1960.

Hotel records reflect the following long distance phone calls by ROLLINS during the above period:

<u>Date</u>	<u>City</u>	<u>Phone Numbers</u>
October 13, 1960	Chicago	WH 3-1155
October 17, 1960	Las Vegas, Nevada	DU 2-6000
October 27, 1960	Los Angeles	DI 7-6298
October 28, 1960	Chicago	WH 3-1155

In the event the above telephone records are necessary, a subpoena should be directed to Miss EUDORA HENDRICKS, Auditor, Kenilworth Hotel, 10205 Collins Avenue, Miami Beach, Florida.

On 2/3/61 at Miami Beach, Florida File # Miami 139
 by Special Agent [REDACTED] :jlt ^{b7C} Date dictated 2/7/61

OFFICE MEMORANDUM - UNITED STATES GOVERNMENT

To: Director, FBI

Date: 2/18/61

From: SAC, Salt Lake City (139-17)

Subject: ARTHUR JAMES BALLETTI;
UNSUB, aka., J. W. Harrison
UPUC

31
75

Bufile # _____

Due to the opening of the Las Vegas Office, the following changes in the above case have been made:

A. Location of File

- (XX) Entire file sent to Las Vegas herewith.
- () File sent to Las Vegas, except one copy of the following serials.
- () File retained in Salt Lake City but one copy of following serials sent to Las Vegas.

Report of SA _____
Dated _____ at _____

Report of SA _____
Dated _____ at _____

Report of SA _____
Dated _____ at _____

Report of SA _____
Dated _____ at _____

B. Office of Origin

- () Salt Lake City
- (X) Las Vegas
- () Other Office as shown in file

C. Status, SU Office

- () Pending
- (X) RUC

- 1 - Bureau
- 1 - Las Vegas (Encl. 5 1) (139-1)
- 1 - Salt Lake City (66-1671)
- 1 - Chicago
- 1 - WFO (139-61)
- 1 - Miami (139-63)

- 1 - Los Angeles (139-77)
- 1 - New York (139-94)

137 -
NOT RECORDED
17 FEB 21 1961

57W
(6) FEB 27 1961

[Handwritten signatures and initials]

2-27-61

Airtel

To: SAC, Los Angeles
From: Director, FBI
ARTHUR JAMES BALLETTI
UPUC
OO: LAS VEGAS

en 1-

ReSUairtel 2-7-61.

LA advise results of contact with Cantillion. If report already submitted advise date and name of reporting agent.

This matter must be vigorously pursued and completed promptly.

1 - Las Vegas (info)

EJM:vjh
(5)

R

EX-107

MAILED 31
FEB 27 1961
COMM-FBI

REC-12

139-1201-21

- Tolson _____
- DeLoach _____
- Mohr _____
- Bishop _____
- Casper _____
- Callahan _____
- Conrad _____
- Felt _____
- Gale _____
- Rosen _____
- Sullivan _____
- Tavel _____
- Trotter _____
- Tele. Room _____
- Holmes _____
- Gandy _____

19 FEB 28 1961

50 MAR 2, 1961 TELETYPE UNIT

FBI

Date: 3/1/61

Transmit the following in _____
(Type in plain text or code)

Via AIRTEL AIR MAIL
(Priority or Method of Mailing)

TO: DIRECTOR, FBI
FROM: SAC, LOS ANGELES (139-77)
RE: ARTHUR JAMES BALLETTI
UPUC
OO: Las Vegas

ph
1

ReBuairtel 2/27/61 and Salt Lake City airtel 2/7/61.

b7C

JAMES P. CANTILLON, Suite 438, 9441 Wilshire Blvd. Beverly Hills, California, interviewed today by SAs [redacted] and [redacted]. He is in partnership with his father and brother in what appears to be an affluent practice. JAMES CANTILLON has represented [redacted]

b7C
OS

[Large redacted block]

CANTILLON said his first knowledge of this matter came with a phone call to him from a man in custody at Las Vegas. He claimed inability to recall the man's name and said he had never before heard of him. Given the name ARTHUR JAMES BALLETTI, CANTILLON acknowledged that that was probably correct, but he advised he had no knowledge of BALLETTI prior to the call which came, he said, from the office of a Lieutenant in either the Clark County SO or

Handwritten initials/signature

- 3 - Bureau
- 2 - Las Vegas
- 2 - Los Angeles (1 - 62- ROBERT MAHUE ASSOCIATES)

FHT:djv
(7)

REC-75 139-1201-2

MAR 8 1961

Approved: _____ Sent _____ M Per _____
Special Agent in Charge

CC - [redacted]

LA 139-77

at the Las Vegas City Jail. He declined to relate any of the conversation with BALLETTI claiming privilege. He did say he referred the caller to Attorney TOM FOLEY in Las Vegas and that he then phoned FOLEY about the matter. He believes he talked to FOLEY regarding this a week later in person at Las Vegas while there on unrelated business.

CANTILLON volunteered that he had thought the case against BALLETTI involved simply a microphone installation rather than a telephone tap. He said he never did learn the disposition of the case but did hear from FOLEY that charges had been reduced and that authorities in Las Vegas had kept BALLETTI's equipment. He maintained he does not know DAN ROWAN. When first called from Las Vegas he thought BALLETTI was referring to another ROWAN, one of the casino owners in Las Vegas and the thought struck him "Boy he must have some juicy tapes."

CANTILLON said he knows ROBERT MAHUE and he admittedly sees MAHUE in Beverly Hills. He denied phoning or otherwise contacting MAHUE in Washington, D.C. or elsewhere to ask for men to perform surveillance of DAN ROWAN or for any other purpose having to do with this matter. He denied knowing any person named J. W. HARRISON.

When advised that there is a good chance he will be subpoenaed before the FGJ in Las Vegas relative to this matter, CANTILLON said that that would be all right that he is frequently in Las Vegas on certain legal business having to do with settlement of the Stardust Hotel suit. He guessed the FGJ would be in session during March which he said would not be inconvenient to him.

b7c Report by SA [REDACTED] incorporating above to follow.

FBI

Date: 2/28/61

Transmit the following in _____
(Type in plain text or code)

Via AIRTEL AIR MAIL
(Priority or Method of Mailing)

TO DIRECTOR, FBI
FROM: SAC, LOS ANGELES (139-77)
RE: ARTHUR JAMES BALLETTI
UPUC
OO: Las Vegas

ReBuairtel 2/27/61.

Daily efforts unsuccessful to complete desired interview with JAMES P. CANTILLON, Beverly Hills Attorney who has represented various hoodlum figures. Efforts continuing.

Bureau and Las Vegas will be promptly advised of results.

- (3) - Bureau
- 1 - Las Vegas
- 1 - Los Angeles

FHT:djv
(5)

*Airtel to LA
3-3-61 ESM/ajh*

REC-101

139-1507-23

10 FEB 28 1961

Approved: _____
Special Agent in Charge

Sent _____
M Per

C C - AMW

3-3-61

Airtel

REC-101

137-1201-23

To: SAC, Los Angeles

From: Director, FBI

ARTHUR JAMES BALLETTI
UPUC
OO:LAS VEGAS

11

Reurairtel 2-28-61.

Submit background information on Cantillion in
letterhead memorandum suitable for dissemination immediately.

EJM:vjh
(4)

vjh

REC/211c

MAILED 20
MAR 3 - 1961
COMM-FBI

- Tolson _____
- Mohr _____
- Parsons _____
- Belmont _____
- Casper _____
- Conrad _____
- DeLoach _____
- Malone _____
- McGuire _____
- Rosen _____
- Trotter _____
- Evans _____
- W. C. Sullivan _____
- Tele. Rm. _____
- Ingram _____
- Gandy _____

52 MAR 8 1961

7 27
RJK

SM

MAIL ROOM TELETYPE UNIT

F B I

Date: 3/1/61

Transmit the following in _____

PLAIN TEXT

(Type in plain text or code)

Via _____

AIRTEL

AIRMAIL

(Priority or Method of Mailing)

TO: DIRECTOR, FBI

FROM: SAC, LAS VEGAS (139-1)

RE: ARTHUR JAMES BALLETTI;
UNSUB; aka. J. W. Harrison
UPUC
OO:Las Vegas

b7c Rerep of SA [redacted] dated 2/8/61, at Salt Lake City; report of SA [redacted] dated 1/28/61, at Miami; Salt Lake City airtel dated 2/7/61, and Washington Field Office airtel to the Bureau dated 2/13/61, and report *b7c* of SA [redacted] dated 2/14/61, at Miami.

In view of information set forth in referenced Washington Field Office airtel dated 2/13/61, Washington Field Office, if not already done, interview WALTER FITZPATRICK, since ROBERT MAHEU claims FITZPATRICK was person who actually contacted EDWARD DUBOIS in Miami, relative to sending someone to Las Vegas for investigative work.

Miami, conduct credit and criminal on JOHN A. ROLLINS and attempt to identify, since MAHEU refuses to further identify him. At Kenilworth Hotel, determine if both MAHEU and ROLLINS signed registration card. If ROLLINS signed registration card, secure same and forward to FBI Laboratory for comparison with handwriting on Hotel registration card signed by person who registered

P

- 3 - Bureau
- 2 - Los Angeles (139- 77)
- 2 - Miami (139-63)
- 2 - Washington Field Office (139-61)
- 2 - Chicago (Info.)
- 2 - Las Vegas (139-1)

REC-101 139-1011-24
MAR 5 1961
MCDONALD
SBA

MAR 8 1961
(13)

Approved: _____

Special Agent in Charge

Sent _____

M

Per _____

SU (139-1)

at Riviera Hotel, Las Vegas, using name J. W. HARRISON. Immediately advise Las Vegas if registration card obtained, in order that card can be secured for Riviera Hotel and forwarded to Laboratory by Las Vegas.

b7C For the information of Chicago, referenced report of SA [REDACTED] dated 2/14/61 at Miami reflects J. A. ROLLINS, who registered at Kenilworth Hotel, Miami Beach, Florida from 10/11-30/60 made telephone call on 10/13/60 and 10/28/60 to Chicago WH 3-1155; on 10/17/60, to Las Vegas, Nevada DU 2-6000 (This is Desert Inn Hotel in Las Vegas), and on 10/27/60, to Los Angeles, California, DI 7-6298. Chicago, identify subscriber of WH 3-1155. Los Angeles, identify subscriber of 4 DI 7-6298.

b7C Miami, refer to Salt Lake City airtel of 2/7/61; expedite coverage of leads set forth for Miami. Miami, refer to report of SA [REDACTED] dated 2/8/61, at Salt Lake City, which set forth results of display of photograph of FRED T. HARRIS at Riviera Hotel. Report of SA [REDACTED] dated 12/30/60, sets forth results of interviews at Riviera Hotel of persons who had any knowledge of instant matter. Only description available at Las Vegas of unknown subject, also known as J. W. Harrison, is set forth in Miami communication dated 12/13/60. No one could be located at Riviera Hotel, who could recall description of unknown subject.

All offices expedite investigation and submit report. Bureau has instructed investigation must be thorough, complete, and vigorously pursued.

WILLIAMS

FEDERAL BUREAU OF INVESTIGATION

Reporting Office LOS ANGELES	Office of Origin LAS VEGAS	Date 3/6/61	Investigative Period 2/3 - 3/1/61
TITLE OF CASE ARTHUR JAMES BALLETTI; UNSUB, aka. J. W. Harrison		Report made by [REDACTED] b7C	Typed By sgt
		CHARACTER OF CASE UPUC	

~~513636X~~

REFERENCES:

b7C {
 Report SA [REDACTED] at Miami, 1/28/61.
 Report SA [REDACTED] at Salt Lake City 2/8/61.
 WFO Airtel to the Bureau 1/30/61.
 Salt Lake City airtel to Bureau 2/7/61.
 Report SA [REDACTED] at Miami 2/14/61.
 WFO Airtel to the Bureau 2/13/61.
 Salt Lake City letter to the Bureau and
 Los Angeles 2/18/61.
 Bureau airtel to Los Angeles 2/27/61.
 Las Vegas airtel to the Bureau and Los Angeles 3/1/61.
 Los Angeles airtel to the Bureau and Los Vegas 3/1/61.

- P -

ADMINISTRATIVE

INFORMANTS REGARDING LISTING OF TELEPHONE NUMBERS

Handwritten notes and signatures on the right side of the page.

Approved <i>[Signature]</i>	Special Agent in Charge	Do not write in spaces below	
Copies made: 2 - Bureau (139-1201) 3 - Las Vegas (139-1) 3 - Los Angeles (139-77) (1 - 62-ROBERT MAHEU ASSOCIATES)		139-1201-120	REG-6
		25 MAR -9 1961	EX-114

1cc: AAG Criminal Division
Form 6-21 (A) *[Signature]*

57 MAR 23 1961

Handwritten signatures and notes at the bottom of the page.

LA 139-77

OS b2
b7D

[REDACTED]

[REDACTED] b7C

OS b2
b7D

[REDACTED]

[REDACTED] b7C

JAMES P. CANTILLON, Suite 438, 9441 Wilshire Boulevard, Beverly Hills, California, interviewed on 3/1/61 by SAs [REDACTED] and [REDACTED] advised he is in partnership with his father and brother, in what appears to be an affluent practice. JAMES CANTILLON has represented [REDACTED]

b7C

b7C
OS

[REDACTED]

When advised that there is a good chance he will be subpoenaed before the FGJ in Las Vegas relative to this matter, CANTILLON said that that would be all right that he is frequently in Las Vegas on certain legal business having to do with settlement of the Stardust Hotel suit. He guessed the FGJ would be in session during March which he said would not be inconvenient to him.

OS b2
b7C
b7D

On [REDACTED] advised SA [REDACTED] that JAMES L. ARDITTO, Attorney, was a former legal counsel for HOWARD HUGHES. Further, that ARDITTO now has pending a suit against HUGHES in the amount of about \$1,200,000.00 for payment of legal services rendered.

b7C

b7C
OS

In regard to [REDACTED] Attorney, [REDACTED] His reputation is doubtful.

b7C

Attention is called to the Office of Origin, Las Vegas, of the report of SA [REDACTED] at Miami dated 2/14/61, page 4, which set out telephone numbers of MA 9-2451 and LA 6-9511. This is to advise that these numbers and prefixes appear to be incorrect. The telephone number Madison 6-9511 is the public listing for the Los Angeles County Sheriff's Office in Los Angeles, California.

- B -

COVER PAGE

IA 139-77

LEADS

LOS ANGELES

AT LOS ANGELES, CALIFORNIA. 1. Will interview JAMES L. ARDITTO, Attorney, 727 West Seventh Street, which is his business address and telephone number MADISON 3-3624. Will determine if ARDITTO is involved in instant case, if so, to what extent and he should be reminded of possible subpoena to the FGJ in Las Vegas, Nevada, if he is involved in instant case.

2. Will interview GREGSON BAUTZER, Attorney, and ARNOLD M. GRANT, Attorney, both having business address at 190 North Cannon Drive, Beverly Hills, California, telephone CRestview 5-5121. These interviews are for the same purpose as the interview of JAMES L. ARDITTO, Attorney, as set out above.

AT WOODLAND HILLS, CALIFORNIA. Will consider, after determining background information, interview of [REDACTED] to determine if he has any connection in instant case, the purpose of the interview being the same as set out for interview of Attorney JAMES L. ARDITTO.

AT WHITTIER, CALIFORNIA. Will also consider, after determining background information, interview of [REDACTED] to determine if he has any connection with instant case.

UNITED STATES DEPARTMENT OF JUSTICE
FEDERAL BUREAU OF INVESTIGATION

Copy to:

Report of:

b7C

Date:

[REDACTED] /sgt
3/6/61

Office: Los Angeles, California

Field Office File No.:

139-77

Bureau File No.:

139-1201

Title:

ARTHUR JAMES BALLETTI;
UNSUB

Character:

UNAUTHORIZED PUBLICATION AND USE
OF COMMUNICATIONS

Synopsis:

Telephone listing for Los Angeles number called by EDWARD L. DUBOIS immediately after arrest of BALLETTI, Las Vegas, Nevada, set out. Telephone listings for Los Angeles numbers called by ROBERT A. MAHEU and J. A. ROWLINS from Miami Beach, Florida 10/11/60 to 10/30/60 set out. JAMES P. CANTILLON, Attorney, Los Angeles, California, advised on 3/1/61 that he received call from BALLETTI when BALLETTI in custody of Las Vegas authorities and as result referred BALLETTI to TOM FOLEY, Attorney, Las Vegas, Nevada. CANTILLON denies any other knowledge of instant case, denies knowing DAN ROWAN or J. W. HARRISON, but knows ROBERT MAHEU.

- P -

Date 2/10/61

On February 10, 1961 the records of the Pacific Telephone and Telegraph Company revealed that telephone number CRestview 1-8770 was listed to ROBERT A. MAHEU, 1510 Gilcrest Drive, Beverly Hills, California.

These records are confidential and can be obtained only by a subpoena duces tecum. The subpoena should be directed to the Pacific Telephone and Telegraph Company, 720 West Seventh Street, Room 510, Los Angeles, California, attention: [REDACTED] b7C

On 2/10/61 at Los Angeles, California File # Los Angeles 139-77

by SA [REDACTED] /sgt [REDACTED] Date dictated 2/10/61

This document contains neither recommendations nor conclusions of the FBI. It is the property of the FBI and is loaned to your agency; it and its contents are not to be distributed outside your agency.

Date 3/6/61

On February 28, 1961 the records of the Pacific Telephone and Telegraph Company revealed that the following telephone numbers were listed as indicated:

FAculty 1-0711 (A trunk off FAculty 1-0710)	Ram Chemical Incorporated 210 East Alondra Boulevard, Gardena, California
OLympia 4-2556 (non-published)	Hughes Productions 1404 North Havenhurst Drive, Los Angeles, California
BRadshaw 2-7061 (non-published)	<i>F/A. Wash. D.C.</i> ROBERT A. MAHEU <i>Robert Maheu</i> 1510 Gilcrest Drive Beverly Hills, California
SYlvan 0-1273	JAMES J. ARDITTO 4245 Chula Senda Lane, Flintridge, California
CRestview 5-5121	Bautzer and Grant Attorneys 190 North Cannon Drive, Beverly Hills, California
OXford. 1-7552 (non-published)	ODEN L. BERRY 10214 South Victoria Avenue Whittier, California
CLinton 6-2251	Sate Farm Insurance Company 1740 Colorado Boulevard Los Angeles, California
Diamond 7-6298	JOSEPH I. BREEN Jr. 5-953 Lubao Woodland Hills, California
LOrain 4-2505	Tucker Founding Company 2514 East 118th Street Los Angeles, California.

On 2/28/61 at Los Angeles, California File # Los Angeles 139-77

by SE [REDACTED] b7c bgt Date dictated 3/3/61

This document contains neither recommendations nor conclusions of the FBI. It is the property of the FBI and is loaned to your agency; it and its contents are not to be distributed outside your agency.

LA 139-77

These records are confidential and can be obtained only by a subpoena duces tecum. The subpoena should be directed to the Pacific Telephone and Telegraph Company, 720 West Seventh Street, Room 410, Los Angeles, California, attention: [REDACTED]

OK

Date 3/6/61

The records of the General Telephone Company on February 28, 1961 revealed that the telephone number TOPAZ 1-0311 was listed to the Southern California Gas Company, 9240 East Firestone Boulevard, Downey, California.

These records are confidential and can be obtained only through a subpoena duces tecum directed to the General Telephone Company, 2020 Santa Monica Boulevard, Santa Monica, California, attention: [REDACTED] b7c

On 2/28/61 at Los Angeles, California File # Los Angeles 139-77
by SE [REDACTED] sgt Date dictated 3/3/61 b7c

Date 3/6/61

Nevada
 Mr. JAMES P. CANTILLON, Suite 438, 9441 Wilshire Boulevard, was advised that he was not required to furnish any information and any information that he did provide would be voluntarily on his part. He related the following:

Beverly Hills Calif *James Cantillon*
 His first knowledge of the microphone incident in Las Vegas, Nevada came with a telephone call to him from a man in custody at Las Vegas. He claimed inability to recall the man's name and said he never before heard of him. When given the name ARTHUR JAMES BALLETTI, CANTILLON acknowledged that name was probably correct, but he advised he had no knowledge of BALLETTI prior to the call which came from the office of a lieutenant in either the Clark County Sheriff's Office or the Las Vegas City Jail. He declined to relate any of the conversation with BALLETTI, claiming privilege. He did say he referred the caller to Attorney TOM FOLEY in Las Vegas, Nevada and that he telephoned FOLEY about the matter. He believed he talked to FOLEY regarding this a week later in person at Las Vegas while there on unrelated business.

He had thought the case against BALLETTI involved simply a microphone installation rather than a telephone tap. He said he never did learn the disposition of the case but did hear from FOLEY that charges had been reduced and that authorities in Las Vegas had kept BALLETTI's equipment. He mentioned he does not know DAN ROWAN. When first called from Las Vegas, he thought BALLETTI was referring to another ROWAN, one of the casino owners in Las Vegas and the thought struck him, "Boy, he must have some juicy tapes."

He said he knew ROBERT MAHEU and he admittedly sees MAHEU in Beverly Hills, California. He denied telephoning or otherwise contacting MAHEU in Washington, D. C. or elsewhere, to ask for him to perform surveillance of DAN ROWAN or for any other purpose having to do with this matter. He denied knowing any person named J. W. HARRISON.

On 3/1/61 at Beverly Hills, California File # Los Angeles 139-77
 by SA [redacted] b7c /sgt Date dictated 3/3/61

FBI

Date: 3/17/61

Transmit the following in PLAIN TEXT
(Type in plain text or code)

Via AIRTEL AIR MAIL
(Priority or Method of Mailing)

TO: DIRECTOR, FBI
FROM: SAC, LAS VEGAS (139-1)
RE: ARTHUR JAMES BALLETTI;
UNSUB, aka J. W. Harrison;
UPUC
(OO: Las Vegas)

FD-217
er 1/5
O

Rerep of SA [redacted] dated 3/6/61
at Los Angeles and Las Vegas airtel to Miami
dated 3/10/61.

b7c

Los Angeles and Miami requested to expedite investigation and furnish results to Las Vegas.

- 3 - Bureau (AIR MAIL)
- 2 - Miami (139-63)(AIR MAIL)
- 2 - Los Angeles (139-77)(AIR MAIL)
- 1 - Las Vegas

REC-72

139-1011-26

MBP/hsl
(8)

23 MAR 20 1961

[Handwritten signatures and initials]

57 MAR 23 1961

Approved: _____ Sent _____ M Per _____
Special Agent in Charge

1007 Mark

FEDERAL BUREAU OF INVESTIGATION

Reporting Office CHICAGO	Office of Origin LAS VEGAS	Date 3/17/61	Investigative Period 3/6 - 9/61
TITLE OF CASE ARTHUR JAMES BALLETTI; UNKNOWN SUBJECT, Aka. J. W. (Harrison)		Report made by [REDACTED] A) b7C	Typed By: meb
		CHARACTER OF CASE UPUC	40-217

REFERENCES: Las Vegas airtel to Bureau, dated 3/1/61.

- RUC -

LEAD

LAS VEGAS

AT LAS VEGAS, NEVADA. An extra copy is provided in the event it is later desired to furnish it to the United States Attorney.

ADMINISTRATIVE

Information regarding [REDACTED] in October, 1940, is reflected in Chicago file entitled, [REDACTED]

b7C
OS

MAR 20 1961

Approved <i>[Signature]</i>	Special Agent In Charge	Do not write in spaces below	
Copies made: ② - Bureau 3 - Las Vegas (139-1) 1 - Chicago (139-105)		139-1211	REC-73
		25 MAR 20 1961	EX-117

0-7 [REDACTED] (in acct. W.P.H.)
3-20-61
E.H. [REDACTED]
COVER PAGE
[REDACTED] (B) 3-21-61 E.H.M. [REDACTED]

CG 139-105

Information obtained from [REDACTED]
on [REDACTED] is contained in Chicago file [REDACTED]
entitled, [REDACTED]

Information obtained from [REDACTED] on [REDACTED]
[REDACTED] contained in Chicago file [REDACTED]
[REDACTED], entitled, [REDACTED]
[REDACTED], office of origin Chicago.

Information obtained by IC [REDACTED]
in [REDACTED] is reflected in Chicago file [REDACTED]
entitled, [REDACTED], office of origin
Los Angeles.

b7C
b7D
OS

UNITED STATES DEPARTMENT OF JUSTICE
FEDERAL BUREAU OF INVESTIGATION

Copy to:

1 - USA, Las Vegas, Nevada

b7c

Report of:

SAA [REDACTED]

Office: Chicago, Illinois

Date:

March 17, 1961

Field Office File No.:

139-105

Bureau File No.:

Title:

ARTHUR JAMES BALLETTI;
UNKNOWN SUBJECT, Aka.

Character:

UNAUTHORIZED PUBLICATIONS OR USE OF
COMMUNICATIONS

Synopsis:

b7c
OS

Telephone number [REDACTED] listed to [REDACTED]
[REDACTED] Chicago, Illinois. [REDACTED] has
invested money in Sand's Hotel; Hotel Freemont
and Tropicana Hotel, Las Vegas, Nevada.

- RUC -

CG 139-105

DETAILS: AT CHICAGO, ILLINOIS

[REDACTED] ^{W 39}
[REDACTED] ^{CAHIF}

On October 18, 1957, [REDACTED] was the victim of a telephonically threatened kidnapping. [REDACTED] at this time resided at [REDACTED] and is described as white, male, American, 5'7", 157 lbs. and was [REDACTED]

On June 13, 1957, [REDACTED] Las Vegas, Nevada, advised that [REDACTED]

b7c
b7D
OS

[REDACTED]

On June 26, 1958, [REDACTED]

[REDACTED] California, advised SA [REDACTED] that [REDACTED] was a close friend of [REDACTED] a member of the club. [REDACTED] has invested money in the Sand's Hotel and Hotel Freemont in Las Vegas and recently was supposed to have a large interest in the Tropicana Hotel which is reportedly under the control of FRANK COSTELLO.

[redacted]
advised Investigative Clerk [redacted] on February 10, 1959, the following information concerning [redacted] is contained in their files:

[redacted] resides at [redacted]
[redacted]
[redacted]

[redacted] reflects that he is married to [redacted] years old (1952) [redacted]

b7C
b7D
OS

A report dated [redacted] reflects that [redacted] and his wife currently reside at [redacted]
[redacted]
[redacted]

[redacted] advised on February 8, 1959, that their records contain no information regarding [redacted]

UNITED STATES GOVERNMENT

Memorandum

TO : DIRECTOR, FBI

DATE: 3/13/61

FROM : SAC, LOS ANGELES (139-77)

SUBJECT: ARTHUR JAMES BALLETTI
UPUC

OO: Las Vegas

FO-217

Re Bureau airtel to Los Angeles, 3/3/61.

Enclosed for the Bureau is a letterhead memorandum consisting of six pages, a copy of which is furnished to the office of origin for information. The sources of information in this letterhead memorandum concerning JAMES P. CANTILLON are identified as follows:

On Page 2, Paragraph 3, the confidential source referred to is PCI [redacted] to SA [redacted] on 1/23/58, Los Angeles file [redacted]

On Page 3, Paragraph 3, the business associate of JAMES P. CANTILLON is [redacted] to SA [redacted] on 3/4/58, Los Angeles file [redacted]

The former business associate of JAMES P. CANTILLON on Page 3, Paragraph 5, is [redacted] to SA [redacted] and SA [redacted] on 4/17,18/58, Los Angeles file [redacted]

The second business associate of JAMES P. CANTILLON on Page 5, Paragraph 3, is [redacted] to SA's [redacted] and [redacted] San Francisco, on 4/26/60, Los Angeles file [redacted]

The businesswoman of Las Vegas, Nevada, on Page 5, Paragraph 5, is [redacted] to SA [redacted] Las Vegas, Nevada, on 5/23/60, Los Angeles file [redacted]

- 2 - Bureau (Encl. 4)
 - 1 - Las Vegas (Info) (Encl. 1)
 - 1 - Los Angeles
- MEG/slm
(4)

REC-68

EX-114

MAR 17 1961

1cc. C.R. Unit
1cc. A.C. [redacted]
1cc. G-3 (B) [redacted]

63 MAR 27 1961



UNITED STATES DEPARTMENT OF JUSTICE
FEDERAL BUREAU OF INVESTIGATION

Los Angeles, California

March 13, 1961

In Reply, Please Refer to
File No.

JAMES P. CANTILLON

The Martindale-Hubbell Law Directory, Volume 1, 1961, Pages 182 and 183, sets out the following information concerning JAMES P. CANTILLON:

Cantillon and Cantillon, Suite 438, California Bank Building, 9441 Wilshire Boulevard, Beverly Hills, California, telephone numbers CRestview 6-6885 and BRadshaw 2-4386, is a law firm engaging in the General and Trial Practice and Federal Courts. The firm is made up of RICHARD H. CANTILLON, born Chicago, Illinois, September 16, 1898, an associate member, R. MICHAEL CANTILLON, born Los Angeles, California, February 3, 1928, and JAMES P. CANTILLON, born Los Angeles, California, January 18, 1927. JAMES P. CANTILLON was admitted to the California Bar and United States District Court in 1951. His preparatory education was taken at the University of California at Los Angeles, California, and his legal education at Loyola University of Law, Los Angeles, California, receiving an LLB in 1951. His fraternity was listed as Phi Delta Phi. He was listed as Advocate and Director of the American Board of Trial Advocates, 1958. He was listed as a member of the Beverly Hills - Los Angeles County Bar Association (member, Committee on Criminal Law, 1955), American Bar Association (member, Committee on Criminal Law and Procedure, 1959), the Criminal Court Association, and the State Bar of California.

JAMES P. CANTILLON
b7D
b7C
The records of the [REDACTED] 11-1-1961

[REDACTED] contain information regarding JAMES PATRICK CANTILLON, described as age 20 in 1947, 5'10", 165 pounds, brown hair, hazel eyes, [REDACTED] His residence was listed as 11610 Bellagio Road, Los Angeles, California, his birth place as California, and his father as RICHARD CANTILLON of 11610 Bellagio Road, Los Angeles, California.

SEARCHED INDEXED SERIALIZED FILED
MAR 14 1961
FBI - LOS ANGELES

CLOSURE
1101-3

b6
b7C
b7D
OS

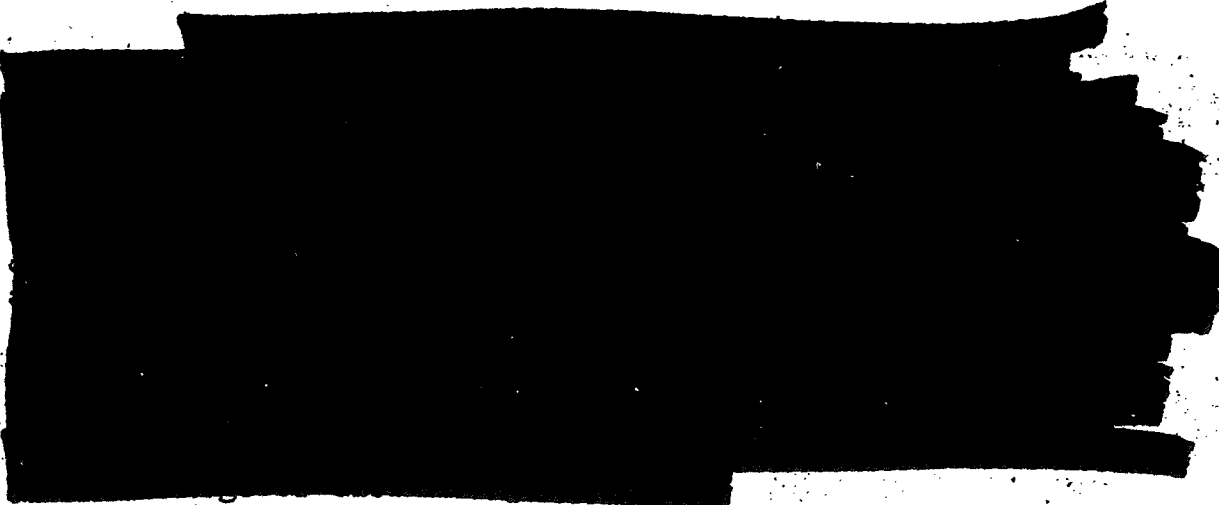

While conducting official investigations, the Los Angeles Office of the Federal Bureau of Investigation has been the recipient of reported information concerning JAMES P. CANTILLON, a summary of which is set out below:

b7D
OS

[REDACTED]
a Special Agent of the Los Angeles Office of the Federal Bureau of Investigation that JOHN ROSELLI stayed at the Beverly Hilton Hotel when he came into Los Angeles and that he visits with an Attorney, JAMES CANTILLON, 9441 Wilshire Boulevard, Beverly Hills, California.

b7D
OS

The JOHN ROSELLI [REDACTED] referred to and who will be further referred to in this communication is identified as JOHN ROSELLI, also known as John Rosselli, John Rasselii, John Russell, John F. Stewart, Rand Field, and Giovanni Rosselli.

Records of the Los Angeles, California, Police Department reveal that JOHN ROSELLI, FBI Number 3339986, was first arrested by the Los Angeles Police Department in 1924 for carrying concealed weapons, but the charge was dismissed. During the period from 1924 to 1932 he was arrested on several occasions on charges of suspicion of grand larceny, carrying concealed weapons, and robbery.

In testimony before the Kefauver Committee in October, 1950, ROSELLI advised he met AL CAPONE in Chicago, Illinois, at the Dempsey-Tunney fight, and that he spent a day with CAPONE in Los Angeles, California, about 1930.

Records of the United States Immigration and Naturalization Service, Los Angeles, California, indicate that JOHN ROSELLI claims birth in Chicago, Illinois, on July 4, 1904.

The records of the United States District Court, New York City, indicate that on December 22, 1943, ROSELLI was found guilty of violation of Section 402A, Title 18, United States Code, and sentenced to ten years imprisonment. He was released on parole after serving one third of his sentence. The charge involved the extorting of money from motion picture producers to insure the studios against labor strikers.

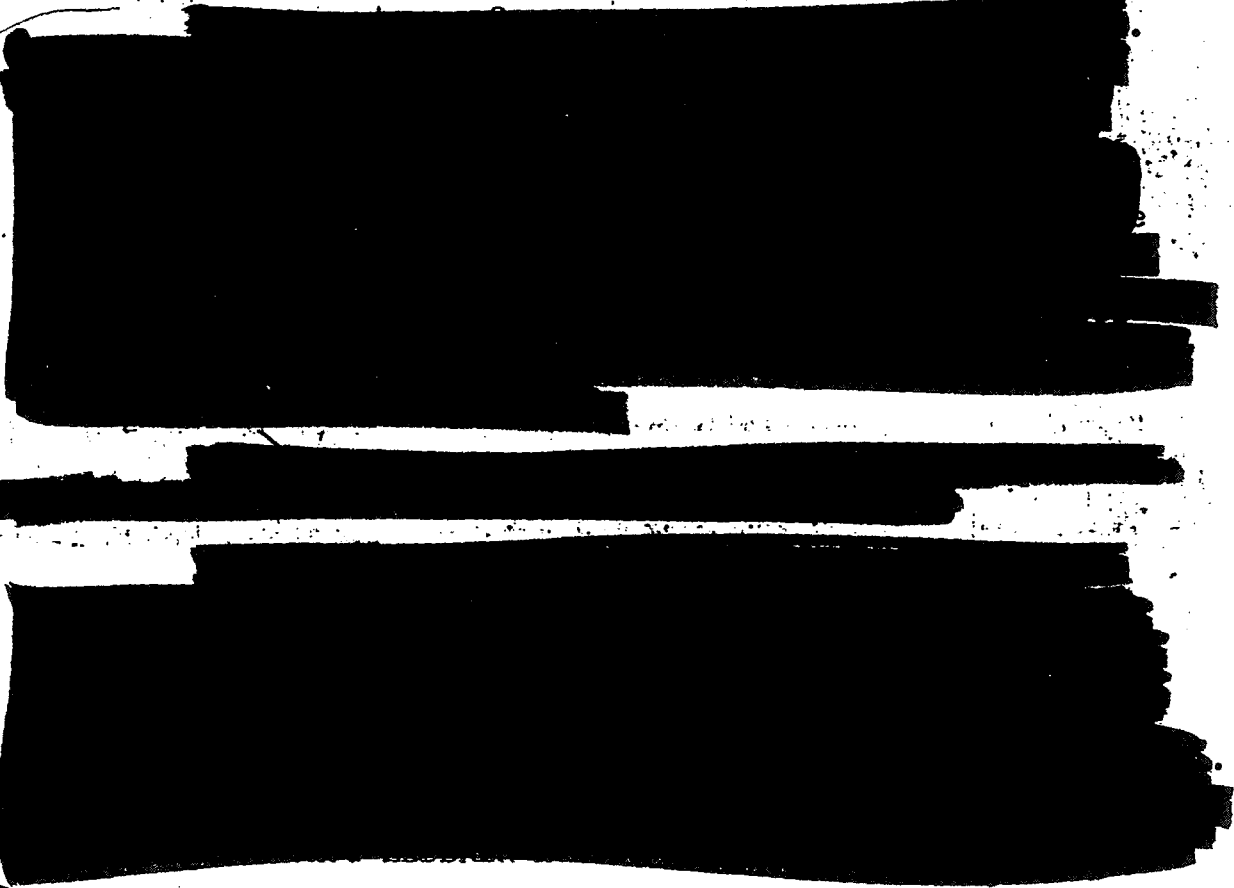

b7C
b7D
OS

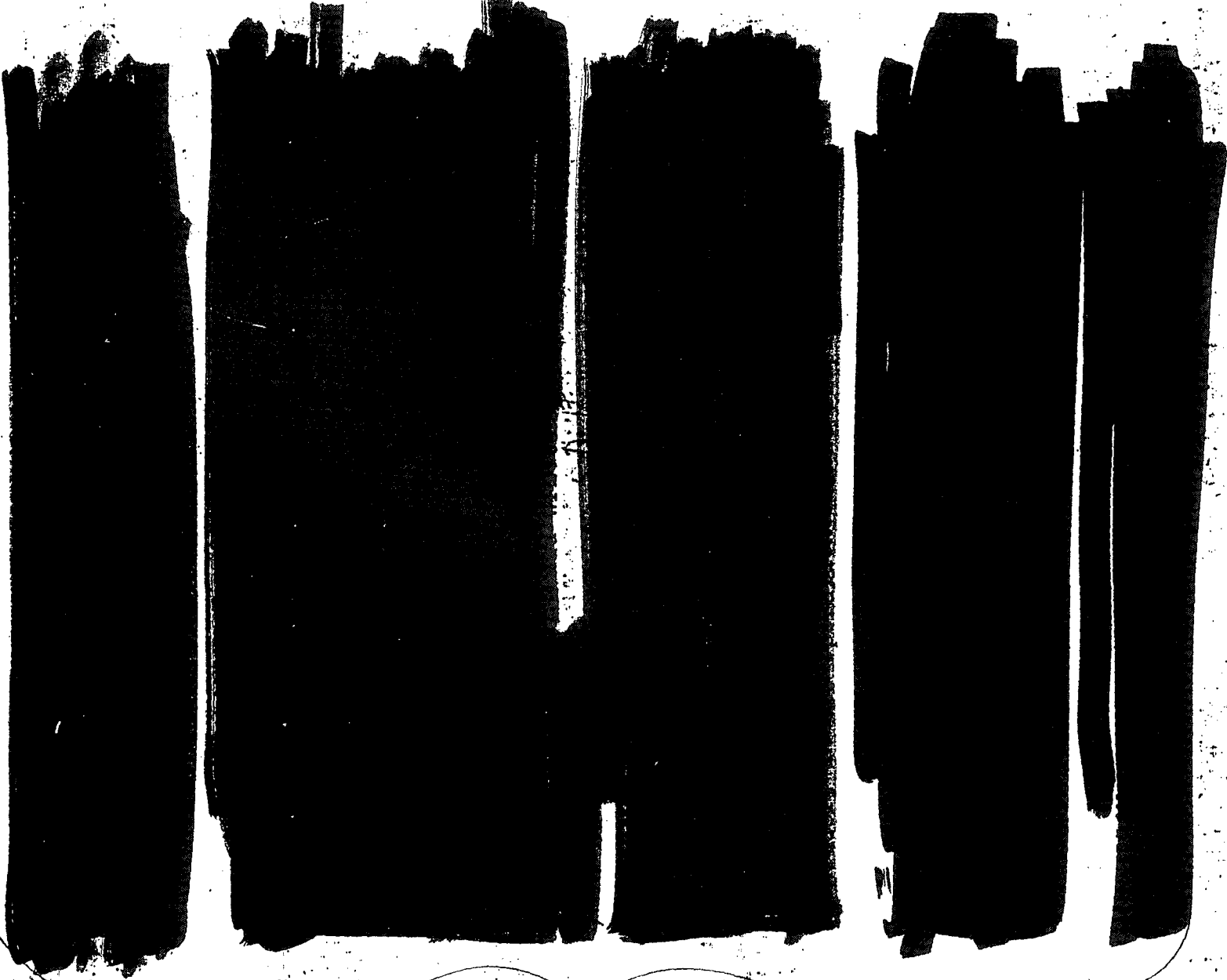

OS 67C
67C

[REDACTED]

[REDACTED]

[REDACTED]

[REDACTED]

[REDACTED]

b7C
b7D
OS

The source advised that JAMES CANTILLON was an attorney from Los Angeles, California, and had represented JOHN ROSELLI in the past.

This document contains neither recommendations nor conclusions of the FBI. It is the property of the FBI and is loaned to your agency; it and its contents are not to be distributed outside your agency.

F B I

Date: 3/20/61

PLAIN TEXT

Transmit the following in _____

(Type in plain text or code)

Via AIRTEL

AIRMAIL

(Priority or Method of Mailing)

TO: Director, FBI (139-1201)

FROM: SAC, Miami (139-63)

RE: ARTHUR JAMES BALLETTI;
ET AL
UPUC
(OO - Las Vegas)

EDWARD L. DU BOIS, JR., in re-interview reaffirmed the statement and produced American Express charges to support claim that ARTHUR BALLETTI and another individual, known only to him as J. HARRISON, left Miami 10/25/60, for Los Angeles, Calif., where they caught another plane to Las Vegas, Nev. Claims BALLETTI and HARRISON used return portions of tickets. Denies that HARRISON worked for him; claims HARRISON an employee of MAYHEW.

Re \$1,000.00 MAYHEW paid DU BOIS, DU BOIS claims that MAYHEW, while in Los Angeles on 10/31/60, telephonically contacted BALLETTI at Las Vegas and instructed him to go either to the Dunes or Flamingo Hotel, Las Vegas, and contact a Mr. RICHARDSON, and that RICHARDSON would pay BALLETTI \$1,000.00 in cash. BALLETTI told DU BOIS that RICHARDSON allegedly well known at hotel and may be either owner or manager.

List of equipment confiscated at time of BALLETTI's arrest reviewed with DU BOIS. DU BOIS admits owning Minox

P.
3 - Bureau (AM)
2 - Las Vegas (139-1) (AM)
2 - Miami
RMM:cms
(7)

REC-61

139-1201-29

25 MAR 29 1961

57 MAR 27 1961

Approved: _____

Special Agent in Charge

Sent _____

M

Per _____

C. C. Wick

F B I

Date:

Transmit the following in _____
(Type in plain text or code)Via _____
(Priority or Method of Mailing)

MM 139-63

camera, 35 mm Minifon camera, and Minifon tape recorder. Claims that this equipment is standard with his operators on a case. DU BOIS claims that MAYHEW has hired attorney who is brother-in-law of Attorney General in Nevada to defend BALLETTI, and expects charges against BALLETTI to be dropped. BALLETTI is still out of town on case and is not expected to return until 3/25/61, at which time he will be interviewed at earliest opportunity and report will be submitted.

Registration card of J. A. ROLLINS at Kenilworth Hotel obtained and being sent FBI Laboratory under separate cover.

- 2 -

Approved: _____ Sent _____ M Per _____
Special Agent in Charge

UNITED STATES GOVERNMENT

Memorandum

TO : DIRECTOR, FBI (139-1201)
Attention: FBI LABORATORY

DATE: 3/22/61

200/1038

FROM : SAC, MIAMI (139-63)

SUBJECT: ARTHUR JAMES BALLETTI;
UNSUB., aka J. W. Harrison
UPUC
(OO: Las Vegas)

363090

Re Las Vegas airtel to the Bureau dated 3/1/61.

b7C

On 3/17/61, [REDACTED] Kenilworth Hotel, Bal Harbor, Florida, made available Kenilworth Hotel Registration Card #8009, which contained the following printed name and address:

J. A. ROLLINS
1125 19th St., N. W.
Washington, D. C.

This card is dated 10/11/60. The FBI Laboratory is requested to compare the printing on this card with the printing or writing on the Registration Card of the Riviera Hotel, which contained the name J. W. HARRISON. At the conclusion of the examination, the Kenilworth Hotel Registration Card should be returned to the Miami Division so that it may be returned to the hotel.

*COPY AND SPECIMENS
RETAINED IN LAB*

- P.
- 3 - Bureau (Encl. 1)
- 1 - Las Vegas (139-1)(Info)
- 2 - Miami
- RMI:bam
- (6)

REC-61

EX-108

DEPT. OF JUSTICE

MAR 24 1961

INDEX LABELS

ENCLOSURE

[Handwritten signatures and initials]

[Handwritten signatures and initials]

[Handwritten signatures and initials]

COPIES

Recorded
3-29-61 JWW

FEDERAL BUREAU OF INVESTIGATION
UNITED STATES DEPARTMENT OF JUSTICE

Laboratory Work Sheet

NO LAB FILE

Re: ARTHUR JAMES BALLETTI;
Unsub, aka
J. W. HARRISON
UPUC

File # ~~XXXXXXXX~~ 139-1201
Lab. # D-363090 HW

Examination requested by: FBI, Miami (139-63) Letter 3-22-61

Examination requested: Document Date received: 3-24-61

Result of Examination: Examination by: 

MAR 30 1961

b7c

Specimens submitted for examination

Q1-- Registration card for The Kenilworth Hotel No. 8009,
dated 10-11-60, in the name of J. A. ROLLINS

4173

ROLLINS

Welcome!

Kenitworth

No. 8009

OCT 11 PM 4:52 195

Name J. A. ROLLINS
Address 1125 19th St., N.W.
City WASHINGTON, D.C.

MONEY, JEWELS AND OTHER VALUABLE PACKAGES MUST BE DEPOSITED AT THE OFFICE, TO BE KEPT IN THE SAFE, OTHERWISE THE MANAGEMENT WILL NOT BE RESPONSIBLE FOR ANY LOSS.

DATE OF ARRIVAL	A. M.	ROOM	RATE	CLERK	DATE OF DEPARTURE
		701		ET	
	P. M.	NO. OF GUESTS		ACCT. NO.	
		1	13.00		

REMARKS:

Street

4019 days

1950 OCT 11 PM 4:52

139-1201 01 HW



FEDERAL BUREAU OF INVESTIGATION
WASHINGTON, D. C.

To: **FBI, Miami (139-63)**

Date **April 3, 1961**

Re: **ARTHUR JAMES BALLETTI;
Unsub, aka J. W. HARRISON
UPUC**

Handwritten signature: J. Edgar Hoover
John Edgar Hoover, Director

REC-91

FBI File No. **139-1201-30**
Lab. No. **D-363090 HW**

Examination requested by: **Miami**

Reference: **Letter 3-22-61**

Examination requested: **Document**

Remarks:

No record was located in regard to the submission of the registration card bearing the name J. W. HARRISON mentioned in the referenced letter. If a comparison is still desired, specific information should be furnished to the Bureau as to the caption under which the registration card was submitted and the date of submission.

Enclosures (3) (Q1, 2 Lab report)

1 - Las Vegas (139-1) Enclosure (Lab report)

EX 104

- Tolson _____
- Prison _____
- Mohr _____
- Belmont _____
- Callahan _____
- Conrad _____
- DeLoach _____
- Evans _____
- Malone _____
- Rosen _____
- Tavel _____
- Trotter _____
- W.A. Sullivan _____
- Tele. Room _____
- Ingram _____
- Gandy _____

APR 4 - 1961
COMM. DIV. 91

APR 4 1961 (5)

1961

MAIL ROOM TELETYPE UNIT

Handwritten signature and initials

REPORT
of the



FEDERAL BUREAU OF INVESTIGATION
WASHINGTON, D. C.

To: **FBI, Miami**
Re: **ARTHUR JAMES BALLETTI;
Unsub, aka J. W. HARRISON
UPUC**

Date: **April 3, 1961**
FBI File No. **139-1201**
Lab. No. **D-363090 HW**

Specimens received **3-24-61**

Q1 Registration card for The Kenilworth Hotel No. 8009,
dated 10-11-60, in the name of J. A. ROLLINS

Result of examination:

The name on Q1 was searched in the signature section
of the National Fraudulent Check File without effecting an
identification.

Specimen Q1 is returned herewith to Miami.
This item has been photographed.

- Tolson _____
- Parsons _____
- Mc _____
- Belmont _____
- Callahan _____
- Conrad _____
- DeLoach _____
- Evans _____
- Malone _____
- Rosen _____
- Tavel _____
- Trotter _____
- W.C. Sullivan _____
- Tele. Room _____
- Ingram _____
- Gandy _____

TAD: JWW (5)

MAIL ROOM TELETYPE UNIT

Recorded
3-29-61 JWW

FEDERAL BUREAU OF INVESTIGATION
UNITED STATES DEPARTMENT OF JUSTICE

Laboratory Work Sheet

NO LAB FILE

Re: ARTHUR JAMES BALLETTI;
Unsub, aka
J. W. HARRISON
UPUC

File # ~~XXXXXXX~~ 139-1201
Lab. # D-353090 HW

Examination requested by: FBI, Miami (139-63) Letter 3-22-61

Examination requested: Document Date received 3-24-61

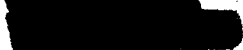
Result of Examination: Examination by: 

b2 c

In detail report NCF.
In record found of reg. card for J.W. Harrison
Rollins Pl. Keep photo.

3-31-61
[Signature]

Specimens submitted for examination

01... Registration card for The Kenilworth Hotel No. 3009,
dated 10-11-60, in the name of J. A. ROLLINS

6-2-61
J. W. Harrison
4/3/61

FEDERAL BUREAU OF INVESTIGATION

Reporting Office WASHINGTON FIELD	Office of Origin LAS VEGAS	Date MAR 27 1961	Investigative Period 1/19, 30; 2/8; 3/1/61
TITLE OF CASE ARTHUR JAMES BALLETTI; UNSUB; aka J. W. Harrison		Report made by [REDACTED] b7C	Typed By: ddt
		CHARACTER OF CASE UPUC	

XXXXXX

REFERENCES

Reports of SA [REDACTED] dated 1/28/61 and 2/14/61, at Miami; SUairtel to the Director, 2/7/61; LVairtel to the Director, 3/1/61.

- RUC -

ADMINISTRATIVE DATA

^{b2}
^{b7D} On [REDACTED] furnished SA [REDACTED] the following telephone number listings:

JE 3-7277

Robert A. Maheu
ROBERT A. MAHEU, 1025 Beachwood Lane, Falls Church, Virginia, nonpublished number, business service since 1958, also has residence service on JE 3-9655.

FE 8-8500

Maheu and King Associates, Inc., 1125 - 19th Street, N.W.

Approved <i>[Signature]</i>	Special Agent In Charge	Do not write in spaces below	
Copies made:		138-1001-31	REC-8
<ul style="list-style-type: none"> ② - Bureau (139-1201) 3 - Las Vegas (139-1) <ul style="list-style-type: none"> (1 - USA, Reno, Nevada) 1 - Miami (139-63)(Info) 1 - Washington Field (139-61) 		31 MAR 28 1961	

Las Vegas District Office

62 APR 6 1961

WFO 139-61

EX 3-6115

Central Intelligence Agency,
2430 E Street, N.W.

JA 3-1441

No JA 3 exchange in Washington metropolitan area. JE 3-1441 listed to JOSEPH BOYLE, 4013 Westmorland Street, McLean, Virginia.

MU 6-6000

No MU 6 exchange in the Washington metropolitan area.

CL 6-1891

JAMES P. O'CONNELL, JR., 826 Whispering Lane, Falls Church, Virginia.

EX 3-4900

General Services Administration (U.S. Government), General Services Building, 18th and F Streets, N.W.

LO 6-9660

No LO 6 exchange in the Washington metropolitan area.

OL 4-4284

EDWARD P. MORGAN, 6004 Brookside Drive, Kenwood, Maryland.

ME 8-6565

A multiple listing in the names of the following attorneys, Suite 1004, 839 - 17th Street, N.W:

RAYMOND W. BERGAN, VINCENT J. FULLER,
JOHN W. GUIDER, CHARLES P. MULDOON,
AGNES A. NEILL, JOHN A. SELBY,
COLMAN B. SLEIN, HAROLD UNGAR, THOMAS
A. WADDEN, JR., EDWARD BENNETT WILLIAMS.

WFO files reflect that JAMES P. O'CONNELL, JR., resigned as a Special Agent of the FBI on 11/30/51.

b3
per
CIA
b7c
b7D
[REDACTED]

WFO files further reflect that EDWARD P. MORGAN is a former Special Agent of the FBI. By letter dated 4/27/55, the Bureau advised that MORGAN, a former Special Agent and presently a Washington, D. C., attorney, is not to be contacted without Bureau authority.

WFO 139-61

The current Washington Metropolitan Area Telephone Directory reflects EDWARD P. MORGAN, 6004 Brookside Drive, Telephone Number OL 4-4284, an attorney at 710 - 14th Street, N.W., Telephone Number ST 3-0511.

Files of WFO and records of the Credit Bureau failed to reflect information on [REDACTED]

b7C
OS

UNITED STATES DEPARTMENT OF JUSTICE
FEDERAL BUREAU OF INVESTIGATION

Copy to: 1 - USA, Reno, Nevada

Report of: [REDACTED] b7C

Office: Washington, D. C.

Date: MAR 27 1961

Field Office File No.: 139-61

Bureau File No.: 139-1201

Title: ARTHUR JAMES BALLETTI;
UNKNOWN SUBJECT; aka J. W. Harrison

Character: UNAUTHORIZED PUBLICATION OR USE OF COMMUNICATIONS

Synopsis:

ROBERT MAHEU, Maheu and King Associates, Incorporated, unable to secure permission from the Los Angeles attorney to furnish his name to the FBI for interview purposes. MAHEU states that it is now his recollection that WALTER FITZPATRICK originally contacted EDWARD DUBOIS regarding the request of the Los Angeles attorney but denied instructing DUBOIS as to how to handle the matter and denies that he supplied an employee to assist in this investigation. MAHEU identified J. A. ROLLINS as JOHN A. ROLLINS. MAHEU would not further identify ROLLINS except to state that ROLLINS was working indirectly for MAHEU in Miami.

- RUC -

Date January 24, 1961

ROBERT MAHEU, Maheu and King Associates, Incorporated, 1125 - 19th Street, N.W., advised that since the identity of the Los Angeles, California, attorney who originally contacted him is needed for interview purposes, he would attempt to secure permission from this attorney to furnish his name to the FBI. MAHEU stated that he would contact the attorney and would advise the Washington Field Office when he had this information.

On 1/19/61 at Washington, D. C. File # WFO 139-61
by b7C SA [REDACTED] /ddt Date dictated 1/20/61

This document contains neither recommendations nor conclusions of the FBI. It is the property of the FBI and is loaned to your agency; it and its contents are not to be distributed outside your agency.

Date January 30, 1961

On January 27, 1961, the office of ROBERT MAHEU, Maheu and King Associates, Incorporated, 1125 - 19th Street, N.W., was telephonically contacted in an effort to locate Mr. MAHEU. It was ascertained that Mr. MAHEU was not in his office and word was left to have Mr. MAHEU contact the Washington Field Office upon his return.

b7c On January 30, 1961, ROBERT MAHEU telephonically contacted SA [REDACTED] and advised that he had been in touch with the attorney in Los Angeles, California, by telephone but that this attorney did not desire to have his name furnished to the FBI.

Mr. MAHEU advised that he is leaving Washington, D.C., on January 30, 1961, to go to Los Angeles, California, on business and while there will talk further with the attorney in an attempt to secure his permission to furnish his name to the FBI.

b7c It was suggested to Mr. MAHEU that upon receipt of this permission that MAHEU contact the Los Angeles Office of the FBI and furnish them this information. Mr. MAHEU stated that he will be returning to Washington within a few days and will furnish the information to the Washington Field Office upon his return. Mr. MAHEU stated that in the event he is delayed in returning to Washington he will telephonically contact SA [REDACTED] in the Washington Field Office from Los Angeles.

Mr. MAHEU stated that he "is in the middle of this thing" as he is "the only person who knows the attorney's name." He stated that he would make every effort to secure the permission of the attorney to divulge his name to the FBI.

On 1/27/61
1/30/61 at Washington, D. C. File # WFO 139-61

b7c by SA [REDACTED] / ddt Date dictated 1/30/61

Date February 13, 1961

ROBERT MAHEU, Maheu and King Associates, Incorporated, 1125-19th Street, N. W., advised that he had just returned from Los Angeles, California, and after talking to the Los Angeles attorney who had originally requested him to contact EDWARD DUBOIS, he had been unable to secure permission from this attorney to divulge his name to the FBI. Mr. MAHEU stated that the Los Angeles attorney had advised him that he did not desire to become involved in this matter.

Mr. MAHEU further stated that after discussing the matter with WALTER FITZPATRICK, an associate of his, it is now his recollection that FITZPATRICK had made the original contact with EDWARD DUBOIS in Miami, Florida, regarding the request of the Los Angeles attorney to secure someone to do some investigating work for him in Las Vegas, Nevada. Mr. MAHEU emphatically denied that he or FITZPATRICK had later contacted DUBOIS requesting DUBOIS to send only one man to Las Vegas and instructing DUBOIS that he, MAHEU, would furnish the second man.

Mr. MAHEU stated that he stayed at the Kenilworth Hotel in Miami Beach, Florida, during the latter part of October, 1960. He recalled that he had contacted DUBOIS while in Miami Beach but denied that he had told DUBOIS that he was staying at the Kenilworth Hotel nor on this occasion did he instruct DUBOIS to send only one man to Las Vegas. Mr. MAHEU again stated that his only involvement in this matter was to have DUBOIS contacted at the request of the Los Angeles attorney. He denied that he had instructed DUBOIS on how to handle the matter and emphatically denied that he had supplied any employee to assist in this investigation. Mr. MAHEU stated that he did receive \$1,000 from the Los Angeles attorney which he immediately turned over to DUBOIS. He stated that he had made no money in connection with this matter and never changed the original arrangements that FITZPATRICK had made with DUBOIS on the original call to DUBOIS.

Mr. MAHEU identified J. A. ROLLINS, who was with MAHEU at the Kenilworth Hotel, as JOHN A. ROLLINS. Mr. MAHEU would not identify ROLLINS further as to ROLLINS being an employee of MAHEU, stating that ROLLINS was working indirectly for him in Miami. Mr. MAHEU further denied that ROLLINS was the individual who went to Las Vegas to assist BALLETTI. He

On 2/8/61 at Washington, D. C. File # WFO 139-61

by SA [REDACTED] b7c ddt Date dictated 2/10/61

WFO 139-61

stated that the Kenilworth Hotel records would reflect that ROLLINS was in Miami Beach during the period that BALLETTI was in Las Vegas.

b7c Shortly after completing the above interview, Mr. MAHEU telephonically contacted SA [REDACTED] at the Washington Field Office stating that "he had just received a telephone call and if this matter could be held up for a few days it would be all straightened out." Mr. MAHEU was asked if he would again contact the Washington Field Office regarding this matter to which he advised that the matter would be handled through other channels.

WFO 139-61

On February 13, 1961, a review of the Washington Metropolitan Area Telephone Directory for 1960-61 and the Polk's Washington City Directory for 1960, failed to reflect a JOHN A. ROLLINS identifiable with the JOHN A. ROLLINS mentioned by MAHEU. It is noted that the address 1125 19th Street, N.W., reflected as the address of ROLLINS at the Kenilworth Hotel, Miami Beach, Florida, is the office address of Maheu and King Associates, Washington, D. C.

On February 13, 1961, the records of the Credit Bureau, Incorporated, failed to reflect or identify a JOHN A. ROLLINS.

UNITED STATES GOVERNMENT

Memorandum

TO : DIRECTOR, FBI (139-1201)

DATE: 3/28/61

gfw

FROM : SAC, LAS VEGAS (139-1)

ATTN: FBI LABORATORY

SUBJECT: ARTHUR JAMES BALLETTI;
UNSUB, aka J. W. Harrison
UPUC
(OO: Las Vegas)

363646

BALLETTI was arrested by the Clark County Sheriff's Office, Las Vegas, Nevada on 10/31/60 on the charge of Invasion of Privacy and other charges, after equipment was located in BALLETTI's room, which reflected a technical surveillance had been placed on DAN ROWAN's room at the Riviera Hotel, in Las Vegas.

Another individual, unknown subject J. W. HARRISON, registered at the Riviera on 10/26/60 with BALLETTI. Efforts to identify this individual have been unsuccessful thus far.

Investigation has reflected that one JOHN A. ROLLINS, an employee of ROBERT MAHEU, a private investigator from Washington, D.C., might possibly be identical with HARRISON.

Enclosed herewith is a Riviera Hotel Reservation Card No. 192650, which contains the handwriting of unknown subject J. W. HARRISON written at the date he registered at the Riviera on 10/26/60. It is noted that the time of 10/25/60 was written by the room clerk at the Riviera on the front of the card while the rear of the card shows a date stamp of 10/26/60.

Laboratory is requested to compare the handwriting on the enclosed Riviera Hotel Card with the handwriting on registration card from the Kenilworth Hotel, Miami Beach, in the name of J. A. ROLLINS, which is being submitted by Miami.

Laboratory is requested to advise Las Vegas and Miami the results of this examination.

The Riviera card should be returned to Las Vegas upon completion of the examination.

cy 2
SPECIMENS RETURNED IN LAB.

- P
- 2 - Bureau (Enc. 1) (REGISTERED)
- 1 - Miami (Info) (139-33)
- 1 - Las Vegas

NBP/hsl
(4)

INDEXED

REC-95

139-241-30
MAR 31 1961

[Handwritten signatures and initials]

RECORDED

4-4-61

cm

FEDERAL BUREAU OF INVESTIGATION
UNITED STATES DEPARTMENT OF JUSTICE

NO LAB FILE

Laboratory Work Sheet

Re: ARTHUR JAMES BALLETTI;
Unsub, aka J. W. HARRISON
UPUC

File # 139-1201-32
Lab. # 363646 HW

Examination requested by: FBI, Las Vegas (139-1)

3-28-61

Examination requested: Document

Date received: 3-31-61

Result of Examination:

Examination by: 
b7c

APR 11 1961

Specimens submitted for examination

Q2 Riviera Hotel Reservation Card No. 192650, bearing the
signature of J. W. HARRISON

RETURN EVIDENCE

1099

1 ENCL

.26 5 JAN '60

139-1201 Q2 HW



The Las Vegas
RIVIERA

No 192650

NAME *J. W. Harrison*
STREET *214 W Water St.*
CITY and STATE *San Francisco Calif.*

W/BALLETT

I have read and understand the provisions of this Hotel's policy as to deposit and when making same, I understand that for suits and for garments of such nature as unbutton shirts and small suits, they be treated for safe keeping and unless to the contrary be designated with it to be custom made, I will not be responsible for loss for any loss of or damage to such articles nor in any case for more than the sum of \$250.00 for any and all such property of any individual.

334
750
ROOM RATE NO OF GUESTS
10/25 *10.00* *2*
DATE DEPARTURE DATE CLEF.

139-1201 Q2 HW



FEDERAL BUREAU OF INVESTIGATION
WASHINGTON, D. C.

To: **FBI, Las Vegas (139-1)**

Date: **April 11, 1961**

Re: **ARTHUR JAMES BALLETTI;
Unsub, aka J. W. HARRISON
UPUC**

John Edgar Hoover
John Edgar Hoover, Director

REC-16

EX-100

FBI File No. **139-1201-302**
Lab. No. **D-363646 HW**

Examination requested by: **Las Vegas**
Reference: **Letter 3-28-61**
Examination requested: **Document**
Remarks:

Enclosures (3) (1 QTR, 1 Lab report)
1 - Miami (139-63) Enclosure (Lab report)

- Tolson _____
- Parsons _____
- Mohr _____
- Belmont _____
- Callahan _____
- Conrad _____
- DeLoach _____
- Evans _____
- Malone _____
- Rosen _____
- Tavel _____
- Tracy _____
- W.C. Sullivan _____
- Tele. Room _____
- Ingram _____
- Gandy _____

FAD:cm (5)

MAILED 21 3 11 PM '61
APR 12 1961
COMM-FBI

APR 17 1961

Gr. Donoghue 5732

MAIL ROOM TELETYPE UNIT

REPORT
of the



FEDERAL BUREAU OF INVESTIGATION
WASHINGTON, D. C.

To: **FBI, Las Vegas**
Re: **ARTHUR JAMES BALLETTI;**
Unsub, aka J. W. HARRISON
UPUC

Date: **April 11, 1961**
FBI File No. **139-1201**
Lab. No. **D-363646 HW**

Specimens received **3-31-61**

Q2 Riviera Hotel Reservation Card No. 192650, bearing the signature J. W. HARRISON

Result of examination:

On March 22, 1961, the Miami Division submitted a registration card of the Kenilworth Hotel bearing the hand printed name J. A. ROLLINS. This specimen was designated Q1.

The hand printing on Q1 is not comparable with the handwriting on Q2. As a result, it was not determined whether Q1 and Q2 were or were not prepared by the same individual.

Specimen Q2 is returned herewith to Las Vegas. This item has been photographed.

- Tolson _____
- Parsons _____
- Mohr _____
- Belmont _____
- Callahan _____
- Conrad _____
- DeLoach _____
- Evans _____
- Malone _____
- Rosen _____
- Tavel _____
- Trotter _____
- W.C. Sullivan _____
- Tele. Room _____
- Ingram _____
- Gandy _____

TAD:cm (5)

MAIL ROOM TELETYPE UNIT

RECORDED
4-4-61
cm

FEDERAL BUREAU OF INVESTIGATION
UNITED STATES DEPARTMENT OF JUSTICE

NO LAB FILE

Laboratory Work Sheet

Re: ARTHUR JAMES BALLETTI;
Unsub, aka J. W. HARRISON
UPUC

File # 139-1201
Lab. # 363646 HW

Examination requested by: FBI, Las Vegas (139-1)

3-28-61

Examination requested: Document

Date received: 3-31-61

Result of Examination:

Examination by: [redacted] b7c

*Q1. Riviera Hotel reservation card for J.W. Harrison, probably
made 3/27/61. Hq at motel approx 4/10/61.*

Return 4/22. Hq for JWB.

*4-10-61
[signature]*

Specimens submitted for examination

Q2 Riviera Hotel Reservation Card No. 192650, bearing the
signature of J. W. HARRISON.

*Submitted
4-11-61
TAMM*

RETURN EVIDENCE

328

FBI

Date: 3/29/61

AIRTEL

Transmit the following in _____
(Type in plain text or code)

Via _____
(Priority or Method of Mailing)

TO: DIRECTOR, FBI (139-1201)

FROM: SAC, MIAMI (139-63)

ARTHUR JAMES BALLETTI;
UNSUB, aka., J.W. Harrison
UPUC
(OO: Las Vegas)

BALLETTI re-interviewed this date and denied any knowledge of technical equipment confiscated at the time of his arrest. Claims he brought Minifone Recorder 35 mm Camera and Minox Camera to Las Vegas with him. Reiterates he received \$1,000.00 cash fee from T.W. RICHARDSON at New Frontier Motel, Las Vegas. Maintains he has no knowledge of HARRISON's true identity.

Report in dictation.

- P
- (3) - Bureau (AM) 100-1
- 1 - Las Vegas (139-1)(Info)
- 2 - Miami
- RMM:jll
- (6)

REC-95 139-1201-33

5 MAR 31 1961

EX 104

cc - Wick

Mc [unclear]
[unclear]

Approved: [Signature]
Special Agent in Charge

Sent _____ M Per _____

APR 6 1961

FEDERAL BUREAU OF INVESTIGATION

Reporting Office MIAMI	Office of Origin Las Vegas LAS VEGAS	Date 4/6/61	Investigative Period 2/28-3/29/61
TITLE OF CASE ARTHUR JAMES BALLETTI; UNSUB, aka. J. W. Harrison		Report made by <div style="background-color: black; width: 150px; height: 15px;"></div> b7c	Typed By neb
		CHARACTER OF CASE UPUC	

EXHIBIT

REFERENCE: Miami airtel to Las Vegas, 2/28/61;
 Las Vegas airtel to Director, 3/1/61;
 Las Vegas airtel to Miami, 3/10/61;
 Miami airtel to Director, 3/20/61;
 Las Vegas airtel to Director, 3/17/61;
 Miami airtel to Las Vegas, 3/21/61;
 Las Vegas airtel to Miami, 3/21/61;
 Miami letter to Director, 3/22/61.

- RUC -

Approved <i>Wesley H. Trapp</i> Special Agent In Charge	Do not write in spaces below
Copies made: 2 - Bureau (139-1201) 3 - Las Vegas (139-1) (1 - USA, Las Vegas) 1 - Washington Field (139-61) (info) 1 - Los Angeles (139-77) (info) 1 - Miami (139-63)	139-1201-94 APR 21 1961 REC-25
	APR 21 1961
	APR 21 1961

cc: AAG Civil Rights Division
 Form 6-94

51 APR 17 1961

Property of FBI - This report is loaned to you by the FBI, and neither it nor its contents are to be distributed outside the agency to which loaned.

MM 139-63

LEADS

LAS VEGAS:

AT LAS VEGAS, NEVADA

Will attempt to identify T. W. RICHARDSON, New Frontier Hotel, and interview him concerning the \$1,000.00 fee which he gave to BALLETTI.

It should be noted that ROBERT MAHEU previously advised that he paid \$1,000.00 fee to EDWARD L. DUBOIS, Jr., in Miami. DUBOIS denies this.

ADMINISTRATIVE

b7C
This is a joint investigation of Special Agents [redacted] and [redacted]

Information copies of this report are being furnished to Los Angeles and Washington Field for reference purposes, in the event that these divisions have to conduct additional investigations in this matter.

b7C
OS
MAHEU, during his stay at the Kenilworth Hotel, Bal Harbour, Florida, during the latter part of October, 1960, telephonically contacted the residence of [redacted]

Since there is no apparent connection between [redacted] and this investigation, no attempt was made to interview her in this matter.

B.*
COVER PAGE

UNITED STATES DEPARTMENT OF JUSTICE
FEDERAL BUREAU OF INVESTIGATION

Copy to: 1 - USA, LAS VEGAS

Report of: [REDACTED] b7c
Date: April 6, 1961

Office: MIAMI, FLORIDA

Field Office File No.: 139-63

Bureau File No.: 139-1201

Title: ARTHUR JAMES BALLETTI;
UNKNOWN SUBJECT, also known as
J. W. Harrison

Character: UNAUTHORIZED PUBLICATION AND USE OF COMMUNICATIONS

Synopsis: EDWARD L. DUBOIS, JR., reinterviewed 3/20/61, and claims ROBERT MAHEU paid his agency a fee of \$1,000.00 in cash. DUBOIS states MAHEU phoned BALLETTI at Las Vegas and instructed him to contact T. W. RICHARDSON at the New Frontier Hotel, Las Vegas. BALLETTI followed instructions and RICHARDSON gave him \$1,000.00 in cash. DUBOIS denies ownership of any equipment seized at time of BALLETTI's arrest, except he owns Minefon tape recorder, Minox camera and .35 mm Contessa camera and film. Denies any knowledge of other equipment. BALLETTI reinterviewed 3/29/61. Admits receiving \$1,000.00 in cash from T. W. RICHARDSON in Las Vegas on 10/31/60. BALLETTI admits taking Minefon and 2 cameras with him to Las Vegas. Denies any knowledge of other technical equipment seized. Claims he can furnish no additional information regarding arrest. No record on JOHN A. ROLLINS, Miami.

- RUC -

DETAILS:

Date April 4, 1961

ARTHUR JAMES BALLETTI was interviewed by
Special Agents [REDACTED] and [REDACTED]
at Miami. b7c

At the outset of the interview, BALLETTI was advised that he did not have to make a statement, and any statement he made could be used against him in a court of law. BALLETTI was advised of his rights to an attorney.

BALLETTI was questioned as to what equipment he took from Miami to Las Vegas in the latter part of October, 1960. BALLETTI stated that he took a Minefon tape recorder and a small green bag, which contained a microphone for the recorder and an ear piece for the recorder. He also took a .35 mm Zeiss Contessa camera, and a Minox camera, along with tape for the recorder and film for the camera. BALLETTI stated that he has no idea who owns the other technical equipment which was confiscated in the hotel room at the time of his arrest. BALLETTI admitted that he and HARRISON checked in together at the Riviera Hotel. However, BALLETTI would not definitely state that this equipment was brought into the hotel by HARRISON.

BALLETTI added that he does not recall telling the officers who arrested him at Las Vegas that J. W. HARRISON was actually FRED HARRIS of Miami. BALLETTI stated that he is at a loss to explain how the officers came by this information.

BALLETTI stated that he has no information as to how HARRISON departed Las Vegas, and does not know what airplane tickets, if any, HARRISON used. BALLETTI stated that he no longer can recall whether HARRISON left the day before he, BALLETTI, was arrested, or on the morning of the day on which he was arrested.

2.

On 3/29/61 at Miami, Florida File # Miami 139-63

b7c
by Special Agent [REDACTED] and [REDACTED] Date dictated 3/29/61
[REDACTED] neb

MM 139-63

BALLETTI stated that either on October 30 or October 31, 1960, that he received a long distance telephone call from ROBERT MAHEU. BALLETTI stated that he never knew where MAHEU was making the call from. MAHEU instructed him to contact T. W. RICHARDSON at the New Frontier Hotel, Las Vegas, and that RICHARDSON would pay him a \$1,000.00 fee. BALLETTI continued that he took a taxi from the Riviera Hotel to the New Frontier Hotel, only to find that the hotels were only a very short distance apart. BALLETTI stated that he went into the hotel and asked probably a bellboy where he could locate T. W. RICHARDSON, and the bellboy referred him to the pit (card room) at the hotel. BALLETTI stated that he went to the pit and asked one of the guards how he could contact T. W. RICHARDSON, and the guard had him wait at one of the tables, which was not being used. A short time later, RICHARDSON came over to the table, and BALLETTI gave him the password, which he recalled was "MOKO sent me." RICHARDSON indicated that BALLETTI should follow him, and they walked out of the card room into the men's room, where RICHARDSON gave him ten \$100.00 bills. BALLETTI stated that he gave RICHARDSON no receipt for the money, and he put the money in his pocket, and left the hotel.

BALLETTI described RICHARDSON as follows:

Race:	White
Sex:	Male
Nationality:	American
Age:	Late 40's
Height:	6' 1"
Weight:	190 lbs.
Build:	Medium
Hair:	Dark, steel gray at temples
Characteristics:	Did not wear glasses or have a mustache, or any other distinguishing facial features

MM 139-63

Clothing:

Claims RICHARDSON was wearing a dark suit, white shirt, and tie

BALLETTI stated that based on his conversation with the bellboy and the guard in the card room, and watching RICHARDSON work around the hotel, he believed that RICHARDSON was well known at the hotel and possibly could be connected with the ownership or management of the hotel and gambling casino.

BALLETTI was again asked if he did not actually know the true identity of J. W. HARRISON. BALLETTI denied this, and reiterated that he has furnished all the information that he has concerning HARRISON. BALLETTI also denied having any connection with the wire tap found on DAN ROWAN's phone.

BALLETTI added that he now has furnished all the information in his possession to the FBI.

Date March 22, 1961

b7C
On March 20, 1961, EDWARD L. DU BOIS, JR. was interviewed by SAS [REDACTED] and [REDACTED]. At the outset of the interview, DU BOIS was advised that he did not have to make a statement; that if he did make a statement it could be used against him in a court of law; and that he had the right to consult an attorney.

DU BOIS stated he wished to cooperate to the fullest extent with the Federal Bureau of Investigation in this investigation and was willing to make available any record or information which he had in his possession.

After reviewing his records, DU BOIS stated that on October 25, 1960, his company, Investigations, Inc., purchased two round trip tickets from Miami, Florida, to Los Angeles, California, and return. American Express billed the company \$700.88 for the costs of these tickets. The credit card used bore the name ARTHUR J. BALLETTI, #016 043 789 3, which was issued to BALLETTI by Investigations, Inc. Among DU BOIS' records was the receipt portion of American Airlines Ticket, #1,771,944, bearing the name R. HUNTER and issued on October 25, 1960. The return portion of this ticket reflects that on November 3, 1960, American Airlines issued a ticket to R. HUNTER from Los Angeles to Ft. Worth, New Orleans and Miami in exchange for ticket #529927 issued October 25, 1960, at Miami. DU BOIS' records did not contain the return stub of the ticket bearing the name J. W. HARRISON.

DU BOIS continued that ROBERT MAHEU paid him \$1,000.00 in cash as his Retainer. DU BOIS claims that BALLETTI told him that on October 31, 1960, he, BALLETTI, received a long distance telephone call from MAHEU who claimed that he was calling from Los Angeles. MAHEU instructed BALLETTI to go either to the Dunes or Flamingo Hotels in Las Vegas and contact a Mr. RICHARDSON and that RICHARDSON would pay him the Retainer. DU BOIS continued that BALLETTI went to one of the two above mentioned hotels

5.

On 3/20/61 at Miami, Florida File # MIAMI 139-63

by SAS [REDACTED] and [REDACTED] Date dictated 3/20/61
[REDACTED] pam

MM 139-63

contacted Mr. RICHARDSON and RICHARDSON did in fact pay him \$1,000.00 in cash. DU BOIS claims that it was BALLETTI's impression that RICHARDSON was probably MAHEU's client and that probably RICHARDSON was either the owner or connected with the management of the hotel where he was contacted.

DU BOIS was asked if he knew JOHN A. ROLLINS and he stated that he did not know anyone by that name.

DU BOIS was questioned concerning the equipment found in Room 331 of the Riviera Hotel, Las Vegas, Nevada, at the time ARTHUR JAMES BALLETTI was arrested. DU BOIS stated the Minifon Tape Recorder found in the room belonged to his agency along with the Minox Camera and the .35 mm Zeiss camera as well as the film that belonged to these two cameras. DU BOIS denied that any of the other technical equipment found in the room belonged to his agency. DU BOIS stated that he does not know who owned this equipment but assumed it belonged to J. W. HARRISON.

DU BOIS was questioned as to why BALLETTI took the Minifon with him on this assignment, to which DU BOIS replied that the Minifon and the cameras were standard equipment with his operators.

DU BOIS added that Attorney THOMAS FOLEY, whom he understands is the brother of the Attorney General for the State of Nevada, was hired to defend BALLETTI at Las Vegas. DU BOIS stated that FOLEY was hired by Attorney JAMES F. CANTILLION of Beverly Hills, California, whom he understands is an attorney of ROBERT MAHEU's. DU BOIS stated that it is his understanding that MAHEU is paying the attorney's fees.

DU BOIS reiterated that he does not know the name of the principal in this case who contacted MAHEU to have the surveillance instituted on DAN ROWAN. DU BOIS added that he does not know nor can he furnish any additional information on J. W. HARRISON other than this individual was reported to be an employee of MAHEU and sent by MAHEU to Las Vegas to aid on the surveillance of ROWAN.

Date March 27, 1961

EDWARD L. DUBOIS, Jr., telephonically advised that he found in his records a slip of paper, which reflects that "T. W. RICHARDSON, New Frontier Hotel, DU 2-7171, Las Vegas," was the name used by the individual who paid BALLETTI \$1,000.00 in cash at Las Vegas.

7.

On 3/21/61 at Miami, Florida File # Miami 139-63
b7c

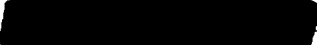
by Special Agent  neb Date dictated 3/22/61

This document contains neither recommendations nor conclusions of the FBI. It is the property of the FBI and is loaned to your agency; it and its contents are not to be distributed outside your agency.

Date March 22, 1961

Records of the Southern Bell Telephone and Telegraph Company, 300 Northeast 3rd Avenue, Ft. Lauderdale, Florida, reflect that LO 4-8511 was listed during October, 1960, and is currently listed to the Escape Hotel, 2900 Rio Mar Drive, Ft. Lauderdale. This is the hotel switchboard number.

JA 3-1441 during October, 1960, was assigned to the switchboard at the Broward County Circuit Court Offices, Court House, Ft. Lauderdale, Florida. This switchboard covers the offices of the Circuit Court Clerk, County Finance Department and Recording Department. This number has been changed to JA 5-2921.

In order to produce these records, a subpoena duces tecum must be directed to [REDACTED] Assistant Manager, Southern Bell Telephone and Telegraph Company, 300 Northeast 3rd Avenue, Ft. Lauderdale, Florida. b7c

8.

On 3/3/61 at Ft. Lauderdale, Florida File # MIAMI 139-63
by SA [REDACTED] bam Date dictated 3/3/61

March 22, 1961

Date _____

b7C
b7D
OS

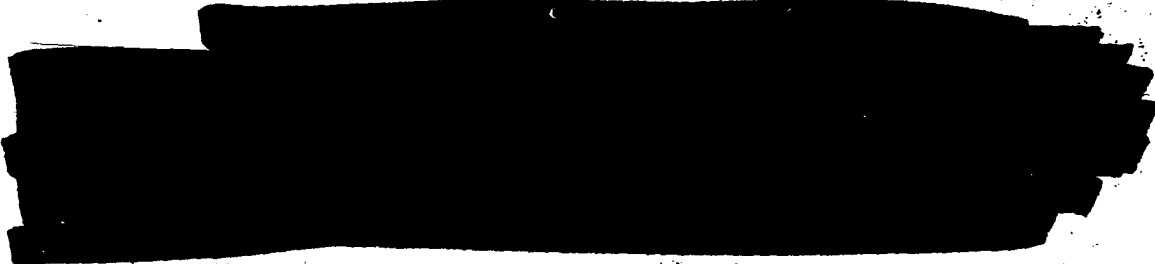

9.

On 3/3/61 at Hollywood, Florida File # MIAMI 139-63

by SA [redacted] :bam b7C Date dictated 3/3/61

This document contains neither recommendations nor conclusions of the FBI. It is the property of the FBI and is loaned to your agency; it and its contents are not to be distributed outside your agency.

MM 139-63
DJO:bam

b7C

b7D

Q5



MM 139-63

b7c
On March 24, 1961, Investigative Clerk [REDACTED] reviewed the records of the Dade County Department of Public Safety, Miami Police Department, the Miami Beach Police Department, Credit Bureau of Greater Miami, and the Municipal Court of Miami, and was unable to locate any information identifiable with JOHN A. ROLLINS.

FEDERAL BUREAU OF INVESTIGATION

Reporting Office LAS VEGAS	Office of Origin LAS VEGAS	Date 4/11/61	Investigative Period 2/15 - 4/6/61
TITLE OF CASE ARTHUR JAMES BALLETTI; UNSUB, aka J. W. Harrison		Report made by [REDACTED] b7C	Typed By: hsl
		CHARACTER OF CASE UPUC	

~~SECRET~~

REFERENCE: Report of SA [REDACTED] dated 2/8/61 at Salt Lake City. **b7C**

Report of SA [REDACTED] dated 3/6/61 at Los Angeles. **b7C**

Miami airtel to Las Vegas dated 3/21/61.

Los Angeles airtel to Phoenix dated 3/30/61.

- P -

ADMINISTRATIVE:

Bureau has instructed investigation in this matter be handled expeditiously.

Approved <i>[Signature]</i>	Special Agent In Charge	Do not write in spaces below		
Copies made: (2 - Bureau (139-201) 1 - USA, Reno 1 - Chicago (139-105) (Info) 1 - Los Angeles (139-77) (Info) 1 - Washington Field (139-61) (Info) 1 - Phoenix (Info) 1 - Miami (139-63) (Info) 2 - Las Vegas (139-1)		139-1201-	35	REC-9
		APR 13 1961		
		STAT. SECT.		

Rec'd: Criminal Division
Form C-94 (6) 4-18-61

C-94 APP 01 1961

LV 139-1

LEADS

Copies are being furnished Los Angeles, Miami, and Phoenix for information in view of investigation being conducted by those divisions.

Copies are being furnished Chicago for information since Chicago may be requested to conduct investigation in the future and also Chicago is Office of Origin in case entitled, "SAMUEL M. GIANCANA, aka. AR".

- B* -
COVER PAGE

UNITED STATES DEPARTMENT OF JUSTICE
FEDERAL BUREAU OF INVESTIGATION

Copy to: 1 - USA, Reno
b7c

Report of: [REDACTED] hsl Office: Las Vegas, Nevada
Date: 4/11/61

Field Office File No.: 139-1 Bureau File No.: 139-1201

Title: ARTHUR JAMES BALLETTI;
UNKNOWN SUBJECT, also
known as J. W. Harrison

Character: UNAUTHORIZED PUBLICATION AND USE
OF COMMUNICATIONS

Synopsis:

Subject BALLETTI claims \$1,000 was paid to him while in Las Vegas by one T. W. RICHARDSON. Registration card bearing name, J. W. HARRISON, forwarded to Laboratory.

- P -

DETAILS:

By communication dated February 13, 1961, the Washington Field Office advised that ROBERT MAHEU, Maheu and King Associates, Incorporated, 1125 - 19th Street, Northwest, Washington, D.C., informed that he had just returned from California and that after talking to the Los Angeles attorney who had originally requested him to contact EDWARD DUBOIS, had been unable to secure permission from this attorney to divulge the attorney's name to the FBI. The Los Angeles attorney had advised MAHEU that he did not desire to become involved in this matter.

MAHEU further advised that it was now his recollection that WALTER FITZPATRICK, an associate of MAHEU, had actually originally contacted DUBOIS. MAHEU emphatically denied that he or FITZPATRICK had contacted DUBOIS requesting only one man to be sent to Las Vegas.

LV 139-1

MAHEU identified J. A. ROLLINS as one JOHN A. ROLLINS. MAHEU would not identify ROLLINS further as to ROLLINS being an employee of MAHEU's, stating ROLLINS was working indirectly for MAHEU in Miami. MAHEU denied that ROLLINS was the individual who went to Las Vegas with subject BALLETTI stating that the Kenilworth Hotel records in Miami Beach would reflect that ROLLINS was there during the period BALLETTI was in Las Vegas.

By communication dated March 20, 1961, the Miami Division advised that EDWARD L. DUBOIS, JR., claims that MAHEU, while in Los Angeles on October 31, 1960, telephonically contacted BALLETTI at Las Vegas and instructed him to go either to the Dunes or the Flamingo Hotel and contact a Mr. RICHARDSON and that RICHARDSON would pay BALLETTI \$1,000 in cash. BALLETTI told the boys that RICHARDSON was allegedly well known at the hotel and might be either the owner or manager.

The list of equipment confiscated at the time of BALLETTI's arrest, was reviewed with DUBOIS. DUBOIS admits owning the Minox camera, 35 m.m. minifon camera, and the minifon tape recorder. DUBOIS claims this equipment is standard with his operators in a case.

By communication dated March 21, 1961, the Miami Division advised that EDWARD L. DUBOIS, JR., had informed that he had located information which reflected that T. W. RICHARDSON, New Frontier Hotel, Las Vegas, was the one who paid the \$1,000 in cash to BALLETTI.

Date March 28, 1961

b7c

[REDACTED] Riviera Hotel, furnished the two following hotel registration cards:

1. Card No. 192583, bearing name ARTHUR J. BALLETTI.
2. Card No. 192650, bearing name J. W. HARRISON.

- 3 -

On 3/28/61 at Las Vegas, Nevada File # Las Vegas 139-1
by S. [REDACTED] hsl Date dictated 3/28/61

This document contains neither recommendations nor conclusions of the FBI. It is the property of the FBI and is loaned to your agency; it and its contents are not to be distributed outside your agency.

LV 139-1

By communication dated March 28, 1961, Riviera Hotel Registration Card Number 192650, which contained the handwriting of unknown subject, also known as J. W. HARRISON was submitted to the FBI Laboratory to be compared with the handwriting on the registration card from the Kenilworth Hotel, Miami Beach, which bears the name of J. A. ROLLINS.

By communication dated March 22, 1961, the Miami Division submitted registration card from the Kenilworth Hotel, Miami Beach, which contained the name J. A. ROLLINS, 1125 - 19th Street, Northwest, Washington, D.C.

By communication dated March 28, 1961, the Los Angeles Division advised that efforts to locate ROBERT MAHEU in Beverly Hills, California for interview, was unsuccessful in that MAHEU had left the Los Angeles area.

By communication dated March 29, 1961, the Miami Division advised that BALLETTI was reinterviewed on March 29, 1961, and denied any knowledge of equipment confiscated at the time of his arrest except the minifon recorder, 35 m.m. camera, and Minox camera, which he claimed he carried to Las Vegas.

BALLETTI again claimed he had no knowledge of unknown subject, also known as J. W. HARRISON's true identity.

By communication dated March 30, 1961, the Los Angeles Division advised that information was developed that ROBERT MAHEU was in Tucson, Arizona and could be reached at telephone number East 5-2294.

Intensive investigation was conducted in the Las Vegas area to locate T. W. RICHARDSON. [REDACTED]

b7c
b7D [REDACTED] advised on April 6, 1961 that T. W. RICHARDSON is now associated with the Riverside Hotel in Reno, Nevada and could be located there at any time.

FEDERAL BUREAU OF INVESTIGATION

REPORTING OFFICE LOS ANGELES	OFFICE OF ORIGIN LOS ANGELES LAS VEGAS	DATE 4/12/61	INVESTIGATIVE PERIOD 3/20 - 4/7/61
TITLE OF CASE ARTHUR JAMES BALLETTI; UNKNOWN SUBJECT, aka J.W. Harrison		REPORT MADE BY [REDACTED] b7c	TYPED BY ism
		CHARACTER OF CASE UPUC	

REFERENCES

b7c Report of SA [REDACTED] dated 2/14/61 at Miami.

b7c Report of SA [REDACTED] dated 3/6/61 at Los Angeles.

Los Angeles airtel tp Phoenix dated 3/30/61.

Los Angeles airtel to Washington Field dated 3/28/61.

Las Vegas airtel to Los Angeles dated 3/17/61.

-P-

ADMINISTRATIVE

Copies of this report are being furnished Chicago, Miami, and Washington Field offices for information inasmuch as they have outstanding investigation in this matter.

b7c With reference to the telephone toll calls charged to J.A. ROLLINS at the Kenilworth Hotel, Miami Beach, Florida, in October, 1960, as set out in referenced report of SA [REDACTED] it is noted that two of the calls were to telephone [REDACTED].

APPROVED <i>[Signature]</i>	SPECIAL AGENT IN CHARGE
COPIES MADE:	
2-Bureau (139-1201) 1-Chicago (Info) 3-Las Vegas (139-1) (1-USA, Las Vegas) 1-Miami (Info) (139-63) 1-WFO (139-61) (Info) 2-Los Angeles (139-77)	
Dissemination Record of Attached Report	
Agency	
Request Recd.	
Date Fwd.	
How Fwd.	
By	

DO NOT WRITE IN SPACES BELOW
139 1201 [Handwritten] REG-41 20 APR 27 1961 [Handwritten signatures and initials]
Notations

50 APR 27 1961

LA 139-77

number WH 3-1155 in Chicago, which is the telephone number of [REDACTED] one of the calls was to the telephone number of [REDACTED] California, and one was to the Desert Inn Hotel in Las Vegas, Nevada.

Both [REDACTED] are close friends of JOHN ROSELLI, aka, who is currently under investigation by the Los Angeles Office as a top hoodlum in the case entitled, "JOHN ROSELLI, aka AR". JOHN ROSELLI receives many telephone calls at the Desert Inn Hotel in Las Vegas. From the above facts, it would appear possible that ROLLINS was trying to contact JOHN ROSELLI in October, 1960. As set out in the attached report, [REDACTED]

[REDACTED] Florida, during October, 1960. Neither [REDACTED] are acquainted with a JOHN A. ROLLINS. The [REDACTED] had no house guests at that time. The person calling the [REDACTED] telephone number could have asked for ROSELLI and as he was not at the [REDACTED] residence then the person answering the telephone at the [REDACTED] residence might not have been advised that the call was from Florida.

ROSELLI left Los Angeles for Las Vegas, Nevada on September 15, 1960, via Western Airlines and is not known to have been in Los Angeles again until November 14, 1960. On [REDACTED]

Las Vegas, Nevada, furnished information that he had not observed ROSELLI in or around the Diplomat Apartments for the past two or three weeks. His telephone at the Diplomat Apartments was disconnected on 10/20/60 for non payment of the bill. It has since been reinstalled.

[REDACTED]

The request to interview DON ROWAN, [REDACTED] Los Angeles, California, to determine specifically if SAM GIANCANA had any connection with the wire tapping case

LA 139-77

is set out in Chicago airtel to Las Vegas dated 3/16/61 in the case entitled "SAMUEL M. GIANCANA, aka, AR".

b7C WFO airtel to Chicago dated 3/22/61 contains a request to interview ROBERT MAHEU who reportedly was to be at 1510 Gilcrest Drive, Beverly Hills, California, for a week commencing about March 22, 1961. On 3/28/61, [REDACTED] an associate of ROBERT MAHEU, 1510 Gilcrest Drive, Beverly Hills, California, advised that MAHEU had left the Los Angeles area on a trip to the East Coast and would probably be in touch with his office in Washington, D.C. Referenced airtel was sent to the Washington Field Office on 3/28/61 requesting them to locate MAHEU for interview.

b7C On March 30, 1961, [REDACTED] telephonically advised SA [REDACTED] that as of that date, MAHEU was in Tucson, Arizona, and could be reached at telephone number East 5-2294.

Referenced airtel dated 3/30/61 was sent to Phoenix. The Phoenix Office was furnished with a summary of information in this case and requested to conduct an interview of MAHEU.

The current telephone directories for the Los Angeles area reflect that the law firm of Cantillon and Cantillon, 9441 Wilshire Boulevard, Beverly Hills, California, have two telephone numbers, namely, CR 6-6885 and BR 2-4386. In addition, the residence telephone number of JAMES CANTILLON at 814 Camden Drive, Beverly Hills, California, is CRestview 5-5878. A request has been made by the Los Angeles Office of the Pacific Telephone Company to obtain the toll calls charged to the above three numbers in October, 1960, to determine whether or not any calls were made to Washington, D.C.

b7C It has been previously reported in this investigation that on 10/25/60 the hotel room of ROBERT MAHEU, Kenilworth Hotel, Miami Beach, Florida, was charged with a telephone toll call to telephone number [REDACTED] in Los Angeles, and that this number was an unpublished number listed to [REDACTED]

LA 139-77

California.

[REDACTED]

[REDACTED]

[REDACTED]

[REDACTED]

b7C
b7D
OS

As of April 7, 1961 [REDACTED] had not contacted the Los Angeles Office.

[REDACTED] further stated that for about 1½ to 2 years prior to selling the residence at [REDACTED] in November, 1960, it had been rented to a [REDACTED] who was a uniformed officer of the Los Angeles Police Department.

[REDACTED] stated that they have no telephone at [REDACTED]

[REDACTED]

LA 139-77

[REDACTED]

b7C
OS

On 4/5/61 SE [REDACTED] ascertained that the records of the Retail Merchants Credit Association contained no record identifiable with [REDACTED]

LEADS

LOS ANGELES

AT LOS ANGELES, CALIFORNIA: (1) Will report the results of a review of telephone toll calls charged to the law offices of Cantillon and Cantillon and to the residence of JAMES CANTILLON, to determine if any calls were made to Washington, D.C. during October, 1960.

b7C (2) Upon receipt from the General Telephone Company of the identity of the subscriber to telephone number [REDACTED] will conduct investigation to identify this individual and consider interviewing him concerning instant case.

UNITED STATES DEPARTMENT OF JUSTICE
FEDERAL BUREAU OF INVESTIGATION

Copy to:

1-USA, Las Vegas.

Report of:

b7c

[REDACTED]

ism

Office: Los Angeles, California

Date:

4/12/61

Field Office File #:

139-77

Bureau File #:

139-1201

Title:

ARTHUR JAMES BALLETTI;
UNKNOWN SUBJECT

Character:

UNAUTHORIZED PUBLICATION OR USE OF COMMUNICATIONS

Synopsis:

ROBERT MAHEU reported to be in Tucson, Arizona, during first part of April, 1960. Attorneys JAMES J. ARDITTO, Los Angeles, California, and GREGSON BAUTZER, Beverly Hills, California, to whom telephone toll calls were charged to MAHEU's hotel room at Kenilworth Hotel, Miami Beach, Florida, in October, 1960, stated they were acquainted with MAHEU but both deny any participation in or knowledge of a wire tap on DAN ROWAN's telephone. DAN ROWAN on reinterview stated that he has never met SAMUEL GIANCANA and never knew of him until an officer of Clark County Sheriff's Office mentioned the name to him in latter part of October, 1960; that he has no information that GIANCANA is connected with instant wire tap, and that PHYLLIS MC GUIRE, who ROWAN plans to marry, knew of no suspects in this case. [REDACTED] was in New York City during October, 1960, and neither he nor his wife could furnish any information concerning a long distance telephone call from Florida during latter part of October, 1960.

b7c

-P-

LA 139-77

DETAILS:

ROBERT MAHEU
1510 Gilcrest Drive
Beverly Hills, California

On March 28, 1961, [REDACTED] an associate of ROBERT MAHEU, 1510 Gilcrest Drive, Beverly Hills, California, telephone number CR 1-8770, advised that MAHEU left the Los Angeles area on a trip to the East Coast and that he does not know MAHEU's itinerary, but MAHEU would undoubtedly be in contact with his office in Washington, D.C.

On March 30, 1961, [REDACTED] telephonically furnished information that he had learned that MAHEU was then residing in Tucson, Arizona, and could be reached through telephone number East 5-2294. The Phoenix Office was advised of the latter information on March 30, 1961, and requested to interview MAHEU at Tucson, Arizona.

JAMES J. ARDITTO
Attorney at Law
727 West 7th Street
Los Angeles, California

Information has been previously reported in this investigation that on October 22 and 28, 1960, the room rented by ROBERT MAHEU at the Kenilworth Hotel, Miami Beach, Florida, was charged with a telephone toll call to telephone number [REDACTED] which was listed to JAMES J. ARDITTO, [REDACTED] Senda Lane, Flintridge, California.

The current telephone directories for Los Angeles show that JAMES J. ARDITTO maintains a law office at [REDACTED] Street, Los Angeles, California, and has telephone number [REDACTED]. It is noted that a telephone toll call was charged to MAHEU's room at the Kenilworth Hotel on October 21, 1960, to telephone number [REDACTED].

Date April 10, 1961

[REDACTED]

b7C
b7D
OS

The above information was furnished on a confidential basis and should not be discussed without a subpoena duces tecum to [REDACTED] attention

[REDACTED] Special Agent in Charge, [REDACTED] Los Angeles, California.

On 3/29/61 at Los Angeles, California File # Los Angeles 139-77
by SE [REDACTED] ism b7C Date dictated 4/4/61

LA 139-77

b7C
On April 3, 1961, JAMES J. ARDITTO was interviewed by SA's [REDACTED] and [REDACTED]. ARDITTO said that he had nothing to do with any type of investigation conducted in Las Vegas in October, 1960, and did not, at that time nor at any other time, have any connection with a case involving the placing of a telephone tap.

ARDITTO said that he is acquainted with ROBERT MAHEU. He said that he, ARDITTO, has done work for HOWARD HUGHES and various firms connected with HOWARD HUGHES and became acquainted with MAHEU through this work, inasmuch as MAHEU conducts investigations for HOWARD HUGHES.

ARDITTO recalled that he last saw MAHEU on December 23, 1960, at the Beverly Wilshire Hotel in Beverly Hills, at which time MAHEU was accompanied by GREG BAUTZER. Prior to that, he saw MAHEU in about the middle of October, 1960, or about three weeks prior to the national election in Los Angeles. Both of these meetings were in connection with business interests of HOWARD HUGHES and in no way concerned an investigation in Las Vegas, Nevada. ARDITTO said he has no knowledge of any investigation conducted in Las Vegas, Nevada in October, 1960, by either EDWARD DU BOIS or ROBERT MAHEU.

ARDITTO said he stopped working for the Howard Hughes Organization on December 24, 1960, when he filed a suit on his own behalf against HUGHES.

ARDITTO said that he does not know and has never heard of SAMUEL GIANCANA. ARDITTO said that GREG BAUTZER currently does law work for HOWARD HUGHES.

GREGSON BAUTZER
190 North Canon Drive
Beverly Hills, California

Information has been set out previously in this investigation that on October 12, 24, 28, 1960, the room rented by ROBERT MAHEU at the Kenilworth Hotel, Miami Beach, Florida, was charged with telephone toll calls to telephone number

LA 139-77

CR 5-5121, which is listed to the law firm of Bautzer and Grant, 190 North Canon Drive, Beverly Hills, California.

b7c On April 4, 1961, GREGSON BAUTZER was interviewed at his office by SA [REDACTED] and [REDACTED] and stated that he is well acquainted with ROBERT MAHEU. He said he is aware of the fact that MAHEU spends some time in Florida, but it is not in connection with anything in which BAUTZER is also interested and he added that he does not know the nature of MAHEU's work in Florida.

BAUTZER said that he has no client who requested an investigation be conducted in Las Vegas in October, 1960; that no other person requested him to make arrangements for such an investigation; that he has no knowledge of the fact that a wire tap had been placed on the telephone of DAN ROWAN in Las Vegas, Nevada, and that he is not acquainted with SAM GIANCANA.

BAUTZER stated that he is an acquaintance of DAN ROWAN.

The current telephone directory for Beverly Hills reflects that the law firm of Bautzer and Grant also has telephone number BR 2-6535.

April 10, 1961

[REDACTED]

[REDACTED]

[REDACTED]

[REDACTED] furnished on a confidential basis [REDACTED]

[REDACTED]

b7c
b7D
OS

On 3/30/61 at Los Angeles, California File # Los Angeles 139-77
 by SE [REDACTED] ism Date dictated 4/5/61
b7c

LA 139-77

It is noted that information has been previously reported in this investigation that during the month of October, from the period of October 11 to 29, 1960, the hotel room of ROBERT MAHEU at the Kenilworth Hotel, Miami Beach, Florida, was charged on nearly a daily basis for calls made to telephone number JE 3-7277, Washington, D.C.

b7C DAN ROWAN

Los Angeles, California

On March 30, 1961, Mr. RALPH PLANT, Braunstein, Chernin and Plant, 449 South Beverly Drive, Beverly Hills, California, advised that this firm is the agent for DAN ROWAN and that ROWAN was then in Montreal, Canada, but was scheduled to return to Beverly Hills in the near future and that he would have ROWAN contact the Los Angeles Office upon his return.

b7C On April 5, 1961, DAN ROWAN telephonically contacted SA [REDACTED] at which time he advised that he did not believe he had any information of pertinence to add to this investigation and that due to a heavy schedule, he did not see how he could arrange for a personal interview.

b7C He advised that he first heard of SAM GIANCANA from [REDACTED] of the Clark County Sheriff's Office in Las Vegas, Nevada, in the latter part of October, 1960, after the wire tap had been found in his room. He said that he has never met GIANCANA.

He has discussed SAM GIANCANA on one or two occasions with PHYLLIS MC GUIRE, who he stated he plans to marry. He said she was hesitant to discuss GIANCANA and stated that her relationship with GIANCANA took place long ago, no longer existed, and she saw no reason to discuss it. She said that GIANCANA still sends her gifts and flowers, but that this is entirely GIANCANA's idea and she has nothing to do with him. ROWAN said that PHYLLIS MC GUIRE could name no one who she suspected of having installed the wire tap.

LA 139-77

ROWAN said that he has no information concerning GIANCANA indicating that GIANCANA has any connection with the wire tap.

b7C He related that a Las Vegas newspaper carried an article concerning this matter, and his former wife, PHYLLIS ROWAN, [redacted] North Hollywood, California, telephone [redacted] called him in Las Vegas and said she had read about the finding of the wire tap and wanted to know about the matter. He said on this occasion he jokingly told his ex-wife that someone had suggested that she might have had the wire tap placed. to which she replied, "I couldn't care less what you do".

ROWAN said that he does not believe his wife had anything to do with the wire tap; [redacted]

b7C [redacted]
ROWAN stated that should he obtain any information in the future which would have a bearing on this case, he would advise the FBI.

b7C [redacted] California
Telephone [redacted]

b7C It has previously been reported in this investigation that on October 27, 1960, Room Number 701, Kenilworth Hotel, Miami Beach, Florida, which was rented by a J.A. ROLLINS, was charged with a toll call to telephone number [redacted] Los Angeles, California, and that this telephone number is listed to [redacted] California.

b7C On March 29, 1961, [redacted] was interviewed at his residence by SA's [redacted] and [redacted]

LA 139-77

He said he is not acquainted with a JOHN A. ROLLINS, that he knows of ROBERT MAHEU but does not know him personally, and that he does not recall any telephone call received from Florida during October, 1960. He then recalled that all during the month of October, 1960, he was in New York City

b7C

b7C

██████████ stated that she has no recollection of having received a long distance telephone call from Florida during October, 1960, that she is not acquainted with JOHN A. ROLLINS, and to the best of her recollection she had no house guest during October, 1960.

b7C

██████████ advised that he has never requested either ROBERT MAHEU or EDWARD DU BOIS to conduct any investigation in Las Vegas, Nevada.

FBI

Date: 4/18/61

Transmit the following in P
(Type in plain text or code)

Via AIR TEL AIR MAIL URGENT
(Priority or Method of Mailing)

TO: DIRECTOR, FBI (139-1201)

FROM: SAC, LOS ANGELES (139-77)

ARTHUR JAMES BALLETTI;
UNKNOWN SUBJECT, aka
J.W. Harrison;
UPUC.
OO: LAS VEGAS

4/12/61. Rerep SA [REDACTED] Los Angeles,

Rerep carries OO as Los Angeles. Please correct your copies of this report to reflect LAS VEGAS as Office of Origin.

Other offices receiving copies of rerep, please correct your copies to reflect LAS VEGAS as OO.

Los Angeles copies have been corrected.

3-Bureau
1-Chicago
1-Las Vegas (139-1)
1-Miami (139-63)
1-WFO (139-61)
1-Los Angeles
WGC:MCR
(8)

139-1201-

NOT RECORDED

3 APR 20 1961

Approved: Wess Sent _____ M Per _____
Special Agent in Charge

MAY 1 1961

SLA
CO-SOLIDARITY

FBI

Date: 4/24/61

Transmit the following in PLAIN TEXT
(Type in plain text or code)

Via AIRTEL AIR MAIL
(Priority or Method of Mailing)

TO: DIRECTOR, FBI (139-1201)
FROM: SAC, LAS VEGAS (139-1)
RE: ARTHUR JAMES BALLETTI; et al
UPUC
(OO: Las Vegas)

Re Washington Field Office airtel, dated 4/20/61.

Bureau is requested to advise Las Vegas and interested offices result of contact with CIA in this matter, if such contact is made.

In view of inference made by ROBERT MAHEU relative to possibility that instant investigation may have jeopardized work he was doing, Las Vegas is uncertain as to whether to press investigation pending advice as to whether investigation might interfere with a CIA matter.

F

- 3 - Bureau (RM)
- 1 - Chicago (139-105) (Info) (RM)
- 1 - Los Angeles (139-77) (Info) (RM)
- 1 - Miami (139-63) (Info) (RM)
- 2 - Las Vegas

MHP/bsj
(8)

REC-93 : 139-1201-

EX-105

5-1
8 APR 27 1961

*Airtel to [unclear]
4-28-61
JAC: acs*

CC - Wick

Approved: _____ Sent _____ M Per _____
Special Agent in Charge

4/28/61

airtel
AIRTEL

To: SAC, Las Vegas (139-1)
EX-105 REC-93
From: Director, FBI (139-1201) - 37

ARTHUR JAMES BALLETTI, et al.
UPUC
OO: Las Vegas

ReLVairtel 4/24/61, copies of which were furnished to offices receiving information copies of this airtel.

The Bureau is contacting CIA regarding this matter and you will be advised as to any information developed.

- 1 - Chicago (139-105) (Info)
- 1 - Los Angeles (139-77) (Info)
- 1 - Miami (139-63) (Info)

JAC: aeo *aed*
(7) *JAC*

MAILED 8
APR 29 1961
COMM-FBI

- Tolson _____
- Parsons _____
- Mohr _____
- Belmont _____
- Callahan _____
- Conrad _____
- DeLoach _____
- Evans _____
- Malone _____
- Rosen _____
- Tavel _____
- Trotter _____
- W.C. Sullivan _____
- Tele. Rm. _____
- Ingram _____
- Gandy _____

REC-105
MAY 4 1961

MAIL ROOM

TELETYPE UNIT

FEDERAL BUREAU OF INVESTIGATION

Reporting Office LAS VEGAS	Office of Origin LAS VEGAS	Date 5/22/61	Investigative Period 4/17 - 5/19/61
TITLE OF CASE ARTHUR JAMES ^OBALLETTI; UNKNOWN SUBJECT, aka J. W. Harrison		Report made by [REDACTED] b7c	Typed By hsl
		CHARACTER OF CASE UPUC	

Lep
~~XXXXXX~~

REFERENCE: Report of SA **[REDACTED]** dated 4/11/61 at Las Vegas.

Bureau airtel to Las Vegas dated 5/12/61.

- P -

ADMINISTRATIVE:

Bureau has instructed all offices to expedite investigation in this matter.

Information set forth in referenced Bureau airtel is not being placed in this report at this time since all offices have received copies of referenced Bureau airtel.

Approved <i>[Signature]</i>	Special Agent In Charge	Do not write in spaces below	
Copies made:		139-1201	REC-26
(2) - Bureau (139-1201) 1 - USA, Reno 1 - Chicago (139-105) (Info) 1 - Los Angeles (139-77) (Info) 1 - Washington Field (139-61) (Info) 1 - Miami (139-63) (Info) cf 2 - Las Vegas (139-1)		11 MAY 24 1961 WA 50755 SUB 11.21	2-11
cc: AAG Civil Rights Division Form 6-94 <i>B. J. M. / 1/11/3 / 3/29/61</i>		REC'D - CIVIL RIGHTS STANLEY	

LV 139-1

LEADS

One copy of this report is being furnished each office indicated for information purposes.

MIAMI

AT MIAMI, FLORIDA. During re-interview of EDWARD DU BOIS and BALLETTI, it should be noted that T. W. RICHARDSON Reno, Nevada, denied knowing BALLETTI and denied paying BALLETTI money as claimed.

- B* -
COVER PAGE

UNITED STATES DEPARTMENT OF JUSTICE
FEDERAL BUREAU OF INVESTIGATION

Copy to:

1 - USA, Reno
b7c

Report of:

[REDACTED] /hsl

Office: Las Vegas, Nevada

Date:

5/22/61

Field Office File No.:

139-1

Bureau File No.: 139-1201

Title:

ARTHUR JAMES BALLETTI;
UNKNOWN SUBJECT, also
known as J. W. Harrison

Character:

UNAUTHORIZED PUBLICATION AND USE
OF COMMUNICATIONS

Synopsis:

FBI Laboratory advised handwriting of unknown subject, also known as J. W. HARRISON not comparable with handwriting of J. ROLLINS. T. W. RICHARDSON denies knowing BALLETTI and denies paying any money to anyone. Local charges of BALLETTI dismissed at Las Vegas.

- P -

DETAILS:

By communication dated April 11, 1961, the FBI Laboratory advised that the handwriting on the Kenilworth Hotel, Miami Beach, Registration Card bearing the hand printed name of J. A. ROLLINS was not comparable with the handwriting on the Riviera Hotel, Las Vegas, Nevada Registration Card bearing the signature of J. W. HARRISON.

LV 139-1

AT RENO, NEVADA

On May 5, 1961, [REDACTED]

[REDACTED] made available to SA [REDACTED]
concerning TWYMAN WARNER RICHARDSON.

[REDACTED]

[REDACTED]

[REDACTED]

[REDACTED]

[REDACTED]

[REDACTED]

b7c
b7D

Four photographs of RICHARDSON were obtained. On May 5, 1961, SA [REDACTED] and [REDACTED] attempted to locate RICHARDSON at the Riverside Hotel; [REDACTED] advised that RICHARDSON was on a trip to Los Angeles and Las Las Vegas.

b7c

On May 11, 1961, [REDACTED] Nevada, advised SA [REDACTED] that a preliminary check failed to indicate that RICHARDSON is a stockholder in the Riverside Hotel.

b7c
b7D

Date 5/17/61

T. W. RICHARDSON was interviewed at the Riverside Hotel, which he said is his residence and where he said he can be located at any time.

He was informed that he did not have to make a statement, that he had a right to an attorney, and that any statement he did make could be used against him in court.

He denied knowing ARTHUR JAMES BALLETTI. He said he recalls from newspaper publicity at the time of the incident, the allegations that the telephone of DAN ROWAN was subject to surveillance. He denied having had any connection with the incident, and denied having paid any money to anyone in connection with the incident.

He was informed that the United States Attorney's Office might at a later date bring this matter before a Federal Grand Jury, and that if so he would be subject to subpoena. He said he had no objections to so appearing as he had nothing to hide.

He also advised that if he were placed in a group of men that he doubts that BALLETTI would be able to identify him unless he may have seen him in Las Vegas and know who RICHARDSON is just from common knowledge. He reiterated that he does not know BALLETTI or who BALLETTI is.

- 3 -

On 5/11/61 at Reno, Nevada File # Las Vegas 138-1
 by SA'S [REDACTED] and [REDACTED] dictated 5/11/61
 CC

This document contains neither recommendations nor conclusions of the FBI. It is the property of the FBI and is loaned to your agency; it and its contents are not to be distributed outside your agency.

LV 139-1

b7c [REDACTED] Records Bureau, Clark
County Sheriff's Office, advised on May 15, 1961, records of
that office reflect that the charges of ARTHUR JAMES BALLETTI
unauthorized intervention of privacy and operating as a pri-
vate detective without a license, were dismissed on April 24,
1961, inasmuch as the complaining witness did not desire to
prosecute.

FBI

Date: 4/20/61

Mr. Tolson	
Mr. Parsons	
Mr. Mohr	
Mr. Belmont	
Mr. Callahan	
Mr. Conrad	
Mr. DeLoach	
Mr. Evans	
Mr. Malone	
Mr. Rosen	
Mr. Tavel	
Mr. Trotter	
Mr. W.C. Sullivan	
Tele. Room	
Mr. Holloman	
Miss Gandy	

Transmit the following in _____
(Type in plain text or code)

Via AIRTEL _____
(Priority or Method of Mailing)

TO: DIRECTOR, FBI (139-1201)

FROM: SAC, WFO (139-61)

ARTHUR JAMES BALLETTI; et al.
UPUC
(OO: LV)

Handwritten signatures and initials

ReLVairtel to Director dated 3/21/61, captioned "SAMUEL N. GIANCANA, aka, AR," OO:CG. LAairtel to PX dated 3/30/61, interoffice. FXairtel to LV dated 4/11/61, inter-office.

Enclosed for the Bureau are four copies of a letterhead memorandum reflecting an interview with ROBERT MAHEU by SA [redacted] on 4/18/61. Enclosed for CG, LA, and MM is one copy each of this memorandum. Enclosed for LV are three copies of this memorandum, one of which is designated for the USA Reno.

MAHEU did not say that he was working with CIA but from his statements this insinuation was made. MAHEU stated that the facts could be verified by contacting Colonel SHEFFIELD EDWARDS, Director of Security, CIA, and that an analysis of his telephone calls, which he indicates had been checked by the FBI, could be ascertained that he had made numerous calls to EXECutive 3-6115 (telephone number for CIA). MAHEU stated that he was quite disturbed by instant investigation indicating that it could possibly have jeopardized the work that

RUC ENCLOSURE 4

- 3- Bureau (Enc. 4)
- 1- Chicago (139-105) (Enc. 1) (Info) (RM)
- 3- Las Vegas (139-1) (Enc. 3) (Info) (RM) (AM)
- 1- Los Angeles (139-77) (Enc. 1) (Info) (RM) (AM)
- 1- Miami (139-63) (Enc. 1) (Info) (RM) *one*
- 1- WFO

REC-24 139-1201 3

12 MAY 27 1961

*0-17 to WFO
4-21-61*

1 cc CIVIL RIGHTS UNIT

AIRTEL

CWB:ljd
(10)
Approved: _____
Special Agent in Charge

cc: AAG Civil Rights Division
Form 6-94 (2) 4-21-61 SAC: acc

Sent _____ M Per _____

57 MAY 31 1961

Handwritten number 6-10

WFO 139-61

he was doing. MAHEU volunteered very little information and was reluctant to furnish any detail concerning his activities.

The Bureau may desire, through contact with CIA, to ascertain MAHEU's activities with that organization and if possible, to secure further information regarding instant violation.



UNITED STATES DEPARTMENT OF JUSTICE
FEDERAL BUREAU OF INVESTIGATION

In Reply, Please Refer to
File No.

TOP SECRET

WASHINGTON 25, D. C.

April 20, 1961

ARTHUR JAMES BALLETTI; UNKNOWN SUBJECT;
ALSO KNOWN AS J. W. HARRISON
UNAUTHORIZED PUBLICATION AND USE OF COMMUNICATIONS

On April 18, 1961, Robert ~~Maheu~~, Maheu and King Associates, Incorporated, 1125 19th Street, N. W., Washington, D. C., advised a Special Agent of the FBI that with the recent invasion of Cuba by anti-Castro forces, he is now in a position to furnish further information regarding the situation involving the subjects at Las Vegas, Nevada.

Mr. Maheu insinuated that for a considerable period of time he has been working with the Central Intelligence Agency (CIA). In connection with this work, he has spent considerable time in Miami, Florida, area and has traveled extensively throughout the United States. He stated that this work could be verified by "Shef Edwards" (Colonel Sheffield Edwards, Director of Security, CIA).

Maheu stated that in connection with instant investigation, information was received that there was a possible leak of information on the part of an individual in the Chicago area. Mr. Maheu advised that he did not know the full name of this person and when asked if it were Samuel N. Giancana, he stated that he did not know the last name of the individual but described him as being a person who is very much in love with Phyllis McGuire of the McGuire Sisters Trio. He stated that since it was not possible to make direct contact with this individual, it was ascertained that Phyllis McGuire was very close to him and that she was one of the few people in whom he would confide. It was also determined that Miss McGuire was a close personal friend of Dan Rowan, who, during October, 1960, was working in Las Vegas, Nevada. Mr. Maheu stated that when it was ascertained that Phyllis McGuire was going to visit with

1 / 1007 87
ENCLOSURE

RE: ARTHUR JAMES BALLETTI; UNKNOWN SUBJECT; ALSO KNOWN
AS J. W. HARRISON

Rowan in Las Vegas, coverage of the meetings of these individuals should be made. He stated that investigators, one of which he later ascertained to be Balletti, were sent to Las Vegas with instructions that a technical surveillance of conversations within the hotel room of Rowan be ascertained. He stated that this coverage was intended to only be through microphones concealed in Rowan's room and not the monitoring of Rowan's telephone calls. He stated that there was no intention of violating the law but that apparently the investigators went further than they had been instructed. Mr. Maheu stated that it was through the stupidity of the operators that they were detected.

Mr. Maheu stated that he knows Balletti but does not know the identity of the other individual who is assigned to work with Balletti. Mr. Maheu indicated that he did not desire to furnish further details regarding this matter, stating that he was not familiar with all of the details. He indicated that he did not feel that he was in a position even at this time to furnish further information regarding his activities in this situation.

This document contains neither
recommendations nor conclusions of
the FBI. It is the property of
the FBI and is loaned to your agency;
it and its contents are not to be
distributed outside your agency.

Memorandum

Tolson	_____
Boardman	_____
Belmont	_____
Mohr	_____
Parsons	_____
Callahan	_____
Conrad	_____
DeLoach	_____
Evans	_____
Malone	_____
Rosen	_____
Tavel	_____
Trotter	_____
W.C. Sullivan	_____
Tele. Room	_____
Ingram	_____
Gandy	_____

TO : Mr. Parsons

DATE: 4/25/61

FROM : A. Rosen

SUBJECT: ARTHUR JAMES BALLETTI, et al.
UNAUTHORIZED PUBLICATION
OR USE OF COMMUNICATIONS
(UPUC)

Handwritten notes and signatures:
 [Large scribbles and initials, including what appears to be 'M. J. ...']
 [Initials 'JAC']
 [Initials 'W.C.S.']

At the Department's request, we are conducting investigation into wire tapping activities by Arthur James Balletti who was arrested by the Clark County Sheriff's Office, Las Vegas, Nevada, on local wire tapping charge. Balletti and one J. W. Harrison allegedly tapped the phone of Dan Rowan of the comedy team of Rowan and Martin. Rowan allegedly is romantically interested in Phyllis McGuire of the McGuire sisters trio, as is Sam Giancana, Chicago top hoodlum. Investigation thus far does not directly involve Giancana in this wire tapping activity.

The attached letterhead memorandum, a copy of which has been furnished to the Criminal Division in connection with the UPUC investigation contains information provided by Robert Maheu, Maheu and King Associates, Inc., Washington, D. C. Maheu is a former Bureau Special Agent. Maheu, when interviewed in connection with this case, 4/18/61, furnished information indicating he sent Balletti to Las Vegas to technically surveil conversations between Dan Rowan and Phyllis McGuire. Maheu said it was not his intention that the law would be violated and monitoring of Rowan's telephone calls was not intended. Telephone was tapped, however.

Maheu insinuated he has, for a considerable time, been working with the Central Intelligence Agency (CIA) in connection with the recent invasion of Cuba by anti-Castro forces. He said he has been traveling extensively throughout the United States particularly in Miami, Florida, area. Maheu advised he was quite disturbed by our UPUC investigation because it could possibly have jeopardized the work he has been doing.

OBSERVATIONS

Handwritten note: This is immaterial, how disturbed he gets. He is no good.

It is noted Maheu insinuates he has been operational in the United States for CIA and there may be a tie-in between this case and his anti-Castro work for CIA.

Enclosure
1 - Mr. Belmont

JAC:aeo
(7)

Handwritten notes and stamps:
 REC-24
 12 MAY 25 1961
 29
 6-01

Memorandum to Mr. Parsons
Re: Arthur James Balletti, et al.

RECOMMENDATIONS

It is recommended that this memorandum be forwarded to the Domestic Intelligence Division for its information and for any action it may wish to take. It appears CIA should be contacted regarding Maheu's activities on behalf of CIA in connection with the anti-Castro movement. At the same time, it should be determined whether Maheu's activities on behalf of CIA (if true) legitimately did include instant technical surveillance.

Handwritten initials and marks:
JAC
RC
V
EAP
D
M. J.
D.

5/12/61

AIRTEL

To: SACs, Las Vegas (139-1)
Chicago (139-105)
Los Angeles (139-77)
Miami (139-63)
Washington Field (139-61)

REC-24 Ex-102

From: Director, FBI (139-1201) — 40

ARTHUR JAMES BALLETTI, et al.
UPUC
OO: Las Vegas

ReWFOairtel and letterhead memorandum 4/20/61.

The information furnished by Maheu relative to his activities on behalf of CIA in this matter was discussed with Colonel Sheffield Edwards, Director of Security, CIA.

Edwards advised that in connection with CIA's operation against Castro that he personally contacted Maheu during the Fall of 1960 for the purpose of using Maheu as a "cut-out" in contacts with Sam Giancana (under investigation as a top hoodlum). Edwards said that since the underworld controlled gambling activities in Cuba under the Batista government, it was assumed that this element would still continue to have sources and contacts in Cuba which perhaps could be utilized successfully in connection with CIA's clandestine efforts against the Castro government. As a result, Maheu's services were solicited as a "cut-out" because of his possible entree into underworld circles. Maheu obtained Sam Giancana's assistance in this regard and according to Edwards, Giancana gave every indication of cooperating through Maheu in attempting to accomplish several clandestine efforts in Cuba. Edwards added that none of Giancana's efforts have materialized to date and that several of the plans still are working and may eventually "pay off."

*1 x 1/2
2 4 6
1/2*

MAILED 19
MAY 12 1961
COMM-FBI

- Tolson _____
- Fargson _____
- Mohr _____
- Belmont _____
- Callahan _____
- Conrad _____
- DeLoach _____
- Evans _____
- Malone _____
- Rosen _____
- Tavel _____
- Trotter _____
- W.C. Sullivan _____
- Tele. Room _____
- Ingram _____
- Gandy _____

1 - Mr. Staffeld
EJM:aeo
(13)

SEE NOTE PAGE 3

Handwritten signature/initials

Handwritten signature/initials

67 MAY 31 1961

MAIL ROOM TELETYPE UNIT

Airtel to SACs, LV, CG, LA, MM and WFO
Re: Arthur James Balletti, et al.

Edwards related that he had no direct contact with Giancana; that Giancana's activities were completely "back stopped" by Maheu; that Maheu would frequently report Giancana's action and information to Edwards; however, no details or methods used by Maheu or Giancana in accomplishing their missions were ever reported to Edwards. Edwards said that since this is "dirty business" he could not afford to be knowledgeable of Maheu and Giancana's actions in pursuit of any mission for CIA. Edwards added that he has neither given Maheu any instruction to use technical installations of any type nor has the subject of technical installations ever come up between Edwards and Maheu in connection with Giancana's activity. Edwards related that Maheu did come to him concerning the arrest in Las Vegas of Balletti for "wire tapping"; that Maheu cautioned Edwards that the Balletti arrest can cause CIA some embarrassment since Balletti was in Las Vegas attempting to obtain coverage on some "Hollywood people" in connection with Giancana's efforts for CIA. Edwards said that he did not know the facts of the Balletti case; that Maheu claims "Balletti went too far" in his efforts to obtain information. Edwards added that he was unaware of any reason for Maheu or Giancana's activity in Las Vegas; that Giancana's activity in furtherance of the anti-Castro activity was left completely in Maheu's hands.

Edwards advised that only Mr. Bissell (Deputy Director of Plans, CIA) and two others in CIA were aware of the Giancana-Maheu activity in behalf of CIA's program; that Allen Dulles was completely unaware of Edwards' contact with Maheu in this connection. He added that Mr. Bissell, during his recent briefings of General Taylor and the Attorney General in connection with their inquiries into CIA relating to the Cuban situation, that Mr. Bissell told the Attorney General that some of CIA's associated planning included the use of Giancana and the underworld against Castro.

From the above information obtained from CIA, it is difficult to determine any need for Maheu to require any coverage (including technical coverage) on Dan Rowan in connection with Giancana's reported efforts on behalf of CIA. It appears possible that Rowan was being covered by Maheu and his employees on behalf of Giancana relative to the reported conflict between Giancana and Rowan for the affections of Phyllis McGuire.

Airtel to SACs, LV, CG, LA, MM and WFO
Re: Arthur James Balletti, etal.

Every effort must be expended in order to ascertain the involvement of Maheu, Balletti and Giancana in this violation of the UPUC statute. In conducting interviews in this matter, the information from Colonel Edwards should be discreetly handled and his identity appropriately protected.

The Washington Field Office should reinterview Maheu and Fitzpatrick to further determine their roles in this matter.

In view of the information set forth above, the Chicago Office should penetratively interview Giancana to determine his connection with Maheu and if he requested the full coverage of Rowan including wire tapping of his phones.

The Miami Office should reinterview DuBois and Balletti for any knowledge of Giancana's part in this activity and for any further information which will resolve this matter.

Any investigation outstanding in Las Vegas should be completed and promptly reported.

This matter must be given top priority and sufficient personnel assigned to resolve this matter promptly in order to determine the involvement of Giancana, Balletti and Maheu. This case should be closely followed by the office of origin and reports submitted promptly to the Bureau and interested offices.

NOTE:

Case involves wire tap placed on phone of Dan Rowan of comedy team of Rowan and Martin. Rowan reportedly engaged to Phyllis McGuire of McGuire Sisters trio who is also reportedly a girl friend of Sam Giancana, under investigation by the Chicago Office as a top hoodlum. Maheu claims coverage of Rowan (although not to include telephone tap) put on in behalf of CIA's efforts to obtain intelligence information in Cuba through the hoodlum element which has had interests there. Memo being prepared to Department advising of information received from Col. Edwards, CIA.

FBI

Date: 5/23/61

Transmit the following in _____
(Type in plain text or code)

Via AIRTEL _____
(Priority or Method of Mailing)

TO : DIRECTOR, FBI (139-1201)
SAC, LAS VEGAS (139-1)

FROM: SAC, CHICAGO (139-105)

ARTHUR JAMES BALLETTI, ET AL
UPUC

Rebuairtel to Las Vegas, 5/12/61.

Efforts were made to make contact with SAM GIANCANA at all of his known hangouts, residence, and with associates on 5/16-19/61, with negative results.

b7c ANTHONY V. CHAMPAGNE, Attorney, 1 North La Salle, Chicago, telephonically advised SA [redacted], on 5/19/61 that "his client" (GIANCANA) had contacted him and advised him to relay a message to SA [redacted] to the effect that he did not desire to be interviewed on any matter. b7c CHAMPAGNE said that inasmuch as he was merely relaying the desires of his client, he did not feel it to be in his private interest to attempt to persuade GIANCANA to make himself available for an interview.

b7c Contact was made with [redacted] River Forest, Illinois, on 5/19/61, by SAs [redacted] and [redacted] at which time [redacted] advised that GIANCANA was "out of town" and refused to disclose his whereabouts. [redacted] is GIANCANA's close associate and bodyguard.

b2
b7c
b7D [redacted] GIANCANA had left town shortly after learning that FBI agents were attempting to contact him.

- 3 - Bureau
- 2 - Las Vegas
- 1 - Los Angeles (139-88) (Info)
- 1 - Miami (139-63) (Info)
- 1 - Washington Field (139-61)
- 2 - Chicago (139-105) (12-349)

REC-9 139-1201-41-100

17 MAY 25 1961

EX-101

DD - WORK

RRH:jjs
(10)

Approved: _____ Sent _____ M Per _____
Special Agent in Charge

57 JUN 2 1961

SEARCHED _____ INDEXED _____
SERIALIZED _____ FILED _____
MAY 25 1961
FBI - LAS VEGAS
DAN SA

CG 139-105

In connection with case entitled "SAMUEL M. GIANCANA, aka., AR", Chicago file 92-349, Bureau file 92-3171, further attempts will be made to affect an interview with GIANCANA on instant case.

RUC

GALE

5/24/61
NA

FBI

Date: 5/24/61

Transmit the following in AIRTEL
(Type in plain text or code)

Via AIRMAIL
(Priority or Method of Mailing)

To: Director, FBI (139-1201)

From: SAC, Miami (139-63)

ARTHUR JAMES BALLETTI; ET AL
UPUC
(Las Vegas - 00)

Re Bureau airtel dated 5/12/61.

On 5/22/61, [redacted] again advised he never heard of SAM GIANCANA.

On 5/24/61, ARTHUR JAMES BALLETTI advised he never heard of SAM GIANCANA.

Above by SA [redacted]

b7c Om

223

REC-9

139-1201-102

RUC.

- (3) - Bureau (AM)
 - 2 - Las Vegas (139-1)(AM)
 - 1 - Miami
- RKL:mfh
(6)

MAY 27 1961

EX 101

57 JUN 2 1961

MAY 25 10 40 AM '61

FBI

REC'D - AIR MAIL

Approved: [Signature]
Special Agent in Charge

Sent _____ M Per _____

UNITED STATES GOVERNMENT

Memorandum

Tolson	_____
Parsons	_____
Mohr	_____
DeLoach	_____
Evans	_____
Malone	_____
Rosen	_____
Sullivan	_____
Tavel	_____
Trotter	_____
Tele. Room	_____
Ingram	_____
Gandy	_____

TO : Mr. Parsons

DATE: May 4, 1961

FROM : A. H. Belmont

SUBJECT: ARTHUR JAMES BALLETTI, et al.
UNAUTHORIZED PUBLICATION
OF USE OF COMMUNICATIONS

Reference is made to Mr. Rosen's memorandum, April 25, last, on the captioned matter, referring to information furnished by Robert Maheu (former Bureau Agent) in which he indicated a possible tie-in with the anti-Castro activities of the Central Intelligence Agency (CIA). Since Maheu stated that "Shef Edwards" could verify his alleged anti-Castro activity, Liaison contacted Colonel Sheffield Edwards, Director of Security, CIA, (unavailable until 5-3-61) regarding this matter.

Edwards advised that in connection with CIA's operation against Castro that he personally contacted Maheu during the fall of 1960 for the purpose of using Maheu as a "cut-out" in contacts with Sam Giancana (under investigation as a top hoodlum). Edwards said that since the underworld controlled gambling activities in Cuba under the Batista government, it was assumed that this element would still continue to have sources and contacts in Cuba which perhaps could be utilized successfully in connection with CIA's clandestine efforts against the Castro Government. As a result, Maheu's services were solicited as a "cut-out" because of his possible entre into underworld circles. Maheu obtained Sam Giancana's assistance in this regard and according to Edwards, Giancana gave every indication of cooperating through Maheu in attempting to accomplish several clandestine efforts in Cuba. Edwards added that none of Giancana's efforts have materialized to date and that several of the plans still are working and may eventually "pay off."

Edwards related that he had no direct contact with Giancana; that Giancana's activities were completely "back stopped" by Maheu; that Maheu would frequently report Giancana's action and information to Edwards, however, no details or methods used by Maheu or Giancana in accomplishing their missions were ever reported to Edwards. Edwards said that since this is "dirty business" he could not afford to be knowledgeable of Maheu and Giancana's action in pursuit of any mission for CIA. Edwards

- MKB:ban
(8)
- 1 - Mr. Parsons
 - 1 - Mr. Belmont
 - 1 - Mr. Rosen
 - 1 - Mr. C. A. Evans
 - 1 - Mr. McDonough
 - 1 - Liaison; 1 - Mr. Kuhrtz

EX-103 REC-23

17 MAY 31 1961

RECORDED COPY FILED IN

Memorandum Belmont to Parsons
Re: ARTHUR JAMES BALLETTI, et al.
UNAUTHORIZED PUBLICATION
OF USE OF COMMUNICATIONS

added that he has neither given Maheu any instruction to use technical installations of any type nor has the subject of technical installations ever come up between Edwards and Maheu in connection with Giancana's activity. Edwards related that Maheu did come to him concerning the arrest in Las Vegas of Balletti for "wire tapping"; that Maheu cautioned Edwards that the Balletti arrest can cause CIA some embarrassment since Balletti was in Las Vegas attempting to obtain coverage on some "Hollywood people" in connection with Giancana's efforts for CIA. Edwards said that he did not know the facts of the Balletti case; that Maheu claims "Balletti went too far" in his efforts to obtain information. Edwards added that he was unaware of any reason for Maheu or Giancana's activity in Las Vegas; that Giancana's activity in furtherance of the anti-Castro activity was left completely in Maheu's hands.

Edwards advised that only Mr. Bissell (Deputy Director of Plans, CIA) and two others in CIA were aware of the Giancana - Maheu activity in behalf of CIA's program; that Allen Dulles was completely unaware of Edwards' contact with Maheu in this connection. He added that Mr. Bissell, during his recent briefings of General Taylor and the Attorney General in connection with their inquiries into CIA relating to the Cuban situation, ~~that Mr. Bissell~~ told the Attorney General that some of CIA's associated planning included the use of Giancana and the underworld against Castro.

OBSERVATIONS:

Although Edwards denies any knowledge of the use of technical equipment by Maheu in Maheu's activity with Giancana, it can be speculated that Maheu could have mentioned his possible use of technical equipment in this matter and Edwards just "closed his eyes" to such matters and pushed Maheu for results regardless of the means to obtain these results. Also from the facts available to the Bureau, it is difficult to determine a need for Maheu to require any coverage (including technical coverage) on Dan Rowan in connection with Giancana's efforts in behalf of CIA. On the other hand, it would appear more likely that Dan Rowan was being

Memorandum Belmont to Parsons
Re: ARTHUR JAMES BALLETTI, et al.
UNAUTHORIZED PUBLICATION
OF USE OF COMMUNICATIONS

covered by Maheu in connection with personal reasons for Giancana rather than any reason in behalf of CIA's program. This would appear particularly true in view of Giancana's ill-fated love affair with Phyllis McGuire of the McGuire sisters' trio, who is engaged to Rowan.

ACTION:

It is recommended that this memorandum be forwarded to the General Investigative Division for its information and for any further action in connection with the captioned investigation.

[Handwritten notes and signatures]
Q
yes & press ...
Giancana, ...
& Balletti.
dx

TOP SECRET

The Attorney General

CONFIDENTIAL

May 22, 1961

Director, FBI

139-1201-43

REC-23

EX-105

**ARTHUR JAMES BALLETTI, et al.
UNAUTHORIZED PUBLICATION
OR USE OF COMMUNICATIONS**

Deleted Copy Sent F. Taylor Brack
by Letter Dated 12/15/76
Per FOIPA Request HR

READING ROOM

MAY 23 06 PM '61

This case involves an allegation that Arthur James Balletti and another unidentified individual placed a wire tap on the telephone of Dan Rowan, a member of the comedy team of Rowan and Martin, in October, 1960.

The Criminal Division was previously advised that Robert Maheu, after concealing his full connection with this matter, informed that coverage of Rowan was in furtherance of activities of Maheu on behalf of the Central Intelligence Agency (CIA) relative to anti-Castro activities.

Colonel Sheffield Edwards, Director of Security, CIA, furnished the information set forth in the attached memorandum regarding his utilization of Maheu in connection with anti-Castro activities. According to Colonel Edwards, Maheu contacted Sam Giancana in connection with this program. Reports of investigation of Giancana have been furnished to the Department in the case entitled "Samuel N. Giancana, Anti-Racketeering."

Since the purpose for placing the wire tap on Rowan's telephone, which is the basis for this investigation of the violation of the Unauthorized Publication or Use of Communications Statute, has not been determined, the full investigation requested in this matter is continuing and copies of reports will be furnished to the Department upon receipt.

In view of the information regarding CIA's attempted utilization of the hoodlum element in connection with anti-Castro activities, CIA has requested that this information be handled on a "need-to-know" basis.

Enclosures (2)

- 1 - Mr. Byron R. White
Deputy Attorney General (Enclosure)
- 1 - Assistant Attorney General
Herbert J. Miller, Jr. (Enclosure)
- 1 - Mr. Evans (Enc.)
- 1 - Mr. Belmont (Enc.)

- Tolson
- Felt
- Mohr
- DeLoach
- Evans
- Malone
- Rosen
- Tavel
- Trotter
- W.C. Sullivan
- Tele. Room
- Ingram
- Gandy

EJN:aeo (12) 67 JUN 1 1961

RECEIVED
FEDERAL BUREAU OF INVESTIGATION
MAY 23 1961

CONFIDENTIAL

SEE NOTE PAGE 2

CONFIDENTIAL
REC. IN Lt 12/2/70. GTT

*Xerox to Legal Counsel 6/1/75
For people disson & Santa
Solid Committee, Mr. C. A. H.*

~~TOP SECRET~~
~~CONFIDENTIAL~~

NOTE:

Case involves wire tap placed on phone of Dan Rowan of comedy team of Rowan and Martin. Rowan reportedly engaged to Phyllis McGuire of McGuire Sisters trio who is also reportedly a girl friend of Sam Giancana, under investigation by the Chicago Office as a top hoodlum. Maheu claims coverage of Rowan (although not to include telephone tap) put on in behalf of CIA's efforts to obtain intelligence information in Cuba through the hoodlum element which has had interests there. From the information furnished by Maheu and CIA, it is difficult to determine any need for Maheu to put full coverage on Rowan (including wire tap) in connection with Giancana's reported efforts on behalf of CIA. It appears possible Rowan was being covered by Maheu on behalf of Giancana ~~XXXXXXXXXXXXXXXXXXXXXXXXXXXX~~ relative to the reported conflict between Giancana and Rowan for the affections of Phyllis McGuire. In view of this, investigation is being vigorously pressed and airtel was sent 5/12/61 to LV and other offices having leads in this matter. Information in attached letterhead memo relative to CIA's utilization of Maheu in its anti-Castro program was furnished to Liaison Agent by Col. Sheffield Edwards, Director of Security, CIA.

In accordance with arrangements made between Liaison and CIA, this information relative to anti-Castro activities on behalf of CIA by Maheu and Giancana should be limited to those in the Department on a "need-to-know" basis. Dissemination only being made to Department. This should be routed through Division 5 for its information.

~~CONFIDENTIAL~~
~~CONFIDENTIAL~~

~~TOP SECRET~~
~~CONFIDENTIAL~~
CONFIDENTIAL

May 22, 1961

ARTHUR JAMES BALLETTI, et al.

On May 3, 1961, Colonel Sheffield Edwards, Director of Security, Central Intelligence Agency (CIA) furnished the following information:

Colonel Edwards advised that in connection with CIA's operation against Castro he personally contacted Robert Maheu during the Fall of 1960 for the purpose of using Maheu as a "cut-out" in contacts with Sam Giancana, a known hoodlum in the Chicago area. Colonel Edwards said that since the underworld controlled gambling activities in Cuba under the Batista government, it was assumed that this element would still continue to have sources and contacts in Cuba which perhaps could be utilized successfully in connection with CIA's clandestine efforts against the Castro government. As a result, Maheu's services were solicited as a "cut-out" because of his possible entree into underworld circles. Maheu obtained Sam Giancana's assistance in this regard and according to Edwards, Giancana gave every indication of cooperating through Maheu in attempting to accomplish several clandestine efforts in Cuba. Edwards added that none of Giancana's efforts have materialized to date and that several of the plans still are working and may eventually "pay off."

Colonel Edwards related that he had no direct contact with Giancana; that Giancana's activities were completely "back stopped" by Maheu and that Maheu would frequently report Giancana's action and information to Edwards. No details or methods used by Maheu or Giancana in accomplishing their missions were ever reported to Edwards. Colonel Edwards said that since this is "dirty business" he could not afford to have knowledge of the actions of Maheu and Giancana in pursuit of any mission for CIA. Colonel Edwards added that he has neither given Maheu any instruction to use technical installations of any type nor has the subject of technical installations ever come up between Edwards and Maheu in connection with Giancana's activity.

- Tolson _____
- DeLoach _____
- Mohr _____
- Bishop _____
- Casper _____
- Callahan _____
- Conrad _____
- Felt _____
- Gale _____
- Rosen _____
- Sullivan _____
- Tavel _____
- Trotter _____
- Tele. Room _____
- Ingram _____
- Gandy _____

ORIGINAL TO DEPARTMENT

CONFIDENTIAL

EJM:aeq/10

ENCLOSURE

(14)

- 1 - Mr. Evans
- 1 - Mr. Belmont

139-1201-

See cover memo to AG, 5/22/61, same caption, EJM:aeo

MAIL ROOM TELETYPE UNIT

~~TOP SECRET~~

CONFIDENTIAL

Colonel Edwards related that Maheu did come to him concerning the arrest in Las Vegas of Balletti for "wire tapping." Maheu cautioned Edwards that the Balletti arrest could cause CIA some embarrassment since Balletti was in Las Vegas attempting to obtain coverage on some "Hollywood people" in connection with Giancana's efforts for CIA. Edwards said that he did not know the facts of the Balletti case and Maheu claims "Balletti went too far" in his efforts to obtain information. Edwards added that he was unaware of any reason for this activity of Maheu or Giancana in Las Vegas and that Giancana's activity in furtherance of the anti-Castro activity was left completely in Maheu's hands.

Colonel Edwards advised that only Mr. Bissell (Deputy Director of Plans, CIA) and two others in CIA were aware of the Giancana - Maheu activity in behalf of CIA's program and that Allen Dulles was completely unaware of Edwards' contact with Maheu in this connection. He added that Mr. Bissell, during his recent briefings of General Taylor and the Attorney General in connection with their inquiries into CIA relating to the Cuban situation, told the Attorney General that some of CIA's associated planning included the use of Giancana and the underworld against Castro.

"Property of FBI
This report and its contents are
loaned to you by the FBI, and
neither it nor its contents are
to be distributed outside the agency
to which loaned."

CONFIDENTIAL

- 2 -

CONFIDENTIAL

~~TOP SECRET~~

FBI

Date: 5/26/61

AIRTEL

Transmit the following in (Type in plain text or code)

AIRMAIL

Via (Priority or Method of Mailing)

- Mr. Parsons
- Mr. Mohr
- Mr. Belmont
- Mr. Callahan
- Mr. Conrad
- Mr. DeLoach
- Mr. Evans
- Mr. Malone
- Mr. Rosen
- Mr. Tavel
- Mr. Trotter
- Mr. W.C. Sullivan
- Tele. Room
- Mr. Ingram
- Miss Gandy

To: Director, FBI (139-1201)

From: SAC, Miami (139-63)

ARTHUR JAMES BALLETTI; ET AL
UPUC
(Las Vegas - 00)

Mc...

b7c

Rerep of SA [redacted] dated 5/22/61 at Las Vegas.

In view of information furnished by T. W. RICHARDSON, will reinterview ARTHUR JAMES BALLETTI.

- P.
- (3) - Bureau (AM)
- 2 - Las Vegas (139-1)(AM)
- 2 - Miami
- RKL:mfh
- (7)

m

EX 101

REC-94

139-1201-44

W
SEARCHED
SERIALIZED
INDEXED
MAY 27 1961

MAY 30 1961

REC-94
6-9

66 JUN 5 1961
Approved: _____
Special Agent in Charge

Sent _____ M Per _____

FEDERAL BUREAU OF INVESTIGATION

Reporting Office WASHINGTON FIELD	Office of Origin LAS VEGAS	Date 6/6/61	Investigative Period 5/25/61
TITLE OF CASE ARTHUR JAMES BALLETTI; UNKNOWN SUBJECT, aka J. W. Harrison		Report made by [REDACTED] b7c	Typed By: shs/ll
		CHARACTER OF CASE UPUC	

SYNOPSIS:

REFERENCE

Bureau airtel to Las Vegas dated 5/12/61.

- RUC -

Handwritten notes in left margin:
X
2
...
Ex possible liaison to Senate
Select Committee on CIA, etc.

Handwritten initials: JH

Approved <i>[Signature]</i> Special Agent In Charge	Do not write in spaces below		
Copies made: 2 - Bureau (139-1201) 1 - Chicago (139-105) (Info) 3 - Las Vegas (139-1) (1 - USA, Reno, Nevada) 1 - Los Angeles (139-77) (Info) 1 - Miami (139-63) 1 - Washington Field (139-61)	139-1201-45		REC-105
	8 JUN 6 1961		
	<i>[Handwritten stamp]</i>		

*Rec: AAG Criminal Division EVM
Form 6-94 (3) 6-9-61*

- A* -
COVER PAGE

Handwritten stamps and signatures:
STAT...
C.O. - ...
[Signature]

62 JUN 15 1961

UNITED STATES DEPARTMENT OF JUSTICE
FEDERAL BUREAU OF INVESTIGATION

~~CONFIDENTIAL~~

Copy to: USA, Reno, Nevada

Report of: [REDACTED]

Office: Washington, D. C.

Date: 6/6/61

Field Office File No.: 139-61

Bureau File No.: 139-1201

Title: ARTHUR JAMES BALLETTI;
UNKNOWN SUBJECT, also known as
J. W. Harrison

Character: UNAUTHORIZED PUBLICATION AND USE OF COMMUNICATIONS

Synopsis:

7/1/61
10/1/61

MAHEU advised, during Fall, 1960, at request of CIA, contacted SAM GIANCANA in Chicago for information regarding Cuban activities. While working with GIANCANA, it was believed that a leak of information had developed and it was decided to cover the activities of PHYLLIS MC GUIRE and DON ROWAN. Decision to install microphone coverage of ROWAN's room in Las Vegas made by MAHEU. MAHEU believes BALLETTI went too far in installing telephone coverage. MAHEU worked through DUBOIS for this coverage. DUBOIS supplied both men who worked on this installation. Pretext of Los Angeles attorney used as DUBOIS did not know of CIA's interests in this matter. MAHEU unable to identify unknown subject, aka HARRISON.

- RUC -



Date 6/2/61

Washington, D.C.
 ROBERT MAHEU, Maheu and King Associates Incorporated, 1125 19th Street, N.W., advised that during the latter part of 1960, he was contacted by Colonel SHEFFIELD EDWARDS, Director of Security, Central Intelligence Agency (CIA). Colonel EDWARDS requested MAHEU to contact SAM GIANCANA in Chicago, Illinois, since gambling activities in Cuba, under the BATISTA government, were controlled by the underworld, it was believed that GIANCANA would still have sources and contacts in Cuba which could possibly be used in connection with CIA's activities against the CASTRO government.

MAHEU stated that the original contact with GIANCANA was made by "JOHNNY," who MAHEU declined to further identify. MAHEU stated that he talked with GIANCANA on several occasions but was never sure of his true name. MAHEU advised that while working with GIANCANA, information was received that his interests in the Cuban situation was being disclosed by GIANCANA to other individuals.

MAHEU stated that it was ascertained that GIANCANA was very much in love with PHYLLIS MC GUIRE of the McGuire Sisters Trio, and had, in fact, asked Miss MC GUIRE to marry him. It was his understanding that Miss MC GUIRE had rejected GIANCANA's offer but was still considered a close, personal friend of GIANCANA. It was believed that if GIANCANA had talked of MAHEU's interests in the Cuban situation that he might possibly have mentioned it to PHYLLIS MC GUIRE. MAHEU also stated that it has been ascertained that PHYLLIS MC GUIRE was a close, personal friend of DAN ROWAN of the comedy team of Rowan and Martin. It was learned that during October, 1960, ROWAN was working in Las Vegas, Nevada, and that PHYLLIS MC GUIRE was going to visit ROWAN in Las Vegas.

MAHEU stated that he decided to have microphone coverage installed in ROWAN's room in Las Vegas. MAHEU stated that he had made this decision himself recognizing the risk involved in setting up this coverage. He stated that he was extremely careful as he did not want to involve CIA.

MAHEU stated that in order to secure coverage of ROWAN and Miss MC GUIRE, he instructed WALTER FITZPATRICK, an associate of MAHEU, to contact EDWARD DUROIS, Investigations

On 5/25/61 at Washington, D. C. File # WFO 139-61
 by b7C SAs [redacted] and [redacted] CWB:shs/lbh Date dictated 6/1/61

This document contains neither recommendations nor conclusions of the FBI. It is the property of the FBI and is loaned to your agency; it and its contents are not to be distributed outside your agency.

~~TOP SECRET~~

Incorporated, Miami, Florida, to arrange to have DUBOIS send two men to Las Vegas to install and operate microphone coverage of ROWAN. MAHEU stated that he could not recall the exact instructions that he had given but it was his intentions to have only microphone coverage maintained in ROWAN's room. He felt that BALLETTI and the unknown subject went too far in installing telephone coverage of ROWAN.

MAHEU advised that DUBOIS did not know of CIA's interests in this matter and in requesting DUBOIS to handle this assignment, he had used a pretext indicating to DUBOIS that a Los Angeles, California, attorney had made the original request for coverage of ROWAN. MAHEU stated that he was in touch with DUBOIS on several occasions but denied that he had called DUBOIS, instructing DUBOIS to send only one man to Las Vegas and that he, MAHEU, would supply the second man. MAHEU stated that he did not know BALLETTI prior to this incident but did talk with BALLETTI on the telephone after BALLETTI was arrested. He made arrangements for an attorney to defend BALLETTI but again declined to furnish the details of these arrangements.

b7C Subsequent to the interview with MAHEU, he telephonically contacted SA [REDACTED] on May 25, 1961, advising that he had sent word to SAM GIANCANA as to the extent of the investigation which had been conducted by MAHEU of GIANCANA. MAHEU stated that since GIANCANA would probably be interviewed regarding this matter, he felt that it would be less embarrassing to him, MAHEU, if GIANCANA knew of this situation.

MAHEU again stated that he alone had made the decision to install the technical surveillance of ROWAN, that he had considered the risk involved and that in setting it up, he was trying to eliminate the possibility of involvement of CIA.

MAHEU stated that in the event it were decided to recontact him regarding this matter, he could always be reached through his office in Washington, D. C., or his home in Falls Church, Virginia.

~~TOP SECRET~~

6/7/61

AIRTEL

**To: SACs, Las Vegas (139-1)
Los Angeles (139-77)
Miami (139-63)
Washington Field (139-61)**

From: Director, FBI (139-1201)

**ARTHUR JAMES BALLETTI
UNKNOWN SUBJECT, aka., J. W. HARRISON
UPUC
OO: LAS VEGAS**

ReBuairtel 5/12/61 which instructed that this matter must be afforded top priority.

You are instructed to advise by return airtel the date report submitted by each office and name of reporting Agent. Las Vegas will advise any other offices having outstanding leads to expedite submission. All investigation ~~must be completed and reports submitted by 6/13/61. If there is any reason why this deadline cannot be met, the Bureau must be immediately advised by return airtel.~~

SEARCHED _____ INDEXED _____
SERIALIZED _____ FILED _____
JUN 13 1961
FBI - LAS VEGAS

- Tolson _____
- Belmont _____
- Mohr _____
- Callahan _____
- Conrad _____
- DeLoach _____
- Evans _____
- Malone _____
- Rosen _____
- Sullivan _____
- Tavel _____
- Trotter _____
- Tele. Room _____
- Ingram _____
- Gandy _____

LEC:dsj
(10)

62 JUN 12 1961

TELETYPE UNIT

EX-113

JUN 13 1961

1-46

FBI

Date: 6/8/61

Transmit the following in _____
(Type in plain text or code)

Via AIRTEL _____
(Priority or Method of Mailing)

TO: DIRECTOR, FBI (139-1201)

FROM: SAC, WFO (139-61)

ARTHUR JAMES BALLETTI;
UNSUB; aka J. W. Harrison
UPUC
(OO:LV)

mw
h

ReBuairtel dated 6/7/61, and report of SA [redacted] dated 6/6/61, at Washington, D.C.

b7c

[redacted] RUC report submitted on 6/6/61, by SA [redacted] at Washington, D.C.

RUC
3-Bureau
1-Las Vegas (Info)
1-WFO

HBM:bsb
(5)

REC-92

139-1201-47

11 JUN 8 1961

EX-113

AIRTEL

[Handwritten signatures and stamps]
SEC'D - CIV RIGHTS

Approved: _____ Sent _____ M Per _____
Special Agent in Charge

55 JUN 13 1961

6-141

FBI

Date: 6/8/61

Transmit the following in PLAIN TEXT
(Type in plain text or code)

Via AIRTEL AIRMAIL
(Priority or Method of Mailing)

TO: Director, FBI (139-1201)

FROM: SAC, Miami (139-63)

RE: ARTHUR JAMES BALLETTI;
ET AL
UPUC
OO - Las Vegas

ReBuairtel, 6/7/61.

b7c Report of SA [redacted] *reflecting* requesting re-interview
of subject will be submitted 6/9/61.

- P.
- 3 - Bureau (AM)
- 2 - Las Vegas (139-1) (AM)
- 2 - Miami
- RKL:cms
- (7)

EX-116

REC-26

20 JUN 12 1961

[Handwritten signatures and initials]

Approved: [Signature]
Special Agent in Charge

Sent _____ M Per _____

62 JUN 15 1961

6-14

FBI

Date: 6/9/61

Transmit the following in PLAIN
(Type in plain text or code)

Via AIRTEL AIR MAIL
(Priority or Method of Mailing)

TO: DIRECTOR, FBI (139-1201)
FROM: SAC, LOS ANGELES (139-77)
RE: ARTHUR JAMES BALLETTI;
UNKNOWN SUBJECT, aka
J. W. Harrison
UPUC
OO: LAS VEGAS

~~REC-26~~

b7c Rerep of SA [redacted] dated 6/6/61 at Washington Field and report of SA [redacted] dated 4/12/61 at Los Angeles.

On the basis of the information developed to date in this investigation, it appears that there is a strong possibility that JOHN ROSELLI, aka John Rosselli, who is a National Top Hoodlum and the subject of a current investigation by the Los Angeles Office, may be involved in this case and may be the individual who registered at the Kenilworth Hotel in Miami Beach, Florida, in October, 1960, as J. A. ROLLINS. The following information is set forth to support this possibility:

- RUC -
- 2 - Bureau (139-1201)
- 2 - Las Vegas (139-1)(AM)
- 2 - Washington Field (139-61)(AM)
- 2 - Miami (139-63)(AM)
- 2 - Chicago (92-349)(AM)
- 2 - Los Angeles
 - (1 - 92-113)
 - (1 - 139-77)

JMB:bem
(12)

REC-26

139-1201

149 attached

JUN 12 1961

EX-116

[Handwritten signatures and initials]

Approved: [Signature]
Special Agent in Charge

Sent _____ M Per _____

62 JUN 15 1961

LA 139-77

b7C 1. J. A. ROLLINS was charged with telephone calls to [REDACTED], telephone number WH 3-1155, Chicago, Illinois. [REDACTED] is a very close friend and associate of ROSELLI.

b7C 2. ROLLINS was charged with a call to [REDACTED] telephone number [REDACTED] California. [REDACTED] is also a close friend and associate of ROSELLI.

3. ROLLINS was charged with a call to the Desert Inn Hotel, telephone number DU 2-6000, Las Vegas, Nevada. ROSELLI has received many telephone calls at the Desert Inn Hotel.

4. JAMES CANTILLON, Beverly Hills, California, attorney, was called by BALLETTI subsequent to his arrest. CANTILLON is ROSELLI's attorney and has been a business associate of ROSELLI. On 11/1/60, CANTILLON's law office was charged with a telephone call to BOB MAHEU, telephone number JE 3-9655, Washington, D.C. MAHEU has stated that he used as a cover for the Las Vegas investigation, a pretext that a Los Angeles attorney had requested the investigation. MAHEU has refused to identify the attorney. It is not known at the present time whether MAHEU actually had the attorney make the request or whether he, MAHEU, merely told EDWARD DU BOIS that an attorney had made the request. In any event, MAHEU probably would have contacted the attorney and received permission to use the attorney's name. JAMES CANTILLON has been interviewed and denied that he participated in this matter except to recommend a Las Vegas attorney to BALLETTI.

5. On interview on 5/25/61, MAHEU stated that the original contact with GIANCANA was made by "JOHNNY" who MAHEU declined to identify. ROSELLI is acquainted with a number of Chicago hoodlums and no doubt is acquainted with GIANCANA.

6. Recent check of toll telephone calls charged to ROSELLI reflects that on 4/29/61, he was charged with calls to the following numbers:

LA 139-77

JE 3-9655 - Falls Church, Virginia (CANTILLON called BOB MAHEU at this number on 11/1/60)

SU 7-7200 - Chicago, Illinois

UN 4-2922 - Miami, Florida

The subscribers to the Chicago and Miami numbers are not known to the Los Angeles Office.

7. ROSELLI has had contact with R. W. RICHARDSON in the past.

Unless advised to the contrary by the Bureau or the Las Vegas Office, it is suggested that the following investigation be conducted:

WASHINGTON FIELD

AT WASHINGTON, D.C.

Reinterview MAHEU and ask him if "JOHNNY", J.A. or JOHN A. ROLLINS is JOHN ROSELLI.

MIAMI

AT MIAMI, FLORIDA

1. Ascertain the subscriber to telephone number UN 4-2922.

2. Exhibit photograph of JOHN ROSELLI to appropriate personnel at the Kenilworth Hotel to determine if they can identify ROSELLI as J. A. ROLLINS.

3. Submit the original registration card of J. A. ROLLINS to the FBI Laboratory, Document Section, so that the handwriting may be compared with ROSELLI's handwriting, which is on file at the Bureau in the ROSELLI case, Bufile 92-3267.

LA 139-77

CHICAGO

AT CHICAGO, ILLINOIS

Ascertain the subscriber to telephone number
SU 7-7200.

FEDERAL BUREAU OF INVESTIGATION

Reporting Office MIAMI	Office of Origin LAS VEGAS	Date 6/9/61	Investigative Period 6/8/61
TITLE OF CASE ARTHUR JAMES BALLETTI; UNKNOWN SUBJECT, aka J. W. Harrison		Report made by [REDACTED] <i>b7C</i>	Typed By gfg
		CHARACTER OF CASE UPUC <i>b7C</i>	

Synopsis:

REFERENCES: Report SA **[REDACTED]**, 5/22/61, Las Vegas.
Miami airtel to Bureau 5/26/61.
Bureau airtel 6/7/61.
Miami airtel to Bureau 6/8/61.

- RUC -

ADMINISTRATIVE

On 6/8/61, ARTHUR JAMES BALLETTI advised he did not desire to take a polygraph examination. He said that if the T. W. RICHARDSON whom he contacted at the New Frontier Hotel, Las Vegas, would submit to a polygraph, he might then consider doing likewise.

- A* -

- COVER PAGE -

Approved <i>WJ</i> Special Agent In Charge	Do not write in spaces below		REC-41
Copies made: 2 - Bureau (139-1201) 3 - Las Vegas (139-1) (1 - USA, Reno) 1 - Miami (139-63) 1cc: AAG Criminal Division <i>E. J. J.</i> Form 6-94 <i>[Handwritten]</i>	139-1201-50		EX-114
	20 JUN 12 1961		

UNITED STATES DEPARTMENT OF JUSTICE
FEDERAL BUREAU OF INVESTIGATION

Copy to: 1 - U. S. Attorney, Reno, Nevada

Report of: [REDACTED] b7c

Office: MIAMI, FLORIDA

Date:

June 9, 1961

Field Office File No.:

139-63

Bureau File No.: 139-1201

Title:

ARTHUR JAMES BALLETTI;
UNKNOWN SUBJECT, aka
J. W. Harrison

Character:

UNAUTHORIZED PUBLICATION AND USE OF COMMUNICATIONS

Synopsis:

ARTHUR JAMES BALLETTI insists he received \$1,000 fee from a T. W. RICHARDSON, New Frontier Hotel, Las Vegas, Nev., on 10/30 or 31/60. Denied knowing SAM GIANCANA.

- RUC -

DETAILS:

Date June 9, 1961

On June 8, 1961, efforts were made to contact ARTHUR JAMES BALLETTI at his office, Investigators, Inc., Ainsley Building. BALLETTI subsequently on the same date telephonically contacted the Miami Office and advised that he has no further information to furnish regarding his activities in Las Vegas and has told the complete truth about the entire matter. He said he saw no point in further discussion of this affair. He reiterated that on either October 30 or 31, 1960, he had contacted an individual known to him as T. W. RICHARDSON at the New Frontier Hotel, Las Vegas, Nevada. He said he had received \$1,000 in cash from this person which he assumed was his fee for his work in Las Vegas. He said he did not tell this man his name and had only very brief contact with him. He said he knew nothing of this man ever being in Reno but presumed that he was well known at the New Frontier Hotel, Las Vegas. BALLETTI said he had never previously been in Las Vegas and was not acquainted with anyone in that city and did not simply dream up the name T. W. RICHARDSON. He said this name was given him by ROBERT MAIEU in a long distance telephone call. He advised he felt sure he would know RICHARDSON if he were to see him again.

BALLETTI said that he has never heard of SAM GIANCANA and the name means absolutely nothing to him.

- 2* -

On 6/8/61 at Miami, Florida File # Miami 139-63
by SA [REDACTED] :gfg Date dictated 6/9/61

FBI

Date: 6/12/61

Transmit the following in PLAIN TEXT
(Type in plain text or code)

Via AIRTEL AIR MAIL
(Priority or Method of Mailing)

✓
 FROM: SAC, LAS VEGAS (139-1)
 RE: ARTHUR JAMES BALLETTI;
 UNSUB, aka
 J. W. Harrison
 UPUK
 (OO: Las Vegas)

Re Buairtel, 6/7/61, Los Angeles airtel to Bureau dated 6/9/61.

The following reports have been submitted by Las Vegas in this matter:

b7C
 Report of SA [redacted] dated 11/10/60 at Salt Lake City; report of SA [redacted] dated 12/30/60 at Salt Lake City; Report of SA [redacted] dated 2/8/61 at Salt Lake City; report of SA [redacted] dated 4/11/61 at Las Vegas; report of SA [redacted] dated 5/22/61 at Las Vegas.

It is noted that Chicago has also submitted report of SA [redacted] (A) dated 3/17/61 at Chicago.

Referenced Los Angeles airtel 6/9/61 sets forth suggested leads for Washington Field Office, Miami, and Chicago. In view of the fact that there does exist a possibility that JOHN ROSELLI, subject of case entitled JOHN ROSELLI, aka, A-R, Los Angeles, may be involved in this matter, it appears pertinent to Las Vegas that the suggested investigation by Los Angeles be carried out immediately; therefore, Washington Field, Miami, and Chicago handle and sureport immediately

P

- 3 - Bureau
- 1 - Washington Field Office (139-61)
- 1 - Miami (139-63)
- 1 - Chicago (139-105)
- 1 - Los Angeles (139-105)
- 2 - Las Vegas (139-11561)

MBP/nlw
(9)

Approved: JUN 15 1961 Sent _____ M Per _____
 C C Wick Special Agent in Charge

LV 139-1

Miami has also been requested to reinterview subject BALLETTI relative to his claim that T. W. RICHARDSON paid him \$1,000. while subject was in Las Vegas. It is noted T. W. RICHARDSON, when interviewed at Reno, Nevada, denied paying BALLETTI any money and denied even knowing BALLETTI.

UACB, upon receipt of results of investigation presently being conducted, this matter will be presented to the United States Attorney at Las Vegas in order that this matter may be brought to a logical conclusion.

8/14/61

AIRTEL

**To: SACs, Los Angeles (139-77)
Las Vegas (139-1)
Miami (139-63)
Washington Field (139-61)
Chicago (**

From: Director, FBI (139-1201)

**ARTHUR JAMES BALLETTI
UNKNOWN SUBJECT, aka J. W. Harrison
UFUC
OO: Las Vegas**

pc } 5

ReLAairtel 6/9/61. Vigorously pursue leads set out in reairtel.

Los Angeles, furnish photo of Rosselli to Las Vegas in order that Las Vegas can display photo to personnel at the Riviera Hotel, Las Vegas, to ascertain if he is identical with J. W. Harrison. Las Vegas should forward hotel reservation card bearing signature of J. W. Harrison to Laboratory for comparison with signature of Rosselli.

In addition to other leads set out for Miami in Los Angeles airtel 6/9/61, display photo of Rosselli to Balletti to ascertain if identical with J. W. Harrison.

1 - Mr. Staffeld

NOTE:

Case involves wire tap placed on phone of Dan Rowan, member of comedy team of Rowan and Martin. Subject Balletti has stated that tap was placed by J. W. Harrison who was not further known to him. Robert Maheu, former BuAgent, stated he ordered coverage of Rowan on behalf of CIA's anti-Castro activities but did not order telephone tap. Present developments indicate Sam Giancana and possibly John Rosselli (both under investigation as top hoodlums in CG and LA, respectively) may be involved. All aspects of case being vigorously pursued to resolve matter.

MAILED 4
JUN 13 1961
COMM-FBI
REC-66
JUN 14 1961

son _____
front _____
shi _____
ilcha _____
and _____
Loch _____
one _____
loner _____
osen _____
illiva _____
avel _____
rotter _____
ele, from _____
ind _____

66 JUN 16 1961

EJM:aeo
(13)
TELETYPE UNIT

EJM

Memorandum

TO : The Attorney General

DATE: May 22, 1961

FROM : Director, FBI

SUBJECT: ARTHUR JAMES BALLETTI, et al.
UNAUTHORIZED PUBLICATION
OR USE OF COMMUNICATIONS

This case involves an allegation that Arthur James Balletti and another unidentified individual placed a wire tap on the telephone of Dan Rowan, a member of the comedy team of Rowan and Martin, in October, 1960.

The Criminal Division was previously advised that Robert Maheu, after concealing his full connection with this matter, informed that coverage of Rowan was in furtherance of activities of Maheu on behalf of the Central Intelligence Agency (CIA) relative to anti-Castro activities.

Colonel Sheffield Edwards, Director of Security, CIA, furnished the information set forth in the attached memorandum regarding his utilization of Maheu in connection with anti-Castro activities. According to Colonel Edwards, Maheu contacted Sam Giancana in connection with this program. Reports of investigation of Giancana have been furnished to the Department in the case entitled "Samuel N. Giancana, Anti-Racketeering."

Since the purpose for placing the wire tap on Rowan's telephone, which is the basis for this investigation of the violation of the Unauthorized Publication or Use of Communications Statute, has not been determined, the full investigation requested in this matter is continuing and copies of reports will be furnished to the Department upon receipt.

In view of the information regarding CIA's attempted utilization of the hoodlum element in connection with anti-Castro activities, CIA has requested that this information be handled on a "need-to-know" basis.

Enclosures (2)

- 1 - Mr. Byron R. White
Deputy Attorney General (Enclosure)
- 1 - Assistant Attorney General
Herbert J. Miller, Jr. (Enclosure)

ENCLOSURE

The Attorney General

May 22, 1961

Director, FBI

ARTHUR JAMES BALLETTI, et al.
UNAUTHORIZED PUBLICATION
OR USE OF COMMUNICATIONS

This case involves an allegation that Arthur James Balletti and another unidentified individual placed a wire tap on the telephone of Dan Rowan, a member of the comedy team of Rowan and Martin, in October, 1960.

The Criminal Division was previously advised that Robert Mahou, after concealing his full connection with this matter, informed that coverage of Rowan was in furtherance of activities of Mahou on behalf of the Central Intelligence Agency (CIA) relative to anti-Castro activities.

Colonel Sheffield Edwards, Director of Security, CIA, furnished the information set forth in the attached memorandum regarding his utilization of Mahou in connection with anti-Castro activities. According to Colonel Edwards Mahou contacted Sam Giancana in connection with this program. Reports of investigation of Giancana have been furnished to the Department in the case entitled "Samuel N. Giancana, Anti-Racketeering."

Since the purpose for placing the wire tap on Rowan's telephone, which is the basis for this investigation of the violation of the Unauthorized Publication or Use of Communications Statute, has not been determined, the full investigation requested in this matter is continuing and copies of reports will be furnished to the Department upon receipt.

In view of the information regarding CIA's attempted utilization of the hoodlum element in connection with anti-Castro activities, CIA has requested that this information be handled on a "need-to-know" basis.

Enclosures (2)

- 1 - Mr. Byron R. White
Deputy Attorney General (Enclosure)
- 1 - Assistant Attorney General
Herbert J. Miller, Jr. (Enclosure)



UNITED STATES DEPARTMENT OF JUSTICE
FEDERAL BUREAU OF INVESTIGATION

In Reply, Please Refer to
File No.

WASHINGTON 25, D. C.

May 22, 1961

ARTHUR JAMES BALLETTI, et al.

On May 3, 1961, Colonel Sheffield Edwards,
Director of Security, Central Intelligence Agency (CIA)
furnished the following information.

Colonel Edwards advised that in connection with CIA's operation against Castro he personally contacted Robert Maheu during the Fall of 1960 for the purpose of using Maheu as a "cut-out" in contacts with Sam Giancana, a known hoodlum in the Chicago area. Colonel Edwards said that since the underworld controlled gambling activities in Cuba under the Batista government, it was assumed that this element would still continue to have sources and contacts in Cuba which perhaps could be utilized successfully in connection with CIA's clandestine efforts against the Castro government. As a result, Maheu's services were solicited as a "cut-out" because of his possible entree into underworld circles. Maheu obtained Sam Giancana's assistance in this regard and according to Edwards, Giancana gave every indication of cooperating through Maheu in attempting to accomplish several clandestine efforts in Cuba. Edwards added that none of Giancana's efforts have materialized to date and that several of the plans still are working and may eventually "pay off."

Colonel Edwards related that he had no direct contact with Giancana; that Giancana's activities were completely "back stopped" by Maheu and that Maheu would frequently report Giancana's action and information to Edwards. No details or methods used by Maheu or Giancana in accomplishing their missions were ever reported to Edwards. Colonel Edwards said that since this is "dirty business" he could not afford to have knowledge of the actions of Maheu and Giancana in pursuit of any mission for CIA. Colonel Edwards added that he has neither given Maheu any instruction to use technical installations of any type nor has the subject of technical installations ever come up between Edwards and Maheu in connection with Giancana's activity.

ENCLOSURE

Colonel Edwards related that Maheu did come to him concerning the arrest in Las Vegas of Balletti for "wire tapping." Maheu cautioned Edwards that the Balletti arrest could cause CIA some embarrassment since Balletti was in Las Vegas attempting to obtain coverage on some "Hollywood people" in connection with Giancana's efforts for CIA. Edwards said that he did not know the facts of the Balletti case and Maheu claims "Balletti went too far" in his efforts to obtain information. Edwards added that he was unaware of any reason for this activity of Maheu or Giancana in Las Vegas and that Giancana's activity in furtherance of the anti-Castro activity was left completely in Maheu's hands.

Colonel Edwards advised that only Mr. Bissell (Deputy Director of Plans, CIA) and two others in CIA were aware of the Giancana - Maheu activity in behalf of CIA's program and that Allen Dulles was completely unaware of Edwards' contact with Maheu in this connection. He added that Mr. Bissell, during his recent briefings of General Taylor and the Attorney General in connection with their inquiries into CIA relating to the Cuban situation, told the Attorney General that some of CIA's associated planning included the use of Giancana and the underworld against Castro.

"Property of FBI
This report and its contents are
loaned to you by the FBI, and
neither it nor its contents are
to be distributed outside the agency
to which loaned."



From

THE ATTORNEY GENERAL

- Deputy Attorney General
- Solicitor General
- Executive Assistant to the Attorney General ...
- Assistant Attorney General, Antitrust
- Assistant Attorney General, Tax
- Assistant Attorney General, Civil
- Assistant Attorney General, Lands
- Assistant Attorney General, Criminal
- Assistant Attorney General, Legal Counsel ...
- Assistant Attorney General, Alien Property ...
- Assistant Attorney General, Internal Security .
- Assistant Attorney General, Civil Rights
- Administrative Assistant Attorney General
- Director, F. B. I.
- Director, Bureau of Prisons
- Commissioner, Immigration and Naturalization
- Pardon Attorney
- Parole Board
- Board of Immigration Appeals
- Director, Public Information
- Records Administration Office

MEMORANDUM

June 3, 1961

Courtney Evans

I hope this will be followed up vigorously.

PEE

Handwritten notes:
 1/21/61
 Bell...
 1-21-1961
 REC-64
 EX-105
 JUN 14 1961

66 JUN 20 1961

236

Handwritten initials: SLA

Memorandum

YH
 Callahan _____
 Conrad _____
 DeLoach _____
 Evans _____
 Malone _____
 Rosen _____
 Sullivan _____
 Tavel _____
 Trotter _____
 Tele. Room _____
 Ingram _____
 Gandy _____
McC

TO : Mr. Belmont *AB* DATE: 6/7/61

FROM : C. A. Evans *✓*

SUBJECT: ARTHUR JAMES BALLETTI, et al
 UNAUTHORIZED PUBLICATION
 OR USE OF COMMUNICATIONS

The Attorney General has returned to the Bureau the original of the Director's memorandum of May 22, 1961, with the comment, "I hope this will be followed up vigorously."

As a matter of background, we are investigating an allegation that Balletti and another unidentified individual placed a wire tap on the telephone of Dan Rowan, a member of the comedy team of Rowan and Martin, in October, 1960. During this investigation we learned that Robert Maheu, a former Bureau agent, alleged that the coverage of Rowan was in furtherance of Maheu's activities in behalf of CIA.

We checked with CIA and ascertained that CIA had used Maheu as an intermediary in contacting Sam Giancana, the notorious Chicago hoodlum. This was in connection with anti-Castro activities. CIA, however, did not give any instructions to Maheu to use any technical installations. In connection with this information received from CIA concerning their attempted utilization of the hoodlum element, CIA requested this information be handled on a "need-to-know" basis.

ACTION BEING TAKEN:

We are conducting a full investigation in this wire tap case requested by the Department and the field has been instructed to press this investigation vigorously. Accordingly, the Attorney General will be orally assured that we are following up vigorously and the results of our investigation will be furnished to the Department promptly.

- 1 - Mr. Rosen
- 1 - Mr. McGowan
- 1 - Mr. Conroy

CAE:mar
 (7)

66 JUN 20 1961

REC-64 *✓*
 EX-102
 13 JUN 14 1961
6-40

FEDERAL BUREAU OF INVESTIGATION

Reporting Office LAS VEGAS	Office of Origin LAS VEGAS	Date 6/14/61	Investigative Period 5/22/61
TITLE OF CASE ARTHUR JAMES BALLETTI; UNKNOWN SUBJECT, aka J. W. Harrison		Report made by [REDACTED] b7c	Typed By nlw
		CHARACTER OF CASE UPUC	

REFERENCE:

^{b7c} Report of SA [REDACTED] dated 5/22/61 at Las Vegas.
Chicago airtel to Bureau, dated 5/23/61.

Miami airtel to Bureau, dated 5/24/61.

Bureau airtel to Las Vegas, dated 6/9/61.

^{b7c} Report of SA [REDACTED] dated 6/6/61 at Washington Field Office.

Los Angeles airtel to Bureau, dated 6/9/61.

Las Vegas airtel to Bureau, dated 6/12/61.

-P-

ADMINISTRATIVE:

As set forth in referenced Las Vegas airtel of 6/12/61, UACB, this matter will be discussed with USA, Las Vegas upon receipt of investigation set forth in Los Angeles

Approved [Signature]	Special Agent In Charge	Do not write in spaces below		
Copies made: 2 - Bureau (139-1201) 1 - USA, Reno 1 - Chicago (139-105) (Info) 1 - Los Angeles (139-775) (Info) 1 - WFO (139-61) (Info) 1 - Miami (139-63) 2 - Las Vegas (139-1)		[REDACTED]		REC-66
		JUN 10 1961		EX-116
		[REDACTED]		

AAC Criminal Division
4 B 6-22-61 EST/alm

EST
REC'D - CIA/STW/21
[Signature]

3 JUN 22 1961

LV 138-1

airtel of 6/9/61.

LEADS:

One copy of this report is being furnished each indicated office for information purposes in the event that additional investigation is requested in an effort to identify unknown subject, aka J. W. HARRISON.

- B* -
COVER PAGE

UNITED STATES DEPARTMENT OF JUSTICE
FEDERAL BUREAU OF INVESTIGATION

Copy to: 1 - USA, Reno

Report of: [REDACTED] b7c
Date: 6/14/61

Office: Las Vegas, Nevada

Field Office File No.: 139-1

Bureau File No.: 139-1201

Title: ARTHUR JAMES BALLETTI; UNKNOWN SUBJECT,
aka J. W. Harrison

Character: UNAUTHORIZED PUBLICATION AND USE OF COMMUNICATIONS

Synopsis: Efforts to locate SAM GIANCANA for interview
unsuccessful. GIANCANA unknown to Subject BALLETTI or
EDWARD L. DU BOIS.

-P-

DETAILS:

By communication dated May 23, 1961, the Chicago Division advised that efforts to locate SAM GIANCANA for interview have been unsuccessful.

By communication dated May 24, 1961, the Miami Division advised that on May 22, 1961, EDWARD L. DU BOIS again advised he had never heard of SAM GIANCANA and that on May 24, Subject BALLETTI advised he had never heard of SAM GIANCANA.

Date April 27, 1961

[redacted] California, advised that they resided at 10214
 [redacted] California, for about two years
 prior to October 1, 1960 when they moved to their present
 residence on [redacted] that they rented the house on
 [redacted] from [redacted] that their telephone
 number at the [redacted] address was [redacted] and that
 they had this telephone disconnected when they left. Their
 current telephone number is [redacted] exhibited
 a rent receipt showing that they paid rent on their present
 residence beginning October 1, 1960.

[redacted] stated that he is employed by [redacted]
 [redacted] Los Angeles, California.

Neither [redacted] nor [redacted] had any recollection
 of receiving any long distance telephone calls from Florida
 during October, 1960 or at any other time. They both stated
 that they are not acquainted with anyone named ROBERT
 MAHEU.

[redacted] recalled that [redacted] has some relatives
 in Florida.

On 4/18/61 at Whittier, California File # Los Angeles 139-77
 by SA [redacted] ter b7C Date dictated 4/21/61

Date April 20, 1961

The records of the [redacted] reflect the following information:

On November 1, 1960 a long distance telephone call was made from telephone number BR 2-4386, which is one of the telephone numbers of the law firm of Cantillon and Cantillon, 9441 Wilshire Boulevard, Beverly Hills, California, to BOB MAHEU, telephone number JE 3-9655, Washington, D. C.

[redacted]

The above information was furnished on a confidential basis and should not be disclosed without the issuance of a subpoena duces tecum to the Pacific Telephone and Telegraph Company, Attention: [redacted] Special Agent in Charge, [redacted] West Seventh Street, Los Angeles, California.

b7C
b7D

On 4/11/61 at Los Angeles, California File # Los Angeles 139-77
by SE [redacted] tgr Date dictated 4/14/61

This document contains neither recommendations nor conclusions of the FBI. It is the property of the FBI and is loaned to your agency; it and its contents are not to be distributed outside your agency.

Date April 20, 1961

The records [redacted]

reflect the following information:

[Large redacted block of text]

b7C
b7D
OS

The above information was furnished on a confidential basis [redacted]

On 4/12/61 at Santa Monica, California File # Los Angeles 139-77
by SE [redacted] /ter Date dictated 4/14/61

This document contains neither recommendations nor conclusions of the FBI. It is the property of the FBI and is loaned to your agency; it and its contents are not to be distributed outside your agency.

FBI

Date: 6/16/61

Transmit the following in PLAIN TEXT
(Type in plain-text-or-code)

Via AIRTEL AIR MAIL
(Priority or Method of Mailing)

TO: DIRECTOR, FBI (139-1201)

FROM: SAC, LAS VEGAS (139-1)

370177

RE: ARTHUR JAMES BALLETTI;
UNKNOWN SUBJECT, aka J. W.
Harrison
UPUC
(OO: Las Vegas)

Handwritten signature

Re Bureau airtel dated 6/14/61 and Las Vegas letter to Bureau, attention FBI Laboratory, 3/28/61.

Referenced Las Vegas letter on 3/28/61, forwarded to the FBI Laboratory, Riviera Hotel, Las Vegas, Nevada, Registration Card No. 192650, bearing the handwriting of J. W. Harrison to Laboratory for comparison with handwriting on Kenilworth Hotel, Bal Harbour, Florida, Registration Card, bearing name of J. A. ROLLINS, which was submitted by Miami on 3/22/61.

The Laboratory is requested to compare handwriting of JOHN ROSELLI, available in Bureau file 92-3267, with the handwriting of above two described hotel registration cards.

Photograph of JOHN ROSELLI will be immediately exhibited at the Riviera Hotel, Las Vegas, Nevada.

P

REC-23

139-1201-56 ab

- 3 - Bureau
- 2 - Los Angeles (139-77) (Info)
(1 92-113)
- 1 - Miami (139-63) (Info)
- 1 - WFO (139-61) (Info)
- 1 - Chicago (139-105) (Info)
- 3 - Las Vegas
(1-92-467)

17 JUN 21 1961

MBP/nl
(11)

EX-113

Handwritten signatures and initials

INDEX LAB FILES

Approved: _____ Sent _____ M Per _____
Special Agent in Charge



FEDERAL BUREAU OF INVESTIGATION
WASHINGTON, D. C.

To: FBI, Las Vegas (139-1)

Date: June 27, 1961

Re: ARTEUR JAMES BALLETTI;
Unsub, aka J. W. HARRISON
UPUC

J. Edgar Hoover
John Edgar Hoover, Director

EX-116

FBI File No.
Lab. No.

REC-123
139-1301-56
D-370177 HW

Examination requested by: Las Vegas

Reference: Airtel 6/16/61

Examination requested: Document

Remarks:

The available known handwriting and hand printing of JOHN ROSELLI are contained in photocopies of Selective Service documents which were forwarded by the Los Angeles Office March 28, 1958. The signatures on fingerprint cards of JOHN ROSELLI were not compared with the handwriting on Q1 and Q2 because the writings involved would not be comparable.

MAILED 31
JUN 27 1961
COMM FBI

Enclosures (2) (2 Lab report)

- 1 - Los Angeles (139-77) Enclosure (Lab report)
- 1 - Miami (139-63) Enclosure (Lab report)
- 1 - Washington Field Office (139-61) Enclosure (Lab report)
- 1 - Chicago (139-106) Enclosure (Lab report)

JUN 30 3 30 PM '61

FBI
REC'D - CIA RIGHTS

son _____
 ions _____
 r _____
 ment _____
 rhan _____
 rad _____
 each _____
 s _____
 e _____
 r _____
 y _____
 yllow _____
 rober _____

JUN 29 1961

RECEIVED
FEDERAL BUREAU OF INVESTIGATION
JUN 29 1961

MAIL ROOM TELETYPE UNIT

J. Edgar Hoover
732

REPORT
of the



FEDERAL BUREAU OF INVESTIGATION
WASHINGTON, D. C.

To: FBI, Las Vegas

Date:

June 27, 1961

Re: ARTHUR JAMES BALLETTI;
Unsub, aka J. W. HARRISON
UPUC

FBI File No.

139-1201

Lab. No.

D-370177 HW

~~XXXXXXXXXX~~ Request received 6/21/61

Request comparison of handwriting of JOHN ROSELLI
with handwriting on submitted hotel registration cards

Result of examination:

The available known handwriting of JOHN ROSELLI is not sufficiently comparable with the handwriting and hand printing on the Riviera Hotel reservation card #192650, Q2, and the Kenilworth Hotel registration card #8009, Q1, to permit an adequate comparison. Consequently, it was not determined definitely whether ROSELLI did or did not prepare the written material on Q1 and Q2.

- Mr. Tolson _____
- Mr. DeLoach _____
- Mr. Mohr _____
- Mr. Bishop _____
- Mr. Casper _____
- Mr. Callahan _____
- Mr. Conrad _____
- Mr. Felt _____
- Mr. Gale _____
- Mr. Rosen _____
- Mr. Sullivan _____
- Mr. Tavel _____
- Mr. Trotter _____
- Tele. Room _____
- Miss Holmes _____
- Miss Gandy _____

TAD: ml (8)

MSV

MAIL ROOM TELETYPE UNIT

70M 5 E 1381

Recorded 6/23/61
NB

FEDERAL BUREAU OF INVESTIGATION
UNITED STATES DEPARTMENT OF JUSTICE

Laboratory Work Sheet

NO LAB FILE

Re: ARTHUR JAMES BAJJETTI;
Unsub, aka J. W. HARRISON
XHEAEXHESS UFUC

File # 139-1201-56
Lab. # D-370177 HW

Examination requested by: Las Vegas (139-1)

6/16/61

Examination requested: Doc.

Date received: 6/21/61

Result of Examination:

Examination by: [REDACTED]

From Capital City Hotel with [unclear]

b7C

Specimens submitted for examination

comparison
Request of Mr. JOHN ROSEMAN, Bufile 92-3267, with [unclear] submitted
hotel registration cards

*Lab. [unclear]
6/21/61
[unclear]*

J A ROLLINS WASHINGTON

97 Q W Garrison 214 W Wall St

San Francisco Calif

98 J A ROLLINS

California

Chicago

2

3

6-22-61

~~CONFIDENTIAL~~

AIRTEL

Classified by 10049

Exempt from GDS, Category 2

Exempt from Declassification 10/11/77

APPROPRIATE AGENCIES AND FIELD OFFICES ADVISED BY ROUTING SLIP(S)

To: SACs, Las Vegas (139-1)
Chicago (139-105)
Los Angeles (139-77)
Miami (139-63)
WFO (139-61)

Declassified
3-25-81 SA

12/11/77
GC/ae
H-5
2100

From: Director, FBI (139-1201)

ARTHUR JAMES BALLETTI;
UNSUB, aka J. W. Harrison
UPUC
OO: Las Vegas
BUDED: 6-29-61

DECLASSIFIED BY SP4-Jm/Koa
ON 3/9/81
CIA Info Declassified per
John E. Bacon 8/27/80

ReCGairtel 5-23-61 and LVrep 5-14-61.

CG immediately advise of further efforts to interview Giancana relative to this case and if available and not already done, interview him and surep. Include in urrep efforts to locate and observations of his associates regarding Giancana's indicated evasive tactics in avoiding interview by FBI Agents as set forth in urairtel 5-23-61.

Complete Giancana phase and surep by 6-29-61.

~~CONFIDENTIAL~~

Offices having outstanding leads in Roselli phase, complete and sureps by 6-29-61.

EJM:vhm
(12)

MAILED 9
JUN 22 1961
COMM-FBI

NOTE:

REC-36
139-7501-5
EX-107
JUN 23 1961

Tolson _____
Belmont _____
Mohr _____
Callahan _____
Conrad _____
DeLoach _____
Evans _____
Malone _____
Rosen _____
Sullivan _____
Tavel _____
Trotter _____
Tele. Room _____
Ingram _____
Gandy _____

Case involves wire tap placed on phone of Dan Rowan, member of comedy team of Rowan and Martin. Subject Balletti has stated that tap was placed by J. W. Harrison who was not further known to him. Robert Maheu, former BuAgent, stated he ordered coverage of Rowan on behalf of CIA's anti-Castro activities but did not order telephone tap. Present developments indicate Sam Giancana and possibly John Roselli (both under investigation as top hoodlums in CG and LA, respectively) may be involved. All aspects of case being vigorously pursued to resolve matter.

50 JUN 28 1961

Sign

FBI

Date: 6/28/61

Mr. Tolson	_____
Mr. Belmont	_____
Mr. Mohr	_____
Mr. Callahan	_____
Mr. Conrad	_____
Mr. DeLoach	_____
Mr. Evans	_____
Mr. Malone	_____
Mr. Rosen	_____
Mr. Sullivan	_____
Mr. Tavel	_____
Mr. Trotter	_____
Tele. Room	_____
Mr. Ingram	_____
Miss Gandy	_____

Transmit the following in PLAIN TEXT
(Type in plain text or code)

Via TELETYPE URGENT
(Priority or Method of Mailing)

TO: DIRECTOR (139-1201) AND SAC, LOS ANGELES (139-77)

FROM: SAC, WFO (139-61)

ARTHUR JAMES BALLETTI, ET AL, UPUC, OO LAS VEGAS. RELAAIRTEL
 JUNE NINE LAST. EFFORTS TO LOCATE ROBERT MAHEU, WASH., DC,
 NEGATIVE. MAHEUS OFFICE ADVISED INSTANT DATE THAT MAHEU
 WILL BE IN LOS ANGELES UNTIL LATTER PART OF WEEK AT
 GRANITE TWO DASH ONE TWO ONE ONE. LOS ANGELES HANDLE WFO
 LEAD REFERENCED AIRTEL. RUC.

- 2 - Bureau
- 2 - Teletype Unit
- 1 - WFO

CWB:khc
(5)

REC-68

139-1201-56

JUN 29 1961

50 JUL 5 1961 *M W J*
 Approved: _____
 Special Agent in Charge

Sent _____ M Per _____

FEDERAL BUREAU OF INVESTIGATION

Reporting Office CHICAGO	Office of Origin LAS VEGAS	Date 6/28/61	Investigative Period 5/18-6/26/61
TITLE OF CASE ARTHUR JAMES BALLETTI; UNSUB, aka J. W. Harrison		Report made by [REDACTED] b7c	Typed By: FMS
		CHARACTER OF CASE UPUC	

Synopsis:

REFERENCES: Los Angeles airtel to the Bureau dated 6/9/61.
b7c Report of SA [REDACTED] dated 6/14/61 at Las Vegas.
 Bureau airtel to Las Vegas, Chicago, Los Angeles,
 Miami and WFO dated 6/22/61.

- RUC -

LEADS

Information copies of this report are being furnished to each office indicated in view of extensive investigation being conducted therein.

ADMINISTRATIVE

[REDACTED] advised SA [REDACTED]

JUN 29 11 20 AM '61
 RECEIVED
 CHICAGO OFFICE

*b2
b7c
b7D*

Approved <i>[Signature]</i>	Special Agent In Charge	Do not write in spaces below	
Copies made: (2) - Bureau (139-1201) 3 - Las Vegas (139-1) (1 - USA, Reno) 1 - Los Angeles (139-77) (Info) 1 - Miami (139-63) (Info) 1 - WFO (139-61) (Info) 1 - Chicago (139-105)		139-1201-27	REC-8
		17 JUN 30 1961	

*cc: AAG [REDACTED] Division
 FROM 6-29-61*

COVER PAGE

EBI
 REC'D - CIA WICHIA

36

Property of FBI. This report is loaned to you by the FBI, and neither it nor its contents are to be distributed outside the agency to which loaned.

CG 139-105

b7c

b7c
b7D he had been interviewed by SA [REDACTED] of the FBI and that the FBI was attempting to interview SAM GIANCANA. [REDACTED]

[REDACTED] as a result of this, GIANCANA immediately "made himself scarce" so that his movements in Chicago and out of Chicago are conducted on a surreptitious manner.

COVER PAGE

- B* -

UNITED STATES DEPARTMENT OF JUSTICE
FEDERAL BUREAU OF INVESTIGATION

Copy to: 1 - USA, Reno

Report of: SA [REDACTED] b7c
Date: June 28, 1961

Office: Chicago, Illinois

Field Office File No.: 139-105

Bureau File No.: 139-1201

Title: ARTHUR JAMES BALLETTI;
UNKNOWN SUBJECT, aka
J. W. Harrison

Character: UNAUTHORIZED PUBLICATION AND USE OF COMMUNICATIONS

Synopsis: Efforts to locate GIANCANA unsuccessful to date.
ANTHONY V. CHAMPAGNE, Attorney for GIANCANA,
telephonically advised his client is not available
for interview. Identification of telephone number
SU 7-7200 set forth.

- RUC -

CG 139-105

DETAILS:

b7C On May 18, 1961, Mrs. MARIE PERNO, 1147 South Wenonah Street, Oak Park, Illinois, advised SA [REDACTED] that she is the wife of JAMES PERNO and is the niece of ANGELINE GIANCANA, the late wife of SAM GIANCANA. Mrs. PERNO advised that she and her husband have been residing in the GIANCANA residence since the death of GIANCANA's wife in 1954.

She advised that SAM GIANCANA rarely comes to this residence and when he makes his appearances, they are very brief and unannounced. She stated that GIANCANA was not, at that time, in the Chicago area to her knowledge and was not aware of his whereabouts.

b7C She was asked to contact GIANCANA and to advise him that SA [REDACTED] was desirous of interviewing him.

b7C b7D On May 19, 1961, ANTHONY V. CHAMPAGNE, Attorney, 1 North La Salle Street, Chicago, Illinois, telephonically advised SA [REDACTED] that his client, SAM GIANCANA, had contacted him and advised him to relate a message to SA [REDACTED] to the effect that he, GIANCANA, did not desire to be interviewed on any matter. Mr. CHAMPAGNE said that he did not feel that it was within his purview to attempt to persuade GIANCANA to make himself available for an interview.

b7C On [REDACTED] Illinois, was contacted by SAs [REDACTED] and [REDACTED] at which time [REDACTED] advised that GIANCANA was "out of town" and refused to disclose his whereabouts. [REDACTED] would neither confirm nor deny that he was closely associated with GIANCANA and that GIANCANA utilized him [REDACTED]

[REDACTED] was recontacted on May 31, 1961 by SAs [REDACTED] and [REDACTED], at which time he advised that he had contacted GIANCANA and advised him of the fact that the

CG 139-105

Federal Bureau of Investigation was interested in interviewing him and said that GIANCANA had told him that he was not interested in being interviewed.

The records of the Illinois Bell Telephone Company, Chicago, Illinois, as checked on June 13, 1961, reveal that telephone number SU 7-7200 is listed to the Ambassador Hotels, Chicago, Illinois.

FEDERAL BUREAU OF INVESTIGATION

Reporting Office MIAMI	Office of Origin LAS VEGAS	Date 6/26/61	Investigative Period 6/14-20/61
TITLE OF CASE ARTHUR JAMES BALLETTI; UNKNOWN SUBJECT, aka J W. Harrison		Report made by [REDACTED] b7C	Typed By: :ush
		CHARACTER OF CASE UPUC	

~~SECRET~~

REFERENCES:

Report of SA **[REDACTED]** 6/9/61,
at Miami,
Los Angeles airtel to Bureau, 6/9/61,
Bureau airtel, 6/14/61, **b7C**
Report of SA **[REDACTED]** 6/14/61,
at Las Vegas.

- RUC -

- A* -
(COVER PAGE)

Approved <i>[Signature]</i>	Special Agent In Charge	Do not write in spaces below	
Copies made: 2 - Bureau (139-1201) 3 - Las Vegas (139-1) (1 - USA, Reno) 1 - Miami (139-63)		139-1201-10	REC-8
		17 JUN 30 1961	
		JUN 30 1 10 PM '61	
		FBI REC'D - CIA BUREAU	

cc: AAG (1) - [unclear] Division
Form 6-24 6/26/61 E. J. [unclear]

~~DISSEMINATION RESTRICTED TO JUSTICE DEPARTMENT~~

30 JUL 11 1961

UNITED STATES DEPARTMENT OF JUSTICE
FEDERAL BUREAU OF INVESTIGATION

Copy to: 1 - USA, Reno

Report of: [REDACTED] 107C

Office: Miami, Florida

Date: June 26, 1961

Field Office File No.: 139-63

Bureau File No.: 139-1201

Title: ARTHUR JAMES BALLETTI;
UNKNOWN SUBJECT, aka,
J. W. Harrison

Character: UNAUTHORIZED PUBLICATION AND USE OF COMMUNICATIONS

Synopsis:

EDWARD DUBOIS and subject BALLETTI, after viewing photo of JOHN ROSELLI, FBI #3339986, said they did not recognize him and they are sure that they have not been in contact with him in connection with their investigation at Las Vegas, Nevada. ROSELLI's photo exhibited to employees Kenilworth Hotel, Miami Beach; one employee said resembles person she recalls as J. A. ROLLINS, but she was unable to furnish a physical description of ROLLINS. Telephone number UN 4-2922, Miami Beach, Florida, issued to the apartment of a singer employed at the Carillon Hotel, Miami Beach, who gave Las Vegas as her permanent address.

- RUC -

DETAILS:

Date 6/23/61

ARTHUR JAMES BALLETTI was interviewed at the office of Investigators, Incorporated, Ainsley Building, Miami, Florida. He was exhibited a photograph of JOHN ROSELLI, FBI #3339986, and after studying this photo, said he could not recall ever seeing that man. He said he was positive that he had not seen that person in connection with investigation he conducted in Las Vegas, Nevada, during the Fall of 1960. He also advised that this person was not the person he knew of as J. W. HARRISON.

On 6/20/61 at Miami, Florida File # MI 139-63
by b7c Special Agents [redacted] and [redacted] Date dictated 6/21/61

This document contains neither recommendations nor conclusions of the FBI. It is the property of the FBI and is loaned to your agency; it and its contents are not to be distributed outside your agency.

Date 6/23/61

b7C Photograph of JOHN ROSELLI, FBI #3339986, was exhibited to EDWARD DUBOIS by ARTHUR BALLETTI in the presence of Special Agents [REDACTED] and [REDACTED]. He said the photo appeared somewhat familiar although he could not recall where he had seen the person and mentioned that he looked like a "movie character" and that might be the reason why the photo was familiar.

He said he was positive that he had not seen this person in connection with investigation his firm conducted at Las Vegas, Nevada, in the Fall, 1960.

On 6/20/61 at Miami, Florida File # MI 139-63

b7C by Special Agents [REDACTED] and [REDACTED]

by [REDACTED] Date dictated 6/21/61

This document contains neither recommendations nor conclusions of the FBI. It is the property of the FBI and is loaned to your agency; it and its contents are not to be distributed outside your agency.

Date 6/23/61

37C [REDACTED] Kenilworth Hotel, Miami Beach, Florida, was exhibited a photograph of JOHN ROSELLI, FBI #3339986, on June 20, 1961. She advised that person looked somewhat familiar to her. After the names ROBERT A. MAHEU and J. A. ROLLINS were mentioned to her, she said she believed this was a photograph of ROLLINS. She said she felt quite sure of this identification but she could not make a positive identification without seeing this man in person. She was asked to give a physical description of ROLLINS as she recalled him and stated she was unable to do so.

On 6/20/61 at Miami Beach, Florida File # MI 139-63

by 37C Special Agents [REDACTED] and [REDACTED] Date dictated 6/21/61

This document contains neither recommendations nor conclusions of the FBI. It is the property of the FBI and is loaned to your agency; it and its contents are not to be distributed outside your agency.

MM 139-63

b7C [REDACTED] Kenilworth Hotel,
Miami Beach, Florida, advised he clearly recalls ROBERT A.
MAHEU as being a guest at that hotel prior to the Presidential
elections in November, 1960. He also said he recalls MAHEU
being accompanied by a Mr. J. A. ROLLINS during his stay at
that time. He said he could not recall anything about ROLLINS
other than the name and he was unable to describe ROLLINS.

He was exhibited a photograph of JOHN ROSELLI,
FBI #3339986, and said he could not recall ever seeing that
person and was unable to say whether or not it might be the
person named J. A. ROLLINS.

Date 6/23/61

The records of

[REDACTED]

b7C
b7D
OS

The above information was furnished on a confidential basis.

[REDACTED]

On 6/15/61 at Miami, Florida File # 151 133-63
by Special Agent [REDACTED] Date dictated 6/21/61

This document contains neither recommendations nor conclusions of the FBI. It is the property of the FBI and is loaned to your agency; it and its contents are not to be distributed outside your agency.

MM 139-63.

The records of the [REDACTED] as checked on June 20, 1961, did not contain any information identifiable with [REDACTED]

The [REDACTED] of the [REDACTED] as checked on June 20, 1961, show a [REDACTED] for [REDACTED] Florida. This card shows [REDACTED] as a white [REDACTED]. She is 5' 2" tall, weighs 110 pounds, and has blue eyes and black hair. [REDACTED]

[REDACTED] She was in December, 1960, employed as a [REDACTED] Florida. She gave her Northern address as [REDACTED] Nevada, and her next of kin is shown as her father, [REDACTED]

FEDERAL BUREAU OF INVESTIGATION

Reporting Office LAS VEGAS	Office of Origin LAS VEGAS	Date 6/29/61	Investigative Period 6/17/61 - 6/29/61
TITLE OF CASE ARTHUR JAMES BALLETTI; UNKNOWN SUBJECT, aka., J. W. Harrison		Report made by [REDACTED] b7C	Typed By: bsj
		CHARACTER OF CASE UPUC	

313

b7C

REFERENCES: Report of SA [REDACTED] dated 6/14/61, at Las Vegas.

Bureau airtel, dated 6/14/61.

Las Vegas letter to Bureau, dated 6/16/61.

Bureau letter to Las Vegas, dated 6/27/61.

-P-

LEADS

LOS ANGELES DIVISION (INFORMATION)

One copy of this report is being furnished to Los Angeles in view of information relative to JOHN ROSELLI, aka.

LAS VEGAS DIVISION

AT LAS VEGAS, NEVADA

Approved <i>[Signature]</i> Special Agent In Charge	Do not write in spaces below		
Copies made: ② - Bureau (139-1201) 1 - USA, Reno 1 - Los Angeles (Info) 2 - Las Vegas (139-1)	139	61	REC-47
	17 JUL 3 1961		EX-107
	REC'D - CIV RIGHTS		

1cc: AAG Criminal Division
Form 6-91 6-7-61

[Handwritten signatures and stamps]

6. JUL 17 1961

LV 139-1

UACB, this matter will be discussed with USA, Las Vegas, upon receipt of results of investigation presently outstanding.

- B* -

COVER PAGE

UNITED STATES DEPARTMENT OF JUSTICE
FEDERAL BUREAU OF INVESTIGATION

Copy to: 1 - USA, Reno

Report of: [REDACTED] b7c

Office: Las Vegas, Nevada

Date: 6/29/61

Field Office File No.: 139-1

Bureau File No.: 139-1201

Title: ARTHUR JAMES BALLETTI;
UNKNOWN SUBJECT, aka.,
J. W. Harrison

Character: UNAUTHORIZED PUBLICATION OR USE OF COMMUNICATIONS

Synopsis: Investigation, Las Vegas, unable to identify JOHN ROSELLI, aka., as being identical with UNSUB, aka., J. W. HARRISON. FBI Laboratory unable to determine whether JOHN ROSELLI did or did not prepare writing on Riviera and Kenilworth Hotel.

-P-

DETAILS: AT LAS VEGAS, NEVADA

Date 6/23/61

b7C

[REDACTED] Riviera Hotel advised that he did not recall having observed an individual, using the name J. W. HARRISON, who checked into the Riviera Hotel on October 26, 1960, and was assigned to room 333, but was later moved to room 331.

b7C

[REDACTED] said that he knows JOHN ROSELLI by sight, and that so far as he knew, ROSELLI had never stayed at that hotel. He feels sure ROSELLI was not individual who checked into the hotel on October 26, 1960, using name of J. W. HARRISON.

On 6/17/61 at Las Vegas, Nevada File # Las Vegas 139-1

b7C
by SA's [REDACTED] & [REDACTED] /CRW Date dictated 6/20/61

Date 6/27/61

b7L [redacted] advised [redacted] b7C
that he is no longer employed at the Riviera Hotel.
[redacted] again advised that he does not think he would know the individuals who checked into the Riviera Hotel on or about October 26, 1960, using the names of ARTHUR BALLETTI and J. W. HARRISON.

b7C Seven photographs, including the photographs of JOHN ROSELLI, were exhibited to [redacted] and he advised that he could not recall having observed any of the individuals before and could not identify any of them as being identical with the individuals who checked into the Riviera Hotel using the names of BALLETTI or HARRISON.

On 6/21/61 at Las Vegas, Nevada File # Las Vegas 139-1
by SA [redacted] /mla Date dictated 6/26/61

This document contains neither recommendations nor conclusions of the FBI. It is the property of the FBI and is loaned to your agency; it and its contents are not to be distributed outside your agency.

LV 139-1

By communication, dated June 16, 1961, the Las Vegas Division requested the FBI Laboratory to compare the handwriting of JOHN ROSELLI, of Los Angeles, California, with the handwriting of UNKNOWN SUBJECT, also known as J. W. HARRISON.

By communication, dated June 27, 1961, the FBI Laboratory advised that the available known handwriting of JOHN ROSELLI is not sufficiently comparable with the handwriting and hand printing on the Riviera Hotel Registration Card No. 8009, Q1, to permit an adequate comparison. Consequently, it was not determined definitely whether ROSELLI did or did not prepare the written material on Q1 and Q2.

FEDERAL BUREAU OF INVESTIGATION

Reporting Office LOS ANGELES	Office of Origin LAS VEGAS	Date 6/30/61	Investigative Period 6/29/61
TITLE OF CASE ARTHUR JAMES BALLETTI; UNKNOWN SUBJECT, aka J. W. Harrison		Report made by [REDACTED]	Typed By: cey
		CHARACTER OF CASE UPUC	

REFERENCES: Los Angeles airtel to Bureau dated 6/9/61.
 Bureau airtel to Las Vegas, Chicago, Los Angeles,
 Miami, and Washington Field dated 6/22/61.
 Washington Field teletype to Bureau and Los
 Angeles dated 6/28/61.
 Los Angeles teletype to Bureau and Las Vegas dated
 6/29/61.

- RUC -

ADMINISTRATIVE

Information copies of this report are being furnished
 Chicago, Miami, and Washington Field since results in this
 report may affect investigation being conducted by these
 offices.

**ALL INFORMATION CONTAINED
 HEREIN IS UNCLASSIFIED**
 DATE 3/9/81 BY SP4 Jm/Kec

- A* -
COVER PAGE

Approved <i>[Signature]</i>	Special Agent in Charge	Do not write in spaces below		
Copies made 2 - Bureau (139-1201) 3 - Las Vegas (139-1) (1 - USA, Reno) 1 - Chicago (139-105) (Info) 1 - Miami (139-63) (Info) 1 - Washington Field (139-61) (Info) 3 - Los Angeles (139-77) (1 - 92-113)		139-1201-	62	REG-72 EX-116
		JUL 5 1961		

1cc: AAG Criminal Division
 Form 6-94 *[Signature]* 7-10-61

Vairtel LA 7-10-61 Eym/ly

STAT. SECT. FBI
REC'D - CIV. RIGHTS

UNITED STATES DEPARTMENT OF JUSTICE
FEDERAL BUREAU OF INVESTIGATION

~~CONFIDENTIAL~~

Copy to: 1 - USA, Reno

Report of: SA [redacted]
Date: June 30, 1961

~~TOP SECRET~~

Office: LOS ANGELES

Field Office File No.: 139-77

Bureau File No.: 139-1201

Title: ARTHUR JAMES BALLETTI;
UNKNOWN SUBJECT, aka J. W. Harrison

Character: UNAUTHORIZED PUBLICATION OR USE OF COMMUNICATIONS

Synopsis: ROBERT MAHEU admitted JOHN ROSELLI is "JOHNNY" through whom he made contact with SAM GIANCANA and that he discussed plan to wire ROWAN's room with ROSELLI before it was done. stated would stick with explanation previously given and added would not have ordered this done except for his connection with CIA. ROSELLI not located at Los angeles apartment. (u)

- RUC -

DETAILS

DECLASSIFIED BY SP4 *[signature]*
ON 3/9/81 *[signature]* 22,330
*CIA info declassified per
John E. Bacon 8/27/80

Classified by *9049*
Exempt from automatic downgrading and
declassification *[initials]*

~~CONFIDENTIAL~~
[Handwritten notes and signatures]

~~CONFIDENTIAL~~

~~TOP SECRET~~

Date 6/30/61

ROBERT MAHEU was interviewed at the Bel-Air Hotel, 701 Stone Canyon Road, West Los Angeles, California.

MAHEU was questioned regarding the identity of JOHNNY referred to in a previous interview as the person through whom he had made contact with SAM GIANCANA. MAHEU declined to name the individual but agreed to verify this person's identity if the agents named him. The name JOHN ROSELLI was given to MAHEU and he admitted that ROSELLI was the "JOHNNY" referred to and that ROSELLI was also identical to J. A. ROLLINS who registered with him at the Kenilworth Hotel in Miami Beach, Florida, in October, 1960. U

MAHEU admitted that he had discussed his plan to wire DAN ROWAN's room at the Riviera Hotel, Las Vegas, Nevada, with ROSELLI prior to ordering that this be done. U

It was pointed out to MAHEU that the explanation he gave in a previous interview for wiring ROWAN's room did not appear logical and was far removed from the purpose for which he was hired by the Central Intelligence Agency (CIA). He said he would stick to the explanation previously given and wished to add that he would never have ordered ROWAN's room wired except for his connection with CIA. (u)

- 2 -

~~CONFIDENTIAL~~

On 6/29/61 at West Los Angeles, California File # Los Angeles 139-77

by SA's [REDACTED] & [REDACTED]/cey Date dictated 6/30/61

LA 139-77

~~TOP SECRET~~

Efforts were made to locate JOHN ROSELLI for interview at his Los Angeles apartment; 1251 North Crescent Heights Boulevard, on June 29, 1961, with negative results. ✓

~~CONFIDENTIAL~~

~~TOP SECRET~~

- 3* -

~~TOP SECRET~~

7/10/61

AIRTEL

low

To: SAC, Los Angeles (139-77)
From: Director, FBI (139-1201) - 62
EX-107 *REC-20*

ARTHUR JAMES BALLETTI
UNKNOWN SUBJECT, aka.,
J. W. Harrison
UPUC

Reurep 6/30/61.

It is not clear whether Maheu's admission that he ordered Rowan's room wired included both the microphone installation and the telephone tap.

Clarify and surep.

ALL INFORMATION CONTAINED
HEREIN IS UNCLASSIFIED *7050029330*
DATE 3/9/81 BY SP4-jm/ka

MAILED 2
JUL 10 1961
COMM-FBI

cc/gmc

- Tolson _____
- Belmont _____
- Mohr _____
- Callahan _____
- Conrad _____
- DeLoach _____ (4)
- Evans _____
- Malone _____
- Rosen _____
- Sullivan _____
- Tavel _____
- Trotter _____
- Tele. Room _____
- Ingram _____
- Gandy _____

EJM:dsj

clw

MAIL ROOM TELETYPE UNIT

SP4

56 JUL 14 1961

DECODED COPY

- Tolson _____
- Belmont _____
- Mohr _____
- Callahan _____
- Conrad _____
- DeLoach _____
- Evans _____
- Malone _____
- Rosen _____
- Sullivan _____
- Tavel _____
- Trotter _____
- Tele. Room _____
- Ingram _____
- Gandy _____

Radio

Teletype

URGENT 6-30-61

TO DIRECTOR AND SAC LAS VEGAS

FROM SAC LOS ANGELES 300246

~~CONFIDENTIAL~~

ARTHUR JAMES BALLETTI, ET AL, UPUC. OO LAS VEGAS. RE WASHINGTON FIELD TELETYPE TO DIRECTOR AND LOS ANGELES JUNE 28 LAST. ROBERT MAHEU LOCATED AND INTERVIEWED JUNE 29, IDENTIFIED JOHN ROSELLI AS JOHNNY THROUGH WHOM HE MADE ORIGINAL CONTACT WITH GIANCANA AND WHO REGISTERED WITH HIM AT KENILWORTH HOTEL AT MIAMI BEACH, FLORIDA, UNDER NAME J.A. ROLLINS. CLAIMS MET ROSELLI TWO YEARS AGO THROUGH HERMAN SPITZEL. ADMITTED HE DISCUSSED PLANS TO WIRE DAN ROWAN'S ROOM WITH ROSELLI BEFORE ORDERING IT DONE. STATED HE WOULD STICK TO EXPLANATION PREVIOUSLY GIVEN AND WOULD NOT HAVE ORDERED INSTALLATION IF HAD NOT BEEN WORKING FOR CIA. ROSELLI NOT AT LOS ANGELES APARTMENT AND BELIEVED TO BE IN LAS VEGAS. REPORT FOLLOWS.

RECEIVED:

2:40 AM RADIO

2:54 AM CODING UNIT

ECD

~~CONFIDENTIAL~~

DECLASSIFIED BY *SP4 Jm/Kca*
ON *3/9/81* *20742 22,330*

* CIA Info declassified per
John E. Moran 8/27/80

Memo Room to Belmont
6/30/61 ESM/whm

Classified by _____
Exempt from GDS, Category _____
Date of Declassification Indefinite

EX 100

REC-6

139-1201-63

JUN 30 7 1961

Airtel to LV, LA, MM WFO
7/5/61
ESM/whm *REC'D - CIA KICHLR*

67 JUL 11 1961

UNITED STATES GOVERNMENT

Memorandum

DECLASSIFIED BY *SP4-jms/KCA*
ON *3/9/81* *632822,330*
per John C. Bacon
8/27/80

- Tolson _____
- Belmont _____
- Mohr _____
- Callahan _____
- Conrad _____
- DeLoach _____
- Evans _____
- Malone _____
- Rosen _____
- Sullivan _____
- Tavel _____
- Trotter _____
- Tele. Room _____
- Ingram _____
- Gandy _____

TO : Mr. Belmont **CIA Info Declassified* DATE: June 30, 1961

FROM : A. Rosen

CONFIDENTIAL

SUBJECT: ARTHUR JAMES BALLETTI, et al.
UNAUTHORIZED PUBLICATION OR USE
OF COMMUNICATIONS

Classified by *6049*
Exempt from GDS
Date of Declassification *12/1/80*

This case involves a wire tap placed on the telephone of Dan Rowan of the comedy team of Rowan and Martin by Arthur James Balletti and one J. W. Harrison, not further identified. Balletti is employed by Edward DuBois, a former Bureau Agent who runs a private investigating agency in Miami, Florida. Balletti admits to having been assigned to surveil Rowan in Las Vegas, Nevada, and was accompanied by J. W. Harrison, not further known to him who was supplied by Robert Maheu, another former Bureau Agent. Dan Rowan is reportedly engaged to Phyllis McGuire of the McGuire Sisters trio, who is also reportedly a girlfriend of Sam Giancana who is under investigation by the Chicago Office as a top hoodlum.

Maheu has claimed that the coverage of Rowan was put on in behalf of Central Intelligence Agency's (CIA) efforts to obtain intelligence information in Cuba through the hoodlum element, including Sam Giancana, which has had interests there. Maheu advised that he was put in contact with Giancana in connection with these intelligence activities through an individual known only to him as "Johnny." Colonel Sheffield Edwards, Director of Security, CIA, advised that Maheu was used as an intermediary with Sam Giancana relative to CIA's anti-Castro activities. Colonel Edwards stated that since this was "dirty business" CIA could not be knowledgeable of Maheu's techniques and therefore he had no information as to whether a telephone tap was utilized in this matter.

CONFIDENTIAL

CURRENT DEVELOPMENTS

EX 100

REC-6

157-1216-64

Maheu has now advised that the "Johnny" through whom he made original contact with Giancana, is John Roselli, who is under investigation as a top hoodlum by the Los Angeles Office and who registered with him at the Kenilworth Hotel at Miami Beach, Florida, under the name J. A. Rollins at about the time

- 1 - Mr. Evans
- 1 - Liaison Section

EJM:vhm
(8)

copy to MR. TOLSON

6-9

Memorandum to Mr. Belmont

Balletti proceeded to Las Vegas to surveil ~~Rowan~~. Balletti, Maheu and Dubois have continually denied knowing the identity of J. W. Harrison and other investigation to date has been unfruitful in this regard. It is possible that he is identical with Roselli. U

Maheu admits he discussed plans to wire ~~Rowan's~~ room with Roselli before ordering that it be done. He stated he would stick to his explanation previously given and would not have ordered the installation if he had not been working for CIA. Giancana is taking evasive action to avoid interview and his attorney has stated Giancana would not talk to FBI Agents. X(u)

ACTION

The field is locating Roselli to interview him. Investigation is being vigorously pressed to ascertain the identity of J. W. Harrison and determine the full implication of Maheu, Giancana, Roselli and the other subjects in this case. U

Handwritten signatures and notes:
Egan
R
J.M.
Chalk
Q
V. Keene
We should vigorously press this.
G

7-5-61

Airtel

To: SACs, Las Vegas (139-1)
Los Angeles (139-77)
Miami (139-63)
WFO (139-61)

EX 100

REC-6

139-201-64

From: Director, FBI (139-1182)

ARTHUR JAMES BALLETTI, et al.
UPUC

Re LA radiogram dated 6-30-61.

If not already done, Roselli should be immediately located and thoroughly interviewed for full details of his knowledge of this matter and appropriate offices advised in the event re-interviews with other subjects and suspects are indicated as a result of information furnished by Maheu and Roselli.

This matter must be vigorously pressed and completed and reports submitted to reach Bureau by 7-12-61.

EJM:vhm
(11)

1 - Mr. Staffeld (Room 4708)

EM/gac

- Tolson _____
- Belmont _____
- Mohr _____
- Callahan _____
- Conrad _____
- DeLoach _____
- Egan _____
- Malone _____
- Rosen _____
- Sullivan _____
- Tavel _____
- Trotter _____
- Tele. Room _____
- Ingram _____
- Gandy _____

MAILED 19
JUL 5 - 1961
COMM-FBI

RECEIVED
JUL 5 4 05 PM '61
FBI

ah

am

MAIL ROOM TELETYPE UNIT

03 JUL 11 1961

ECODED COPY

- Tolson _____
- Belmont _____
- Mohr _____
- Callahan _____
- Conrad _____
- DeLoach _____
- Evans _____
- Malone _____
- Rosen _____
- Sullivan _____
- Trotter _____
- Tele. Room _____
- Ingram _____
- Gandy _____

Radio

Teletype

L. E. Callahan

URGENT 7-6-61 4:42 PM PDST RHK

TO DIRECTOR AND SAC LOS ANGELES

FROM SAC LAS VEGAS 062327

RE ARTHUR JAMES BALLETTI, ET AL. UPUC. RE LOS ANGELES RADIOGRAM JUNE 29. NUMEROUS EFFORTS TO LOCATE JOHN ROSELLI FOR INTERVIEW NON PRODUCTIVE.

*b2
b7D*

ROSELLI WAS AT APARTMENT BUT WAS LEAVING FOR LOS ANGELES. IMMEDIATE EFFORT TO LOCATE NEGATIVE. LOS ANGELES LOCATE ROSELLI AT HIS APARTMENT AND INTERVIEW.

RECEIVED: 7:47 PM TELETYPE

7:51 PM CODING UNIT MN

am

157-1201-65

REC-15

JUL 11 1961

b-epm

177
66 JUL 17 1961

FBI
REC.D - CIA WIC18

7/11/61

DECLASSIFIED BY SP4 Gunkel
ON 3/9/81 FOIPA # 22,330
CIA Info declassified per
John E. Bacon 8/27/80

AIRTEL

APPROPRIATE AGENCIES
AND FIELD OFFICES
ADVISED BY SLIP(S)
DATE 3-25-81

To: SACs, Las Vegas (139-1)
Los Angeles (139-77)
Miami (139-63)
Washington Field (139-61)
Chicago (139-105)

Classified by 1649
Exempt from GDS, Category 2
Date of Declassification Indefinite

From: Director, FBI (139-1201)

ARTHUR JAMES BALLETTI, et al.
UPUC
OO: Las Vegas

~~CONFIDENTIAL~~ 12/11/77 pclass

ReLArep 6/30/61. u

~~CONFIDENTIAL~~

In view of Maheu's admission that he ordered wiring of Rovan's room, Los Angeles should thoroughly interview him for the full details as to Roselli's role in the matter, how the plan was conceived and implemented, including identities of personnel involved. You should resolve the identity of J. W. Harrison and ascertain if DuBois and Balletti's story of how Balletti was supplied by DuBois and Harrison supplied by Maheu is substantiated by Maheu. u

The interview of Maheu should be thorough, searching and of such a nature as to resolve the complete planning and implementation of the wire tap and the implication of each of the subjects and suspects in this case. This interview must be conducted immediately and leads set out to other offices to resolve any questions or discrepancies noted on the basis of prior information developed. u EX-116

REC-74 139-1201-66

Based on the results of the above interview of Maheu, Los Angeles should attempt to reinterview Roselli and JUL 12 1961 indicated, Miami should thoroughly reinterview Balletti and DuBois. u

- Tolson _____
- Belmont _____
- Mohr _____
- Callahan _____
- Conrad _____
- DeLoach _____
- Evans _____
- Malone _____
- Rosen _____
- Sullivan _____
- Tavel _____
- Trotter _____
- Tele. Room _____

1 cc me and Andrews

EJM: aec/10

(12)

SEE NOTE PAGE 2

66 JUL 17 1961 TELETYPE UNIT

MAILED 6
JUL 11 1961
COMM-FBI

~~CONFIDENTIAL~~ [Handwritten signatures and initials]

Airtel to SACs, LV, LA, MM, WFO and CG
Re: Arthur James Balletti, et al.

Chicago should advise if Giancana has changed his attitude and is making himself available for interview and, if so, thoroughly interview him relative to this matter. u

This matter must be vigorously pressed to resolve any questions, results of interview with Maheu submitted immediately and leads developed from this interview completed and reports submitted within ten days of receipt of this airtel. u

NOTE:

Case involves wire tap placed on phone of Dan Rowan, member of comedy team of Rowan and Martin and boy friend of Phyllis McGuire, songstress. Subject Balletti has stated tap placed by J. W. Harrison who was not further known to him. Robert Maheu, former BuAgent previously stated he ordered coverage of Rowan on behalf of CIA's anti-Castro activities but did not order phone tap. Now admits authorizing wiring of Rowan's room and discussed with John Roselli, top hoodlum, LA. Roselli on interview only admits knowing Maheu but refused to give any other information. Investigation indicated Sam Giancana and John Roselli (both under investigation as top hoodlums in CG and LA, respectively) were possibly involved. ~~XXXX~~ Investigation being vigorously pressed to ascertain Maheu's, Giancana's and Roselli's and other subjects' full implication in this matter. (u)

~~CONFIDENTIAL~~

Case involves wire tap placed on phone of Dan Rowan, member of comedy team of Rowan and Martin and boy friend of Phyllis McGuire, songstress. Subject Balletti has stated that tap was placed by J. W. Harrison who was not further known to him. Robert Maheu, former BU Agent previously stated he ordered coverage of Rowan on behalf of CIA's anti-Castro activities but did not order telephone tap. Investigation indicated Sam Giancana and John Roselli (both under investigation as top hoodlums in Chicago and Los Angeles, respectively) were possibly involved. Investigation being vigorously pressed to ascertain Maheu's, Giancana's and Roselli's full implication in this matter.

Classified by

6040

Exempt from GDS, Category C

Date of Declassification Indefinite

CONFIDENTIAL

FEDERAL BUREAU OF INVESTIGATION
U. S. DEPARTMENT OF JUSTICE
COMMUNICATIONS SECTION
JUL 8 1961

TELETYPE

Mr. Tolson	✓
Mr. Belmont	✓
Mr. Mohr	✓
Mr. Callahan	✓
Mr. Conrad	✓
Mr. DeLoach	✓
Mr. Evans	✓
Mr. Malone	✓
Mr. Rosen	✓
Mr. Sullivan	✓
Mr. Tavel	✓
Mr. Trotter	✓
Tele. Room	✓
Mr. Ingram	✓
Miss Gandy	✓

URGENT 7-7-61 10-28 PM KH
TO DIRECTOR, FBI 139-1201 AND SAC, LAS VEGAS 139-1
FROM SAC, LOS ANGELES 139-77 1 P

ARTHUR JAMES BALLETTI, ET AL. A UPUC. RE LAS VEGAS RAD JULY SIX
LAST. JOHN ROSELLI CONTACTED TODAY IN BEVERLY HILLS, CALIF.

ADMITTED HE HAS KNOWN ROBERT MAHEU FOR ABOUT FIVE YEARS, BUT
DECLINED TO ANSWER ANY OTHER QUESTIONS. REC-91 139-1201-67

LV TO BE ADVISED

HOLD PLS

JUL 13 1961

JUL 13 1961

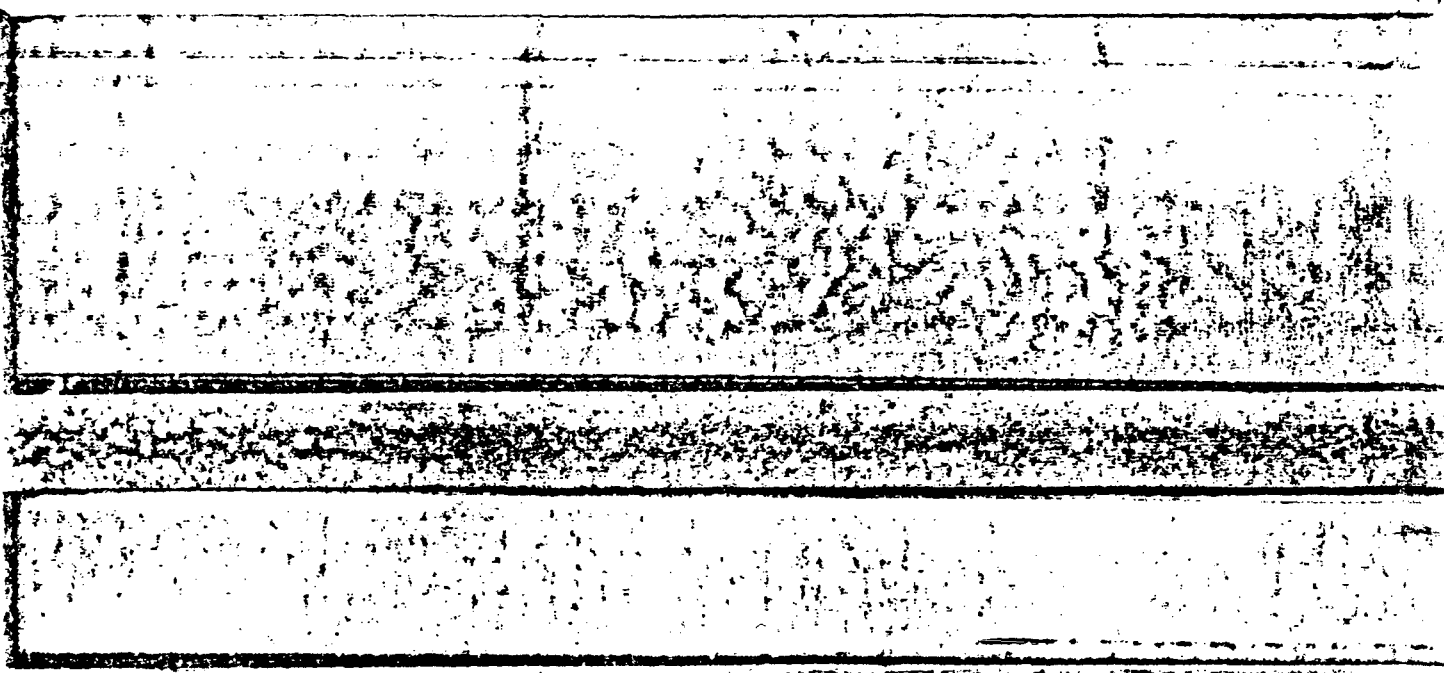

FBI

Date: 7/14/61

Transmit the following in _____
(Type in plain text or code)

Via AIRTEL AIR MAIL
(Priority or Method of Mailing)

TO: DIRECTOR, FBI (139-1192)
FROM: SAC, LOS ANGELES (139-77)
RE: ARTHUR JAMES BALLETTI; ET AL
UPUC
OO: Las Vegas

Re Buairtel 7/10/61 and 7/11/61.

MAHEU reinterviewed in Beverly Hills, California on 7/13/61.

MAHEU stated that in October, 1960, he requested EDWARD L. DUBOIS, JR., Miami Beach, Florida to institute technical surveillance on DAN ROWAN at the Riviera Hotel in Las Vegas, Nevada, but left details to DUBOIS. He claims he does not recall if he specified type of installation to be used but was interested only in conversation within ROWAN's room and had in mind the installation of a microphone and transmitter and not a telephone tap. He claims he definitely did not request a physical surveillance.

MAHEU stated he takes full responsibility for ordering this installation and that although he discussed installation with JOHN ROSELLI it was not made at ROSELLI's request or at the request of SAMUEL GIANCANA or for GIANCANA's benefit. He stated that this was his own decision based on reasons given in a previous interview.

MAHEU insists he does not know unknown subject, aka J. W. Harrison and denies he made a call to DUBOIS to substitute one of his own men as claimed by DUBOIS. Stated DUBOIS charged him for transportation and time for two men.

- 3 - Bureau
- 1 - Las Vegas (139-1)(AM)
- 2 - Miami (139-63)(AM)
- 1 - Chicago (139-105)(AM)
- 2 - Los Angeles

EX-116 REG-21 101-68

JUL 17 1961
FBI
LOS ANGELES

WYW:djv

Approved: _____
Special Agent in Charge

Sent _____ M Per _____

LA 139-77

ROSELLI in Las Vegas, Nevada but MAHEU expects him to be in Los Angeles the first of next week.

Miami will reinterview BALLETTI and DUBOIS in an effort to identify unknown subject.

Los Angeles will attempt to reinterview ROSELLI on 7/17/61 if he is at his Los Angeles apartment.

Report being submitted.

FEDERAL BUREAU OF INVESTIGATION

Reporting Office LOS ANGELES	Office of Origin LAS VEGAS	Date 7/20/61	Investigative Period 7/6-19/61
TITLE OF CASE ARTHUR JAMES BALLETTI; UNSUB, aka J. W. Harrison		Report made by [REDACTED]	Typed By: ALH
		CHARACTER OF CASE UPUC	

b7c

REFERENCES:

Report of SA **[REDACTED]** dated 6/30/61 at Los Angeles. *u*

Bureau airtel to Los Angeles dated 7/10/61. *u*

Bureau airtel to Las Vegas, Los Angeles, Miami, Washington Field Office, and Chicago dated 7/11/61. *u*

Los Angeles airtel to the Bureau dated 7/14/61. *u*

- RUC -

ALL INFORMATION CONTAINED
HEREIN IS UNCLASSIFIED *70-2141-22,330*
DATE *3/9/81* BY *SP4 Jmk/kaa*

CM

Approved <i>[Signature]</i>	Special Agent in Charge	Do not write in spaces below	
Copies made:		139-1201-169	REC-92
<ul style="list-style-type: none"> ② - Bureau (139-1201) 3 - Las Vegas (139-1) (1 - USA, Reno) 1 - Miami (139-63) (info) 1 - Chicago (139-105) (info) 3 - Los Angeles (139-77) (1 - 92-113) 		EX 113	11 32 AM '61
		10 JUL 25 1961	REC'D - CIA MICHLE

cc: AAG Criminal Division
Form 6-94 (10) *7-21-61 [Signature]*

COVER PAGE

~~cc: AAG Criminal Division
Form 6-94~~

[Handwritten signature]

53 AUG 1 1961

UNITED STATES DEPARTMENT OF JUSTICE
FEDERAL BUREAU OF INVESTIGATION

Copy to: 1 - USA, Reno

~~TOP SECRET~~

Report of: *b7c* [redacted] ALH
Date: July 20, 1961

Office: Los Angeles, California

Field Office File No.: 139-77

Bureau File No.: 139-1201

Title: ARTHUR JAMES BALLETTI;
UNKNOWN SUBJECT, also
known as J. W. Harrison

Character: UNAUTHORIZED PUBLICATION AND
USE OF COMMUNICATIONS

~~CONFIDENTIAL~~
Classified by *6049*
Exempt from GDS by *2*
Date of Declass *10/17/76*
oclass

Synopsis:

ROBERT MAHEU stated he requested technical surveillance on DAN ROWAN by DUBOIS, but does not recall specific instructions. Was interested only in conversation in room and had in mind microphone, not telephone, tap. Claims decision to order installation was his own and not made at the request or for benefit of GIANCANA or ROSELLI. Denied knowing identity of unsub. ROSELLI admits knowing MAHEU but declined to answer other questions.

- RUC -

~~CONFIDENTIAL~~

DETAILS

DECLASSIFIED BY *SP4 Jm/K*
ON *3/1/81* *FOIA 422,330*

*TIA info declassified per
John E. Bacon 8/27/80

APPROPRIATE AGENCIES
AND FIELD OFFICES
ADVISED BY ROUTING
SLIP(S) OF *Declassified*
DATE *3-25-81*

~~TOP SECRET~~
10/17/76
139-1201-43

Date 7/17/61

ROBERT MAHEU was interviewed at 190 North Canon Drive, Beverly Hills, California, on July 13, 1961. MAHEU was informed of his right to an attorney and that he did not have to answer questions and that anything he did say could be used against him in a court of law. MAHEU stated that in connection with the confidential assignment for Central Intelligence Agency (CIA) he had been in contact with SAMUEL GIANCANA and had received valuable assistance from GIANCANA, which, in turn, was furnished to CIA. MAHEU had reason to believe that GIANCANA may have disclosed information regarding the project and, in view of the sensitive nature of the project, he, MAHEU, decided to determine whether or not GIANCANA had actually talked to unauthorized persons. He was aware that GIANCANA was very close in a romantic way with PHYLLIS MC GUIRE of the Mc Guire Sisters Trio. He said that if GIANCANA had disclosed this information regarding project to anyone, he would have disclosed it to PHYLLIS MC GUIRE. He said that he was also aware that in the fall of 1960 the relations between PHYLLIS MC GUIRE and GIANCANA were strained and that PHYLLIS was romantically involved with DAN ROWAN, who was appearing at the Riviera Hotel in Las Vegas. He considered it very vital to determine whether or not GIANCANA was reliable and decided to order an installation on DAN ROWAN's room in an effort to determine whether or not GIANCANA had disclosed any information regarding the project to PHYLLIS MC GUIRE. (u)

MAHEU stated that this decision was his own and that GIANCANA had no knowledge that the installation was made. He said that he did discuss this with JOHN ROSELLI, since he felt obligated to discuss it with ROSELLI, as ROSELLI had been instrumental in putting him in contact with GIANCANA. MAHEU denied that the installation was made at the request of ROSELLI or GIANCANA or for the benefit of either ROSELLI or GIANCANA.

- 2 -

On 7/13/61 at Beverly Hills, California File # Los Angeles 139-77
 by SA [REDACTED] and [REDACTED] ALH Date dictated 7/17/61

LA 139-77

He said that he did discuss his decision with ROSELLI some time prior to ordering the installation but does not recall the specific date or place where he discussed the matter with ROSELLI. He pointed out that he does not recall whether or not this occurred during October, 1960, when they were both registered at the Kenilworth Hotel in Miami Beach, Florida. He pointed out that he had met with ROSELLI on a number of occasions and, therefore, does not recall the specific occasion in which he discussed his decision with ROSELLI. He does not recall what comment ROSELLI made when informed of his decision. U

MAHEU said that he requested EDWARD J. DUBOIS, Jr., a Miami Beach private investigator, to institute a technical surveillance of DAN ROWAN's room at the Riviera Hotel in Las Vegas, Nevada. He said that he does not recall what his specific requests were regarding the type of installation to be used, but had left this up to DUBOIS. He said that he was interested only in conversation within DAN ROWAN's room and had in mind the installation of a microphone and transmitter and not a telephone tap. He said, however, that he does not recall whether or not he specified not to make a telephone installation. He said that he does recall that he definitely did not request a physical surveillance of ROWAN. U

FLA

MAHEU stated that he does not know the identity of the unknown subject, also known as J. W. Harrison. He said that he definitely did not contact DUBOIS and tell DUBOIS that he would send one of his men. He insisted that DUBOIS had furnished both men to handle this assignment in Las Vegas and that DUBOIS had charged him for transportation and time for two men. U

LA 139-77

MAIEU repeated that he would take full responsibility for ordering the installation, that the installation was made for the reasons he had given above and in a previous interview, and definitely was not made at the request or for the benefit of JOHN ROSELLI or SAMUEL GIANCANA.

4

Date 7/13/61

JOHN ROSELLI was contacted at Drucker's Hair-dressers for Men, 5700 Wilshire Boulevard, Beverly Hills, California. ROSELLI was informed of his right to have an attorney and that he did not have to say anything and that anything he did say could be used against him in a court of law. u

ROSELLI admitted that he has known ROBERT MAHEU for approximately five years. When asked if he knew SAM GIANCANA, ROSELLI stated, "Let's discuss the weather. I do not care to answer any more questions." ROSELLI stated that he knew of nothing illegal that MAHEU had done, but for any additional information regarding his association with MAHEU, the Agents should talk with MAHEU himself. u

- 5 -

On 7/7/61 at Beverly Hills, California File # Los Angeles 139-77

by SA [REDACTED] and SAA [REDACTED] : ALH Date dictated 7/10/61

LA 139-77

~~CONFIDENTIAL~~

b7c [REDACTED] ROSELLI was telephonically contacted by SA [REDACTED] at his Los Angeles apartment, 1251 Crescent Heights Boulevard, Los Angeles, on July 19, 1961, in an effort to arrange an interview. ROSELLI advised that he did not care to discuss his association with MAHEU at any time with the FBI. u

CALIF.

FLA.

~~CONFIDENTIAL~~

FEDERAL BUREAU OF INVESTIGATION

Reporting Office CHICAGO	Office of Origin LAS VEGAS	Date 7/19/61	Investigative Period 7/11 - 18/61
TITLE OF CASE ARTHUR JAMES BALLETTI; UNKNOWN SUBJECT, aka J. W. Harrison		Report made by [REDACTED]	Typed By: kzh
		CHARACTER OF CASE UPUC	

7-27-61

REFERENCES: Report of SA **[REDACTED]** dated **6/28/61**, at Chicago.
 Report of SA **[REDACTED]** dated **6/30/61**, at Los Angeles.

- RUC -

ADMINISTRATIVE

Information copies of this report are being furnished to those Offices designated in view of their investigation.

*CIV RIGHTS
FBI*

Approved <i>[Signature]</i>	Special Agent In Charge	Do not write in spaces below	
Copies made: 2 - Bureau (139-1201) 3 - Las Vegas (139-1) (1 - USA, Reno) 1 - Los Angeles (139-77) (INFO) 1 - Miami (139-63) (INFO) 1 - Washington Field (139-61) (INFO) 1 - Chicago (139-105)		139-1201	REC-18
		U.S. DEPT. OF JUSTICE BUL 24 1961	

1cc: AAG Civil Rights Division
Form 6-94 *7/19/61*

COVER PAGE

FBI
REC.D - CIV RIGHTS

UNITED STATES DEPARTMENT OF JUSTICE
FEDERAL BUREAU OF INVESTIGATION

Copy to: 1 - USA, Reno *b7c*

Report of: SA [REDACTED] Office: Chicago
Date: 7/19/61

Field Office File No.: 139-105 Bureau File No.: 139-1201

Title: ARTHUR JAMES BALLETTI;
UNKNOWN SUBJECT, aka
J. W. Harrison

Character: UNAUTHORIZED PUBLICATION OR USE
OF COMMUNICATIONS

Synopsis:

SAMUEL M. GIANCANA interviewed at O'Hare International Airport, Chicago, 7/12/61, by Bureau Agents and refused to make any comment regarding ROBERT MAHEU and refused to admit that he was acquainted with DAN ROWAN stating that he had no comment.

- RUC -

DETAILS:

Date July 18, 1961

SAMUEL M. GIANCANA was interviewed at the O'Hare International Airport, commencing at 7:10 p.m. as he departed from American Airlines Flight 66, arriving from Phoenix, Arizona. **GIANCANA** was a passenger on this flight under the name of **MOONEY CECOLA**.

GIANCANA was approached by the Bureau Agents as he departed from the Airline. He brushed off the attempts of the Agents to identify themselves and stated that he was well aware of the fact that the Agents were representatives of the FBI. He stated that he had absolutely nothing to say to the Agents. From the very outset and throughout the interview, **GIANCANA** was alternately obscene, abusive, and sarcastic. At no time did he exhibit a friendly or cooperative attitude.

He asked relative to the reason for the interview and at this point was questioned concerning his knowledge of the wire tapping of the hotel room of **DAN ROWAN** in Las Vegas. **GIANCANA** replied that he had absolutely no comment and had absolutely nothing to say. He refused to admit that he is acquainted with the identity of **ROWAN** and repeatedly refused any comment concerning that situation. When asked whether he was acquainted with **ROBERT MAHEU**, **GIANCANA** very belligerently refused to make any comment or to indicate in any manner that he was aware of the identity of **MAHEU**.

GIANCANA became very abusive and obscene and very heatedly advised that he was well aware of the FBI's investigations of him. He stated that he is aware of the identity of SA [REDACTED] and aware of the fact that SA [REDACTED] has talked to numerous girlfriends, relatives, and other associates of his.

At this point, **GIANCANA** requested the Agents to move away from him and leave him alone. It was pointed out to him that he was in the public waiting room of American Airlines and that the Agents had every right to be situated where they were. It was pointed out to **GIANCANA** that he was not under arrest and that the FBI had no interest in detaining him. It was made clear to him that he had every opportunity to leave his present location and that the FBI had absolutely

On 7/12/61 at O'Hare Airport
Chicago, Illinois File # CG 139-105
CG 92-349
by SAs [REDACTED] and [REDACTED] Date dictated 7/13/61
jmb

This document contains neither recommendations nor conclusions of the FBI. It is the property of the FBI and is loaned to your agency; it and its contents are not to be distributed outside your agency.

CG 139-105
CG 92-349

no objections to his reboarding his airplane en route to New York. It was pointed out to him that as far as the Agents were concerned there was absolutely no reason for his presence in Chicago and there was no objection to his leaving without plans to return.

At this point in the conversation, GIANCANA created a disturbance by accusing passengers who had disembarked from American Airlines Flight 66 of being FBI Agents.

b7C SA [REDACTED] and when told, advised he was well aware of SA [REDACTED] identity. When it was pointed out to him that this seemed to be unusual since SA [REDACTED] has been in no way concerned with any investigation of GIANCANA, GIANCANA replied that he was aware of this and was also aware of the individuals whom SA [REDACTED] has been investigating. He also b7C b7C advised that he is aware of the fact that SA [REDACTED] is a "member of the Bar."

At this point, GIANCANA became very curious concerning PHYLISS MC GUIRE. He attempted to locate her but was unable to do so. He thereupon became very abusive and obscene, commenting that it is a sad situation when the government interferes with the normal relationship between a man and his girlfriend. He accused the Agents of taking Miss MC GUIRE away from him without her consent. He was advised that Miss MC GUIRE made absolutely no objection to leaving him and conversing with other Agents.

At this point, GIANCANA asked the Agents if they had ascertained how many men he had killed. GIANCANA was asked if he could furnish the Agents information in that regard and said that he could not remember; however, he thought he might have to be responsible for a killing shortly, looking at the Agents while making the remark. He was asked if that remark was a threat to the Agents and denied making any threats and said that it was not a threat.

b7C GIANCANA referred again to investigations being conducted regarding his activities and made a remark "my sister-in-law told me all about you [REDACTED] and about the threats

CG 139-105
CG 92-349

which you made if she refused to furnish information. She also told me that you told her that I had killed 13 men." The Agent emphatically denied the above remark by GIANCANA and asked him if he was referring to an interview conducted of Mrs. ROSE FLOOD, a sister-in-law of GIANCANA. GIANCANA shrugged his shoulders and merely replied "don't worry, I have it all down in writing."

At that point, GIANCANA then represented his ticket, and announced in a loud voice in the presence of everyone in the waiting room of American Airlines that he was "going to get the hell out of here and go to Cuba." GIANCANA thereupon reboarded American Airlines Flight 66 en route to New York City.

After approximately five minutes, when it apparently became obvious to GIANCANA that Miss MC GUIRE was not aboard the airline and, apparently did not intend to board, GIANCANA again disembarked from the airline. He approached the Agents, again in the waiting room of American Airlines and in a loud voice again became very abusive and obscene concerning his inconveniences and the fact that Miss MC GUIRE had separated herself from him. He stated that the United States Government had lost all its fineness and that "American citizens might as well be in Russia" due to the treatment which he was receiving. It was again pointed out to GIANCANA that the Agents had no desire that he remain in Chicago and would be very happy if he remained on Flight 66 en route to New York City. It was again pointed out to him that he was not under arrest and the FBI had no interest in detaining him and he was free to come and go as he pleased.

GIANCANA again remarked "This country is getting just like Russia where a man is not free to escort a young lady where he pleases. Why don't you investigate these dope fiends." He was asked if that remark implied that he had information relating to narcotics and his reply to that question was "Why aren't you investigating the Communists." GIANCANA was asked if he was dissatisfied with this country and replied I love this country and I would sacrifice my life for it. He said "I proved this not long ago." He was asked to clarify the last remark and he refused to comment.

CG 139-105

CG 92-349

GIANCANA then sarcastically asked the Agents if they had found out that he owned 25 per cent of Marshall Fields, 20 per cent of Carsons, and 20 per cent of Goldblatts Department store to which the Agents asked if this were a statement on his part and he replied "Yes, I own all of these places" again in a sarcastic manner. He was asked if he had any interest in Las Vegas, Nevada, and he stated that "I own 99 per cent of Las Vegas." GIANCANA then sneeringly asked what the Agents desired to know and invited a question about his activities. The question then put to him was if he would confirm the allegations that he was the head of organized criminal activity in Chicago. He replied I'm not the head of anything and I don't know what you are talking about. After making this remark, GIANCANA uttered a few more obscenities.

GIANCANA then stated "If you want to talk to me give me a subpoena and I will appear before the Grand Jury and answer any and every question put to me." He was asked if he meant by this that he would answer every question truthfully or if this meant that he would stand on his Constitutional guarantee of the 5th Amendment. He replied "that all depends on the question."

GIANCANA advised the Agents that he was aware of the fact that the FBI would make every attempt to "frame" him into the penitentiary, at which point the Agents advised GIANCANA the FBI conducts its investigations on an impersonal, unbiased manner and that the history of this organization is not that of "framing" anyone and this is certainly not the intention or the purpose of this investigation. GIANCANA then referred to his prison sentences, stating "If I go to the penitentiary this time, I'll go like a man just like I did the other time and you know what I'm talking about." The Agents stated that they did not know what he was talking about and he replied "I went like a man then even though I was a victim of circumstances." He was asked how he was a victim of circumstances in the instances where he had been given jail terms and he refused to comment further about how he was victimized.

CG 139-105
CG 92-349

GIANCANA was asked if he was acquainted with JOHN D'ARCO, an Alderman of the First Ward of Chicago. At this point, GIANCANA said whose D'ARCO. It was pointed out to GIANCANA that Mr. D'ARCO had commented at one time recently that he was acquainted with Mr. GIANCANA and knew him well. At that point, GIANCANA directed an obscene remark to Mr. D'ARCO and requested the Agents to pass on the obscenity to Mr. D'ARCO. He was asked if he knew MURRAY HUMPHREYS and he stated he did not know MURRAY HUMPHREYS. He was asked if he knew GUS ALEX and he replied "No, I don't know GUS ALEX. Do you think I know everyone in the world."

GIANCANA then indicated that he was aware that the Agents intended to report the results of this interview of him to their "boss", who in turn would report the results to their "super boss", who would thereupon report to his "super super boss". He was asked to whom he was referring to as "boss", "super boss", and "super super boss" and he said "you know who I mean, I mean the KENNEDYS." He then said "I know all about the KENNEDYS and PHYLISS (MC GUIRE) knows a lot more about the KENNEDYS and one of these days we are going to tell all." When asked for clarification of his comments in this regard, GIANCANA uttered an obscenity and refused further comment.

GIANCANA then made a reference to ADALI STEVENSON and vaguely criticized his conduct in office and the manner in which he has involved the United States in the Cuban situation. When asked for clarification in this regard, GIANCANA stated that he has knowledge that STEVENSON directed "that mess in Cuba" and stated that STEVENSON is a "book worm" who has no common sense.

GIANCANA then advised that the United States Government is not as smart as it would like to think it is. He stated that he knows that the United States Government made a deal with FIDEL CASTRO during the BATISTA Regime to furnish support to CASTRO and assist him in his ascent to power in Cuba on the condition that when CASTRO came into power he would eliminate gambling in Cuba. GIANCANA stated "now that deal has boomeranged on you, hasn't it." When it was mentioned to GIANCANA that at least one good affect of the

CG 139-105
CG 92-349

b7c
above situation might have taken place in that his interest in Cuba were destroyed, GIANCANA then became very emotional and abusive and commented that he had never been in Cuba and had no interest in Cuba. When asked whether the individuals who ran gambling in Cuba during the BATISTA Regime were subordinates, GIANCANA refused to comment. He also refused to identify [REDACTED] as an associate of his.

At this point, GIANCANA advised that it is his firm belief that he is being "persecuted" due to the fact that he is a member of the Italian nationality. When it was pointed out to him that the investigations by the FBI of MURRAY HUMPHREYS and GUS ALEX have been pursued just as vigorously as the investigation of him and that HUMPHREYS and ALEX are not Italians, GIANCANA then uttered a string of obscenities and indicated that by far the majority of the individuals investigated by the United States Government were of Italian descent. He pointed out that it was his opinion that the FBI "not only prosecutes but persecutes Italians." When asked for specifics concerning what he intended to indicate by this comment, GIANCANA again referred to the fact that he was not being allowed to associate with his girlfriends in a normal fashion. It was pointed out to GIANCANA again that Miss MC GUIRE accompanied other Agents for a purpose of interview entirely under her own volition.

On more than one occasion during the interview, GIANCANA advised that he did not intend to "take this thing sitting down." He very heatedly stated: "I'm going to light a fire under you guys and don't forget that." When asked for clarification of his comments, GIANCANA refused any further comment. When asked how he enjoyed his recent visit to Florida, GIANCANA very sarcastically said "yew, I have been in Florida and I own the Fountainbleau, The Americana, and The Diplomat." When asked whether it was true that he owned the Eden Roc, GIANCANA sarcastically affirmed the Eden Roc also.

CG 139-105
CG 92-349

When requested whether he would desire that the Agents telephonically contact one BUTCH BLASI in order to provide him transportation from the airport, GIANCANA replied "yes, call Butch and tell him to bring two shotguns with him." When asked whether he intended that remark as a threat to the Agents, GIANCANA replied that he did not.

GIANCANA facetiously referred to the fact that in Russia if you commit a crime they merely shoot you rather than send you to prison. His next comment was that "I think I will kill myself. Why don't you give me a pistol so I can do this?" GIANCANA made remarks throughout the interview to the effect that he was going to kill himself. Regarding his general health, GIANCANA remarked that he "had a cancer"; however, he did not elaborate on this and stated "if you want to find out any more about my health, see my doctor." When asked as to the identity of the doctor, he refused to disclose his identity.

On frequent intervals during the conversation with GIANCANA, it was pointed out to him that he was not under arrest and that the FBI had no intention of detaining him. It was pointed out to him that the FBI did not desire to harass him or any of his associates and that he was entirely free to leave the area at his desire. It was also pointed out to him that he was under absolutely no obligation to converse with the Agents and that his Constitutional privileges were fully guaranteed.

GIANCANA frequently during the conversation proclaimed in a loud voice scattered with obscenities "get away from me you (obscene) and quit bothering me. I don't want to talk to you." At each such instance, it was pointed out to GIANCANA that he was free to leave at any time, that he was in a public place and that he was not by any means being detained.

CG 139-105
CG 92-349

The conversation was terminated upon the appearance of Miss PHYLISS MC GUIRE whom GIANCANA had previously referred to during the conversation as "the Mrs." He was asked if he was married to Miss MC GUIRE and he said sarcastically "I married her a long time ago." Upon Miss MC GUIRE's appearance, GIANCANA stated to her in a loud and clear voice "Why didn't you tell them to go to hell like I did." GIANCANA, accompanied by Miss MC GUIRE, then left the interviewing Agents.

7/27/61

airtel

To: SACs, Las Vegas (139-1)
Los Angeles (139-77)
Miami (139-63)
Washington Field (139-61)

From: Director, FBI (139-1202)

ARTHUR JAMES BALLETTI, et al.
UPUC

REC-18

ReBuairtel 7/11/61.

Expedite completion and submission of reports
and by return mail advise date reports being submitted.

WLM:jam
(10)

MAILED 2
JUL 27 1961
COMM-FBI

- Tolson _____
- Belmont _____
- Mohr _____
- Callahan _____
- Conrad _____
- DeLoach _____
- Evans _____
- Malone _____
- Rosen _____
- Sullivan _____
- Tavel _____
- Trotter _____
- Tele. Room _____
- Ingram _____
- Gandy _____

66 AUG 11 1961

MAIL ROOM TELETYPE UNIT

INFORMATION CONTAINED HEREIN IS UNCLASSIFIED
 DATE 08-14-2001 BY 60322 UCBAW/SJS
 DATE 08-14-2001 BY 60322 UCBAW/SJS

RECEIVED
 JUL 27 1961

COMM-FBI

FBI

Date: 8/1/61

Transmit the following in _____
(Type in plain text or code)

Via AIRTEL AIR MAIL
(Priority or Method of Mailing)

FO. 117 37 1 11
8-11 23

TO: DIRECTOR, FBI (139-1202)

FROM: SAC, LOS ANGELES (139-77)

RE: ARTHUR JAMES BALLETTI; ET AL
UPUC

ReBuairtel 7/27/61. *b7c*

RUC report of SA [REDACTED] submitted 7/20/61.

RUC

- 3 - Bureau
- 1 - Los Angeles
- HFD/sgt
- (4)

REC-23 / 39-1201-71

AUG 3 1961

EX-107

U.S. DEPT. OF JUSTICE
F. B. I.
AUG 3 1961

AUG 8 1961

Approved: [Signature] Sent _____ M Per _____
Special Agent in Charge

FBI

Date: 8/1/61

Transmit the following in _____
(Type in plain text or code)

Via AIRTEL AIRMAIL
(Priority or Method of Mailing)

TO: DIRECTOR, FBI (139-1202)

FROM: SAC, MIAMI (139-63)

ARTHUR JAMES BALLETTI;
ET AL
UPUC

RUC report being submitted this date.

RUC P

- 3 - Bureau (AM)
- 1 - Las Vegas (info)
- 1 - Miami
- RMM/neb
- (5)

REC-21 139-1201-72

17 AUG 3 1961

[Handwritten signature]

U.S. DEPT. OF JUSTICE

AUG 3 11 00 AM '61

AUG 3 11 22 AM '61

Approved: WGC/WB
Special Agent in Charge

Sent _____ M Per _____

58 AUG 8 1961

REC'D - CIA WICKLE

Airtel

8-3-61

100-217 To LV
8-8-61

To: SAC, Las Vegas (139-1)
From: Director, FBI (139-1202)
ARTHUR JAMES BALLETTI;
ET AL
UPUC

PERSONAL ATTENTION

Rereps from LA 7-20-61 and MM 8-1-61.
By return airtel advise what further investigation
pending and when report will be received at Bureau. This mat
must be afforded immediate and continuous attention.

LEC:vhm
(4)

NOTE: All leads known to Bureau have now been covered and
reported.

ALL INFORMATION CONTAINED HEREIN IS UNCLASSIFIED
DATE 10-10-2013 BY 60322 JLR/STW

SEARCHED _____ INDEXED _____
SERIALIZED _____ FILED _____

MAILED 4
AUG - 3 1961
COMM-FBI

- Tolson _____
- Belmont _____
- Mohr _____
- Callahan _____
- Conrad _____
- DeLoach _____
- Evans _____
- Malone _____
- Rosen _____
- Sullivan _____
- Tavel _____
- Trotter _____
- Tele. Room _____
- Ingram _____
- Gandy _____

REC-92

JK
LCL
139-1201-7

62 AUG 9 1961

TELETYPE UNIT

1113

FEDERAL BUREAU OF INVESTIGATION

Reporting Office MIAMI	Office of Origin LAS VEGAS	Date 8/1/61	Investigative Period 7/31-8/1/61
TITLE OF CASE ARTHUR JAMES BALLETTI; UNSUB, aka J. W. Harrison		Report made by [REDACTED]	Type of Report b7c :ush
		CHARACTER OF CASE UPUC	

NEW YORK

REFERENCES: Los Angeles airtel to Director, dated 7/14/61.
 Report of SA [REDACTED] dated **b7c** 7/19/61, at Las Vegas.
 Bureau airtel to Las Vegas, dated 7/27/61.

- RUC -

ADMINISTRATIVE

Copies of this report are being sent to Chicago and Los Angeles for information purpose because these offices may be requested to conduct additional investigation.

Approved <i>Wofwsh</i>	Special Agent In Charge	Do not write in spaces below	
Copies made: (2) - Bureau (139-1201) 3 - Las Vegas (139-1) (1 - USA, Reno) 1 - Chicago (Info) (139-105) 1 - Los Angeles (Info) (139-77) 1 - Miami (139-63)		139-1201-74	REC-23
		17 AUG 3 1961	
		AUG 3 11 51 AM '61	

1cc: AAG Criminal Division
 Form 6-64 (6) *8-3-61 [Signature]*
 RECEIVED
 DIVISION OF INVESTIGATION

REC'D - [Signature]
 [Signature]

Property of FBI - This report is loaned to you by the FBI, and neither it nor its contents are to be distributed outside the agency to which loaned.

66 AUG 9 1961

UNITED STATES DEPARTMENT OF JUSTICE
FEDERAL BUREAU OF INVESTIGATION

Copy to: 1 - USA, Reno

Report of:

Date:

[REDACTED] b7c
August 1, 1961

Office: Miami, Florida

Field Office File No.:

139-63

Bureau File No.:

139-1201

Title:

ARTHUR JAMES BALLETTI;
UNKNOWN SUBJECT, also
known as J. W. Harrison

Character:

UNAUTHORIZED PUBLICATION AND
USE OF COMMUNICATIONS

Synopsis:

ARTHUR JAMES BALLETTI and EDWARD L. DuBOIS, JR.
reinterviewed and state they can furnish no
additional information re identity Unknown
Subject.

- RUC -

Date 8/1/61

On July 31, 1961, EDWARD DuBOIS was interviewed at his office in the Ainsley Building, Miami.

At the outset of the interview, Mr. DuBOIS was advised that he did not have to make a statement and that if he did make a statement, it could be used against him in a court of law. He was advised of his right to an attorney.

Mr. DuBOIS said that he has no additional information to furnish re the identity of J. W. HARRISON. Mr. DuBOIS added that he furnished all information he had in this case to the FBI in previous interviews.

On 7/31/61 at Miami, Florida File # MI 139-63
by Special Agent [REDACTED] :ush Date dictated 8/1/61

Date 8/1/61

On August 1, 1961, ARTHUR JAMES BALLETTI was interviewed at his office in the Ainsley Building, Miami.

At the outset of the interview Mr. BALLETTI was advised he did not have to make a statement and that if he did make a statement it could be used against him in a court of law. He was advised of his right to an attorney.

Mr. BALLETTI stated that he only knows the operator who was with him at Las Vegas as J. W. HARRISON. BALLETTI stated he has no additional information concerning HARRISON's identity and that if he does get additional information, he will furnish it to the FBI.

On 8/1/61 at Miami, Florida 67C File # MM 139-63
by Special Agent [REDACTED] ush Date dictated 8/1/61

- 3* -

FBI

Date: 8/3/61

Transmit the following in PLAINTEXT
(Type in plain text or code)

Via AIRTEL AIR MAIL
(Priority or Method of Mailing)

Copy

TO : DIRECTOR, FBI (139-1202)

JFW FROM : SAC, LAS VEGAS (139-1)

~~CONFIDENTIAL~~

Classified by *10049*
Exempt from GDS Category *2*
Date of Declassification *11/17/77*
pdass

SUBJECT: ARTHUR JAMES BALLETTI, ET AL
UPUC
OO: LAS VEGAS

RE Bureau airtel dated 7/27/61.

All investigation in Las Vegas Division has been completed. This matter was discussed with USA HOWARD W. BABCOCK at Las Vegas on 8/2/61, relative to presentment to a FGJ. Mr. BABCOCK stated after reviewing all the investigative reports, that he is not certain in his mind, that it can be proven that any information received by BALLETTI, and UNKNOWN SUBJECT, Aka, J. W. HARRISON was ever disseminated, hence all necessary elements of violation would not be present.

Mr. BABCOCK stated that he is also concerned about possibility of information becoming known of ROBERT MAHEU performing work for CIA, and of his contact with SAMUEL M. GIANCANA. Mr. BABCOCK stated that it could conceivably cause embarrassment to the CIA and of course the US Government.

He stated that he still has the matter under consideration but feels somewhat reluctant to present the matter to FGJ since it appears doubtful that a True Bill would be

P.

REC-6 EX-105 139-1202-75

- 3-Bureau (A.M.)
- 1-Los Angeles (139-77) (Info.)
- 1-Miami (139-63) (Info.)
- 1-Washington Field (139-61) (Info.)
- 1-Chicago (139-105) (Info.)
- 2-Las Vegas

~~CONFIDENTIAL~~ AUG 8 1961

McDuff

MBP:crv
(9)

*Airtel to LV
8/9/61
EJM-ajl*

Approved: _____ Sent _____ M Per _____

Special Agent in Charge

DECLASSIFIED BY *SP4 JMB/SP4*
ON *3/9/81*
7/19/81
** CIA Info. Declassified per John E. Bacon 8/12/80*

LV 139-1

returned. u

Mr. BABCOCK said however, that he has not made a definite decision and would appreciate receiving the views of the Bureau and the Department, after consideration of the entire results of the investigation. u

The Bureau is requested to obtain views of the Department on this matter in order that same can be discussed with Mr. BABCOCK, and this matter be brought to a logical conclusion. u

8/10/61

AIRTEL

ALL INFORMATION CONTAINED
HEREIN IS UNCLASSIFIED *70280#22,330*
DATE 3/9/81 BY SP4 Jm/kaw

To: SAC, Las Vegas (139-1)
From: *EX-105 REC-6* Director, FBI (139-1202) - *75*

ARTHUR JAMES BALLETTI, et al.
UPUC

Reurairtel 8/3/61. *u*

The decision as to whether prosecutive action should be taken in these matters is within the province of the Department and therefore you should suggest to the U. S. Attorney that he may desire to discuss his views with the Criminal Division directly. *u*

If all logical investigation is completed, you should immediately submit a closing report for referral to the Department and conduct no further investigation UACB. *u*

NOTE:

MAILED 27
AUG 10 1961
COMM-FBI

After review of reports USA cannot make up his mind as to action to be taken relative to prosecution and would appreciate views of Bureau and Department. Since reports of all investigation have been furnished to U. S. Attorney and Department and decision as to prosecution is within province of Department, USA should discuss directly with Department. u

- Tolson _____
- Belmont _____
- Mohr _____
- Callahan _____
- Conrad _____
- DeLoach _____
- Evans _____
- Malone _____
- Rosen _____
- Sullivan _____
- Tavel _____
- Trotter _____
- Tele. Room _____
- Ingram _____
- Gandy _____

EJM:seo *u*
(4)

ecc/gmc
Christy
LES

F13
15/13
62 AUG 15 1961 TELETYPE UNIT

FBI

Date: 8/9/61

Mr. Belmont	
Mr. Mohr	
Mr. Casper	
Mr. Conrad	
Mr. DeLoach	
Mr. Evans	
Mr. Gale	
Mr. Rosen	
Mr. Sullivan	
Mr. Tavel	
Mr. Trotter	
Tele. Room	
Mr. Ingram	
Miss Gandy	

Transmit the following in PLAIN TEXT
(Type in plain text or code)

Via AIRTEL AIR MAIL
(Priority or Method of Mailing)

40
ggw

TO: DIRECTOR, FBI (139-1202)
 FROM: SAC, LAS VEGAS (139-1)
 SUBJECT: ARTHUR JAMES BALLETTI; aka,
 Et Al
 UPUC
 OO: LAS VEGAS

Copy
[Signature]

Re Las Vegas airtel dated 8/3/61 and Bureau airtel dated 8/3/61.

Current status regarding this matter set forth in re Las Vegas airtel. Further action being held in abeyance, pending reply from Bureau.

P. C. C. Wick
 (3) - Bureau
 1 - Las Vegas

MBP/mla
(4)

am

REC-61 139-1201-76

AUG 11 1961

7-102

[Signature]

66 AUG 17 1961

Approved: _____ Sent _____ M Per _____
Special Agent in Charge

FEDERAL BUREAU OF INVESTIGATION

Reporting Office LAS VEGAS	Office of Origin LAS VEGAS	Date 8/16/61	Investigative Period 8/2/61 - 8/16/61
TITLE OF CASE ARTHUR JAMES BALLETTI; UNKNOWN SUBJECT, Aka J. W. Harrison		Report made by [REDACTED] b7C CHARACTER OF CASE UPUC	Typed By: MBP:mjs

ALL INFORMATION CONTAINED
HEREIN IS UNCLASSIFIED *70 JPL #22,330*

11/4
c/

~~SECRET~~

REFERENCES: DATE *3/9/81* BY *SP4 Jim/Koa*

b7C

- Report of SA [REDACTED] dated 6/29/61 at Las Vegas;
- Report of SA [REDACTED] dated 6/30/61 at Los Angeles;
- Report of SA [REDACTED] JR. dated 7/19/61 at Chicago;
- Report of SA [REDACTED] dated 7/20/61 at Los Angeles;
- Report of SA [REDACTED] dated 8/1/61 at Miami;
- Las Vegas airtel to Bureau dated 8/3/61;
- Bureau airtel to Las Vegas dated 8/10/61.

COPIES DESTROYED

- C -

ADMINISTRATIVE DATA:

Upon return of USA HOWARD W. BABCOCK, who will be on vacation until about 9/1/61, it will be suggested to him that he might desire to discuss his views in this matter directly with the Criminal Division of the Department.

Approved <i>[Signature]</i>	Special Agent in Charge	Do not write in spaces below	
Copies made: ② - Bureau (139-1201) 1 - USA, Reno 1 - Chicago (139-105)(Info) 1 - Los Angeles (139-77)(Info) 1 - Miami (139-63)(Info) 1 - Washington Field (139-61)(Info) 1 - Las Vegas (139-1)		139-1201-77	REC-51
201 AAG Criminal Division Form 6-64 <i>E. J. [Signature]</i> <i>Sherrill Col Unit 5a</i>		20 AUG 18 1961	EX 1

[Handwritten signatures and initials]
LBI
REC-51

62 AUG 29 1961

This report is loaned to you by the FBI and neither it nor its contents are to be distributed outside the agency to which loaned.

LV 139-1

LEADS:

THE CHICAGO, LOS ANGELES, MIAMI, AND WASHINGTON FIELD DIVISIONS:
(INFORMATION:

An information copy of this report is being furnished
the Chicago, Los Angeles, Miami, and Washington Field Divisions.

- B* -

COVER PAGE

UNITED STATES DEPARTMENT OF JUSTICE
FEDERAL BUREAU OF INVESTIGATION

~~TOP SECRET~~

Copy to: 1 - USA, Reno

Report of: ~~REDACTED~~
Date: 8/16/61

Office: Las Vegas, Nevada

Field Office File No.: Las Vegas (139-1)

Bureau File No.: (139-1201)

Title: ARTHUR JAMES BALLETTI;
UNKNOWN SUBJECT, Aka,
J. W. Harrison

~~CONFIDENTIAL~~

Classified by 10040
Exempt from GDS
Date of Declassification 3/9/81
17/1177

Character: UNAUTHORIZED PUBLICATION AND USE OF COMMUNICATIONS

Synopsis: USA, Las Vegas, Nevada, advised not certain violation exists in this matter, and is reluctant to present matter to FGJ since it does not appear a true bill could be obtained, and in view of possible embarrassment to the U. S. Government in view of CIA action. *X(u)*

APPROPRIATE AGENCIES AND FIELD OFFICES ADVISED BY ROUTING SLIP(S) DATE 3-21-81

DECLASSIFIED BY SP4-Jm/Koz
ON 3/9/81 FOIA# 22,330

- C - *CIA Info Declassified per John E. Bacon 8/27/80

DETAILS:

AT LAS VEGAS, NEVADA:

On August 2, 1961, the facts in this matter were discussed with United States Attorney, HOWARD W. BABCOCK, relative to presentment to a Federal Grand Jury. He advised that he is not certain in his mind that it can be proven that any information received by BALLETTI and Unknown Subject, also known as J. W. HARRISON, was ever disseminated; hence, all necessary elements of violation would not be present.

Mr. BABCOCK also advised that he is very concerned about the possibility of information becoming known of ROBERT MAHEU performing work for the Central Intelligence Agency (CIA),

~~CONFIDENTIAL~~
~~TOP SECRET~~
Automatic

~~CONFIDENTIAL~~
and his contact with SAMUEL M. GIANCANA. Mr. BABCOCK stated that it could conceivably cause much embarrassment to CIA, and of course, to the U. S. Government. (u)

Mr. BABCOCK said he is reluctant to present the matter to a Federal Grand Jury since it appears doubtful that a true bill would be returned. He said he would appreciate receiving views of the Department of Justice in this matter. (u)

Assistant U. S. Attorney, RAYMOND E. SUTTON, advised on August 15, 1961, that Mr. BABCOCK is presently on vacation and would not return to duty until around September 1, 1961. (u)

~~CONFIDENTIAL~~

8-17-61

Airtel

To: SAC, Las Vegas ¹³⁹⁻¹²⁰¹ (139-1202)
From: Director, FBI ⁵⁰¹⁷⁶¹⁰ (139-1)

ARTHUR JAMES BALLETTI, aka, et al.
UPUC
OO:LV

Reurairtel 8-3-61 and Bureau airtel 8-10-61.

You should ascertain from USA whether he desired any further investigation in this case and if so and logical, advise the Bureau by airtel and conduct it on UACB basis allowing the Bureau sufficient time to review request.

Advise Bureau of results of contact with USA and if no additional investigation requested surep indicating so.

EJM:vhm
(4)

EX-11 REC-23

139-1201-7

AUG 18 1961

MAILED 3
AUG 17 1961
COMM-FBI

- Tolson _____
- Belmont _____
- Mohr _____
- Callahan _____
- Conrad _____
- DeLoach _____
- Evans _____
- Malone _____
- Rosen _____
- Sullivan _____
- Tavel _____
- Trotter _____
- Tele. Room _____
- Ingram _____
- Gandy _____

32 AUG 23 1961

MAIL ROOM TELETYPE UNIT

August 23, 1961

airtel

*11314 76 LV
8-28-61*

To: SAC, Las Vegas (139-1)

From: Director, FBI (139-1201)

**ARTHUR JAMES BALLETTI;
UNKNOWN SUBJECT, AKA;
UNAUTHORIZED PUBLICATION OR USE OF COMMUNICATIONS**

ReBuairtel 8-17-61.

Surep immediately. If report already submitted, advise date and name of reporting Agent.

EJM:rrb
(4)

- Tolson _____
- Belmont _____
- Mohr _____
- Callahan _____
- Conrad _____
- DeLoach _____
- Evans _____
- Malone _____
- Rosen _____
- Sullivan _____
- Tavel _____
- Trotter _____
- Tele. Room _____
- Ingram _____

MAILED 8
AUG 23 1961
COMM-FBI

REC-32

139-1201-79

EX-112

18 AUG 24 1961

90

MAIL ROOM TELETYPE UNIT

14 AUG 29 1961

FBI

Date: August 25, 1961

Transmit the following in PLAIN TEXT
(Type in plain text or code)

Via AIRTEL AIRMAIL
(Priority or Method of Mailing)

TO : DIRECTOR, FBI (139-1202) *Pat*

FROM : SAC, LAS VEGAS (139-1) *2-3) D*

SUBJECT: ARTHUR JAMES BALLETTI;
UNKNOWN SUBJECT, Aka;
UPUC

RE Bureau airtel to Las Vegas dated 8/23/61.

074 Closing report submitted by Las Vegas on 8/16/61 by SA 

C.

- ③ - Bureau (A.M.)
- 1 - Las Vegas

MBP:mds
(4)

REC-44

AUG 25 1961

Approved: _____

Special Agent in Charge

Sent _____

M

Per _____

August 30, 1961

airtel

To: SAC, Las Vegas (139-1)

From: Director, FBI (139-1202)

ARTHUR JAMES BALLETTI;
UNKNOWN SUBJECT, AKA;
UPUC

ReBuairtels 8-17,23-61, urep 8-16-61 and urairtel
8-25-61.

Rerep sets forth observations of USA as to prosecutive
merits of this case but does not indicate whether the USA
desires any further investigation in this matter.

In order to be certain that all avenues of logical
investigation have been completed and the USA desires no further
investigation, you should contact him in accordance with
instructions in Buairtel 8-17-61.

Advise Bureau within two days of receipt of this
airtel and if no further investigation desired by USA, surep
immediately after contact reflecting this.

EJM:rrb
(4)

MAILED 8
AUG 30 1961
COMM-FBI

68 SEP 6

MAIL ROOM TELETYPE UNIT

REC-13

139-1201-80X
19 AUG 31 1961

EX-112

[Handwritten signature]

FBI

915

Date: September 5, 1961

Transmit the following in PLAIN TEXT
(Type in plain text or code)

Via AIRTEL AIR MAIL
(Priority or Method of Mailing)

TO: DIRECTOR, FBI (139-1202)

Handwritten initials
FROM: SAC, LAS VEGAS (139-1)

RE: ARTHUR JAMES BALLETTI;
UNKNOWN SUBJECT, aka;
UPUC

Re Bureau airtel 8/30/61.

USA, HOWARD W. BABCOCK was contacted on 9/5/61, the first day of his return to Las Vegas, and he advised after careful review of this matter that he desires no further investigation conducted, inasmuch as it appears that all logical investigation has been completed.

Mr. BABCOCK stated that after careful review of the matter, he had decided not to present the matter to a Federal Grand Jury, inasmuch as he strongly feels no true bill could be obtained.

Mr. BABCOCK stated, however, that he was writing to the department of his decision in this matter.

In view of the above, no further investigation is being conducted and a closing report is being submitted.

P

3 - Bureau
1 - Las Vegas

NBP/nlw
(4)

EX-116

REC-84

139-1201-80X1

~~139-1201-5~~

9 SEP 7 1961

U.S. DEPT. OF JUSTICE
F. B. I.

SEP 11 11 51 AM '61

Handwritten signature
REC'D
LIAISON

Approved: _____ Sent _____ M Per _____
Special Agent in Charge

FEDERAL BUREAU OF INVESTIGATION

Reporting Office LAS VEGAS	Office of Origin LAS VEGAS	Date 9/7/61	Investigative Period 9/5/61
TITLE OF CASE ARTHUR JAMES BALLETTI; UNKNOWN SUBJECT, aka; J. W. Harrison		Report made by [REDACTED] <i>b7C</i>	Typed By: nlw
		CHARACTER OF CASE UPUC	

SYNOPSIS

REFERENCES:

b7C

Report of SA **[REDACTED]** at Las Vegas 8/16/61.
 Bureau airtel to Las Vegas 8/30/61.
 Las Vegas airtel to Bureau, 9/5/61.

- C -

ALL INFORMATION CONTAINED
 HEREIN IS UNCLASSIFIED *FOIPA # 22,330*
 DATE 3/9/81 BY SP4-jmk/ksa

dm

139-1201-80X2

Approved <i>[Signature]</i>	Special Agent in Charge	Do not write in spaces below	
Copies made: 2 - Bureau (139-1202) 1 - USA, Reno 1 - Las Vegas (139- <i>RECEIVED</i> <i>E.B.I.</i> Rec: AAG Criminal Division Form C-94 <i>1 during my...</i>		139-1201-80X2 20 SEP 1961 <i>[Handwritten notes]</i>	REC-65

RECEIVED

- A* -
COVER PAGE

REC'D - CIA

63 SEP 15 1961

UNITED STATES DEPARTMENT OF JUSTICE
FEDERAL BUREAU OF INVESTIGATION

~~TOP SECRET~~
~~CONFIDENTIAL~~

Copy to: 1 - USA, Reno

Report of: *b7c* [Redacted]
Date: 9/17/61

Office: Las Vegas, Nevada

Field Office File No.: 139-1

Bureau File No.: 139-1202

Title: ARTHUR JAMES BALLETTI; UNKNOWN SUBJECT,

DECLASSIFIED BY *SP4 Jm/Koa*
ON *3/9/81* *FOIPA # 22,330*

**CIA Info Declassified per John E. Bacon 8/27/80*
Character: UNAUTHORIZED PUBLICATION AND USE OF COMMUNICATIONS

Synopsis: USA, Las Vegas, advised he has decided not to present matter to Federal Grand Jury, since he does not believe indictment could be obtained.

Classified by *[Signature]*
Exempt from GDS, E.O. 11652
Date of Declassification Indefinite
10/17/80

DETAILS:

On September 5, 1961, Mr. HOWARD W. BABCOCK, District of Nevada, was contacted relative to this matter, and he advised he had decided not to present the facts in this matter to a Federal Grand Jury, inasmuch as he does not believe a true bill would be returned because no information, which would prove dissemination was ever developed.

Mr. BABCOCK again reiterated that he is very concerned about the possibility of information becoming known of ROBERT MAHEU performing work for the Central Intelligence Agency and his contact with SAMUEL M. GIANCANA. Mr. BABCOCK again stated that it could cause much embarrassment to the Central Intelligence Agency, and of course, to the United States Government.

Mr. BABCOCK stated he was writing a letter to the Department of Justice, setting forth the fact that he did not intend to present the matter to a Grand Jury and that in his opinion, all logical investigation had been completed and that he desires no further investigation.

~~CONFIDENTIAL~~

APPROPRIATE AGENCIES AND FIELD OFFICES ADVISED BY ROUTING SLIP(S) DATE 10/17/80

declassified
FOIPA # 22,330
10/17/80
43

~~CONFIDENTIAL~~

Office Memorandum • UNITED STATES GOVERNMENT

TO : Director, Federal Bureau of Investigation

DATE: October 9 1961

FROM : Herbert J. Miller, Jr., Assistant Attorney General
Criminal Division

HJM:BJA:cf

82-46-5

SUBJECT: Arthur James Balletti; Unknown Subject,
aka J. W. Harrison
Unauthorized Publication or Use of Communications

1-1
5-1
66

o/c

Reference is made to your memorandum of September 11, 1961, transmitting a copy of the report of Special Agent [redacted] dated September 7, 1961, at Las Vegas.

We are taking up this matter with the United States Attorney at Reno. We will advise you in the near future whether further investigation is desired.

32

OCT 10 1961

ALL INFORMATION CONTAINED
HEREIN IS UNCLASSIFIED 70372 #22,330
DATE 3/9/81 BY SP4 GJM/kaw

DOJ info unclassified per
E. Ross Buckley 3/2/81

EX-115

REC-52

159-1201-81

10 OCT 10 1961

OCT 10 15 1961

Antilpent LV
10-11-61
JWH/ML

REC-52
KIEHL2
[Signature]

10-11-61

airtel

To: SAC, Las Vegas (139-1) *substantive*
From: Director, FBI (139-1202) *REC 52 10/12/61 -81*

ARTHUR JAMES BALLETTI;
UNKNOWN SUBJECT, AKA;
UPUC

b7c

Re: SA [redacted] dated 9-7-61 at Las Vegas.

There is enclosed herewith for your information a copy of a memorandum dated 10-9-61 from the Criminal Division of the Department of Justice wherein it is stated that the Department is taking up this matter with the USA, Reno. *u*

Enclosure

JWH:rrb
(4) *JWH*

NOTE: The USA, LV, advised on 9-5-61 that he had decided not to present this case to the Federal grand jury as he did not believe an indictment could be obtained. This information was furnished to the Department. The Department now advises that they are to take up this matter with the USA, Reno, and will advise in the event further investigation is desired. *u*

ALL INFORMATION CONTAINED
HEREIN IS UNCLASSIFIED *FOIPA #22,330*
DATE 3/9/81 BY SP4-Jm/K

JWH

- Tolson _____
- Belmont _____
- Mohr _____
- Callahan _____
- Conrad _____
- DeLoach _____
- Evans _____
- Malone _____
- Rosen _____
- Sullivan _____
- Tavel _____
- Trotter _____
- Tele. Room _____
- Ingram _____
- Gandy _____

MAILED 19
OCT 11 1961
COMM-FBI

OCT 16 1961

MAIL ROOM TELETYPE UNIT

UNITED STATES GOVERNMENT

Memorandum

~~TOP SECRET~~

January 31 1962

TO : Director, Federal Bureau of Investigation

DATE:

FROM : *HJ* Herbert J. Miller, Jr., Assistant Attorney General
Criminal Division

HJM:BJA:cf

82-46-5

SUBJECT: Arthur James Balletti;
Unknown Subject, aka J. W. Harrison
Unauthorized Publication or Use of Communications

1-
5
2/T

Reference is made to your memorandum of May 22, 1961, regarding the interview of Colonel Sheffield Edwards, Director of Security, Central Intelligence Agency, regarding the captioned matter. (u)

It would be appreciated if you would reinterview Colonel Edwards to determine whether the Central Intelligence Agency would object to the institution of a criminal prosecution in which Robert Maheu might be a defendant. (u)

DECLASSIFIED BY *SPL-Jmm/KDA*
ON *3/9/81* To *IPa# 22,330*
**DOJ Info declassified per E. Ross Buckley 3/2/81*

*1 x [unclear]
[unclear]
[unclear]*

*More Rant to Plant
cc [unclear] 2/2/62
v [unclear]*

~~PROG.~~
FEB 1 1962

EX 100

100-1201-82

GROUP 1
Excluded from automatic
downgrading and
declassification

-C-5

5 FEB 2 1962
6

~~TOP SECRET~~

R [unclear]
[unclear]

278
51 FEB 9 1962

Memorandum to Mr. Belmont
Re: ARTHUR JAMES BALLETTI

ACTION

~~TOP SECRET~~

It is recommended that the Liaison Agent with CIA reinterview Colonel Edwards in accordance with the Department's request.

[Handwritten signatures and initials]
JFK
W
R
S
H
A
V
K

ADDENDUM 2-8-62 (SJK:ban):

On February 7, 1962, Colonel Edwards advised the Liaison Agent that his agency would object to any prosecution which would necessitate the use of CIA personnel or CIA information. He pointed out that an introduction of any evidence concerning the CIA operation would be most embarrassing to the U. S. Government.

~~TOP SECRET~~

UNITED STATES GOVERNMENT

Memorandum

TO : Mr. Belmont

DATE: February 2, 1962

FROM : A. Rosen

SUBJECT: ARTHUR JAMES BALLETTI, Et al.
UNAUTHORIZED PUBLICATION OR USE
OF COMMUNICATIONS

Mr. Tolson	
Mr. Mohr	
Mr. Callahan	
Mr. Conrad	
Mr. DeLoach	
Mr. Evans	
Mr. Gale	
Mr. Rosen	
Mr. Sullivan	
Mr. Tavel	
Mr. Trotter	
Tele. Room	
Mr. Ingram	
Gandy	

TOP SECRET

This case involves a wire tap placed on the telephone of Dan Rowan of the comedy team of Rowan and Martin by Arthur James Balletti and J. W. Harrison. Balletti was employed by Edward DuBois, a former Bureau Agent who runs a private investigating agency in Miami, Florida. Balletti admits to having been assigned to surveil Rowan in Las Vegas, Nevada, and was accompanied by J. W. Harrison, not further known to him who was supplied by Robert Maheu, another former Bureau Agent. Dan Rowan was reportedly engaged to Phyllis McGuire of the McGuire Sisters trio, who was also reportedly a girl friend of Sam Giancana. Giancana is under investigation by the Chicago Office as a top hoodlum.

Maheu claimed that he ordered coverage of Rowan in behalf of Central Intelligence Agency's (CIA) efforts to obtain intelligence information in Cuba through the hoodlum element, including Sam Giancana, which had interest there. Maheu said he was put in contact with Giancana in connection with these intelligence activities through John Roselli, a Los Angeles top hoodlum. Maheu authorized wiring of Rowan's room and discussed this matter with John Roselli.

Colonel John Sheffield Edwards, Director of Security, CIA, on 5/3/61 advised that Maheu was used as an intermediary with Sam Giancana, relative to CIA's anti-Castro activities. Colonel Edwards said that since this was "dirty business," CIA could not be knowledgeable of Maheu's techniques and therefore had no information as to whether a telephone tap was authorized.

CURRENT DEVELOPMENTS

The Department, by memorandum dated 1/31/62, has requested that we reinterview Colonel Edwards to determine whether the CIA would object to the institution of a criminal prosecution in which Robert Maheu might be a defendant.

- 1- Mr. Evans
- 1- Liaison Section

JWH:mc
(8)

Classified by 6049
Declassify on: OADR
EX-101
FEB 21 1962

EX 101

25 FEB 19 1962

FEB 21 1962

PERS. AFF. DIV.

DECLASSIFIED BY SP4 JMK/COE
 ON 3/9/81
 *CIA info declassified per OADR. E.O. 12958-2/2780
 Fee 55c 9/16/75

152

X(u)

C

TOP SECRET

REC 91/39-1201-8

~~TOP SECRET~~
Mr. Herbert J. Miller, Jr.
Assistant Attorney General

February 9, 1962

REC-91
Director, FBI 137-1201-83
EX 101

ARTHUR JAMES BALLETTI, et al.
UNAUTHORIZED PUBLICATION OR USE
OF COMMUNICATIONS

APPROPRIATE AGENCIES
AND FIELD OFFICES
ADVISED BY ROUTING
SLIP(S) OF DECLASSIFIED
DATE 3-25-81 ST

Reference is made to your memorandum of January 31, 1962.

SEARCHING DESK... 222 STOPS IN THESE CATEGORIES IN WHICH LOANED

Colonel Sheffield Edwards, Director of Security, Central Intelligence Agency (CIA), was contacted regarding this matter on February 7, 1962. Colonel Edwards advised that his agency would object to any prosecution which would necessitate the use of CIA personnel or CIA information. He pointed out that an introduction of any evidence concerning the CIA operation would be most embarrassing to the United States Government.

DECLASSIFIED BY SP4 Jim/K...
ON 3/9/81 7074 P 22,330

KCIA info declassified per John E. Bacon 8/27/80

NOTE: This case involves a wire tap placed on the telephone of Dan Rowan of the comedy team of Rowan and Martin by Arthur James Balletti and J. W. Harrison. Robert Maheu, a former Bureau Agent, is a possible subject in this case in that he claimed he ordered the coverage of Rowan in behalf of the CIA's efforts to obtain intelligence information in Cuba. Colonel Sheffield Edwards on 5-3-61 advised that Maheu was used by the CIA as an intermediary with Sam Giancana relative to CIA's anti-Castro activities. The Department by memorandum dated 1-31-62 requested that we reinterview Colonel Edwards to determine whether the CIA would object to the institution of criminal prosecution in which Robert Maheu might be a defendant.

- Tolson _____
- Belmont _____
- Mohr _____
- Callahan _____
- Conrad _____
- DeLoach _____
- Evans _____
- Malone _____
- Rosen _____
- Sullivan _____
- Tavel _____
- Trotter _____
- Tele. Room _____
- Ingram _____
- Gandy _____

MAILED 25
FEB 9 1962
FBI

Classified by
Exempt from automatic
downgrading and
declassification
6049
Jim/K...
TOP SECRET

FEB 21 1962

FEB 20 1962 TELETYPE UNIT

RECEIVED
COMMUNICATIONS SECTION
FEB 11 1962

Office Memorandum • UNITED STATES GOVERNMENT

TO : Director, Federal Bureau of Investigation

DATE: March 19 1962

FROM : ^{HJM} Herbert J. Miller, Jr., Assistant Attorney General
Criminal Division

HJM:JWB:cf

82-46-5

SUBJECT: Arthur James Balletti;
Unknown Subject, aka J. W. Harrison
Unauthorized Publication or Use of Communications

Reference is made to your memorandum of February 9, 1962.

It is requested that the facts of this matter be made available to the Central Intelligence Agency and that that Agency be requested to advise specifically whether it would or would not object to the institution of criminal prosecution against the subjects, Balletti, Maheu, and an unknown subject (aka J. W. Harrison), for conspiracy to violate the "Wire Tapping Statute".

REC-97

100-1201-84

MAR 20 1962

16

~~TOP SECRET~~

EX 160

automatic

SLX

Handwritten notes:
3
JWH
CIA
13
Vine
102

~~X~~

UNITED STATES GOVERNMENT

Memorandum

Tolson	✓
Belmont	✓
Mohr	✓
DeLoach	✓
Evans	✓
Malone	✓
Rosen	✓
Sullivan	✓
Tavel	✓
Trotter	✓
Tele. Room	✓
Holmes	✓
Gandy	✓

TO : Mr. Belmont

DATE: 3/23/62

FROM : A. Rosen

SUBJECT: ARTHUR JAMES BALLETTI;
UNKNOWN SUBJECT, aka J. W. Harrison
UNAUTHORIZED PUBLICATION OR USE
OF COMMUNICATIONS

CE

This case involves a wire tap placed on the telephone of Dan Rowan by Arthur James Balletti and J. W. Harrison. Robert Maheu, a former Bureau Agent, is a possible subject in that he claimed he ordered coverage of Rowan in behalf of the Central Intelligence Agency's (CIA) efforts to obtain intelligence information in Cuba and CIA verified that Maheu had been retained by them. The Department requests that we contact CIA to determine specifically whether that agency would object to the institution of criminal prosecution against subjects Balletti, Maheu and an unknown subject (aka J. W. Harrison) for conspiracy to violate the "Wire Tapping Statute."

On 2/7/62, at the specific request of the Department, personal contact was made with CIA to determine whether CIA would object to prosecution of Maheu. A CIA spokesman said at that time that CIA would object to any prosecution which would necessitate the use of CIA personnel or CIA information. He added that the Government would be embarrassed by the introduction of any evidence concerning CIA's operation.

ACTION

Since prosecutive policy is involved and in view of CIA's previous indication that the Government could be embarrassed, it is felt that this should be resolved in writing. Attached for approval is a letter to CIA. The letter is to be delivered by liaison.

Enclosure

JWH:mc
(6)

REC-44

104-1211-85

18 MAR 29 1962

(See page two for Background)

REC'D REC UNIT

Memorandum to Mr. Belmont
Re: ARTHUR JAMES BALLETTI

BACKGROUND

An extensive investigation has been conducted by the Bureau concerning a telephone tap placed on the telephone of Dan Rowan of the comedy team of Rowan and Martin by Arthur James Balletti and J. W. Harrison.

Balletti, who is employed by a private investigating agency admitted to having been assigned to surveil Rowan in Las Vegas, Nevada, and was accompanied by J. W. Harrison, not further known to him, who was supplied by Robert Maheu, a former Bureau Agent. Rowan was reportedly engaged to Phyllis McGuire of the McGuire Sisters trio who was allegedly a girl friend of Sam Giancana. Giancana is under investigation as a top hoodlum by the Chicago Office.

Maheu, who reportedly authorized the wiring of Rowan's room, claimed that he ordered coverage of Rowan in behalf of the CIA's efforts to obtain intelligence information in Cuba through the hoodlum element, including Sam Giancana, who had interests in Cuba. Colonel Edwards of the CIA on 5/3/61 advised that Maheu was used as an intermediary with Sam Giancana relative to CIA's anti-Castro activities.

Department on 1/31/62 requested that we contact Colonel Edwards to determine whether the CIA would object to institution of a criminal prosecution in which Robert Maheu might be a defendant. CIA replied that they would object to any prosecution which would necessitate the use of CIA personnel or CIA information.

The Department now requests that we recontact Colonel Edwards to determine specifically whether the CIA would or would not object to the institution of criminal prosecution against the subjects Balletti, Maheu and Harrison for conspiracy to violate the "Wire Tapping Statute."

BY LIAISON

139-1201-85

REC-44

Date: March 23, 1962

To: Director
Central Intelligence Agency

Attention: Director of Security

From: John Edgar Hoover, Director

Subject: ARTHUR JAMES BALLETTI, Et al.
UNAUTHORIZED PUBLICATION OR USE
OF COMMUNICATIONS

b3 per CIA
[Redacted]
3/23/62
FBI

MAR 23 11 53 AM '62
REC'D-READING ROOM

This case involves a wire tap placed on the telephone of Dan Rowan of the comedy team of Rowan and Martin by Arthur James Balletti and J. W. Harrison. Balletti was employed by Edward DuBois, who runs a private investigating agency in Miami, Florida. Balletti admits to having been assigned to surveil Rowan in Las Vegas, Nevada, and was accompanied by one J. W. Harrison, not further identified, who was supplied by Robert Maheu, who also conducts private investigations. Dan Rowan was reportedly engaged to Phyllis McGuire of the McGuire Sisters trio, who was also reportedly a girl friend of Sam Giancana. Giancana is a hoodlum.

Maheu claimed that he ordered coverage of Rowan in behalf of Central Intelligence Agency's (CIA) efforts to obtain intelligence information in Cuba through the hoodlum element, including Sam Giancana, which had interests there. Maheu said he was put in contact with Giancana in connection with these intelligence activities through John Roselli, a Los Angeles hoodlum. Maheu authorized wiring of Rowan's room and discussed the matter with John Roselli.

- Tolson _____
- Belmont _____
- Mohr _____
- Callahan _____
- Conrad _____
- DeLoach _____
- Evans _____
- Malone _____
- Rosen _____
- Sullivan _____
- Tavel _____
- Trotter _____
- Tele. Room _____
- Holmes _____
- Gandy _____

WLM:mc:jlt
(8)

MAR 23 8 15 AM '62

Note: See memo Rosen to Belmont, 3/23/62, WLM:mc.
RECEIVED

GROUP 1
Excluded from automatic
downgrading and
declassification

MAIL ROOM TELETYPE UNIT

R [Signature]

**Director
Central Intelligence Agency**

At the request of the Criminal Division of the Department of Justice, this matter was discussed with the CIA Director of Security on February 7, 1962, and we were advised that your agency would object to any prosecution which would necessitate the use of CIA personnel or CIA information. We were also informed that introduction of evidence concerning the CIA operation would be embarrassing to the Government.

The Criminal Division has now requested that CIA specifically advise whether it would or would not object to the initiation of criminal prosecution against the subjects, Balletti, Maheu, and the individual known as J. W. Harrison for conspiracy to violate the "Wire Tapping Statute."

An early reply will be appreciated in order that we may promptly inform the Criminal Division of CIA's position in this matter.

Memorandum

Belmont	
Mohr	
Callahan	
Conrad	
DeLoach	
Evans	
Malone	
Rosen	
Sullivan	
Tavel	
Trotter	
Tele. Room	
Holmes	
Gandy	

TO : MR. SULLIVAN

DATE: April 5, 1962

FROM : D. J. BRENNAN

SUBJECT: ARTHUR JAMES BALLETTI, ET. AL.
UNAUTHORIZED PUBLICATION OR USE
OF COMMUNICATIONS

Reference is made to Bureau letter to Central Intelligence Agency (CIA) dated March 23, 1962. This case involves a wire tap placed on the telephone of Dan Rowan of the comedy team of Rowan and Martin by Arthur James Balletti and J. W. Harrison. Robert Maheu, former Bureau Agent, is a possible subject in this case in that he claimed he ordered the coverage of Rowan in behalf of CIA's efforts to obtain intelligence information on Cuba. We were informed by CIA in May, 1961, that Maheu was used by that Agency as an intermediary relative to CIA's anti-Castro activities. On February 7, 1962, Colonel Sheffield Edwards, CIA, advised us that his Agency would object to any prosecution in this matter if CIA personnel or CIA information were to be used. He pointed out that an introduction of any evidence concerning the CIA operation would be most embarrassing to the U. S. Government.

On April 2, 1962, Colonel Edwards advised the Liaison Agent that he had no desire to impose any restriction which might hinder efforts to prosecute any individual but he is firmly convinced that prosecution of Maheu undoubtedly would lead to exposure of most sensitive information relating to the abortive Cuban invasion of April, 1961, and would result in most damaging embarrassment to the U. S. Government. He stated that in view of this his Agency objects to prosecution of Maheu.

This is an outrage.

ACTION:

The above information is being directed to the attention of the Investigative Division.

- SJP:dan (6)
- 1 - Mr. Belmont
 - 1 - Mr. Sullivan
 - 1 - Mr. Rosen
 - 1 - Liaison
 - 1 - Mr. Papich

139-1201

THE CONTINUED...
OF THE...
has been...
THIS...
...

EX-105

REC-23

10 APR 12 1962

*MEMO FILED...
4/10/62
MIRAC*

PERS. REC. UNIT

April 10, 1962

Mr. Herbert J. Miller, Jr.
Assistant Attorney General

~~CONFIDENTIAL~~

Director, FBI

REC-23

39-1201-86
ARTHUR JAMES BALLETTI, et al.
UNAUTHORIZED PUBLICATION OR
USE OF COMMUNICATIONS

Reference is made to your memorandum dated March 19, 1962, your file number 82-46-5.

Colonel Sheffield Edwards, Director of Security, Central Intelligence Agency, has now advised that he has no desire to impose any restriction which might hinder efforts to prosecute any individual, but he is firmly convinced that prosecution of Maheu undoubtedly would lead to exposure of most sensitive information relating to the abortive Cuban invasion in April, 1961, and would result in most damaging embarrassment to the United States Government. He added that in view of this his agency objects to the prosecution of Maheu.

It is suggested that should you have any further inquiry in this regard you may wish to communicate directly with the Central Intelligence Agency. No further action will be taken by the FBI unless specifically requested by the Department.

*Downgraded 12/17/71
per CIA Let. 12/2/76*

WLM:mc
(8)

NOTE: Prepared in accordance with Brennan to Sullivan memo 4/5/62.

MAILED 10
APR 14 1962
COMM-FBI

GROUP 1
Excluded from automatic
downgrading and
declassification

Obs

- Tolson _____
- Belmont _____
- Mohr _____
- Callahan _____
- Conrad _____
- DeLoach _____
- Evans _____
- Malone _____
- Rosen _____
- Sullivan _____
- Tavel _____
- Trotter _____
- Tele. Room _____
- Holmes _____
- Gandy _____

~~CONFIDENTIAL~~

APR 10 4 18 PM '62

REC'D COMM-FBI

Deleted Copy Sent F. TAYLOR BRANCH
by Letter Dated 12/15/76
Per FOIPA Request HR

APR 23 1962
XEROX

MAIL ROOM TELETYPE UNIT

UNITED STATES GOVERNMENT

Memorandum

Tolson	_____
Belmont	_____
Mohr	_____
Waltman	_____
Conrad	_____
DeLoach	_____
Evans	_____
Malone	_____
Rosen	_____
Sullivan	_____
Tavel	_____
Trotter	_____
Tele. Room	_____
Holmes	_____
Gandy	_____

TO : MR. SULLIVAN

DATE: April 13, 1962

FROM : D. J. BRENNAN

SUBJECT: ARTHUR JAMES BALLETTI, ET. AL.
UNAUTHORIZED PUBLICATION OR USE
OF COMMUNICATIONS

Reference is made to my memorandum dated April 5, 1962, advising that Central Intelligence Agency (CIA) was opposed to prosecution of Robert Maheu since such action could lead to exposure of most sensitive information relating to the Cuban invasion of April, 1961, and could result in damaging embarrassment to the U. S. Government.

For your information, Colonel Sheffield Edwards, Director of Security, CIA, advised that his Agency was giving serious consideration to conferring with the Department of Justice concerning this matter. It is Edwards' understanding that if this is done contact will be made with the Attorney General or Mr. Herbert J. Miller, Jr., of the Criminal Division.

ACTION:

The above information is being directed to the attention of the General Investigative Division.

SJP:ban
(7)

- 1 - Mr. Belmont
- 1 - Mr. Sullivan
- 1 - Mr. Rosen
- 1 - Mr. McGowan
- 1 - Liaison
- 1 - Mr. Papich

APR 18 1962

ST-104

61 APR 20 1962

Memorandum

TO : Director, Federal Bureau of Investigation

DATE: March 19 1963

HJM:JCK:sh
82-46-5

FROM : Herbert J. Miller, Jr.,
Assistant Attorney General
Criminal Division

SUBJECT: Arthur James Balletti, et al.
Unauthorized Publication or Use of Communications

*made
copy*

Subsequent to our latest correspondence on the captioned subject this Division learned that the Central Intelligence Agency had placed a Top Secret classification on certain aspects of the matter. Also, it has been brought to my attention that some sensitive material may have been provided to your Bureau and other agencies on a non-classified basis. In view of this situation I have had the file reviewed to determine whether any of the material therein should be classified. As a result of this review I have concluded that the following materials should be classified as Top Secret to comport with the Central Intelligence Agency's classification.

MA

U.S. DEPT. OF JUSTICE

1. Letterhead memorandum, dated April 20, 1961, captioned as above.
2. Your memorandum addressed to the Attorney General, dated May 22, 1961, and captioned as above.
3. Report of Special Agent [redacted] dated June 6, 1961, at Washington, D. C. *(11-1-61, 6-30-61)*
4. Report of Special Agent [redacted] dated July 20, 1961, at Los Angeles, California.
5. Report of Special Agent [redacted] dated July 20, 1961, at Los Angeles, California.
6. Report of Special Agent [redacted] dated August 16, 1961, at Las Vegas, Nevada.
7. Report of Special Agent [redacted] dated September 7, 1961, at Las Vegas, Nevada.
8. My memorandum to you on this subject, dated January 31, 1962.
9. Your memorandum to me on this subject, dated February 9, 1962.

67C

REC-35 139-1201-28

*11-1-61
11-1-61
3/12/63*

*Arthur Balletti
was
3/12/63*

RA

Sydney

10. My memorandum to you on this subject, dated March 19, 1962.

11. Your memorandum to me on this subject, dated April 10, 1962.

PA

SAC, Las Vegas (139-1)

3/21/63

139-1201-48

Director, FBI

REC-35

EX-115

ARTHUR JAMES BALLETTI, AKA, ET AL.;
WFUC
OO: LAS VEGAS

Enclosed herewith for each office is a copy of a self-explanatory Departmental memorandum dated 3/16/63.

Each office should promptly place the "Top Secret" classification on the various communications as instructed by the Department. You are likewise responsible for advising other offices, such as USA, of the Department's instructions.

It will not be necessary to advise the Bureau that the Department's instructions have been complied with.

Enclosure

- 2 - Chicago (139-109) (Enclosure)
- 2 - Los Angeles (139-77) (Enclosure)
- 2 - Miami (139-63) (Enclosure)
- 2 - WFO (139-91) (Enclosure)

WAS:sjs
(12)

MAILED 20
MAR 21 1963

NOTE: We conducted an extensive investigation concerning a telephone tap placed on the telephone of Dan Rowan of the Comedy team of Rowan and Martin. Our investigation developed that Robert Maheu, a former FBI Agent, ordered the coverage of Rowan in behalf of CIA in an effort to obtain intelligence info in Cuba. Rowan was reportedly engaged to Phyllis McGuire of the McGuire Sisters trio and she allegedly was a girlfriend of Sam Giancana. He is a top hoodlum under investigation by the Chicago Office and was believed to have many contacts in Cuba as a result of gambling interest there. Prosecution in this matter was not undertaken because there was a lack of sufficient evidence that info intercepted was ever disclosed and also due to the possible embarrassment of CIA. It is noted that CIA confirmed that Maheu had been retained for the purpose of developing intelligence info through Giancana.

- Tolson _____
- Belmont _____
- Mohr _____
- Casper _____
- Callahan _____
- Conrad _____
- DeLoach _____
- Felt _____
- Gale _____
- Rosen _____
- Sullivan _____
- Tavel _____
- Trotter _____
- Tele. Room _____
- Holmes _____
- Gandy _____

MAIL ROOM TELETYPE UNIT

WAS

[Handwritten initials]

[Handwritten signature]

3/22/63

AA
-115-35

139-1201-88

Airtel

To: SAC, Las Vegas (139-1)

From: Director, FBI

ARTHUR JAMES BALLETTI, AKA, ET AL.;

UPUC

OO: LAS VEGAS

ReBulet 3/21/63.

Reference is made to the Departmental memo dated 3/19/63 which was enclosed with referenced letter.

It is noted under Numbers 4 and 5 that the Department refers to the same report and it appears that Number 4 should have referred to the report of E. [redacted] dated 6/30/61 at Los Angeles. This matter has been discussed with the Department and the Department is presently reviewing its file and you will be advised of the results.

b7c

- 1 - Chicago (139-105)
- 1 - Los Angeles (139-77)
- 1 - Miami (139-63)
- 1 - WFO (139-31)

MAILED 3
MAR 22 1963
COMM-FBI

1 yr old
2467
WAS

WAS:sjs
(8)

NOTE: On 3/22/63, it was pointed out to Mr. Peterson of the Criminal Division that the Departmental memo under Nos. 4 and 5 referred to the same report. A review of the Bufiles indicates that the Department probably meant for No. 4 the report of SA [redacted] dated 6/30/61 which refers to CIA interest in this matter. Mr. Peterson advised that Departmental Attorney John Keeney is presently out of the city but he will have him review the matter upon his return and advise the Bureau.

b7c

- Tolson _____
- Belmont _____
- Mohr _____
- DeLoach _____
- Casper _____
- Callahan _____
- Conrad _____
- Felt _____
- Gale _____
- Rosen _____
- Sullivan _____
- Tavel _____
- Trotter _____
- Tele. Room _____
- Holmes _____
- Gandy _____

62 MAR 28 1963

MAIL ROOM TELETYPE UNIT

WAS
137

Sullivan Mar 26

SAC, Las Vegas (139-1)

*07 LV
4-24-63
prot*

4/9/63

Director, FBI (139-1201)

✓
ARTHUR JAMES BALLETTI, AKA, ET AL.;
UPUC
(OO:LV)

ReBureau airtel 3/22/63.

As pointed out in reairtel the Departmental memorandum dated 3/19/63, under numbers four and five were referring to the same report. The Department has reviewed its file and now advises that number four should have referred to the report of SA [redacted] dated 6/30/61 at Los Angeles.

10-1

b7c
L

In accordance with Departmental instructions this report should also receive a TOP SECRET classification.

- 1 - Chicago (139-105)
- 1 - Los Angeles (139-77)
- 1 - Miami (139-63)
- 1 - Washington Field (139-31)

WAS:vhm
(8)

NOTE: On 4/8/63 Departmental Attorney John Keeney advised the above information. This was pointed out to the Department on 3/22/63.

139-1201-81

- Tolson _____
- Belmont _____
- Mohr _____
- Casper _____
- Callahan _____
- Conrad _____
- DeLoach _____
- Evans _____
- Malone _____
- Rosen _____
- Sullivan _____
- Tavel _____
- Trotter _____
- Tele. Room _____
- Holmes _____
- Gandy _____

MAILED 27
APR 9 - 1963
COMM-FBI

WAS REC-38

50 APR 15 1963

EX-112

MAIL ROOM TELETYPE UNIT

5/9

UNITED STATES GOVERNMENT

Memorandum

TO : Director, FBI (139-1201)

DATE: 4/17/63

Handwritten initials

FROM : SAC, Las Vegas (139-1)

-C-

SUBJECT: ARTHUR JAMES BALLETTI, aka; ETAL
UPUC
OO: LV

ReBulets 3/21/63 and 4/9/63.

The file in the Las Vegas Division in this matter has been reviewed and those communications set forth in Department Memorandum dated 3/19/63 have been stamped Top Secret.

Also a letter has been forwarded to the USA at Las Vegas listing those communications in his possession, with Department instructions that they should be classified as Top Secret.

For information of the Bureau, only the following listed items set forth in the Department Memorandum are in the Las Vegas file: ITEMS 1, 3, 4, 5, 6, and 7.

- 2 - Bureau
- 1 - Chicago (139-105)
- 1 - Los Angeles (139-177)
- 1 - Miami (139-63)
- 1 - Washington Field (139-31)
- 1 - Las Vegas

MBP:csi
(7)

U.S. DEPT. OF JUSTICE

APR 15 05 11 1963

SECRET

REC-73 139-1201-90

APR 25 1963

11 APR 19 1963

Handwritten mark resembling a 'Y'

Handwritten initials

UNITED STATES GOVERNMENT

MEMORANDUM FOR THE DIRECTOR

Memorandum

- 1 - Mr. DeLoach
- 1 - Mr. Gale
- 1 - Mr. Wick

Tolson	
Belmont	
Mohr	
Wick	
DeLoach	
Casper	
Callahan	
Conrad	
Felt	
Gale	
Rosen	
Sullivan	
Tavel	
Trotter	
Tele. Room	
Holmes	
Gandy	

TO : W. C. Sullivan

DATE: March 6, 1967

FROM : W. R. Wannall

- 1 - Mr. Sullivan
- 1 - Mr. Papich
- 1 - Mr. Wannall
- 1 - Inspector

SUBJECT: CENTRAL INTELLIGENCE AGENCY'S
OPERATIONAL SECURITY MATTERS TO
COLA TO ASSASSINATE CASTRO

In accordance with instructions, attached letter has been prepared for Attorney General setting forth all data in our files concerning captioned matter. Briefly, information being furnished is as follows:

Matter first came to our attention in Spring of 1961 in connection with our investigation of violation of Unauthorized Publication or Use of Communications Statute on the part of Arthur James Balletti, arrested in Las Vegas, Nevada, by local authorities on wire tapping charge. Wire tap involved was on telephone of Dan Rowan, member of Rowan and Martin comedy team. Rowan at the time reportedly was engaged to Phyllis McGuire, girl friend of top hoodlum Sam Giancana and member of McGuire Sisters singing trio.

Through our investigation we determined involvement of Robert A. Maheu, private detective, who stated coverage on Rowan instituted in behalf of Central Intelligence Agency (CIA) efforts to obtain Cuban intelligence data through hoodlum element, including Sam Giancana. Maheu was in contact with Giancana through services of John Roselli, another hoodlum, and Maheu authorized wiring of Rowan's room.

We checked matter with CIA on 5/3/61 and learned CIA was utilizing Maheu as intermediary with Sam Giancana relative to CIA's "dirty business" anti-Castro activities. CIA insisted it did not give Maheu any instructions relative to use of technical installations. By letter 5/22/61 we furnished former Attorney General Kennedy a memorandum containing a rundown on CIA's involvement in this. The originals of the letter and memorandum were returned to us for filing purposes. A copy of that memorandum is being attached to instant letter being sent to Attorney General.

On 5/8/61 Kennedy discussed with the Director a number of matters, including transmission by CIA that Robert Maheu had been

Enclosure 3-3-67

GCH:ams

(3)

CONTINUED - OVERNOT RECORDED

170 MAR 14 1967

Memorandum for Mr. Sullivan
Re: CENTRAL INTELLIGENCE AGENCY'S
INTENTIONS TO SEND HONOLULU TO
CUBA TO ASSASSINATE CASTRO

hired by that Agency to approach San Giancana to have Castro assassinated at a cost of \$50,000. Kennedy stated he had issued orders that CIA should never undertake such steps again without first checking with Department of Justice and stated because of this matter it would be difficult to prosecute Giancana or Maheu then or in the future.

We learned on 6/20/63 from CIA that its contacts with John Roselli (Maheu's link with Giancana) had continued up until that time, when they were reportedly cut off.

It appears Roselli is using his prior connections with CIA to his best advantage. In May, 1966, when Bureau Agents endeavored to interview him he immediately flew to Washington and informed his former CIA intermediary. The current Director of Security, CIA, has advised through liaison channels that Roselli has CIA in an unusually vulnerable position and Roselli would have no qualms about embarrassing CIA to serve his own interests. In furnishing this information we were asked that it be held within this Bureau on a strictly need-to-know basis. We have, however, included it in the attached proposed letter to the Attorney General noting this CIA specific restriction.

We have two other references in our files to the over-all above information which we have included in the letter. One relates to a statement by Giancana in October, 1960, that he had met with an individual who was to assassinate Castro in November, 1960. The other is an article in the 8/16/63 issue of the "Chicago Sun Times" reporting that CIA agents had contacted Giancana to obtain Cuban intelligence.

ACTION:

If approved, attached letter will be sent to the Attorney General, with a copy for the Deputy Attorney General.

han
WAD
*The Attorney General -
asked for this information
on Friday, 8/15/67 -
WAD*

ROUTE IN ENVELOPE

TOP SECRET

- 1 - Mr. DeLoach
- 1 - Mr. Gale
- 1 - Mr. Wick
- 1 - Mr. Sullivan

The Attorney General

March 6, 1967

Director, FBI

- 1 - Mr. Papich
- 1 - Mr. Wannall
- 1 - Inspector

CENTRAL INTELLIGENCE AGENCY'S
INTENTIONS TO SEND HOODLUMS TO
CUBA TO ASSASSINATE CASTRO

Our files contain the following information concerning the captioned matter, much of which has been furnished by the Central Intelligence Agency (CIA) on a strictly highly confidential "need-to-know" basis. In view of this, it is requested that it be handled on a most restrictive basis.

This matter first came to our attention in the Spring of 1961 in connection with our investigation of a violation of the Unauthorized Publication or Use of Communications Statute on the part of Arthur James Balletti, who had been arrested by local authorities in Las Vegas, Nevada, on a local wire tapping charge. Balletti and another unidentified individual in October, 1960, had reportedly placed a wire tap on the telephone of Sam Rowan, a member of the comedy team of Rowan and Martin. Rowan at the time reportedly was engaged to Phyllis McGuire of the well-known McGuire Sisters singing trio who was also known to be a girl friend of Sam Giancana, a top hoodlum.

During the course of the Balletti investigation it was ascertained that Robert A. Maheu, a private detective, was involved. Maheu during interview claimed he ordered coverage of Rowan in behalf of CIA's efforts to obtain intelligence information in Cuba through the hoodlum element, including Sam Giancana, which had interests there. Maheu said he was put in contact with Giancana in connection with these intelligence activities through John Roselli, a Los Angeles hoodlum. Maheu stated also that he authorized the wiring of Rowan's room and had discussed the matter with Roselli.

The essence of the above was furnished to former Attorney General Robert F. Kennedy by letter dated May 22, 1961, which enclosed a memorandum of the same date containing data made available on May 3, 1961, by Colonel Sheffield Edwards, who at that time was Director of Security at CIA, regarding his utilization of Maheu in connection with anti-Castro activities. Also our files show that Mr. Kennedy returned the original of our letter and its enclosed memorandum dated May 22, 1961.

Handwritten notes:
See file in ...
4/24/67
file

MAR 5 1967
COMM-FBI

Mr. Tolson _____
Mr. DeLoach _____
Mr. Mohr _____
Mr. Bishop _____
Mr. Casper _____
Mr. Callahan _____
Mr. Conrad _____
Mr. Felt _____
Mr. Gale _____
Mr. Rosen _____
Mr. Sullivan _____
Mr. Tavel _____
Mr. Trotter _____
Tele. Room _____
Miss Holmes _____
Miss Gandy _____

GCM:ams

SEE NOTE, PAGE 4

TOP SECRET

GROUP 1
Excluded from automatic
downgrading and
declassification

Handwritten initials:
db
W
H
W

The Attorney General

to us for filing purposes, a copy of the May 22, 1961, memorandum is attached hereto for your information.

You will note that Colonel Edwards advised he personally contacted Robert Mahou during the Fall of 1960 for the purpose of using Mahou as a "cutout" in contacts with Sam Giancana in connection with CIA's clandestine efforts against Castro. Colonel Edwards stated that Giancana's activities were completely "backstopped" by Mahou, who would frequently report Giancana's actions and information to Edwards. No details or methods used by Mahou or Giancana in accomplishing their missions were reported to him, according to Edwards, as such involved "dirty business," of which Colonel Edwards could not afford to have knowledge. Accordingly, he said he had no prior knowledge of the above-mentioned wire tapping by Balletti.

Further with respect to this matter, I was informed of the following on a highly confidential basis by former Attorney General Kennedy during a conference in my office on May 9, 1962:

He indicated that a few days prior thereto he had been advised by CIA that Robert A. Mahou had been hired by CIA to approach Sam Giancana with a proposition of paying \$150,000 to hire some gunmen to go into Cuba and kill Castro. He further stated CIA admitted having assisted Mahou in making the "bugging" installation in Las Vegas (referred to above) which uncovered this clandestine operation and for this reason CIA could not afford to have any action taken against Giancana or Mahou. Mr. Kennedy stated that upon learning CIA had not cleared its action in hiring Mahou and Giancana with the Department of Justice he issued orders that CIA should never again take such steps without first checking with the Department of Justice.

Mr. Kennedy further advised that because of this matter it would be very difficult to initiate any prosecution against Giancana, as Giancana could immediately bring out the fact the United States Government had approached him to arrange for the assassination of Castro. He stated the same was true concerning any action we might take against Mahou for any violation in which he might become involved.

On June 20, 1963, Mr. William Harvey, an official of CIA, advised that he had held a meeting with John Rosolli (referred to above as Mahou's link with Giancana) for the purpose of closing out the entire matter with which Rosolli had been involved. In this connection, Harvey stated that CIA had

The Attorney General

established contact with Roselli in "early 1961" with respect to a sensitive operation against Castro. Harvey said that for all intents and purposes the operation was discontinued and canceled after the ill-fated Bay of Pigs invasion in April, 1961, but Roselli had not been completely cut off, as he periodically indicated he was in a position to be of assistance.

It appears Roselli has since that time, nevertheless, used his prior connections with CIA to his best advantage. For example, in May, 1960, when contacted by Agents of this Bureau in connection with our current investigation of his activities he refused to talk and immediately flew to Washington, D. C., and consulted with Colonel Sheffield Edwards, who is now retired from CIA. Colonel Edwards in turn advised CIA, which told us. Mr. Howard J. Osborn, the present Director of Security, CIA, freely has admitted to us that Roselli has CIA in an unusually vulnerable position and that he would have no qualms about embarrassing CIA if it served his own interests. In furnishing this information, Mr. Osborn asked that it be held within this Bureau on a strictly need-to-know basis.

In light of the above information furnished us by CIA and former Attorney General Kennedy, it appears that data which came to our attention in October, 1960, possibly pertains to the captioned matter. At that time a source close to Giancana advised that during a conversation with several friends Giancana stated that Fidel Castro was "to be done away with very shortly." Giancana reportedly assured those present that Castro's assassination would occur in November, 1960, and that he had already met with the assassin-to-be on three occasions, the last meeting having taken place on a boat docked at the Fontainebleau Hotel, Miami Beach, Florida. Reportedly, Giancana claimed that everything had been perfected for the killing and the "assassin" had arranged with a girl, not further described, to drop a "pill" in Castro's drink or food.

Also of possible interest is a news article carried in the August 16, 1963, issue of the "Chicago Sun Times." This article carried the headline, "CIA Sought Giancana's Help For Cuba Spying," and it was reported therein that CIA agents had contacted Giancana in an effort to obtain Cuban intelligence after Castro came into power.

Enclosure

1 - The Deputy Attorney General (Enclosure)

~~TOP SECRET~~

The Attorney General

NOTE:

See cover memorandum Wannall to Sullivan, same caption,
March 6, 1967, GCM:ams.

Classified "Top Secret" inasmuch as information contained
herein is so classified by CIA.

- 4 -
~~TOP SECRET~~

FEDERAL BUREAU OF INVESTIGATION
FREEDOM OF INFORMATION/PRIVACY ACTS SECTION

SUBJECT: FIDEL CASTRO

FILE NUMBER: 92-3267 CROSS-REFERENCES

FEDERAL BUREAU OF INVESTIGATION

REPORTING OFFICE LOS ANGELES	OFFICE OF ORIGIN LOS ANGELES	DATE 6/27/61	INVESTIGATIVE PERIOD 6/5 - 23/61
TITLE OF CASE JOHN ROSELLI, aka		REPORT MADE BY [REDACTED] b7C	TYPED BY pai
CLASS. & EXT. BY REASON-FCIM II 1-2.4.2		CHARACTER OF CASE AR ALL INFORMATION CONTAINED HEREIN IS UNCLASSIFIED 702 pch/22, DATE 3/16/81 BY sp4-jun/kar	
DATE OF REVIEW		CIA info unclassified per John E. [REDACTED] 8/27/80	

REFERENCES:

b7C
Report of SA [REDACTED] dated 6/5/61, at Los Angeles.
Las Vegas airtel to Los Angeles, 6/1/61.

- P -

ADMINISTRATIVE: The identity of the Special Agents who conducted physical surveillances reported herein can be obtained from the IA Section of this file. *u*

The following individuals furnished information reported herein concerning [REDACTED]

b7C
b7D
OS
[REDACTED]

CP

APPROVED <i>[Signature]</i>	SPECIAL AGENT IN CHARGE	DO NOT WRITE IN SPACES BELOW	
COPIES MADE:	<ul style="list-style-type: none"> 3 - Bureau (92-3267) 1 - USA, Los Angeles (Attn: AUSA TIMOTHY M. THORNTON) 1 - Chicago (92-399) (Info) 2 - Las Vegas (92-467) 2 - Los Angeles (92-113) 	92-3267-109	REC-44
Dissemination Record of Attached Report		16 JUN 30 1961	EX 104
Agency	1 - Comm Div Dept	<i>[Signature]</i> STAT SECT.	
Request Recd.	0-4-5		
Date Fwd.	7/11/61		
How Fwd.			
By	1 room 4710		

66 JUL 11 1961

LA 92-113

[REDACTED]

b2
b7C
b7D
OS

[REDACTED]

Possible Involvement of JOHN ROSSELLI
in case entitled,
ARTHUR JAMES BALLETTI; UNSUB, aka,
J. W. Harrison, UPUC,
OO: Las Vegas
LA file 139-77, Bufile 139-1201

The following information concerning the captioned case is set out in the administrative section of this report inasmuch as it is not definitely known that ROSSELLI is actually involved in the above case. Facts indicating this possibility are set out below.)

On October 31, 1960, ARTHUR JAMES BALLETTI was arrested at the Riviera Hotel in Las Vegas, at which time he admitted that he had received instructions from Investigations, Inc., Miami, Florida, to surveil and record telephone conversations of DAN ROWAN, who was then staying at the Riviera Hotel. Investigation revealed that an unknown individual using the name J. W. HARRISON assisted BALLETTI in the placing of telephone surveillance in DAN ROWAN's room; that PHYLLIS MC GUIRE of the MC GUIRE singing act, was then keeping company with DAN ROWAN and DAN ROWAN has indicated that he intends to marry PHYLLIS MC GUIRE. PHYLLIS MC GUIRE has been a girl friend of SAM GIANCANA in the past.)

EDWARD L. DUBOIS of Investigations, Inc. advised he received a call from ROBERT MAHEU, a private investigator in Washington, D. C., requesting DUBOIS send two men to Las Vegas by October 26, 1960, for physical surveillance work.)

[REDACTED]

LA 92-113

Subsequently, according to DUBOIS, MAHEU told him to send only one man as he, MAHEU was going to send one man. Thereafter, DUBOIS sent BALLETTI and the unknown subject accompanied BALLETTI. U

During October, specifically from October 11 to 29, 1961, ROBERT A. MAHEU and a J. A. ROLLINS were registered at the Kenilworth Hotel, Miami Beach, Florida, and ROLLINS accompanied MAHEU. U

MAHEU has stated that ROLLINS is JOHN A. ROLLINS but refuses to further identify him. While at the hotel, ROLLINS was charged with two telephone calls to WH 3-1155, Chicago, Illinois, which is the telephone number of [REDACTED] a close friend and associate of JOHN ROSSELLI. He was also charged with a call to [REDACTED] telephone DI 7-6298, Woodland Hills, California. [REDACTED] is also a close friend and associate of ROSELLI. U

ROLLINS was charged also with a call to the Desert Inn Hotel, Las Vegas, Nevada, telephone DU 2-6000. ROSSELLI has received many telephone calls in the past at the Desert Inn Hotel. U

In view of the above calls, the possibility exists that ROSSELLI may be JOHN A. ROLLINS. U

THOMAS FOLEY, Las Vegas, Nevada, attorney, in the latter part of October 1960, received a telephone call from JAMES P. CANTILLON of the law firm of Cantillon and Cantillon, Beverly Hills, California, requesting that FOLEY represent BALLETTI and arrange for his bond, and CANTILLON personally guaranteed FOLEY's fee. It is noted that JAMES P. CANTILLON is JOHN ROSSELLI's attorney and a close associate of ROSSELLI. U

Information was received from Central Intelligence Agency that in their operation against FIDEL CASTRO in Cuba, ROBERT MAHEU in the fall of 1960 was contacted to act as a "cut out" in contacts with SAM GIANCANA on the basis that because of gambling activities in Cuba under the BATISTA government, GIANCANA might still have sources and contacts in

LA 92-113

Cuba which would be of value to CIA. ~~U~~

ROBERT MAHEU on interview on May 25, 1961, by Bureau Agents, stated that the original contact with GIANCANA in that matter was made by "JOHNNY" who MAHEU declined to identify. In this connection, it is noted that ROSSELLI is acquainted with a number of Chicago hoodlums and no doubt is acquainted with GIANCANA. U

MAHEU said that while working with GIANCANA, information was received that his interests in the Cuban situation was being disclosed by GIANCANA to other individuals. U

MAHEU stated that it was ascertained that GIANCANA was very much in love with PHYLLIS MC GUIRE of the MC GUIRE sisters act. It was believed, according to MAHEU that if GIANCANA had talked of MAHEU's interest in the Cuban situation that he might possibly have mentioned it to PHYLLIS MC GUIRE. It was also known that PHYLLIS MC GUIRE was a close personal friend of DAN ROWAN of the comedy team of ROWAN and MARTIN and he learned in October 1960 that ROWAN was working in Las Vegas and that PHYLLIS MC GUIRE was going to visit ROWAN in Las Vegas. U ~~U~~

MAHEU stated that he decided to have microphone coverage installed in ROWAN's room in Las Vegas; that he made this decision himself, and he arranged to have Investigations, Inc. send two men to Las Vegas to install and operate microphone coverage of ROWAN. He said it was his intention to have only microphone coverage and that BALLETTI and the UNSUB went too far in installing telephone coverage of ROWAN. ~~U~~

Information appears in this report that on April 29, 1961, ROSSELLI was charged with telephone call to JE 3-9655, Falls Church, Virginia, which is a number called by CANTILLON on November 1, 1960, for BOB MAHEU. On 5/20/61 he was charged with a call to JE 3-7277, Falls Church, Va., which is also a telephone number of ROBERT MAHEU. U

In connection with the BALLETTI investigation, leads have been set out to determine the subscribers to telephone numbers in Chicago, Illinois, and Miami, Florida, as set out in this report, which were charged to ROSSELLI during April 1961.

LA 92-113

BALLETTI has advised that while in Las Vegas in October 1960, he received instructions from MAHEU to contact T.W. RICHARDSON at the New Frontier Hotel and RICHARDSON would pay him \$1000 for the work being done by BALLETTI and the UNSUB in Las Vegas. U

T. W. RICHARDSON has denied knowing BALLETTI or paying any money to BALLETTI or anyone else in connection with this matter. It is noted that ROSSELLI has in the past contacted T. W. RICHARDSON. ROSSELLI also in the past has contacted ROBERT MAHEU. U

Leads are also outstanding in the BALLETTI investigation to reinterview MAHEU to determine if JOHN A. ROLLINS is identical with JOHN ROSSELLI. Also, leads have been set out to have ROSSELLI's handwriting compared by the FBI Lab with the signature of J. A. ROLLINS at the Kenilworth Hotel and the signature of J. W. HARRISON at the Riviera Hotel. U

The results of this investigation will be set out in future ROSSELLI reports and in the event it is determined that ROSSELLI actually is involved in this matter, the information will be incorporated in the ROSSELLI reports. U

INFORMANTS

Careful consideration has been given to each source concealed and T symbols were utilized only in those instances where the identities of the sources must be concealed. U

b2
b7C
b7D
OS

[REDACTED]

LA 92-113

LEADS

CHICAGO (INFORMATION)

One copy of this report was furnished to Chicago for information purposes inasmuch as they have outstanding investigation to conduct.

LAS VEGAS

At Las Vegas, Nevada (1) Determine the subscribers to telephone numbers DU 2-3666 and DU. 4-2936 to which numbers ROSSELLI was charged with toll calls on 4/23/61.

(2) At Golf Manor, Paradise Road, and through usual sources will ascertain background information concerning [REDACTED] with whom ROSSELLI is currently associated in Los Angeles.

b7C
OS
(3) Will review the Las Vegas file in the case of ARTHUR JAMES BALLETTI, mentioned above, to determine whether or not telephone number JE 3-7277, Falls Church, Virginia, is assigned to ROBERT MAHEU.

LOS ANGELES

At Los Angeles, California, Will follow and report investigation currently being conducted by the Los Angeles Office concerning ROSSELLI's activity.

FEDERAL BUREAU OF INVESTIGATION

REPORTING OFFICE LOS ANGELES	OFFICE OF ORIGIN LOS ANGELES	DATE 8/4/61	INVESTIGATIVE PERIOD 6/23 - 7/31/61
TITLE OF CASE JOHN ROSELLI, aka		REPORT MADE BY <i>b7c</i> [REDACTED]	TYPED BY BLR
ALL INFORMATION CONTAINED HEREIN IS UNCLASSIFIED <i>70SPM# 22,330</i> DATE <u>3/3/81</u> BY <u>SP4-jmm/KDZ</u> <i>CIA info unclass per Let John E. Bacon 8/27/80</i>		CHARACTER OF CASE AR <i>b7c</i>	

REFERENCES: Report of SA [REDACTED] at Los Angeles, 6/27/61; Phoenix letter to Los Angeles 6/28/61 (interoffice); Las Vegas airtels to Los Angeles 6/28, 30, 7/13 and 31/61 (interoffice); Las Vegas radiograms to Director and Los Angeles 7/6 and 13/61; Las Vegas teletype to Los Angeles 7/28/61.

-P-

ADMINISTRATIVE

The identity of the Special Agents who conducted physical surveillance reported herein can be obtained from the LA Section of this file. *u*

*b7c
b7D
OS*



APPROVED <i>WMS</i>	SPECIAL AGENT IN CHARGE	DO NOT WRITE IN SPACES BELOW	
COPIES MADE: 3 - Bureau (92-3267) 1 - USA, Los Angeles (Attn: AUSA TIMOTHY M. THORNTON) 1 - Chicago (92-399) (Info) 2 - Las Vegas (92-467) 2 - Los Angeles (92-113)		92-3267-111	REC-6 EX-107
Dissemination Record of Attached Report		AUG 8 1961	
Agency	<i>Crim Div Dept</i>	<i>STAT SECT</i>	
Request Recd.	<i>0-6-62</i>		
Date Fwd.	<i>8-14-61</i>		
How Fwd.			
By	<i>CC-154</i>		

DISSEMINATION RESTRICTED TO JUSTICE DEPARTMENT

Kept per CC to Senate Select Committee 9/16/75

55 AUG 16 1961

UNITED STATES DEPARTMENT OF JUSTICE
FEDERAL BUREAU OF INVESTIGATION

Copy to: 1 - USA, Los Angeles

Report of: [REDACTED] BLR

Office: LOS ANGELES, CALIFORNIA

Date: 6/7/61

Field Office File #: 92-113

Bureau File #: 92-3267

Title: JOHN ROSELLI [REDACTED]

Character: ANTIRACKETEERING [REDACTED]

Synopsis: ROSSELLI currently resides Las Vegas, Nevada. He continues to travel between Las Vegas and Los Angeles, residing for short periods of time at each city in apartments maintained by him. ROBERT MAHEU, private investigator, advised that in latter part of 1960 ROSSELLI contacted SAMUEL GIANCANA at MAHEU's request in connection with an investigation MAHEU was conducting for Central Intelligence Agency. In 10/60 during this investigation a microphone was placed on telephone in DAN ROWAN's hotel room at Rivera Hotel, Las Vegas. MAHEU said he discussed microphone installation with ROSSELLI prior to its installation but denied microphone installed at request of ROSSELLI or GIANCANA. At time of installation, according to MAHEU, DAN ROWAN was romantically involved with PHYLLIS MC GUIRE, MC GUIRE Sisters, who has been close in a romantic way with GIANCANA. ROSSELLI refused to discuss this matter with Bureau Agents. [REDACTED]

[REDACTED] CHICAGO, ILLINOIS, advised that he had no factual knowledge of ROSSELLI's interest in Las Vegas.

-P-

DETAILS: [REDACTED]

AT LOS ANGELES, CALIFORNIA

ROSSELLI's name is spelled with a "ss" throughout this report because this is the spelling he currently uses. U

ALL INFORMATION CONTAINED
HEREIN IS UNCLASSIFIED 70 FPAH
DATE 3/3/81 BY SP4-jm/ker 27 330

CIA Info unless per Let of
John E. Bacon 8/27/80

DISSEMINATION RESTRICTED TO JUSTICE DEPARTMENT

LA 93-113

TABLE OF CONTENTS

	<u>Page</u>
RESIDENCE	2 - 3
CONTACTS AND ASSOCIATES	4 - 13
[REDACTED]	4
ARTHUR JAMES BALLETTI	5 - 11
[REDACTED]	11 - 12
[REDACTED]	12
[REDACTED]	12
[REDACTED]	13
INFORMATION FURNISHED BY [REDACTED]	13 - 14
LEGITIMATE ENTERPRISES, INC.	14
TELEPHONE SERVICE	14
[REDACTED]	15 - 16

b7C
OS

b7D
OS

b7D
OS

[REDACTED]

LA 92-113

Information Concerning the
Case Entitled "ARTHUR JAMES
BALLETTI; UNSUB aka
J. W. HARRISON; UPUC"

Information concerning this matter is being set out
because ROSSELLI was involved in it. u

On October 31, 1960, ARTHUR JAMES BALLETTI was arrested
at the Rivera Hotel in Las Vegas, Nevada, at which time he
admitted that he had received instructions from Investigations,
Inc., Miami, Florida, to surveil and record telephone conversations
of DAN ROWAN, who was then staying at the Rivera Hotel. Investigati
revealed that an unknown individual using the name J. W. HARRISON
participated in the placing of the telephone surveillance in
DAN ROWAN'S room. u

It is noted that at this time ROWAN was keeping company
with PHYLLIS MC GUIRE of the MC GUIRE Sister singing act and
ROWAN later advised that he intended to marry PHYLLIS MC GUIRE.
PHYLLIS MC GUIRE had reportedly been the girl friend of
SAMUEL GIANCANA of Chicago. Information received during
July, 1960, from an informant in Las Vegas, indicates that
GIANCANA is again keeping company with PHYLLIS MC GUIRE. u

EDWARD L. DUBOIS of Investigations, Inc. advised
that in October, 1960, he received a telephone call from ROBERT
MAHEU, a private investigator, Washington D.C., requesting that
DUBOIS send two men to Las Vegas on October 26, 1961, for physical
surveillance work. Subsequently, according to DUBOIS, MAHEU
told him only to send one man as he, MAHEU, was going to send
one man. Thereafter, DUBOIS sent BALLETTI and the
unknown individual who used the name J. W. HARRISON accompanied
BALLETTI. u

During the period from October 11 to October 29, 1961,
ROBERT A. MAHEU and a J. A. ROLLINS were registered at the
Kenilworth Hotel, Miami Beach, Florida, and ROLLINS accompanied
MAHEU. MAHEU informed SAs of the FBI that J. A. ROLLINS was
JOHN A. ROLLINS but refused to further identify him. u

Investigation disclosed that while at the Kenilworth
Hotel, ROLLINS was charged with two telephone calls to telephone
number WH. 3-1155 in Chicago, Illinois, which is the telephone
number of [REDACTED] who has been identified in the
ROSSELLI investigation as a close friend and associate of ROSSELLI. u

LA 92-113

b7c ROLLINS was also charged with a telephone call to telephone number DU [REDACTED] California, which is the number of [REDACTED] who has also been identified as a close friend and associate of ROSSELLI.

ROLLINS was also charged with a telephone call to telephone number DU. 2-6000 which is the telephone number of the Desert Inn Hotel, Las Vegas, Nevada, where ROSSELLI had received many telephone calls in the past.

JAMES FOLEY, an attorney in Las Vegas, Nevada, advised that in the latter part of October, 1960, he received a telephone call from JAMES P. CANTILLON of the law firm of Cantillon and Cantillon, Beverly Hills, California, requesting that FOLEY represent BALLETTI and arrange for his bond. CANTILLON personally guaranteed FOLEY's fee. It is noted that JAMES P. CANTILLON is JOHN ROSSELLI's attorney and a close associate of ROSSELLI's.

Upon interview by SAs of the FBI, JAMES P. CANTILLON said that he first heard of the microphone incident when he received a call from a man in custody in Las Vegas whose name he did not recall. He said that the name BALLETTI was probably correct. He advised that he referred this man to THOMAS FOLEY an attorney in Las Vegas.

Further investigation revealed that Central Intelligence Agency (CIA) in connection with their operations concerning FIDEL CASTRO in Cuba contacted ROBERT MAHEU to act as "cutout" in contacts with SAM GIANCANA on the theory that GIANCANA through his gambling activities in Cuba under the Batista Government might still have sources and contacts in Cuba who could be of value to CIA. According to officials of CIA, this organization did not authorize the microphone surveillance on DON ROWAN.

On May 25, 1961, MAHEU advised SAs of the FBI that the original contact with GIANCANA after MAHEU had been requested by CIA to make contact with GIANCANA was made by "JOHNNY" who he declined to further identify.

b7c On June 29, 1961, MAHEU advised SAs [REDACTED] and [REDACTED] that he would verify "JOHNNY's" identity if the Agents named the man. When JOHN ROSSELLI's name was furnished to MAHEU he admitted that ROSSELLI was the "JOHNNY" he

LA 92-113

referred to and that ROSSELLI was also identical to J. A. ROLLINS who registered with him at the Kenilworth Hotel in Miami Beach, Florida, in October, 1960. u

Date

7/17/61

ROBERT MAHEU was interviewed at 190 North Canon Drive, Beverly Hills, California, on July 13, 1961. MAHEU was informed of his right to an attorney and that he did not have to answer questions and that anything he did say could be used against him in a court of law. MAHEU stated that in connection with the confidential assignment for Central Intelligence Agency (CIA) he had been in contact with SAMUEL GIANCANA and had received valuable assistance from GIANCANA, which, in turn, was furnished to CIA. MAHEU had reason to believe that GIANCANA may have disclosed information regarding the project and, in view of the sensitive nature of the project, he, MAHEU, decided to determine whether or not GIANCANA had actually talked to unauthorized persons. He was aware that GIANCANA was very close in a romantic way with PHYLLIS MC GUIRE of the Mc Guire Sisters Trio. He said that if GIANCANA had disclosed this information regarding project to anyone, he would have disclosed it to PHYLLIS MC GUIRE. He said that he was also aware that in the fall of 1960 the relations between PHYLLIS MC GUIRE and GIANCANA were strained and that PHYLLIS was romantically involved with DAN ROWAN, who was appearing at the Riviera Hotel in Las Vegas. He considered it very vital to determine whether or not GIANCANA was reliable and decided to order an installation on DAN ROWAN's room in an effort to determine whether or not GIANCANA had disclosed any information regarding the project to PHYLLIS MC GUIRE.

MAHEU stated that this decision was his own and that GIANCANA had no knowledge that the installation was made. He said that he did discuss this with JOHN ROSSELLI, since he felt obligated to discuss it with ROSSELLI, as ROSSELLI had been instrumental in putting him in contact with GIANCANA. MAHEU denied that the installation was made at the request of ROSSELLI or GIANCANA or for the benefit of either ROSSELLI or GIANCANA.

-8-

On 7/13/61 at Beverly Hills, California File # LA 92-113

by SAs [redacted] and [redacted] Date dictated 7/17/61
BLR

This document contains neither recommendations nor conclusions of the FBI. It is the property of the FBI and is loaned to your agency; it and its contents are not to be distributed outside your agency.

LA 92-113

He said that he did discuss his decision with ROSSELLI some time prior to ordering the installation but does not recall the specific date or place where he discussed the matter with ROSSELLI. He pointed out that he does not recall whether or not this occurred during October, 1960, when they were both registered at the Kenilworth Hotel in Miami Beach, Florida. He pointed out that he had met with ROSSELLI on a number of occasions and, therefore, does not recall the specific occasion in which he discussed his decision with ROSSELLI. He does not recall what comment ROSSELLI made when informed of his decision. U

MAHEU said that he requested EDWARD L. DUBOIS, Jr., a Miami Beach private investigator, to institute a technical surveillance of DAN ROWAN's room at the Rivera Hotel in Las Vegas, Nevada. He said that he does not recall what his specific requests were regarding the type of installation to be used, but had left this up to DUBOIS. He said that he was interested only in conversation within DAN ROWAN's room and had in mind the installation of a microphone and transmitter and not a telephone tap. He said, however, that he does not recall whether or not he specified not to make a telephone installation. He said that he does recall that he definitely did not request a physical surveillance of ROWAN. U

MAHEU stated that he does not know the identity of the unknown subject, also known as J. W. Harrison. He said that he definitely did not contact DUBOIS and tell DUBOIS that he would send one of his men. He insisted that DUBOIS furnished both men to handle this assignment in Las Vegas and that DUBOIS had charged him for transportation and time for two men. U

MAHEU repeated that he would take full responsibility for ordering the installation, that the installation was made for the reasons he had given above and in a previous interview, and definitely was not made at the request or for the benefit of JOHN ROSSELLI or SAMUEL GIANCANA. U

Date 7/13/61

JOHN ROSSELLI was contacted at Drucker's Hair-dressers for Men, 9740 Wilshire Boulevard, Beverly Hills, California. ROSSELLI was informed of his right to have an attorney and that he did not have to say anything and that anything he did say could be used against him in a court of law. u

ROSSELLI admitted that he has known ROBERT MAHEU for approximately five years. When asked if he knew SAM GIANCANA, ROSSELLI stated, "Let's discuss the weather. I do not care to answer any more questions." ROSSELLI stated that he knew of nothing illegal that MAHEU had done, but for any additional information regarding his association with MAHEU, the Agents should talk with MAHEU himself. u

-10-

On 7/7/61 at Beverly Hills, California File # LA 92-113
by b7c SAs [REDACTED] and [REDACTED] Date dictated 7/10/61
[REDACTED] BLR

LA 92-113

b7C
ROSSELLI was telephonically contacted by SA [REDACTED] at his Los Angeles apartment, 1251 Crescent Heights Boulevard, Los Angeles, on July 19, 1961, in an effort to arrange an interview. ROSSELLI advised that he did not care to discuss his association with MAHEU at any time with the FBI. u

[REDACTED]

[REDACTED]

[REDACTED]

[REDACTED]

b2
b7C
b7D

OS

LA 92-113

b2
b7D

[REDACTED] ROSSELLI
was in contact with ROBERT MAHEU (mentioned above in this
report) and they discussed a 16 millimeter film which
ROSSELLI identified as a "bare breast show". [REDACTED]
[REDACTED] this show had been tied up in some litigation.

[REDACTED]

[REDACTED]

[REDACTED]

[REDACTED]

b2
b7C
b7D

[REDACTED]

OS

[REDACTED]

[REDACTED]

[REDACTED]

FEDERAL BUREAU OF INVESTIGATION

REPORTING OFFICE LOS ANGELES	OFFICE OF ORIGIN LOS ANGELES	DATE 1/5/62	INVESTIGATIVE PERIOD 11/20 - 12/28/61
TITLE OF CASE JOHN ROSSELLI, aka		REPORT MADE BY [REDACTED] b7C	TYPED BY E
		CHARACTER OF CASE AR	

Handwritten notes:
 4/11/62
 E.H.
 H.S.
 H.S.
 H.S.
 H.S.
 H.S.
 H.S.
 H.S.
 H.S.

b7C
REFERENCES: Report of SA [REDACTED] 11/22/61 at Los Angeles
 Las Vegas airtels to Los Angeles, 11/21 and 12/26/61
 Los Angeles airtel to Las Vegas, 11/16/61
 Los Angeles teletype to Las Vegas, 11/30/61
 Los Angeles airtel to San Diego, 12/5/61
 San Diego letter to Los Angeles, 12/20/61
 Chicago airtel to Los Angeles, 12/6/61
 Las Vegas airtels to Bureau, 12/1 and 12/8/61.

-P- ALL INFORMATION CONTAINED
 HEREIN IS UNCLASSIFIED ⁷⁰²⁹⁴ #22,
 DATE 3/16/81 BY SP4-jm/KR
 *CIA Info unclassified per
 John E. Bacon 8/27/80

APPROVED <i>[Signature]</i>	SPECIAL AGENT IN CHARGE	DO NOT WRITE IN SPACES BELOW	
COPIES MADE: <i>n</i> 3 - Bureau (92-3267) 1 - USA, Los Angeles 2 - Las Vegas (92-467) 2 - Los Angeles (92-113)		92-3267-116	
		16 JAN 9 1962	
Dissemination Record of Attached Report		Notations	
Agency	<i>1 copy Dir Dept</i>	<i>[Signature]</i> STAT SECT.	
Request Recd.	<i>11-11-61</i>		
Date Fwd.	<i>11/17/61</i>		
How Fwd.	<i>[Handwritten]</i>		
By	<i>[Handwritten]</i>		

50 JAN 18 1962

ADMINISTRATIVE

b2
b7D
Some information is set out in the body of this report regarding matters discussed by JOHN ROSSELLI and SAM GIANCANA in Chicago, Illinois on December 6, 1961, as furnished by [REDACTED]. Efforts were made to generalize the information to conceal this source. During this conversation, ROSSELLI and GIANCANA discussed latest electronic devices, which discussion is set out below, and it appears to be pertinent to this investigation, but not of such a nature that it should be set out in the body of the report.

b7C
ROSELLI: Oh, I gave [REDACTED] that thing to bring up to you.
GIANCANA: It's no good. It's not the kind I was looking for. I was looking for the kind for the room, that would fit anyplace, a little disc, that you could lay anywhere.
ROSELLI: Oh, Electronics.
GIANCANA: Yeah. It's all right for sending. No, it's a receiver, but it's not a sender.
ROSELLI: It's a sender too. The thing that you have you can put between the door. And then you tune them in across the street.
GIANCANA: What I want is something really small....
ROSELLI: All right, here's one, you put on a wall, you..... I got a guy out there, this is what he brought me.
GIANCANA: You can't take a big mike like this and put it in a flat.
ROSELLI: Sure. You take it apart.
GIANCANA: If you take it apart, you're dead. You won't get the volume. As clear as..
ROSELLI: Well, we'll play with it. We got a guy, an electronic guy.

LA 92-113

GIANCANA: The main thing is....

ROSELLI: There is one thing, let me tell you what it is. The CIA has it, they have a thing, ...

GIANCANA: Like a cigarette.

ROSELLI: Yeah, but ... the FBI out there, somebody has got a portable....it takes conversations way out. The FBI has it. Electronics,..... spy system....Washington, now, and I told them, for Christ' sake, report on that thing. I gotta have it.....CIA.....

GIANCANA: If you can't get that, tell them to get the kind that you.....

ROSELLI: I got another guy in Los Angeles who's got an electronic cap kind of a thing... and he showed me that.....so I gotta find out what the smallest thing is. If you put it in there, you want to take it and get a receiver? And receive it where you're set up?

GIANCANA: Maybe a block, two blocks, three blocks.

ROSELLI: No, you can't go that far.

GIANCANA: We had one downtown about a year ago, a home made one, a little box, went to the hotel room (St. Clair Hotel) and stuck it in the guy's room, went down two blocks, you know where the St. Clair Hotel is at? Went two blocks away, sat in the car, then turned it on, and got all the conversation. Two blocks away. b7c ██████████ had it. ██████████

ROSELLI: How big was your receiver?

GIANCANA: Like a that's all. Box was only this big, maybe three by three. We were talking, bla, bla, bla,picked it up.

GIANCANA: Think about it.

LA-92-113

ROSELLI: Yeah. I'll work on it. BOBBY is in Washington...

GIANCANA: Well, JOHN, we'll see you tomorrow night.

ROSELLI: Wait a minute, now, you gonna be busy tomorrow?

GIANCANA: Yeah. Most of the day.

ROSELLI: Let me stay over, I'll send this guy back. Or maybe I'll keep him over an extra day.

GIANCANA: What the hell is the difference?

ROSELLI: All right, I'll meet with you tomorrow night. Seven o'clock. I want to tell you all these things, so you know. I can stay a week, a month, what do I care. But I'm trying to con this guy, that I'm staying over for him. Now, what I'll do is go downtown now. Do you know how to get in touch with me? I'm in 605, [REDACTED] Ambassador West. [REDACTED] Tomorrow you'll be busy all day.

GIANCANA: Tomorrow afternoon, I'll call you and I'll come down.

ROSELLI: Come down tomorrow afternoon and I can go with him tomorrow night. See? I'll wait in the hotel. It's in the California Suite. Come down about two, three o'clock.

Apparently GIANCANA is interested in obtaining a very small microphone which he can place in a room or an apartment to pick up conversations. ROSELLI mentions the CIA and apparently has some contact with CIA who is in a position to furnish ROSELLI with the latest information and/or equipment used to pick up conversations and either exhibited photographs of these devices or the actual devices themselves to GIANCANA. The situation which GIANCANA refers to in the St. Clair Hotel was one reported by [REDACTED] some time ago whereby MURRAY HUMPHREYS, [REDACTED] and apparently himself rigged up a home-made microphone and receiver, and placed it in the meeting room of the St. Clair Hotel after which they

sat in their car two blocks away and were able to pick up the conversation. ROSELLI then concluded by stating that he was staying at Room 605 at the Ambassador West Hotel with [REDACTED]

b7C

D.C.

It is noted that in the above conversation, ROSELLI states "BOBBY is in Washington." It is suggested that this may possibly be ROBERT MAHEU, who operates a private investigative group, and who is a friend of ROSELLI. It is recalled that MAHEU and ROSELLI were involved in an investigation wherein MAHEU was working for CIA, and was to establish contact with SAM GIANCANA.

It is further recalled that during some phase of this operation, a wire tap was put in the hotel room of DAN ROWAN at the Riviera Hotel in Las Vegas, at a time when DAN ROWAN was keeping company with PHYLLIS MC GUIRE, who is also a girl friend of SAM GIANCANA. It is further suggested as a possibility that MAHEU may be the contact through which ROSELLI obtains his information concerning electronic devices.

The individuals who furnished information set out in FD-302's in this report are as follows:

b7C
b7D
OS

[REDACTED]

[REDACTED]
advised that [REDACTED] was a guest at the Beverly Crest Hotel, occupying Room [REDACTED] from December 11 to December 14, 1961. He said that ROSSELLI was not a guest at the hotel during this period. He added that T. W. RICHARDSON, Riverside Hotel, Reno, Nevada, was also a guest at the hotel from December 11, 1961 to December 14, 1961, and that on December 11, 1961, RICHARDSON was charged with a telephone call to [REDACTED] at [REDACTED] at Las Vegas, Nevada. U

b7C
b7D

Information has previously been set out in this investigation that T. W. RICHARDSON is an acquaintance of JOHN ROSSELLI and information was previously reported concerning a wire tap on the phone of DAN ROMAN in Las Vegas in which an individual named ARTHUR JAMES BALLETTI was arrested and JOHN ROSSELLI was involved and interviewed. BALLETTI stated that he was told by ROBERT MAHEU, a private detective and friend of ROSSELLI that he, BALLETTI, was to contact T. W. RICHARDSON at the New Frontier Hotel, and that RICHARDSON would pay him \$1,000. RICHARDSON, upon interview by Bureau Agents, denied this. It is noted that [REDACTED] has interests in the New Frontier Hotel. U

b7C

As set out above, in this report, [REDACTED] stated that on December 14, 1961, JOHN ROSSELLI picked up [REDACTED] at the Beverly Crest Hotel and was driving a 1961 black Lincoln Continental automobile. With regard to this car, it is noted that the information has been previously reported in this investigation that the law firm of Cantillon and Cantillon have a 1961 Lincoln Continental registered to them and it is possible that this may have been the car used by ROSSELLI. U

b7C
b7D

[REDACTED]

December 11, 1961

[REDACTED]

b7C
b7D

OS

FEDERAL BUREAU OF INVESTIGATION

LOS ANGELES

LOS ANGELES

03/10/62

02/19/62 - 03/09/62

Title of Case
JOHN ROSELLI, aka.

Report made by [redacted] b7C
Typed by [redacted]

Character of Case
**ALL INFORMATION CONTAINED
HEREIN IS UNCLASSIFIED
DATE 3/11/81 BY SP4-jmk/ae**

XXXXXXXXXXXX CTA Info unclassified per
John E. Bacon 8/27/80
SUMMARY REPORT
SPECIAL SUMMARY REPORT

REFERENCE: Bureau airtel to New York 2/14/62 entitled
Criminal Intelligence Program.

Reports of SA [redacted] at Los Angeles
dated as follows:

- | | |
|----------|----------|
| 9/26/60 | 6/5/61 |
| 10/26/60 | 6/27/61 |
| 11/25/60 | 8/4/61 |
| 12/23/60 | 9/8/61 |
| 1/26/61 | 10/16/61 |
| 2/27/61 | 11/22/61 |
| 3/28/61 | 1/5/62 |
| 5/5/61 | 2/16/62 |

106A
 108
 109
 111
 112
 113
 114
 115
 116
 117
 118
 119
 120
 121
 122
 123
 124
 125
 126
 127
 128
 129
 130
 131
 132
 133
 134
 135
 136
 137
 138
 139
 140
 141
 142
 143
 144
 145
 146
 147
 148
 149
 150
 151
 152
 153
 154
 155
 156
 157
 158
 159
 160
 161
 162
 163
 164
 165
 166
 167
 168
 169
 170
 171
 172
 173
 174
 175
 176
 177
 178
 179
 180
 181
 182
 183
 184
 185
 186
 187
 188
 189
 190
 191
 192
 193
 194
 195
 196
 197
 198
 199
 200

Approved: [Signature]
 Special Agent in Charge
 Copies made:
 1 - Bureau (92-3267) (1228-2)
 1 - USA, Los Angeles
 (Attn: AUSA TIMOTHY M. THORNTON)
 2 - Chicago (92-399)
 2 - Las Vegas (92-467)
 2 - Los Angeles (92-113)

Do not write in spaces below

92-3267-146	REC-62
25 MAR 19 1962	801.

1 Cum Div Dept
 0-6-0
 3/31/62
 1 - IRS via Liaison 4/2/62

Property of FBI - This report is loaned to you by the FBI, and neither it nor its contents are to be distributed outside the agency which loaned it.

100-1541
 62 MAR 30 1962
 100-550
 9/14/75

LA 92-113

b2
b7D
b7C
On 9/1/61 [REDACTED] furnished information that a man came to ROSELLI's apartment in Las Vegas and ROSELLI introduced this person as [REDACTED] his landlord (probably [REDACTED] attorney from Los Angeles who now owns the Diplomat Apartments). According to [REDACTED], ROSELLI told [REDACTED] that if the manager of the Diplomat Apartments left anyone in ROSELLI's apartment to "bug" it he will "sue the manager and the people who bug it".

b7C
Later in the same day [REDACTED] and ROSELLI discussed the type of locks on ROSELLI's doors and ROSELLI said that he had two locks on both the back and front doors and that the maid is the only person with the keys. According to this source, ROSELLI apparently feels very secure in his apartment and ROSELLI told [REDACTED] that he did not believe anybody could get into the apartment until they drilled the locks in which event ROSELLI would know about it. [REDACTED] told ROSELLI that the locks were five pin tumbler type locks and could possibly be picked.

It may be that ROSELLI was referring to his Los Angeles apartment when he stated he has two locks on both the front and back doors. It is known that ROSELLI has two locks on the front door of his apartment in Los Angeles and that for some time the only person having a key was the maid.

b2
b7D
[REDACTED] furnished information that JOHN ROSELLI was in conference with SAM GIANCANA at Chicago, Illinois, on 12/6/61. During this conversation ROSELLI and GIANCANA discussed latest electronic devices, which discussion is set out below:

- C -
COVER PAGE

LA 92-113

b7c

ROSELLI: Oh, I gave [REDACTED] that thing to bring up to you.

GIANCANA: It's no good. It's not the kind I was looking for. I was looking for the kind for the room that would fit anyplace, a little disc, that you could lay anywhere.

ROSELLI: Oh, Electronics.

GIANCANA: Yeah. It's all right for sending. No, it's a receiver, but it's not a sender.

ROSELLI: It's a sender too. The thing that you have you can put between the door. And then you tune them in across the street.

GIANCANA: What I want is something really small....

ROSELLI: All right, here's one, you put on a wall, you.... I got a guy out there, this is what he brought me.

GIANCANA: You can't take a big mike like this and put it in a flat.

ROSELLI: Sure. You take it apart.

GIANCANA: If you take it apart, you're dead. You won't get the volume. As clear as...

ROSELLI: Well, we'll play with it. We got a guy, an electronic guy.

GIANCANA: The main thing is....

ROSELLI: There is one thing, let me tell you what it is. The CIA has it, they have a thing,...

LA 92-113

GIANCANA: Like a cigarette.

ROSELLI: Yeah, but ... the FBI out there, somebody has got a portable....it takes conversations way out. The FBI has it. Electronics,..... spy system....Washington, now, and I told them, for Christ' sake, report on that thing. I gotta have it.....CIA....

GIANCANA: If you can't get that, tell them to get the kind that you.....

ROSELLI: I got another guy in Los Angeles who's got an electronic cap kind of a thing... and he showed me that....so I gotta find out what the smallest thing is. If you put it in there, you want to take it and get a receiver? And receive it where you're set up?

GIANCANA: Maybe a block, two blocks, three blocks.

ROSELLI: No, you can't go that far.

GIANCANA: We had one downtown about a year ago, a home made one, a little box, went to the hotel room (St. Clair Hotel) and stuck it in the guy's room, went down two blocks, you know where the St. Clair Hotel is at? Went two blocks away, sat in the car, then turned it on, and got all the conversation. Two blocks away. b7c [REDACTED] had it.

ROSELLI: How big was your receiver?

GIANCANA: Like a..... that's all. Box was only this big, maybe three by three. We were talking, bla, bla, bla,.....picked it up.

GIANCANA: Think about it.

LA 92-113

ROSELLI: Yeah, I'll work on it. BOBBY is in Washington.....

GIANCANA: Well, JOHN, we'll see you tomorrow night.

ROSELLI: Wait a minute, now, you gonna be busy tomorrow?

GIANCANA: Yeah. Most of the day.

ROSELLI: Let me stay over, I'll send this guy back. Or maybe I'll keep him over an extra day.

GIANCANA: What the hell is the difference?

ROSELLI: All right, I'll meet you tomorrow night. Seven o'clock. I want to tell you all these things, so you know. I can stay a week, a month, what do I care. But I'm trying to con this guy, that I'm staying over for him. Now, what I'll do is go downtown now. Do you know how to get in touch with me? I'm in 605, [REDACTED] Ambassador West. [REDACTED] Tomorrow you'll be busy all day.

GIANCANA: Tomorrow afternoon, I'll call you and I'll come down.

ROSELLI: Come down tomorrow afternoon and I can go with him tomorrow night. See? I'll wait in the hotel. It's in the California Suite. Come down about two, three o'clock.

LA 92-113

Apparently GIANCANA is interested in obtaining a very small microphone which he can place in a room or an apartment to pick up conversations. ROSELLI mentions the CIA and apparently has some contact with CIA who is in a position to furnish ROSELLI with the latest information and/or equipment used to pick up conversations and either exhibited photographs of these devices or the actual devices themselves to GIANCANA. The situation which GIANCANA refers to in the St. Clair Hotel was one reported by [REDACTED] some time ago whereby MURRAY HUMPHREYS, [REDACTED] and apparently himself rigged up a home-made microphone and receiver, and placed it in the meeting room of the St. Clair Hotel after which they sat in their car two blocks away and were able to pick up the conversation. ROSELLI then concluded by stating that he was staying at Room 605 at the Ambassador West Hotel with [REDACTED]

b2
b7D
b7C
b7C

It is noted that in the above conversation, ROSELLI states "BOBBY is in Washington." It is suggested that this may possibly be ROBERT MAHEU, who operates a private investigative group, and who is a friend of ROSELLI. It is recalled that MAHEU and ROSELLI were involved in an investigation wherein MAHEU was working for CIA, and was to establish contact with SAM GIANCANA.

It is further recalled that during some phase of this operation, a wire tap was put in the hotel room of DAN ROWAN at the Riviera Hotel in Las Vegas, at a time when DAN ROWAN was keeping company with PHYLLIS MC GUIRE, who is also a girl friend of SAM GIANCANA. It is further suggested as a possibility that MAHEU may be the contact through which ROSELLI obtains his information concerning electronic devices. u

The individual who furnished the information from the [REDACTED]

b7C
b7D
OS

**UNITED STATES DEPARTMENT OF JUSTICE
FEDERAL BUREAU OF INVESTIGATION**

Copy to: U. S. Attorney, Los Angeles
ATTENTION: Assistant U. S. Attorney TIMOTHY M. THORNTON

Report of: [REDACTED] b7C Office: Los Angeles,
Date: 3/10/62 California

Field Office File #: 92-113 Bureau File #: 92-3267

Title: JOHN ROSELLI

ALL INFORMATION CONTAINED
HEREIN IS UNCLASSIFIED TO #22,330
DATE 3/11/81 BY SP4 Jmm/ks
CIA Info unclassified per John E. Bacon
8/27/80

Character: ANTI-RACKETEERING

Synopsis:

ROSSELLI, FBI No. 3339986, claims birth at Chicago, Illinois, on 7/4/04. FBI Laboratory examination of signatures on Report of Birth, filed in 1936, and on Affidavit of Birth, upon which Report of Birth is based, reveals signatures to be forgeries. ROSSELLI married WINIFRED JUNE VLASEK (actress JUNE LANG) in 1940, was divorced in 1943, and has not remarried. In 1950 ROSSELLI testified before Kefauver Committee and stated he engaged in buying and selling liquor in Los Angeles during prohibition era; that he was acquainted with AL CAPONE, and that he engaged in wire service for horse racing information in the late 1930's. He was convicted in Federal Court in New York City on 12/23/43 on charge of conspiracy to extort money from individuals in movie industry, sentenced to ten years imprisonment, and paroled in 1947. In 1957-1958, he was allegedly active in management of Tropicana Hotel, Las Vegas, Nevada, in an unofficial capacity. He obtained concessions from Tropicana Hotel but sold these in 1958 upon request of Nevada Gaming Control Board. He was officer in Monte Proser Productions, Inc., which produced floor shows at Tropicana Hotel, from 1957 until first part of 1959. Since 1959 has engaged in promoting and investing in various enterprises in Las Vegas area. He is currently engaged in producing motion picture of Las Vegas night life through Showcase Enterprises, Inc. He obtained contracts from all major hotels to shoot scenes in the casinos. Investigation indicates ROSSELLI may be handling various matters in Las Vegas for SAM GIANCANA, Chicago gambling figure. In December, 1961, he reported to

LA 92-113
HFD:nlb

GIANCANA concerning matters in Las Vegas. In latter part of 1961 he and GIANCANA involved in wire tap case in Las Vegas. He is in contact in Los Angeles with ~~EDITH E. CAMBER~~ who is friend of GIANCANA and who makes numerous telephone calls to GIANCANA's residence in Illinois. ROSSELLI has admitted he associates with highly controversial individuals who are friends, and said he would continue to associate with them. He allegedly stated he invests money for others in legitimate enterprises, but the money may be "illegitimate." He maintains apartments in Los Angeles and in Las Vegas and travels back and forth frequently. u

-P-

LA 92-113
HFD:nlb

Robert M. Heu

155 - South H. Bristol
15 Redwood, Calif

Information has also been set out in this report under the heading "Criminal Activities" reflecting that in the latter part of 1960, ROBERT A. MAHEU was requested by CIA to contact SAM GIANCANA regarding Cuban matters, and that MAHEU got in touch with GIANCANA through JOHN ROSSELLI; that thereafter, a wire tap was placed on the telephone of DAN ROWAN at the Riviera Hotel in Las Vegas, Nevada, allegedly at the request of MAHEU, and according to MAHEU, to discover if there had been a leak of information through PHYLLIS MC GUIRE, a girl friend of SAM GIANCANA, who was then keeping company with DAN ROWAN. MAHEU advised that he had discussed some type of an installation with ROSSELLI prior to the time it was actually made. ca

Information is also set out in this report under the heading "Contacts and Associates" and specifically under the heading "JUDITH E. CAMPBELL" reflecting that CAMPBELL, a friend of GIANCANA, has been in frequent contact with GIANCANA's residence in Chicago via telephone, and she has also been in contact with JOHN ROSSELLI. u

LA 92-113
HFD:mjg

The records of the hotel reflect that during the period September 12 to 15, 1961, Rooms 405 and 407 were charged with a number of toll calls including the following. As set out previously in this investigation, the identity of the subscribers to these numbers was furnished by [REDACTED]

<u>Telephone No.</u>	<u>Room</u>	<u>Date</u>	<u>Subscriber</u>
[REDACTED]	[REDACTED]	9/13	[REDACTED]
[REDACTED]	[REDACTED]	9/13	[REDACTED]
[REDACTED]	[REDACTED]	9/14	[REDACTED]
[REDACTED]	[REDACTED]	9/13	[REDACTED]
[REDACTED]	[REDACTED]	9/12 9/14	[REDACTED]
[REDACTED]	[REDACTED]	9/15	[REDACTED]
[REDACTED]	405	9/15	(no answer)
[REDACTED]	405 407	9/14	Four Trees Restaurant 7800 Sunset Blvd., [REDACTED]

LA 92-113
HFD:mjg

HO 1-9321

405
407

9/15
9/13 &
9/14

Zeman, Fuller Boyer &
Goldberg - CPAs,
7833 West Sunset Blvd.,
Los Angeles, Calif.

[REDACTED]

[REDACTED]

EX 5-8888

405

9/13 &
9/14

ROBERT A. MAHEU,
155 South Bristol,
Brentwood, Calif.

39 5-8888

405

9/13 &
9/14

[REDACTED]

UP 0-3775

405

9/13 &
9/14

Showcase Enterprises,
8822 Washington Blvd.,
Culver City, Calif.

b7C
b7D
OS

[REDACTED]

LA 92-113
HFD:mjg

[REDACTED]

b7C
b7D
OS

On [REDACTED] ROSSELLI was not a guest at the hotel during this period, but on December 14, 1961 [REDACTED] observed ROSSELLI arrive at the hotel in a 1961 black Lincoln Continental automobile and pick up [REDACTED]

[REDACTED] stated T. W. RICHARDSON, Riverside Hotel, Reno, Nevada, was also a guest at the hotel from December 11 to 14, 1961 and on December 11, 1961. RICHARDSON was charged with a telephone call to [REDACTED] at [REDACTED] Las Vegas, Nevada.

Information will be set out later in this report that T. W. RICHARDSON is an acquaintance of JOHN ROSSELLI and that in the latter part of 1960, an investigation was conducted concerning a wire tap on the phone of DAN ROWAN at the Riviera Hotel in Las Vegas in which an individual

LA 92-113
HFD:mjg

named ARTHUR JAMES BALLETTI was arrested by local authorities and in which JOHN ROSSELLI was involved. BALLETTI revealed that he was told by ROBERT MAHEU, a private detective and a friend of ROSSELLI, that he, BALLETTI, was to contact a Mr. T. W. RICHARDSON at the New Frontier Hotel in Las Vegas and RICHARDSON would pay him \$1000. BALLETTI contacted RICHARDSON and received the \$1000. RICHARDSON, upon interview by Bureau Agents, denied this.

[REDACTED]

[REDACTED]

[REDACTED]

[REDACTED]

[REDACTED]

[REDACTED]

[REDACTED]

[REDACTED]

[REDACTED]

[REDACTED]

b7C
b7D
OS

HFD: tzg
LA 92-113

T. W. RICHARDSON
Las Vegas Nevada

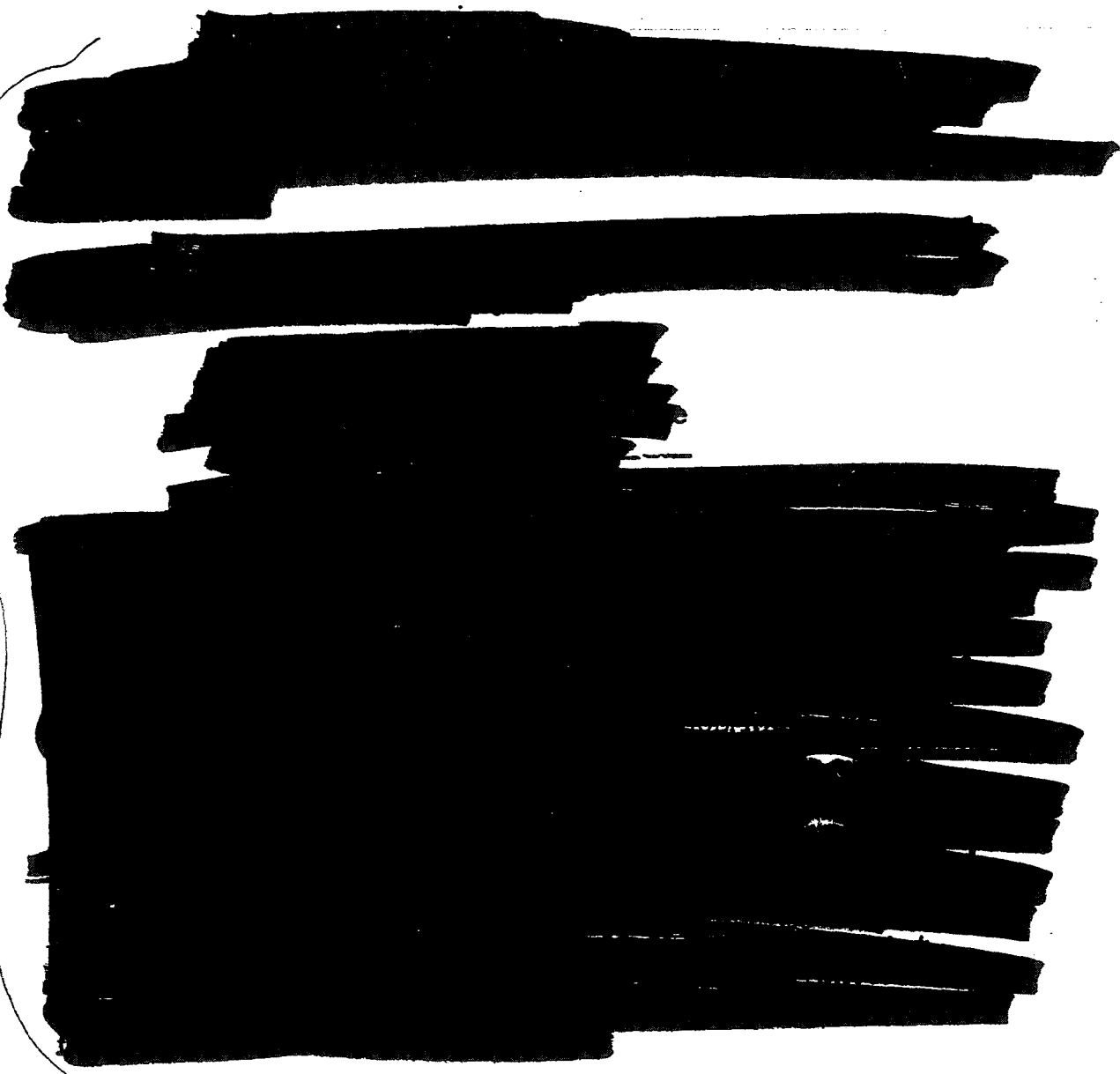

b2
b7C
b7D
OS

HFD: tgz
LA 92-113

[REDACTED]

b7C
b7D
OS

[REDACTED]

Information is also set out above concerning T. W. RICHARDSON, who allegedly paid ARTHUR JAMES BALLETTI \$1,000 in connection with the placing of a wire tap on the telephone of DAN ROWAN at the Riviera Hotel in Las Vegas.

[REDACTED]

b7C
b7D
OS

LA 92-113
HFD:djv

OS { in Chicago. Through these connections, he controlled the Race Wire Services in Los Angeles, and subsequently, he was employed at Columbia Studios. He said that he recalls that the late HARRY COHN, President, Columbia Studios, called ROSSELLI and told him that the workers at Columbia were going to strike the following day. He said that ROSSELLI got up in the middle of the night and contacted WILLIE BIOFF and told BIOFF that he was not going to strike Columbia Pictures. He said that on the basis of this, ROSSELLI was convicted with BIOFF, BROWNE, et al, in the well-known motion picture extortion case. He insisted that he did not believe that ROSSELLI was personally involved in receiving pay-offs from the motion picture industry, but that his conviction was based on the fact that he had ordered that there would be no strike at Columbia Pictures. On the basis of this, it would appear that he had "pull" over the others involved in this shakedown. ✓

POSSIBLE INVOLVEMENT IN WIRE TAPPING
AT RIVIERA HOTEL, LAS VEGAS, NEVADA

On October 31, 1960, ARTHUR JAMES BALLETTI was arrested at the Riviera Hotel in Las Vegas, Nevada, at which time he admitted that he had received instructions from Investigations, Inc., Miami, Florida, to surveil and record telephone conversations of DAN ROWAN, who was then staying at the Riviera Hotel. BALLETTI stated that he had received instructions from ROBERT MAHEU to contact T. W. RICHARDSON at the New Frontier Hotel and RICHARDSON would pay him \$1,000 for the work which was being done by BALLETTI. Investigation revealed that an unknown individual using the name J. W. HARRISON, participated in the placing of the telephone surveillance in DAN ROWAN'S room. ✓

T. W. RICHARDSON, who is part owner of the New Frontier Hotel, upon interview denied knowing BALLETTI or paying any money to BALLETTI or anyone else in connection with this matter. ✓

It is noted that at this time ROWAN was keeping company with PHYLLIS MC GUIRE of the MC GUIRE Sisters singing act and ROWAN later advised that he intended to marry PHYLLIS MC GUIRE.

LA 92-113
HFD:djv

PHYLLIS MC GUIRE had reportedly been the girl friend of SAMUEL GIANCANA of Chicago. Information received during July, 1960, from an informant in Las Vegas, indicates that GIANCANA is again keeping company with PHYLLIS MC GUIRE. u

EDWARD L. DUBOIS of Investigations, Inc. advised that in October, 1960, he received a telephone call from ROBERT MAHEU, a private investigator, Washington, D.C., requesting that DUBOIS send two men to Las Vegas on October 26, 1960, for physical surveillance work. Subsequently, according to DUBOIS, MAHEU told him only to send one man as he, MAHEU, was going to send one man. Thereafter, DUBOIS sent BALLETTI and the unknown individual who used the name J. W. HARRISON accompanied BALLETTI. u

During the period from October 11 to October 29, 1960, ROBERT A. MAHEU and a J. A. ROLLINS were registered at the Kenilworth Hotel, Miami Beach, Florida, and ROLLINS accompanied MAHEU. MAHEU informed SAs of the FBI that J. A. ROLLINS was JOHN A. ROLLINS but refused to further identify him. u

67C { Investigation disclosed that while at the Kenilworth Hotel, ROLLINS was charged with two telephone calls to telephone number [redacted] in Chicago, Illinois, which is the telephone number of [redacted] who has been identified in the ROSSELLI investigation as a close friend and associate of ROSSELLI. ROLLINS was also charged with a telephone call to telephone number [redacted] Woodland Hills, California, which is the number of [redacted] who has also been identified as a close friend and associate of ROSSELLI. u

ROLLINS was also charged with a telephone call to telephone number DU 2-6000 which is the telephone number of the Desert Inn Hotel, Las Vegas, Nevada, where ROSSELLI had received many telephone calls in the past. u

JAMES FOLEY, an attorney in Las Vegas, Nevada, advised that in the latter part of October, 1960, he received a telephone call from JAMES P. CANTILLON of the law firm of Cantillon and Cantillon, Beverly Hills, California, requesting that FOLEY represent BALLETTI and arrange for his bond. CANTILLON personally guaranteed FOLEY's fee. It is noted

LA 92-113
HFD:djv

that JAMES P. CANTILLON is JOHN ROSSELLI's attorney and a close associate of ROSSELLI's. u

Upon interview by SAs of the FBI, JAMES P. CANTILLON said that he first heard of the microphone incident when he received a call from a man in custody in Las Vegas whose name he did not recall. He said that the name BALLETTI was probably correct. He advised that he referred this man to THOMAS FOLEY an attorney in Las Vegas. u

Further investigation revealed that Central Intelligence Agency (CIA) in connection with their operations concerning FIDEL CASTRO in Cuba contacted ROBERT MAHEU to act as "cutout" in contacts with SAM GIANCANA on the theory that GIANCANA through his gambling activities in Cuba under the Batista Government might still have sources and contacts in Cuba who could be of value to CIA. According to officials of CIA, this organization did not authorize the microphone surveillance on DON ROWAN.

On May 25, 1961, MAHEU advised SAs of the FBI that the original contact with GIANCANA after MAHEU had been requested by CIA to make contact with GIANCANA was made by "JOHNNY" who he declined to further identify.

On June 29, 1961, MAHEU advised SAs [redacted] and [redacted] that he would verify "JOHNNY's" identity if the Agents named the man. When JOHN ROSSELLI's name was furnished to MAHEU he admitted that ROSSELLI was the "JOHNNY" he referred to and that ROSSELLI was also identical to J. A. ROLLINS who registered with him at the Kenilworth Hotel in Miami Beach, Florida, in October, 1960. u

ROBERT MAHEU was interviewed at 190 North Canon Drive, Beverly Hills, California, on July 13, 1961. MAHEU was informed of his right to an attorney and that he did not have to answer questions and that anything he did say could be used against him in a court of law. u

MAHEU stated that in connection with the confidential assignment for CIA he had been in contact with SAMUEL GIANCANA and had received valuable assistance from GIANCANA, which, in turn, was furnished to CIA. MAHEU had reason to believe that

LA 92-113
HFD:djv

GIANCANA may have disclosed information regarding the project and, in view of the sensitive nature of the project, he, MAHEU, decided to determine whether or not GIANCANA had actually talked to unauthorized persons. He was aware that GIANCANA was very close in a romantic way with PHYLLIS MC GUIRE of the Mc Guire Sisters Trio. He said that if GIANCANA had disclosed this information regarding project to anyone, he would have disclosed it to PHYLLIS MC GUIRE. He said that he was also aware that in the fall of 1960 the relations between PHYLLIS MC GUIRE and GIANCANA were strained and that PHYLLIS was romantically involved with DAN ROWAN, who was appearing at the Riviera Hotel in Las Vegas. He considered it very vital to determine whether or not GIANCANA was reliable and decided to order an installation on DAN ROWAN's room in an effort to determine whether or not GIANCANA had disclosed any information regarding the project to PHYLLIS MC GUIRE.

MAHEU stated that this decision was his own and that GIANCANA had no knowledge that the installation was made. He said that he did discuss this with JOHN ROSSELLI, since he felt obligated to discuss it with ROSSELLI, as ROSSELLI had been instrumental in putting him in contact with GIANCANA. MAHEU denied that the installation was made at the request of ROSSELLI or GIANCANA or for the benefit of either ROSSELLI or GIANCANA. He said that he did discuss his decision with ROSSELLI some time prior to ordering the installation but does not recall the specific date or place where he discussed the matter with ROSSELLI. He pointed out that he does not recall whether or not this occurred during October, 1960, when they were both registered at the Kenilworth Hotel in Miami Beach, Florida. He pointed out that he had met with ROSSELLI on a number of occasions and, therefore, does not recall the specific occasion in which he discussed his decision with ROSSELLI. He does not recall what comment ROSSELLI made when informed of his decision. U

MAHEU said that he requested EDWARD L. DUBOIS, Jr., a Miami Beach private investigator, to institute a technical surveillance of DAN ROWAN's room at the Riviera Hotel in Las Vegas, Nevada. He said that he does not recall what his specific requests were regarding the

LA 92-113
HFD:djv

type of installation to be used, but had left this up to DUBOIS. He said that he was interested only in conversation within DAN ROWAN's room and had in mind the installation of a microphone and transmitter and not a telephone tap. He said, however, that he does not recall whether or not he specified not to make a telephone installation. He said that he does recall that he definitely did not request a physical surveillance of ROWAN. u

MAHEU stated that he does not know the identity of the unknown subject, also known as J. W. HARRISON. He said that he definitely did not contact DUBOIS and tell DUBOIS that he would send one of his men. He insisted that DUBOIS furnished both men to handle this assignment in Las Vegas and that DUBOIS had charged him for transportation and time for two men. u

MAHEU repeated that he would take full responsibility for ordering the installation, that the installation was made for the reasons he had given above and in a previous interview, and definitely was not made at the request or for the benefit of JOHN ROSSELLI or SAMUEL GIANCANA. u

JOHN ROSSELLI was contacted at Drucker's Hair-dressers for Men, 9740 Wilshire Boulevard, Beverly Hills, California. ROSSELLI was informed of his right to have an attorney and that he did not have to say anything and that anything he did say could be used against him in a court of law. u

ROSSELLI admitted that he has known ROBERT MAHEU for approximately five years. When asked if he knew SAM GIANCANA, ROSSELLI stated, "Let's discuss the weather. I do not care to answer any more questions." ROSSELLI stated that he knew of nothing illegal that MAHEU had done, but for any additional information regarding his association with MAHEU, the Agents should talk with MAHEU himself. u

b7c ROSSELLI was telephonically contacted by SA [REDACTED] at his Los Angeles apartment, 1251 Crescent Heights Boulevard, Los Angeles, on July 19, 1961, in an effort to

LA 92-113
HFD:djv

arrange an interview. ROSSELLI advised that he did not care to discuss his association with MAHEU at any time with the FBI. u

[REDACTED]

POSSIBLE EXTORTION IN CONNECTION
WITH SHOW "FLOWER DRUM SONG"
THUNDERBIRD HOTEL, LAS VEGAS, NEVADA

[REDACTED] u

[REDACTED] u

b2
b7C
b7D

OS

LA 92-113
HFD:nlb

TRAVEL

Information received during 1958, 1959, 1960 and 1961 from various travel agencies in Los Angeles and Beverly Hills, California, from the Los Angeles Police Department, and from informants and sources of information in the Los Angeles and Las Vegas Offices, has shown that ROSSELLI usually travels back and forth between Las Vegas and Los Angeles, California, two, three or more times each month. As set out above, he maintains an apartment in Las Vegas and an apartment in Los Angeles, and when he travels between these two cities, he seldom carries luggage with him.

Information is set out above in this report regarding the wire tap at the Riviera Hotel in the fall of 1960; that from the period October 11 to October 29, 1960, ROBERT A. MAHEU and ROSSELLI, who was using the name J. A. ROLLINS, were registered at the Kenilworth Hotel, Miami Beach, Florida. MAHEU admitted that the person registering as J. A. ROLLINS was ROSSELLI.

In [REDACTED] furnished information that ROSSELLI was in Chicago for one, two or three days during the first part of December, 1961.

[REDACTED] that he had received information that ROSSELLI was then in Chicago, Illinois.

[REDACTED] advised that he had received information that ROSSELLI was still in Chicago, Illinois, as of February 10, 1961.

[REDACTED] furnished information to Agents of the Miami Office that JOHN ROSSELLI was observed by him at the Fountainbleu Hotel in Miami in the company of a good-looking girl.

LA 92-113
HFD/seb

PAGES

[REDACTED]

158
28, 29, 30, 31,
32, 33, 37, 68,
117, 172, 173,
174, 211

[REDACTED]

14, 28, 33, 34, 36,
38, 39, 40, 51, 66,
142, 154, 155, 158,
159, 171, 204, 227

[REDACTED]

34
9, 10

[REDACTED]

9
53
92, 93, 104
93, 104

[REDACTED]

88
88

[REDACTED]

154
31

[REDACTED]

31
149

[REDACTED]

43, 146
91, 98, 104
94, 99

[REDACTED]

99
106A, 107

[REDACTED]

108
231

MAHEU, ROBERT

47, 122
164

MAHEU, ROBERT A.

167
53, 141, 142, 143
27, 48

[REDACTED]

77
48, 124
126
124
125

47C
OS

7/1/63
2/1/63
10

FBI

Date: January 31, 1963

Transmit the following in PLAIN TEXT
(Type in plain text or code)
Via AIRTEL AIR MAIL - REGISTERED
(Priority or Method of Mailing)

TO : DIRECTOR, FBI (92-3267)
FROM : SAC, LOS ANGELES (92-113-E) (P)
RE : JOHN ROSELLI, aka.
AR

REC-67 2

b2
b7D

The following is a summary of information received from [redacted] during the period from 1/15/63 to 1/30/63. u

On 1/15/63, ROSSELLI was at his apartment during the morning and engaged in a telephone conversation with an unknown person, but the subject matter of the conversation was not detailed enough to be intelligible. u

No information of pertinence was received on 1/16/63. ROSSELLI went to Las Vegas, Nevada, on 1/16/63, and did not return to Los Angeles until 1/21/63. Source furnished no information of value on 1/21/63. u

On 1/22/63, ROSSELLI had a long telephone conversation with a girl named [redacted] (probably [redacted]). The conversation for the most part dealt with ROSSELLI's accusations about [redacted] mercenary relationship with several men, including [redacted]. u

b7C
OS

ROSSELLI talked to an unknown person and remarked that they had a table for eight. He mentioned [redacted] in connection with this matter. (This probably refers to the dinner being held on the evening of 1/22/63, at the Friar's Club in Beverly Hills, to honor SAMMY DAVIS, JR.) u

EX-102

REC-67

4 2 2

- 3 - Bureau (92-3267) (Air Mail - Registered)
 - 1 - Los Angeles (92-113-E)
- HFD:HMS
(4)

13 FEB 1963

FEB 8 1963

[Handwritten signatures and initials]

Approved: [Signature] Special Agent in Charge Sent _____ M Per _____

ROSSELLI told the unknown person that he just returned to town the day before and that he was going back the next day. In this conversation, ROSSELLI mentioned buildings and property and the fact that he had tried to buy some land. He said he could have bought it for 385 and they paid 550 for it, and they could probably get about a million or a million and two for it now. u

On 1/22/63, ROSSELLI made two calls trying to get in touch with ROBERT MAHEU and left a message as to where MAHEU could reach him. u ~~MAHEU~~ no/oc,

On the same date, ROSSELLI called [REDACTED] and told her he was going away for a few days, and mentioned that "they are having a dinner tomorrow for [REDACTED] He wanted [REDACTED] to fly to Las Vegas with him, and indicated that [REDACTED] said he would be happy to get [REDACTED] started with his bank up there. u

ROSSELLI told [REDACTED] on 1/22/63, that [REDACTED] had a ticket for [REDACTED] or the SAMMY DAVIS dinner. u

On 1/23/63, ROSSELLI talked to an unknown person and told this person to get hold of LEO. He then mentioned that he was bringing [REDACTED] to Las Vegas and said, "Be sure to say nothing to him, I think he knows something." (This may refer to [REDACTED]. u

ROSSELLI left Los Angeles for Las Vegas on the afternoon of 1/23/63, with [REDACTED] and a man named [REDACTED].

As of 1/30/63, no information had been received that ROSSELLI had returned to Los Angeles. u

FBI

Date: 3/23/63

Transmit the following in _____
(Type in plain text or code)

Via AIRTEL AIR MAIL
(Priority or Method of Mailing)

TO: DIRECTOR, FBI (92-3267)
FROM: SAC, LOS ANGELES (92-113C)
RE: JOHN ROSELLI, aka
AR

b2
b7D

ROSSELLI returned to his Los Angeles apartment on evening of 3/20/63. According to [redacted] on the evening he returned, he talked to an unknown person and made an appointment to see the person about 12 o'clock. FISUR conducted on 3/21/63 revealed ROSSELLI did not leave his apartment until after one P.M. and then went directly to the Friar's Club in Beverly Hills, California.

b2
b7D

[redacted] advised that the morning of 3/21/63 ROSSELLI called to talk to ROBERT MAHEU but MAHEU was not in and ROSSELLI left a message that he could be reached at the Friar's Club. MAHEU is a well known private investigator and former FBI Agent who is a friend of ROSSELLI and a person with whom ROSSELLI has had business dealings in the past.

b2
b7D

[redacted] advised that ROSSELLI was observed by informant at the Friar's Club shortly after 3:00 P.M. on 3/21/63. ROSSELLI was with [redacted] and [redacted] part owners of the New Frontier Hotel in Las Vegas, Nevada. [redacted]

b7C
b7D

3 - Bureau (RM)
1 - Los Angeles

HFD /AY
(4)

REC-70

92-113C-443

MAR 25 1963

EX-102

McC. Wick

Approved: W G SIBB Special Agent in Charge

Sent _____ M Per _____

56 MAR 28 1963

LA 92-113C

b7D

b7C

b2

b7C

b7D

[REDACTED] advised that on the morning of 3/22/63, ROSSELLI called [REDACTED] and made an appointment to meet [REDACTED] that day at the Friar's Club.

b7C

b7C

FISUR on 3/22/63 revealed ROSSELLI left his apartment about 10:30 A.M. and visited his tailor, MANNY DWARK and then went to Beverly Hills, California. He arrived at the Friar's Club shortly after 1:00 P.M. [REDACTED] automobile was observed parked on the street immediately in front of the Friar's Club. As of about 3:30 P.M. both ROSSELLI's and [REDACTED] cars were still parked at the club.

REC-45 13, 23
35, 42

FEDERAL BUREAU OF INVESTIGATION

REPORTING OFFICE LOS ANGELES	OFFICE OF ORIGIN LOS ANGELES	DATE 3/25/63	INVESTIGATIVE PERIOD 2/20 - 3/21/63
TITLE OF CASE JOHN ROSELLI, aka		REPORT MADE BY [REDACTED]	TYPES b7C DHA
		CHARACTER OF CASE AR	

REFERENCES:

- Report of SA [REDACTED] Los Angeles, 2/25/63. *b7C*
- Las Vegas teletypes to Los Angeles, 2/23, 27, 3/1/63.
- Los Angeles teletypes to Las Vegas, 2/23 and 3/9/63.
- New York letter to Los Angeles, 2/19/63.
- Chicago airtel to Los Angeles, 2/22/63.
- Los Angeles letter to Chicago, 2/25/63.
- Los Angeles letter to Newark, 2/25/63.
- Los Angeles letter to Las Vegas, 2/25/63.

11 APR 1 1963

APPROVED *[Signature]* SPECIAL AGENT IN CHARGE

COPIES MADE:

- 4- Bureau (92-3267) (~~ENCLOSURE~~)
- 1- USA, Los Angeles (Attention: AUSA Timothy M. Thornton)
- 2- Las Vegas (92-467)
- 2- Los Angeles (92-113)

DO NOT WRITE IN SPACES BELOW

92-3267-446 REC-45

APR 1 1963

COPIES DESTROYED MAY 25 1972

Notations

STAT. SECT.

Dissemination Record of Attached Report

Agency	Request Recd.	Date Fwd.	How Fwd.	By
1 Cum. Div Dept	06-2	4/2/63		

56 APR 9 1963

LA 92-113
HFD:DHA

b7C It is noted that ROSSELLI was in Las Vegas on the evening of March 13, 1963 inasmuch as will be set out later in this report. [REDACTED] was in long-distance telephonic communication with ROSSELLI in Las Vegas at this time. U

On [REDACTED] furnished information that ROSSELLI returned to his apartment late in the evening on March 15, 1963. U

On [REDACTED] stated that ROSSELLI had an appointment to meet an unknown individual at about 12:00 p.m. on that date. U

b2
b7D On the basis of information furnished by [REDACTED] and observation by Special Agents of the FBI, ROSSELLI was not at his apartment nor was his car in the apartment garage from March 16, 1963 until the evening of March 20, 1963, when ROSSELLI returned. U

On March 21, 1963, Special Agents of the FBI observed ROSSELLI leave his apartment alone shortly after 1:00 p.m. and proceed in his 1963 Ford Thunderbird to the Friars Club in Beverly Hills, California. U

On [REDACTED] furnished information that ROSSELLI wanted to get in contact with ROBERT MAHEU. MAHEU has been previously identified in this investigation as being a private investigator and a friend of ROSSELLI. U

LA 92-113
HFD:jcc

INDEX

<u>Name</u>	<u>Page</u>
[REDACTED]	51
[REDACTED]	6
B & R ENTERPRISES	48
BEVERLY CREST HOTEL	11, 12,
	17, 18
BEVERLY HILTON HOTEL	15
[REDACTED]	43
[REDACTED]	32, 33
[REDACTED]	12, 27,
[REDACTED]	28, 29,
[REDACTED]	32, 48,
[REDACTED]	49
[REDACTED]	35, 36,
[REDACTED]	37, 38,
[REDACTED]	40, 41
[REDACTED]	41
[REDACTED]	10
[REDACTED]	33
CAPONE, AL	27
CHATHAM LIMOUSINE SERVICE	35
[REDACTED]	48
[REDACTED]	26
[REDACTED]	23
DESERT INN HOTEL	11, 12, 13
END OF THE SANTA FE TRAIL	27, 31
[REDACTED]	24
FRASCATI'S RESTAURANT	12
[REDACTED]	11, 12,
[REDACTED]	15, 17,
[REDACTED]	18, 23,
[REDACTED]	24
[REDACTED]	17
[REDACTED]	5, 6, 7

b7C
OS

LA 92-113
HFD:jcc

Name

Page

GIANCANA, SAMUEL

37, 41
13
21

[REDACTED]

[REDACTED]

17
39
21
21
15

[REDACTED]

43

[REDACTED]

42, 43,
44, 45

KARL'S SHOE STORE

17
27
27
51
30
8

[REDACTED]

[REDACTED]

36
17

LOAU, THE

MAHEW, ROBERT
MARINA, INC.

14
48

[REDACTED]

46, 47
37, 42
21, 22,
23, 24

[REDACTED]

"MAN UPSTAIRS, THE"
MARQUIS RESTAURANT

21
28-29
12
24
28-29
45

[REDACTED]

NEVADA CONCESSIONS, INC.

34
26

[REDACTED]

b7
OS

F B I

Date: 4/15/63

Transmit the following in _____
(Type in plain text or code)

Via AIRTEL AIR MAIL - REGISTERED
(Priority or Method of Mailing)

TO: DIRECTOR, FBI (92-3267)
FROM: SAC, LOS ANGELES (92-113E) (P)
RE: JOHN ROSELLI, aka
AR

b2
b7D

The following is a summary of information received from [redacted] during the period 3/18/63 to 4/12/63. U

ROSSELLI was not in Los Angeles from 3/18/63 to 3/20/63. U

On 3/21/63 ROSSELLI left a message for ROBERT MAHEN (Private investigator and former FBI Agent) to call him at the Friar's Club about 1:30 p.m. U

On 2/22 and 23/63 ROSSELLI advised unknown persons that he would be at the Friar's Club on both these dates. U

On 2/24/63 ROSSELLI was complaining to an unknown individual that the intensified investigation being conducted regarding his income was "murder". U

On 3/25/63 ROSSELLI conversed with an unknown woman who had apparently been in an automobile accident and had been in a hospital. U

b7C
b7D

On 3/27/63 ROSSELLI told [redacted] (a close friend) that he had to go see his tax man that day to see if his tax man can straighten out ROSSELLI's 1962 taxes. ROSSELLI told [redacted] he was going to drive up there (Las Vegas, Nevada) and asked [redacted] to go along so that [redacted] could see some individual there. U

3 - Bureau
1 - Los Angeles
HFD:deb
(4)

REC-23

452

EX-102

10 APR 17 1963

Approved: _____
Special Agent in Charge

Sent _____ M _____

50 APR 22 1963

FBI

Date: 5/8/63

Transmit the following in _____
(Type in plain text or code)

Via AIRTEL _____
(Priority or Method of Mailing)

TO: DIRECTOR, FBI (92-3267)
FROM: SAC, LOS ANGELES (92-113C)
RE: JOHN ROSELLI, aka.
AR

On 5/1/63 Las Vegas Office advised ROSSELLI residing Room 25, Desert Inn Hotel, Las Vegas. U

[redacted] advised that on 4/30/63 ROSSELLI received telephone call from a Mr. MAHEU. ROSSELLI was not in and a message was left for him to call MAHEU, city not stated but probably in Los Angeles. MAHEU is probably ROBERT MAHEU, Private Investigator and former Bureau Agent with whom ROSSELLI has been in contact on numerous occasions in the past. U

ROSSELLI probably returned to Los Angeles evening of 5/1/63. [redacted]

[redacted] advised that he was a passenger on Western Airlines Flight #24 for Las Vegas, which left Los Angeles at 10:30 AM on 5/2/63. U

Las Vegas Office advised on 5/7/63 that ROSSELLI still in Las Vegas. U

[redacted] advised that on 5/2/63 [redacted] and [redacted] both friends of ROSSELLI, left Los Angeles on that date on Western Airlines Flight 601, en route to Mexico City, and Acapulco, Mexico. [redacted] advised that [redacted] and [redacted] accompanied [redacted] and [redacted].

- 3 - Bureau (AM)
- 1 - Los Angeles
- HFD:srb
- (4)

REC-15

92-3267-461

MAY 10 1963

EX-108

C. C. Wick

53 MAY 20 1963

Approved: [Signature]
Special Agent in Charge

Sent _____ M Per _____

PPRS. REC. UN

b2
b7D
OS

7

5/29/63

Airtel

lab

To: SAC, Los Angeles (92-113)

From: Director, FBI (92-3267)

JOHN ROSELLI
ANTI-RACKETEERING

40

Re your FD-143 dated 5/21/63.

A review of information furnished by [redacted] reveals that John Roselli left a message for Robert Maheu to contact him at the Friars Club.

*b2
b7D*

In an effort to determine if Maheu has any contacts with hoodlum interests, you should discreetly obtain and review a record of all telephone toll calls made by Maheu for the past three months. Advise Bureau results of your inquiry.

Ja

MAILED 8
MAY 29 1963
COMM-FBI

EX-120

JEK:amr

-8-

amr

REC-89

92-3267-469

8 JUN 4 1963

NOTE: See cover memo Evans to Belmont, same caption, dated 5/29/63. JEK:amr

- Isco
- Mont
- hr
- aper
- illahan
- rad
- Loach
- ans
- nie
- ten
- llivan
- vel
- atter
- ie. Room
- imes
- ndy

53 JUN 6 1963

red

MAIL ROOM TELETYPE UNIT

3

80

CS

UNITED STATES GOVERNMENT

Memorandum

Tolson	_____
Belmont	_____
Mohr	_____
Casper	_____
Callahan	_____
Conrad	_____
DeLoach	✓
Evans	_____
Gale	_____
Rosen	✓
Sullivan	_____
Tavel	_____
Trotter	_____
Tele. Room	_____
Holmes	_____
Gandy	_____

TO : MR. BELMONT

DATE: May 29, 1963

FROM : C. A. EVANS *CE*

SUBJECT: JOHN ROSELLI
ANTI-RACKETEERING

9-1
Slipped in

b2
b7D

In reviewing a summary of information received during the past ninety days from [redacted] a highly confidential source, it was noted that John Roselli had attempted to contact Robert Maheu and had requested that Maheu call him at the Friars Club in Los Angeles. *u*

Maheu is apparently identical with the former Bureau Agent, currently a private investigator, who has been connected with CIA and Sam Giancana, the Chicago underworld leader. *u*

Roselli, the subject of intensified investigation, divides his time between Los Angeles and Las Vegas. He is also known to be allied with Chicago underworld interests. The reason for Roselli's attempt to contact Maheu is not known. *u*

ACTION:

If approved, the attached communication will be directed to the Los Angeles Office instructing discreet inquiry to obtain and review toll calls made by Maheu during the past three months to determine if he is in contact with hoodlum interests. *u*

Enclosure ~~_____~~

1 - Administrative Division

ALL INFORMATION CONTAINED
HEREIN IS UNCLASSIFIED

DATE 3/3/81 BY SP4-jrm/koa

EX-108

REC-21

10 JUN 5 1963

3267
4710
OS
53

CIA info unclass per let of John E. Bacon 8/27/80

JEK:amr
-6-

62 JUN 11 1963

PERS. REC. UNIT

FBI

Date: 6/21/63

Transmit the following in _____
(Type in plain text or code)

Via AIRTEL _____
(Priority or Method of Mailing)

TO: DIRECTOR, FBI
SAC, LOS ANGELES (92-113)
FROM: SAC, RICHMOND (92-New) -P-
JOHN ROPELLI, aka;
ANTI-RACKETEERING
(OO: LA)

fd-217

The Los Angeles Division, during the late afternoon of 6/20/63, telephonically requested the Richmond Division to conduct a physical surveillance of subject, who was then en route to the Dulles International Airport, via Transworld Airlines, Flight 60, due to arrive at 8:15 pm. The flight originated in Los Angeles, Calif.

Physical surveillance at the Dulles International Airport revealed that subject arrived at 8:28 pm. He was met by a man and woman driving a 1953 Ford Fairlane Ranch Wagon, bearing Maryland license DF 78-69, registered to WILLIAM KING HARVEY of 28 W. Irving St., Chevy Chase 15, Montgomery Co., Maryland. The subject, with unknown man and woman, departed in above station wagon from Dulles International Airport at 8:35 pm and proceeded to WDC, where the automobile was parked in the 1700 block of Wisconsin Ave., N.W. The subject and his two companions were then observed as they entered Tino's Continental Restaurant at 9:13 pm. Richmond Agents continued the surveillance in this area until 10:50 pm, at which time the surveillance was turned over to Agents of the WFO Office.

14

- 3 - Bureau (Regular Mail)
 - 2 - Los Angeles (AM)
 - 2 - Richmond
- HER:cbc
(7)

REC-18

92-3-1-48

JUN 22 1963

JUN 27 1963

Approved: EEB/N
Special Agent in Charge

Sent _____ M Per _____

SAC, Los Angeles (92-113)

6/25/63

Director, FBI (92-3267)

JOHN ROSELLI, aka
AR

Re Washington Field tel 6/21/63.

The Bureau has determined from CIA that Roselli, during his recent trip to Washington, D. C., was in contact with a representative of that agency. CIA has advised that Roselli has periodically indicated that he was in a position to be of assistance regarding Cuban matters. It was also reported that this last meeting between Roselli and a representative of CIA was to close out this entire matter. CIA reports that Roselli has not been given any financial remuneration by that agency and CIA has never made any commitments to him.

This is for your confidential information and should not be set forth in investigative reports.

NOTE: Brennan to Sullivan memo 6/21/63 sets forth information obtained from CIA.

ALL INFORMATION CONTAINED
HEREIN IS UNCLASSIFIED 70IPAR 22,330
DATE 3/3/81 BY SP4 JRM/KEW

CIA info unclass per let of
John E. Bacon 8/27/80

JEK: asg
(4)

REC-73

92-3267-482

19 JUN 26 1963

EX-120

MAILED 6
JUN 25 1963
CCRM-FBI

- Tolson _____
- Belmont _____
- Mohr _____
- Casper _____
- Callahan _____
- Conrad _____
- DeLoach _____
- Evans _____
- Malone _____

JUL 1 1963

MAIL ROOM TELETYPE UNIT

UNITED STATES GOVERNMENT

Memorandum

Tolson	_____
Belmont	_____
Mohr	_____
Casper	_____
Callahan	_____
Conrad	_____
DeLoach	_____
Evans	_____
Malone	_____
Rosen	_____
Sullivan	_____
Tavel	_____
Trotter	_____
Tele. Room	_____
Holmes	_____
Gandy	_____

TO *y* : MR. BELMONT *all*

FROM : C. A. EVANS *✓*

SUBJECT: JOHN ROSELLI
ANTI-RACKETEERING

DATE: June 21, 1963

With reference to my previous memorandum indicating John Roselli had met with William K. Harvey of CIA last evening, Mr. Papich of the Liaison Section advised that Roselli is returning to Los Angeles this afternoon. This information was furnished to him by Harvey.

ACTION:

The Washington Field Office has been alerted, will cover Roselli's departure for the West Coast and will appropriately advise the Los Angeles Office which covers the activities of Roselli in California. *u*

- 1 - Mr. Sullivan
- 1 - Mr. Papich

CHS:dlb
-7- *h*

AK *CHS* *Evans* *Ch*

ALL INFORMATION CONTAINED *EX-116*
HEREIN IS UNCLASSIFIED *FOIA # 22,330*
DATE 3/3/81 BY *SP4-jm/kcc*
CIA info unclass per Let of John E. Bacon 8/27/80

REC-74 92-3267484

12 JUN 25 1963

[Handwritten signature]

56 JUN 28 1963

UNITED STATES GOVERNMENT

Memorandum

Viper

Tolson	_____
Belmont	_____
Mohr	_____
Casper	_____
Callahan	_____
Conrad	_____
DeLoach	_____
Evans	_____
Gale	_____
Rosen	_____
Sullivan	_____
Tavel	_____
Trotter	_____
Tele. Room	_____
Holmes	_____
Gandy	_____

TO : W. C. SULLIVAN

DATE: June 21, 1963

FROM : D. J. BRENNAN

~~ALL INFORMATION CONTAINED
HEREIN IS UNCLASSIFIED~~

SUBJECT: JOHN ROSELLI
ANTIRACKETEERING

DATE _____ BY _____
9-1
XCIA Info Classified per let of JOHN E. BACON 8/27/80

On June 20, 1963, the following information was furnished to the Liaison Agent by William Harvey, Central Intelligence Agency (CIA), concerning Harvey's meeting with the subject on the same date:

Harvey made reference to a sensitive CIA operation which was initiated in early 1961 against Castro. This particular operation involved the possible use of individuals who had contacts in Cuba through gambling figures. As a result of its planning, CIA established contact with Roselli who allegedly was in the position to be of assistance. According to Harvey the operation, for all intents and purposes, was discontinued and canceled after the Cuban invasion fiasco in April, 1961.

Harvey advised that after the invasion and the eventual reorganization in CIA, he became the head of the division handling Cuban matters. He learned that the operation involving Roselli had not been completely cut off because Roselli periodically indicated that he was in a position to be of assistance. Harvey stated that since this matter was very closely held within CIA, it became his responsibility to control any dealings with Roselli. He, therefore, held the meeting with the subject on June 20, 1963, for the purpose of closing-out the entire matter since he, Harvey, is leaving [redacted]. He stated that CIA has not given Roselli any financial remuneration and has never made any commitments to him.

He advised that if the Bureau needed any further details he would be glad to cooperate in every way possible.

ACTION:

For information.

*WE HAVE LEARNED
ROSELLI IS RETURNING
TO LOS ANGELES
TODAY.*

- 1 - Mr. Belmont
- 1 - Mr. Evans
- 1 - Mr. Sullivan
- 1 - Mr. McAndrews
- 1 - Liaison
- 1 - Mr. Papich

SJP:gp (27) 1963

EX-116

10 JUN 26 1963

~~CONFIDENTIAL~~

CLASS. & EXT. BY SP4-Jum/ka 3/5/81
 REASON-FCIM II, 1-2.4.2
 DATE OF REVIEW 6/21/83
 ALL INFORMATION CONTAINED
 HEREIN IS UNCLASSIFIED
 EXCEPT WHERE SHOWN
 OTHERWISE

*(b)(1)(43)
per CIA*

UNITED STATES GOVERNMENT

Memorandum

TO : Mr. Belmont

DATE: 6-21-63

FROM : C. A. Evans

SUBJECT: JOHN ROSELLI
ANTI-RACKETEERING

Tolson	✓
Belmont	✓
Mohr	✓
Casper	✓
Callahan	✓
Conrad	✓
DeLoach	✓
Evans	✓
Gale	✓
Rosen	✓
Sullivan	✓
Tavel	✓
Trotter	✓
Tele. Room	✓
Holmes	✓
Gandy	✓

John Roselli is a leading hoodlum in the Los Angeles area with important connections in Las Vegas gambling casinos. On the evening of June 20, 1963, the Los Angeles Office developed information indicating Roselli was departing from Los Angeles for Washington, D. C., under an assumed name of J. Ralston. Upon arrival in Washington, D. C., it was determined Roselli was met by an individual later identified as William K. Harvey, former Bureau Agent and now with Central Intelligence Agency (CIA).

The Liaison Section determined from CIA that CIA is utilizing Roselli in connection with Cuban matters.

It is known that CIA approximately two years ago had enlisted the aid of Chicago hoodlum Sam Giancana in a plan to neutralize Cuban leader Fidel Castro. In this connection we determined that former Bureau Agent Robert Maheu, presently conducting private investigations, was utilized by CIA as an intermediary. While we have no specific proof of this, we believe that the approach to Giancana by CIA was made by Maheu through Roselli.

ACTION:

Papich of the Liaison Section is obtaining full details of CIA's interest in Roselli this morning. You will be advised of further developments in this connection.

- 1 - Mr. Sullivan
- 1 - Mr. Papich

CHS:sma
(7)

ALL INFORMATION CONTAINED

HEREIN IS UNCLASSIFIED

DATE 3/3/81 BY SP4-jmb/kca

CIA Info Unclass per let of John E. Bacon 8/27/80

62 JUL 15 1963

REC-73

ST-115

13 JUL 2 1963

PER. REC. UNIT

ACT-72-2267490

JUL 10 1963

FEDERAL BUREAU OF INVESTIGATION

REPORTING OFFICE LOS ANGELES	OFFICE OF ORIGIN LOS ANGELES	DATE 7/15/63	INVESTIGATIVE PERIOD 6/3 - 7/10/63
TITLE OF CASE JOHN ROSELLI, aka		REPORT MADE BY [REDACTED]	TYPED BY MLJ
<p>ALL INFORMATION CONTAINED HEREIN IS UNCLASSIFIED 7070q# 22,330 DATE <u>3/13/81</u> BY <u>SP4-jmm/ka</u></p>		CHARACTER OF CASE AR	

13
 26
 27
 28
 29

REFERENCES: Report of SA [REDACTED] dated 6/5/63 at Los Angeles.
 Bureau airtel to Los Angeles 5/29/63.
 Las Vegas teletype to Los Angeles 6/6/63.
 Las Vegas radiogram to Los Angeles 6/4/63.
 Las Vegas airtels to Los Angeles 6/4/63; 6/7/63 and 6/18/63.
 Los Angeles teletype to Las Vegas 5/31/63.
 Los Angeles airtel to Bureau 6/3/63.
 Los Angeles airtel to New York 6/11/63.
 Newark memo to Los Angeles 6/19/63.
 St. Louis airtel to Los Angeles 6/25/63.

-P-

ENCLOSURES

TO BUREAU

APPROVED <i>[Signature]</i>	SPECIAL AGENT IN CHARGE	DO NOT WRITE IN SPACES BELOW	
COPIES MADE: 4 - Bureau (92-3267) (207) 1 - USA, Los Angeles (Attn: AJSA TIMOTHY M. THORNTON) 2 - Las Vegas (92-467) 2 - Los Angeles (92-113)		92-3267-499	REC-37
		10 JUL 19 1963	801 EX 108
Dissemination Record of Attached Report		COPIES DESTROYED MAY 25 1972	
Agency	1 Com Div P	STAT/STRICT	
Request Recd.	7/29/63		
Date Fwd.			
How Fwd.			
By	1 CC D & P		

51 AUG 1 1963

LA 92-113

INFORMATION REGARDING
ROSSELLI'S TRIP TO
WASHINGTON, D. C.
6/20 - 21/63

As set out in the investigative section of this report, ROSSELLI traveled to Washington, D. C. from Los Angeles on 6/20/63 leaving at 1:00 p.m. on TWA Flight 60 and returned to Los Angeles the following day on United Airlines and on both trips he traveled under the name J. RALSTON.

The following information is contained in Richmond airtel to the Director dated 6/21/63:

The Los Angeles Division, during the late afternoon of 6/20/63, telephonically requested the Richmond Division to conduct a physical surveillance of subject, who was then enroute to the Dulles International Airport, via Transworld Airlines, Flight 60, due to arrive at 8:15 pm. The flight originated in Los Angeles, California.

Physical surveillance at the Dulles International Airport revealed that subject arrived at 8:28 pm. He was met by a man and woman driving a 1963 Ford Fairlane Ranch Wagon, bearing Maryland license DF 78-69, registered to WILLIAM KING HARVEY of 28 W. Irving St., Chevy Chase 15, Montgomery Co., Maryland. The subject, with unknown man and woman, departed in above station wagon from Dulles International Airport at 8:35 pm and proceeded to Washington, D.C., where the automobile was parked in the 1700 block of Wisconsin Ave., N.W. The subject and his two companions were then observed as they entered Tino's Continental Restaurant at 9:13 pm. Richmond Agents continued the surveillance in this area until 10:50 pm, at which time the surveillance was turned over to Agents of the WFO Office.

LA 92-113

The following investigation was conducted by WFO based on telephonic request received from Alexandria RA on 6/20/63.

WFO Agents assumed fisur of the subject at 10:50 P.M., 6/20/63. At that time WFO was advised that the subject, accompanied by unknown white male and white female, were dining in Tino's Continental, 1721 Wisconsin Avenue, N.W., Washington, D. C., and that they had proceeded there from Dulles Airport, Va., in a late model white Ford Ranch Wagon, bearing 1963 Maryland license DF 7869.

Records of the Maryland Motor Vehicle Bureau reflect that license DF 7869 is registered to WILLIAM KING HARVEY, 28 West Irving Street, Chevy Chase, Md. WILLIAM KING HARVEY is a former Bureau Agent and currently holds a high position with CIA.

Bureau Liaison determined that the subject would be a house guest of WILLIAM KING HARVEY on the night of 6/20/63 and that he planned to depart Washington, D. C. 6/21/63. It was further determined that the subject may be engaged in a CIA operation.

In view of the above WFO discontinued fisur at 11:20 P.M., 6/20/63.

By memo dated 6/25/63, the Bureau advised the Los Angeles Office that the Bureau had determined from CIA that during his recent trip to Washington, D. C., ROSSELLI was in contact with a representative of CIA and that CIA advised the Bureau that ROSSELLI has periodically indicated that he was in a position to be of assistance regarding Cuban matters. CIA also advised that this last meeting between ROSSELLI and a representative of CIA was to close out this entire matter. ROSSELLI has not been given any financial remuneration by CIA and CIA has never made any commitments to ROSSELLI.

-E-

COVER PAGE

LA 92-113

The Bureau advised that this was for the confidential information of the Los Angeles Office and should not be set forth in an investigative report.

By memo dated 6/27/63, the Bureau advised that WILLIAM KING HARVEY was the representative of CIA who handled contacts with ROSSELLI.

It is noted that when ROSSELLI made reservations to return to Los Angeles on 6/21/63, he left a number where he could be reached as OL 2-1829.

On 7/10/63, the Los Angeles City Public Library Information Service advised that the residence telephone number of WILLIAM KING HARVEY is OL 4-5178.

The WFO will be requested by separate communication to ascertain the subscriber to Telephone No. OL 2-1829.

INFORMANTS

Careful consideration has been given to each source concealed and "T" symbols were utilized only in those instances where the identities of the sources must be concealed.

b2
b7C
b7D
OS

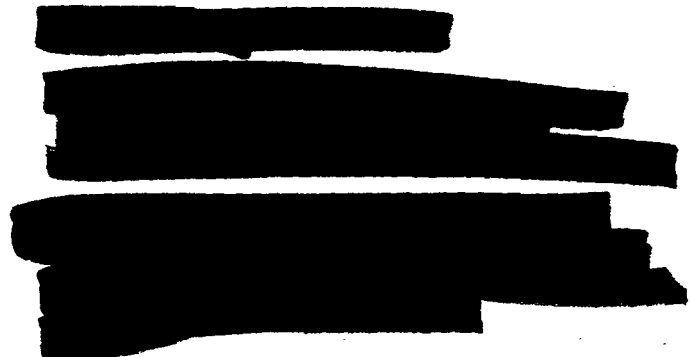

LA 92-113
HFD:rg

TABLE OF CONTENTS

	<u>Page Number</u>
CURRENT RESIDENCE	2
BIRTH DATA	2 - 5
CURRENT ACTIVITIES	5 - 12
CONTACTS AND ASSOCIATES	13 - 37
[REDACTED]	13 - 19
ROBERT A. MAHEU	20 - 25
[REDACTED]	26 - 27
[REDACTED]	26 - 27
[REDACTED]	27 - 36
[REDACTED]	37
[REDACTED]	37
LEGITIMATE ENTERPRISES	38 - 40
SALE OF ICE MACHINES	38 - 40
CLEANING ESTABLISHMENT	39 - 40
[REDACTED]	40 - 42
[REDACTED]	40 - 41
[REDACTED]	42
INDEX	43 - 47

b7C
OS

b7D
OS

8
LA 92-113
HFD:rg

~~ROBERT A. MAHEU
642 Toyopa Drive
Pacific Palisades, California
Robert A. Maheu and Associates~~

Information has been previously set out that on March 21, 1963, ROSSELLI desired to get in touch with ROBERT MAHEU, and that on May 1, 1963, ROSSELLI was called at the Desert Inn Hotel in Las Vegas by a Mr. MAHEU who left telephone number of Granite 8-1269, in Los Angeles. U

- The current Los Angeles telephone directory reflect that 478-1269 is listed to Robert A. Maheu and Associates, 10889 Wilshire Boulevard, West Los Angeles, California. U

Information has been set out previously in this investigation reflecting that ROBERT MAHEU who operates a private investigative firm, is quite well acquainted with JOHN ROSSELLI. U

Date 6/19/63

The following information was made available

[REDACTED]

ROBERT A. MAHEU, 155 South Bristol, Los Angeles, California,
EX 5-3523

telephone number EX 5-8888,

ROBERT A. MAHEU and Associates, 1125 19th Street, Northwest
Washington, D. C.

ROBERT A. MAHEU at 642
Toyopa Drive, Pacific Palisades, California.

ROBERT A. MAHEU and Associates at the Washington, D. C.

[REDACTED]

- 21 -

On 6/19/63 at Los Angeles, California File # LA 92-113

by SE [REDACTED]/rg Date dictated 6/19/63

b7c
b7D

2
LA 92-113

b7C
b7D

[REDACTED]

[REDACTED]

Pacson
93-7201
Glendale, Arizona
[REDACTED]

3/2/63
4/2/63
3/23/63
3/13/63
1/7/63
2/5/63
3/5/63

3 -
IA 92-113

[REDACTED]

[REDACTED]

[REDACTED]

b7C
b7D

[REDACTED]

[REDACTED]

[REDACTED]

4 -
IA 92-113

[REDACTED]

[REDACTED]

[REDACTED]

[REDACTED]

[REDACTED]

[REDACTED]

[REDACTED]

[REDACTED]

[REDACTED]

[REDACTED]

[REDACTED]

b7C
b7D
OS

5
LA 92-113

b7C
b7D

[REDACTED]

LA 92-113

INDEX

Page Numbers

AJAX WEST COAST CORPORATION

38

[REDACTED]

5, 37, 38

[REDACTED]

3

ARMORY LOUNGE

33

[REDACTED]

39

[REDACTED]

33

[REDACTED]

37

[REDACTED]

18, 19

[REDACTED]

14

[REDACTED]

15

[REDACTED]

7, 26

[REDACTED]

38

[REDACTED]

28

BEVERLY CLUB

16

[REDACTED]

29

CALIFORNIA JEWELSMITHS, INC.

16

[REDACTED]

27, 34, 35, 36

[REDACTED]

27, 28, 29, 30,
34, 35

[REDACTED]

39

[REDACTED]

37

57c
8

LA 92-113

INDEX CONTINUED

Page Numbers

[REDACTED]	14
[REDACTED]	10
[REDACTED]	26
HOLLYWOOD PERSONAL PROPERTY LEASING COMPANY	17
[REDACTED]	19
[REDACTED]	14, 15
[REDACTED]	15
[REDACTED]	12
[REDACTED]	16, 18
[REDACTED]	11
[REDACTED]	11
[REDACTED]	12
[REDACTED]	19
[REDACTED]	15
[REDACTED]	6, 26, 27
[REDACTED]	8, 13, 18
[REDACTED]	30
[REDACTED]	37
[REDACTED]	37
[REDACTED]	37
[REDACTED]	18, 19
MAHEU, ROBERT A.	20, 21

b7c
OS

INDEX CONTINUED

Page Numbers

MAHEU & ASSOCIATES, ROBERT A.

20, 21

[REDACTED]

9

[REDACTED]

33

[REDACTED]

15

[REDACTED]

5, 13

NOONAN ENTERPRISES

11, 12

NOONAN TAYLOR PRODUCTIONS

12

[REDACTED]

11

[REDACTED]

17

[REDACTED]

19

[REDACTED]

10

[REDACTED]

10

[REDACTED]

17, 18

[REDACTED]

38

[REDACTED]

27

[REDACTED]

5

[REDACTED]

29

[REDACTED]

39

[REDACTED]

39

[REDACTED]

15

[REDACTED]

42

[REDACTED]

14

[REDACTED]

37

b7c
OS

FEDERAL BUREAU OF INVESTIGATION

REPORTING OFFICE LOS ANGELES	OFFICE OF ORIGIN LOS ANGELES	DATE 8/19/63	INVESTIGATIVE PERIOD 7/11 - 8/14/63
TITLE OF CASE JOHN ROSELLI, aka		REPORT MADE BY [REDACTED] b7c	TYPED BY mjg
		CHARACTER OF CASE AR	

b7c

REFERENCES: Report of SA [REDACTED] dated 7/15/63 at Los Angeles.
 Los Angeles teletype to Las Vegas dated 7/18/63 (inter-office).
 Las Vegas teletype to Los Angeles dated 7/22/63 (inter-office).
 Los Angeles letter to WFO dated 7/24/63 (inter-office).
 Las Vegas letter to Los Angeles dated 7/31/63 (inter-office).
 Los Angeles letter to New York dated 8/7/63 (inter-office).
 Las Vegas airtel to Los Angeles dated 8/8/63 (inter-office).

-P-

ENCLOSURES

APPROVED: <i>[Signature]</i> SPECIAL AGENT IN CHARGE	DO NOT WRITE IN SPACES BELOW																										
COPIES MADE: <ul style="list-style-type: none"> 4 - Bureau (92-3267) (ENCLOSURE) 1 - USA, Los Angeles (Att: AUSA TIMOTHY M. THORNTON) 2 - Las Vegas (92-467) 2 - Los Angeles (92-113) 	<div style="font-size: 2em; font-weight: bold;">515</div> <div style="font-weight: bold;">REC-132</div> <div style="font-weight: bold; font-size: 1.5em;">103</div> <div style="text-align: center;">AUG 23 1963</div>																										
COPIES DESTROYED 8 25 MAY 25 1972	Notations <i>[Handwritten notes and signatures]</i>																										
<u>Dissemination Record of Attached Report</u>																											
<table border="1" style="width: 100%; border-collapse: collapse;"> <tr> <td style="width: 20%;">Agency</td> <td style="width: 20%;">Dept</td> <td style="width: 20%;">KLD DID</td> <td style="width: 20%;"></td> <td style="width: 20%;"></td> </tr> <tr> <td>Request Recd.</td> <td></td> <td></td> <td></td> <td></td> </tr> <tr> <td>Date Fwd.</td> <td>8/28/63</td> <td></td> <td></td> <td></td> </tr> <tr> <td>How Fwd.</td> <td>OOB</td> <td></td> <td></td> <td></td> </tr> <tr> <td>By</td> <td>[Signature]</td> <td></td> <td></td> <td>729</td> </tr> </table>		Agency	Dept	KLD DID			Request Recd.					Date Fwd.	8/28/63				How Fwd.	OOB				By	[Signature]			729	
Agency		Dept	KLD DID																								
Request Recd.																											
Date Fwd.	8/28/63																										
How Fwd.	OOB																										
By	[Signature]			729																							
59	AUG 29 1963																										

LA 92-113

TABLE OF CONTENTS

	<u>PAGE</u>
Current Residence	2
Birth Data	2 - 6
Current Activities	6 - 12
Contacts and Associates	13 - 57
[REDACTED]	13 - 21
[REDACTED]	21 - 23
ROBERT A. MAHEU	24 - 37
[REDACTED]	38
[REDACTED]	38 - 40
[REDACTED]	40 - 45
[REDACTED]	45 - 57
Legitimate Enterprises	58
Possible Investment in Apartment House in Las Vegas	58
[REDACTED]	58 - 63

b7C
OS

b7D
OS

LA 92-113
HFD:mjg

ROBERT A. MAHEU
642 Toyopa Drive
Pacific Palisades, California
Robert A. Maheu & Associates

The May, 1963 issue of a magazine entitled "Grapevine", which sets forth that it is the official publication of the Society of Former Special Agents of the FBI, Inc. on Page 37 contains an article headed "Maheu Office Moves". The article then states "The Washington D. C. office of Robert A. Maheu Associates is moving to 900 17th Street, N.W., Washington 6, D. C., Suite 316 effective July 1. u

"Society members ROBERT A. MAHEU and WILLIAM J. STATEN are at the Washington office of the firm which also has branches in Los Angeles and Tucson." u

The same issue of this publication on Page 24 contains an article which reads as follows: u

"Olsen In New Home" u

"CHARLES H. OLSEN, who is with Robert A. Maheu Associates at the firm's Los Angeles office, is now residing at 648 Ocampo Drive, Pacific Palisades, California." u

Information concerning [REDACTED]

[REDACTED] ROBERT A. MAHEU and Robert A. Maheu Associates were set out previously in this investigation. u

INDEX

PAGE

b7C
OS

[REDACTED]	44
[REDACTED]	46
[REDACTED]	47
[REDACTED]	7
[REDACTED]	47
[REDACTED]	19
[REDACTED]	13
[REDACTED]	57
[REDACTED]	47
[REDACTED]	14
[REDACTED]	57
[REDACTED]	18
[REDACTED]	49
[REDACTED]	34
[REDACTED]	33
[REDACTED]	17, 19
Calamigos Star C Ranch	18
[REDACTED]	57
[REDACTED]	40, 41
[REDACTED]	13, 15
[REDACTED]	25
[REDACTED]	46
[REDACTED]	51
[REDACTED]	47
[REDACTED]	6
[REDACTED]	46
[REDACTED]	46, 48, 52, 53
[REDACTED]	7
DOHENY Plaza Apartments	7
[REDACTED]	51
[REDACTED]	52
[REDACTED]	10

[REDACTED]	47
[REDACTED]	50
[REDACTED]	51
[REDACTED]	23
[REDACTED]	21, 22, 23
[REDACTED]	61
[REDACTED]	19
[REDACTED]	49
[REDACTED]	11, 12, 14, 45, 46
[REDACTED]	12, 45, 53, 54, 55, 56, 57

MAHEU, ROBERT A.	24
MAHEU Associates, ROBERT A.	24
Manpower, Incorporated	35
[REDACTED]	3, 6
MARLOW and Associates, HAL	34
Martoni's	3, 4, 6, 49

b7C
OS

[REDACTED]	45
[REDACTED]	50
[REDACTED]	36
[REDACTED]	51, 55
[REDACTED]	15

NATHANSON Enterprises, JERRY	42
[REDACTED]	38

[REDACTED]	33
[REDACTED]	50
[REDACTED]	50
[REDACTED]	24

[REDACTED]	47, 50
[REDACTED]	18
[REDACTED]	33
[REDACTED]	6

[REDACTED]	19
[REDACTED]	49
RISSMAN and RISSMAN	17
[REDACTED]	17

FEDERAL BUREAU OF INVESTIGATION

REPORTING OFFICE LOS ANGELES	OFFICE OF ORIGIN LOS ANGELES	DATE 10/8/63	INVESTIGATIVE PERIOD 8/15 - 9/27/63
TITLE OF CASE JOHN ROSELLI, aka		REPORT MADE BY [REDACTED] b7C	TYPED BY m.j.
		CHARACTER OF CASE AR	

REFERENCES: Report of SA **[REDACTED]** dated 8/19/63 at Los Angeles.
 (All communications inter-office)
 Los Angeles airtels to San Diego dated 8/22 and 9/9/63.
 Las Vegas airtels to Los Angeles dated 8/28, 9/4 and 9/12/63.
 Los Angeles airtels to Las Vegas dated 8/22, 8/31 and 9/12/63.
 Los Angeles teletypes to Las Vegas dated 8/28, 8/29 and 9/20/63.
 Boston letter to Los Angeles dated 8/30/63.
 Las Vegas teletypes to Los Angeles dated 8/29, 8/30, 9/21, 9/23 and 9/24/63.
 Los Angeles letter to New York dated 8/30/63.
 San Diego letter to Los Angeles dated 9/5/63.
 Houston letter to Los Angeles dated 9/11/63.
 Albany letter to Los Angeles dated 9/12/63.

APPROVED: *[Signature]*
 SPECIAL AGENT IN CHARGE
 COPIES MADE:
 4 - Bureau (92-3267) (ENCL. 4)
 1 - USA, Los Angeles (Att: AUSA TIMOTHY M. THORNTON)
 2 - Las Vegas (92-467) (ENCL. 1)
 2 - Los Angeles (92-113)

COPIES DESTROYED
 9 25 MAY 25 1972

Dissemination Record of Attached Report

Agency	Request Recd.	Date Fwd.	How Fwd.	By
<i>1-27</i>				

DO NOT WRITE IN SPACES BELOW

92-3267-524 REC 37

EX-1

OCT 11 1963

Notations

61 OCT 23 1963

LA 92-113

Information has previously been set out in this investigation that FRANK DESIMONE of Los Angeles is a close friend of JOHN ROSSELLI and attended the "Apalachin meeting" in November, 1957. ~

ROBERT A. MAHEU
642 Toyopa Drive,
Pacific Palisades, California
Robert A. Maheu & Associates

Information has been set forth previously in this investigation that ROSSELLI has on several occasions in the past been in contact with ROBERT A. MAHEU. In addition, [REDACTED] MAHEU's firm were set out. The following information pertains to the identity of the [REDACTED] ~

b7D

BETHESDA, MARYLAND

SA [REDACTED] ascertained that the current Polk's Directory for the Montgomery County, Maryland, area, including Bethesda, Maryland, in the telephone index section reflects that Telephone No. [REDACTED] is listed to a [REDACTED] ~

The alphabetical and street sections of the same directory reflect a [REDACTED] occupation lawyer, wife [REDACTED] residing at [REDACTED] (Bethesda), Maryland. ~

b7C

25

The 1962 edition of the Chesapeake and Potomac Telephone Company Directory for the Metropolitan Washington, D. C. area-Maryland edition, sets forth a listing for [REDACTED] Maryland, Telephone No. [REDACTED] business address [REDACTED], Washington, D. C., Telephone [REDACTED] ~

On August 28, 1963 a call placed to Telephone No. [REDACTED] determined that the number is still used by [REDACTED] an attorney in Washington, D. C. ~

LA 92-113

Greeley, Colorado, advised there has never been any indication that this consulting engineering firm has had business relationships with persons engaged in criminal activities.

BOSTON

[REDACTED]

The above information was furnished on a confidential basis and cannot be made public prior to the issuance of a subpoena duces tecum.

The Boston Office advised that Mrs. EPHREM MAHEU is the mother of former Special Agent ROBERT A. MAHEU.

HOUSTON

[REDACTED]

b7c
b7D
OS

LA 92-113

INDEX

Page

[REDACTED]	24
AMERICAN AERIAL SURVEY, INC.-----	28
[REDACTED]	15
[REDACTED]	25
[REDACTED]	25
AUTOMOBILE LICENSES - CALIFORNIA	
JMF-862-----	7
NZK-854-----	14
[REDACTED]	44
[REDACTED]	18, 19, 20, 25
[REDACTED]	25
[REDACTED]	25
[REDACTED]	25
[REDACTED]	9, 10
[REDACTED]	26
[REDACTED]	10
[REDACTED]	11, 23, 25
[REDACTED]	10
[REDACTED]	49
[REDACTED]	26
[REDACTED]	26
[REDACTED]	37
BENNETT TOURS, INC.-----	24
[REDACTED]	26
[REDACTED]	50, 51
[REDACTED]	51
[REDACTED]	30
[REDACTED]	25
[REDACTED]	49, 50
[REDACTED]	66
[REDACTED]	25
BRAVERMAN - MIRISCH, INC.-----	47
[REDACTED]	26
[REDACTED]	9, 70

b7C
OS

LA 92-113

[REDACTED]
MAHEU, MARS. EPHREM
MAHEU, ROBERT A.

MARTONI'S ITALIAN RESTAURANT

MASTER COLLECTORS

NEVADA CONCESSIONS, INC.

RAFT AGENCY

35
60
54
16
8, 12
35
18
70
13, 15, 48
34
62
34
49
34
34
35
47
47
23
47
34
48
41, 43
48
35
35
47
40
35
52
35
36
36
21, 22, 36

b7c
OS

FEDERAL BUREAU OF INVESTIGATION

REPORTING OFFICE LOS ANGELES	OFFICE OF ORIGIN LOS ANGELES	DATE 11/29/63	INVESTIGATIVE PERIOD 9/30 - 11/21/63
TITLE OF CASE JOHN ROSELLI, aka		REPORT MADE BY [REDACTED] b7C	TYPED BY m.jg
		CHARACTER OF CASE AR REC-21 EX-100 copy 10/14/37 b7C	

REFERENCES: Report of SA [REDACTED] dated 10/8/63 at Los Angeles.
 Mobile airtel to Los Angeles 10/7/63.
 Los Angeles airtel to Mobile 10/15/63.
 Las Vegas airtels to Los Angeles 10/7, 17, 11/5, 19/63.
 Las Vegas letter to Los Angeles 10/7/63.
 Los Angeles airtel to Las Vegas 10/14/63.
 Los Angeles teletype to Las Vegas 10/15/63.
 Las Vegas teletypes to Los Angeles 10/15 and 11/8/63.
 Los Angeles airtel to San Diego 10/15/63.
 Los Angeles airtel to New York 10/15/63.
 Los Angeles airtel to Miami 10/30/63.
 Los Angeles teletype to Bureau 11/16/63.
 Phoenix teletypes to Los Angeles and Las Vegas 11/17 and 18/63.

-P-

APPROVED <i>[Signature]</i>	SPECIAL AGENT IN CHARGE	DO NOT WRITE IN SPACES BELOW	
COPIES MADE: ④ - Bureau (92-3267)(ENCL. 4)(AM) 1 - USA, Los Angeles (Att: AUSA TIMOTHY M. THORNTON) 2 - Las Vegas (92-467)(ENCL. 1) 2 - Los Angeles (92-113)		92-3267-534 8 DEC 2 1963	REC
COPIES DESTROYED 9 25 MAY 25 1972			
Dissemination Record of Attached Report		Notations	
Agency	<i>[Handwritten]</i>	NINE STAR SECT	
Request Recd.	<i>[Handwritten]</i>		
Date Fwd.	<i>[Handwritten]</i>		
How Fwd.	<i>[Handwritten]</i>		
By:	<i>[Handwritten]</i>		
5 DEC 12 1963			

LA 92-113
HFD:mjg

b7C

On 11/5/63, SA [REDACTED] discussed with AUSA TIMOTHY M. THORNTON any possible benefit that might be served if a Grand Jury were convened in Los Angeles to inquire into the facts concerning ROSSELLI's birth. The facts known, bearing on ROSSELLI's birth were reviewed with THORNTON. u

OS

He stated that ROSSELLI would no doubt claim privilege under the 5th Amendment to any questions asked concerning his birth and thereafter the Grand Jury would have nothing to work on. THORNTON added that unless there is evidence of some current declaration by ROSSELLI in a Federal matter concerning his birth, there does not appear to be any jurisdiction and added that, if in fact, the birth records are false, it is really a violation against the state laws of Illinois. u

INFORMATION CONCERNING [REDACTED]
[REDACTED] ROBERT A. MAHEU &
ASSOCIATES

CP-1

b7D

For the past several months, at the request of the Bureau, [REDACTED] Robert A. Maheu & Associates have been obtained by the Los Angeles Office and the appropriate office [REDACTED] were located [REDACTED] have furnished [REDACTED]

In previous reports some of these [REDACTED] have been set forth. The purpose of ascertaining [REDACTED] was to determine if MAHEU was in contact with persons in the criminal element.

A review of the names of [REDACTED] and the information concerning them furnished by the other Offices which is quite voluminous, has revealed no instances where it is evident that MAHEU has contacted people engaged in criminal activities or having criminal backgrounds. u

LA 92-113
HFD:mjg

b7D } In view of this, the material received from the other Offices concerning [REDACTED] will be indexed and maintained in instant file, but will not be reported in this report as it appears that it would serve no beneficial purpose. No further efforts are being made to obtain MAHEU's [REDACTED] u

INVESTIGATION BY IRS
LOS ANGELES, CALIFORNIA

On 11/5/63, the agents from IRS who are conducting the ROSSELLI investigation, together with their supervisors, met with AUSAs TIMOTHY M. THORNTON and BENJAMIN S. FARBER, Special Prosecutive Section, U. S. Attorney's office, Los Angeles for the purpose of discussing the IRS investigation of ROSSELLI.

OS }
pertains
strictly
to
ROSSELLI

[REDACTED]

INFORMANTS

Careful consideration has been given to each source concealed and "T" symbols were utilized only in those instances where the identities of the sources must be concealed. u

UNITED STATES GOVERNMENT

Memorandum

TO : DIRECTOR, FBI (92-3267)

DATE: 12/5/63

FROM : *EEB/jw* SAC, RICHMOND (92-264) - RUC -

SUBJECT: JOHN ROSELLI, aka
AR

(OO: LOS ANGELES)

ALL INFORMATION CONTAINED
HEREIN IS UNCLASSIFIED *FOIPA # 22,330*
DATE 3/3/81 BY SP4-jm/kzw
CIA info unclass per let of John E. Bacon 8

92-3267-522

Re Richmond letter to Bureau dated 9/27/63. *u*

SA [redacted] on 11/29/63, was advised by [redacted] Governor Hill Apartments, 5111 S. 8th Road, Arlington, Va., that [redacted] with one [redacted] moved into those apartments during January, 1963. In the first part of April, 1963, they were having financial problems and sublet the apartment to three girls who resided there until August, 1963.

Presently, [redacted] and one [redacted] continue to occupy Apartment [redacted] at 5111 S. 8th Road, Arlington, Va. [redacted] is supposedly residing in the Seminary Towers Apartments, Alexandria, Va. *B. APPROX 194*

[redacted] advised that [redacted] who was 21 years of age during January, 1963, was, at that time, an employee of the Bank of Commerce, Washington, D. C., and may possibly be employed there at the present time.

*b7C
b7D
OS*

*b7C
b3
per
(1A)
OS*

REC 5 92-3267-544

- ② - Bureau
 - 2 - Los Angeles (92-113)
 - 2 - WFO (92-715)
 - 1 - Richmond
- HER/mw
(7)

6 DEC 6 1963

EX-115

*let LA
Richmond
12-26-63
J. Williams*

Page ch.

[Handwritten initials and signatures]

The current Virginia edition of the Chesapeake and Potomac Telephone Directory for the Washington, D. C.-Metropolitan area, reflects that one [redacted] resides at [redacted] Seminary Road, Alexandria, Virginia, where the telephone number is [redacted]. It should be noted that this is the address of the Seminary Towers Apartments in Alexandria, Virginia, and this individual is probably identical with the [redacted] who previously resided at 5111 S. 8th Road, Arlington, Va. U

D.C.

[redacted] Secretary to the Director of Security Services for the Secretary of Defense, at the Pentagon Building, Arlington, Virginia, on 11/29/63, advised SA [redacted] that a check of various Defense Department Agencies was made by her office in an effort to identify [redacted] who maybe employed as a Communications Worker for the U. S. Government. These checks were made with negative results. [redacted] stated that in view of the fact that these checks were negative, it is the opinion of her office that [redacted] is not employed in any section of the Defense Department. She pointed out, however, that many of the services do have some independent personnel offices and it is possible for a person to be employed in the Department of Defense and this employment might not come to the attention of her office even when specific checks have been made.

b7c
OS

LEADS:

REQUEST OF BUREAU

The Bureau through liaison is requested to verify [redacted]

OS
b3
per
CIA

WASHINGTON FIELD OFFICE

AT WASHINGTON, D. C.

1. Is requested to contact the Bank of Commerce to determine whether or no [redacted] is still employed there. Will attempt to obtain detailed background information concerning him. U

b7c
OS

POB
12/14/63

RH 92-264

2. Will contact U.S. Civil Service Commission to determine whether or not an individual by the name of [REDACTED] Falls Church, Va., is employed by the U. S. Government as a Communications Worker. u

3. Will conduct a credit check concerning [REDACTED] to determine if any information has come to the attention of the [REDACTED] Bureau, Washington, D. C., concerning this individual. u

Unless advised to the contrary by the office of origin or the Bureau, the Richmond Division does not contemplate neighborhood inquiries concerning [REDACTED] and will take no further action to try and identify him at this time. Any additional inquiry concerning him should be requested by a further communication. u

b7C
b7D
QS

SAC, Los Angeles (92-113)

12/26/63

Director, FBI (92-3267) - 544
REC-121

mt

JOHN ROSELLI, aka.
AR

X-102

Re Richmond letter 12/5/63. u

[REDACTED]

OS b3 per CIA

1 - Richmond (92-264)

NOTE: Robert A. Maheu, former Bureau Agent, operates a private investigative agency in Los Angeles. His firm has been contacted in the past by subject Roselli and the Los Angeles Office has been checking toll calls charged to Maheu's firm to determine if Maheu was in contact with persons in the criminal element. One of these calls was made to an Arlington, Virginia, apartment occupied by [REDACTED] and [REDACTED].

b7c OS

VFL: rap *fab*
(5) *JA*

ALL INFORMATION CONTAINED
HEREIN IS UNCLASSIFIED 70EPA #22,330
DATE 3/3/81 BY SP4-jm/kaw
CIA Info unclass per let of
John E. Bacon 8/27/80

MAILED 4
DEC 26 1963
COMM-FBI

- Tolson _____
- Belmont _____
- Mohr _____
- Casper _____
- Callahan _____
- Conrad _____
- DeLoach _____
- Evans _____
- Gale _____
- Rosen _____
- Sullivan _____
- Tavel _____
- Trotter _____
- Tele. Room _____
- Holmes _____
- Gandy _____

F 29
JAN 3 1964

MAIL ROOM TELETYPE UNIT

DEC 26 1963

FBI

Date: 5/9/64

Transmit the following in _____
(Type in plain text or code)

Via AIRTEL AIRMAIL
(Priority)

TO: DIRECTOR, FBI (92-3267)
FROM: SAC, LOS ANGELES (92-113-C)
JOHN ROSELLI, Aka
AR

The Bureau has been advised that ROSSELLI and a red-haired girl named _____, aka, were observed arriving in Las Vegas together on 4/20/64.

_____ denied that she and ROSSELLI were traveling together and said that she had not been with ROSSELLI, although they were on the same plane. In this regard, information was also furnished the Bureau that on _____ ROSSELLI was in Santa Barbara with a woman. Photograph of _____ will be shown to _____ to determine if she is the girl who was with ROSSELLI.

b7C
b7D
OS

On 5/4/64 the Las Vegas Office advised that _____ furnished information that on 2/28/64 ROSSELLI called ROBERT MAHEW (phonetic), telephone number 454-6535, Santa Monica, California, (from the Desert Inn Hotel, Las Vegas). (This is the telephone number of ROBERT MAHEW, 642 Toyopa Drive, Pacific Palisades, California, and the Bureau is aware of MAHEW's identity and association with ROSSELLI.) _____ further advised that the arrival sheets reflecting guests checking into the Desert Inn Hotel reflects that a Mr. and Mrs. R. MAYHEW (phonetic) checked into this hotel on 4/28/64.

b2
b7
b2

3-Bureau
1-Las Vegas (92-467)(AM)
1-Los Angeles
hfd:dlb
(5)

REC-123

2 MAY 11 1964

EX 101

92-3267-579

[Handwritten signature]

6 MAY 15 1964

Approved: _____ Sent _____ M Per _____
Special Agent in Charge

D.C. Wick

FEDERAL BUREAU OF INVESTIGATION

REPORTING OFFICE LOS ANGELES	OFFICE OF ORIGIN LOS ANGELES	DATE 6/4/64	INVESTIGATIVE PERIOD 3/23 - 5/26/64
TITLE OF CASE JOHN ROSELLI, aka		REPORT MADE BY [REDACTED] b7C	TYPED BY ljg
		CHARACTER OF CASE AR	

REFERENCES: Report of S. [REDACTED] dated 3/26/64 at Los Angeles.
 Las Vegas teletypes to Los Angeles 3/22/64; 4/2, 10, 16, 28/64; 5/11/64.
 Los Angeles airtel to Las Vegas 4/14/64.
 Las Vegas airtels to Los Angeles 4/16, 27/64; 5/7, 11/64.
 Chicago airtel to Los Angeles 5/8/64.

-P-

ENCLOSURES

TO BUREAU

Two (2) copies of a letterhead memorandum setting forth characterization of informants utilized in this report.

APPROVED: <i>[Signature]</i>	SPECIAL AGENT IN CHARGE	DO NOT WRITE IN SPACES BELOW	
COPIES MADE:		77-3267-586	REC-16
4 - Bureau (92-3267) (ENCL-4)			ST-112
1 - USA, Los Angeles (Att: AUSA TIMOTHY M. THORNTON)		JUN 5 1964	
2 - Las Vegas (92-467)			
2 - Los Angeles (92-113)			
COPIES DESTROYED 9 25 MAY 25 1972			
Dissemination Record of Attached Report		Notations	
Agency		[Handwritten Notations and Stamp: STATE SECRET]	
Request Recd.	<i>See Reportment</i>		
Date Fwd.	<i>6-10-64</i>		
How Fwd.	<i>See Reportment</i>		
By			

64 JUN 22 1964

LA 92-113
HFD:mjg

TABLE OF CONTENTS

	<u>Page</u>
CURRENT RESIDENCE-----	3 - 4
CURRENT ACTIVITIES-----	4 - 10
CONTACTS AND ASSOCIATES-----	10 - 20
[REDACTED]-----	10 - 12
[REDACTED]-----	12 - 14
[REDACTED]-----	14 - 17
[REDACTED]-----	18
[REDACTED]-----	18 - 19
ROBERT A. MAHEU-----	19
[REDACTED]-----	19
[REDACTED]-----	20
CRIMINAL ACTIVITIES-----	20 - 21
LEGITIMATE ENTERPRISES-----	21 - 22
SALE OF ICE CUBE MACHINES-----	21 - 22
[REDACTED]-----	22 - 36
[REDACTED]-----	22 - 28
[REDACTED]-----	28 - 32
[REDACTED]-----	32 - 36
HEALTH-----	36 - 37

b7C
Q5

b7D
Q5

LA 92-113

On April 10, 1964, a Special Agent of the FBI observed a Lincoln Continental, sedan, bearing California license GWB 295, parked in front of 8116 Amore Road, at about 1:00 PM. u

On April 13, 1964, the Department of Motor Vehicles, Los Angeles, furnished information that California license GWB 295, is listed to a 1962 Lincoln Continental, sedan, registered to U. S. U-Drive, 124 North Harbor Boulevard, Santa Ana, California. u

b2
b7C
b7D On [redacted] advised that [redacted] resides at 2325 Delmar Drive, Largo, Florida. u

ROBERT A. MAHEU
642 Papaya Drive
Pacific Palisades, California

b2
b7D On [redacted] advised that on April 28, 1964, ROSSELLI made a telephone call to ROBERT MAHEU, (phonetic), at Santa Monica, California, telephone 454-6535, and that arrival sheets at the Desert Inn Hotel, reflect that a Mr. and Mrs. R. MAHEU, checked into the Desert Inn Hotel on April 28, 1964. u

Information has been previously reported in this matter that telephone GL 4-6535, is a non-published number of ROBERT A. MAHEU, 642 Toyopa Drive, Pacific Palisades, California. Information has also been set out that MAHEU, a private investigator, and former FBI Agent, has been in contact with ROSSELLI on numerous occasions in the past. u

[redacted]
Beverly Hills, California
telephone [redacted]

b2
b7C
b7D
OS On May 11, 1964, IC [redacted] ascertained that the [redacted] in Los Angeles has no record concerning [redacted]

LA 92-113
HFD:mjg

INDEX

PAGES

[REDACTED]	6
[REDACTED]	27, 29, 30,
[REDACTED]	31, 32
AJAX WEST COAST CORP.	21, 22, 24
[REDACTED]	11
[REDACTED]	31
ARNOLD'S INTERNATIONAL TRAVEL AGENCY	30
AUTO LICENSES	
NEVADA CR 9679	17
NEVADA C 39115	15, 7
CALIFORNIA QUG 442	34
[REDACTED]	6
[REDACTED]	13
BRAND LEASE PLAN	33, 34
[REDACTED]	5, 6
[REDACTED]	21
[REDACTED]	21
[REDACTED]	21
[REDACTED]	18
[REDACTED]	18
[REDACTED]	27, 32, 33,
[REDACTED]	34, 35
COLUMBINE II	11
CONCUBINE II	11
[REDACTED]	29, 30
[REDACTED]	17
[REDACTED]	5, 20
[REDACTED]	5
[REDACTED]	7
DE LUCA CLUB, THE JOHN	24
DESERT INN HOTEL	24
[REDACTED]	35

b7C
DS

LA 92-113
HFD:mjg

[REDACTED]

31
8
4, 9
5, 6
18
18
18

MAHEU, ROBERT A.

[REDACTED]

19
35
10, 11
11, 12
3

NUTRALITE PRODUCTS, INC.

[REDACTED]

36
18
35
12

67
OS

PACIFIC VITAMIN CORP.

PERLINO'S RESTAURANT

[REDACTED]

[REDACTED]

[REDACTED]

[REDACTED]

36
12, 13
9, 20, 24
6, 27, 29,
30, 31, 32
9, 20
17
14
26, 27, 28,
31, 32, 33
17

SANSUM MEDICAL CLINIC

SELENA ENTERPRISES, INC.

[REDACTED]

7, 36
29, 30
28, 29, 30,
31, 32
11

5/24/66

Airtel

FOIPA # 22,330

DECLASSIFIED BY SP4 - Jpm/tae
ON 3/4/81

To: SAC, Los Angeles (92-113)

CIA Info Declassed per let of
John E. Bacon 8/23/80

From: Director, FBI (92-3267)

**JOHN ROSELLI, aka
ANTI-RACKETEERING**

~~TOP SECRET~~

Classified by 6049
Exempt from 2
Date of Declassification 11/28/77
ecj as

Re your airtel 5-16-66.

Enclosed for your confidential information is a copy of a memorandum from Central Intelligence Agency (CIA) reflecting a contact by Roselli with Colonel Sheffield Edwards, former Director of Security of CIA. This information should not be disseminated outside of your office. *IS(u)*

Obviously, the contact by Los Angeles Agents with Roselli touched a sensitive spot with Roselli and has apparently unnerved him. While protecting the confidential nature of this information you should be alert to the potential this development has in making any further contacts with Roselli. *IS(u)*

You should keep the Bureau promptly advised of further developments in this matter. *u*

Enc.

1 - Los Angeles (137-2602)

1 - Mr. J. E. Kelly, Jr.

~~TOP SECRET~~

92-3267-700

REC 37

4 MAY 25 1966

- Tolson _____
- DeLoach _____
- Mohr _____
- Wick _____
- Casper _____
- Callahan _____
- Conrad _____
- Felt _____
- Gale _____
- Rosen _____
- Sullivan _____
- Tavel _____
- Trotter _____
- Tele. Room _____
- Holmes _____
- Gandy _____

PJM:skh
(6) *pkh*

MAILED 27
MAY 24 1966
COMM. FBI

57 MAY 31 1966 TELETYPE UNIT

Pjm

d

UNITED STATES GOVERNMENT

Memorandum

<input checked="" type="checkbox"/>	Tolson
<input checked="" type="checkbox"/>	DeLoach
<input checked="" type="checkbox"/>	Mohr
<input checked="" type="checkbox"/>	Casper
<input checked="" type="checkbox"/>	Callahan
<input checked="" type="checkbox"/>	Conrad
<input checked="" type="checkbox"/>	Felt
<input checked="" type="checkbox"/>	Gale
<input checked="" type="checkbox"/>	Rosen
<input checked="" type="checkbox"/>	Sullivan
<input checked="" type="checkbox"/>	Tavel
<input checked="" type="checkbox"/>	Trotter
<input checked="" type="checkbox"/>	Tele. Room
<input checked="" type="checkbox"/>	Holmes
<input checked="" type="checkbox"/>	Gandy

TO : Mr. DeLoach

DATE: May 23, 1966

DECLASSIFIED BY SP4-jm/ka
ON 3/4/81

FROM : J. H. Gale CIA Info declassified per
Let John E. Bacon 8/27/80

Classified by

SUBJECT: JOHN ROSELLI, also known as
ANTI-RACKETEERING

~~TOP SECRET~~ 11/28/77
6049-9-1
22-1
DECLASSIFIED
TOP SECRET

The Central Intelligence Agency recently advised of a contact Roselli made with Colonel Sheffield Edwards, former Director of Security, now retired. Roselli, a member of the Chicago "family" of La Cosa Nostra who represents their interests in Las Vegas and on the west coast, was contacted by Agents of the Los Angeles Division shortly before this and they apparently touched a sensitive spot. Colonel Edwards, who obviously contacted Roselli in the past, thought he looked worried and distraught. The contact by our Los Angeles Agents flushed Roselli out and he went to the Central Intelligence Agency for protection. Central Intelligence Agency, in the past, compromised themselves by dealing with Roselli when they had him contact Sam Giancana, head of the Chicago "family" of La Cosa Nostra, to get someone to assassinate Castro. *AS(w)*

Los Angeles Agents recently selected Roselli as a target to develop him as a top echelon criminal informant and in the alternative to put pressure on him to develop information leading to his possible deportation. Los Angeles has developed information through a [redacted]

b7D [redacted] that Roselli's true name is Felipe Sacco, that he was brought to the United States as a child and his mother, an alien, still resides in Boston, Massachusetts. In Roselli's youth, he assumed the name John Roselli, using this identity to the present time. *TOP SECRET*

REC 70 *72-3267-702*
On May 6, 1966, Agents in the Los Angeles Division contacted Roselli in Beverly Hills, California, and confronted him with compromising information concerning his true identity. The Agents suggested that Roselli secretly meet them to discuss this matter. About one hour after Roselli was contacted, James Cantillon, Roselli's attorney, called the Los Angeles Office and told the contacting Agent that if the FBI desired to

- 1 - Mr. DeLoach
- 1 - Mr. Sam Papich
- 1 - Mr. Gale
- 1 - Mr. McAndrews
- 1 - Mr. P. J. Mohr

MAY 25 1966

CONTINUED - OVER

PJM:tjm
(6)

9-Pjm

Memorandum to Mr. DeLoach
Re: John Roselli

interview Roselli, it would have to be done in Cantillon's presence. Cantillon was told we desired to interview Roselli, but not in the presence of an attorney. Shortly after the contact was made with Roselli, he suddenly departed Los Angeles, as now determined from Central Intelligence Agency, to secretly make contact with that agency. ~~XS~~(u)

ACTION:

This matter will be followed with the Central Intelligence Agency through the Liaison Section. The Los Angeles Office will be advised of Roselli's contact with Central Intelligence Agency so they can capitalize on his inner turmoil to develop him as a top echelon criminal informant regarding his vast knowledge of the Chicago La Cosa Nostra. ~~XS~~(u)

✓

~~TOP SECRET~~

Dgh

GRU

pod
S

you

MS
gh
Malt

FBI

Date: 11/18/66

701P# 22, 330

Transmit the following in _____

DECLASSIFIED BY SP4. gmm/Kar

(Type in plain text or code) ON 3/4/81

Via AIRTEL

AIR MAIL - REGISTERED
(Priority)

CIA Info Declassified Per
John E. Budon 8/27/80

ST
M

TO: DIRECTOR, FBI (92-3267)
FROM: SAC, LOS ANGELES (92-113)
RE: JOHN ROSELLI, aka
AR

~~TOP SECRET~~

Classified by 6049
Classified by 6049
Exempt from GDS, Category 2
Date of Declassification Indefinite
11/20/11
CP/MS

Investigation has established that ROSELLI is an alien whose true identity is PHILIP or FILIPPO SACCO. For more than two years, investigation has been conducted to endeavor to uncover some crime committed by ROSELLI, which would have caused him to change his identity, and to locate witnesses who have knowledge of his true name. No evidence of a prosecutable crime was uncovered. U

In May, 1966, ROSELLI was approached by Agents of the Los Angeles Office and was advised that the FBI had knowledge of his birth in Italy and the fact that his true name was PHILIP SACCO. After several contacts by ROSELLI's attorney concerning this matter, he agreed to permit ROSELLI to be interviewed by one Agent. This was done and his cooperation was solicited. The day following the interview ROSELLI's attorney advised ROSELLI would not be seeing Agents again. U

- ③ - Bureau (ENCL.6) 2cc d+d
- 2 - Boston (92-458)(AM-RM)
- 1 - Chicago (92-399)(info)(AM-RM)
- 2 - Miami (92-517)(AM-RM)
- 1 - New York (92-721)(info)(AM-RM)
- 2 - Washington Field (92-715)(ENCL.2)(AM-RM)
- 2 - Los Angeles

HFD/mjg
(13)

APPROPRIATE AGENCIES
AND FIELD OFFICES
ADVISED BY ROUTING
SLIP(S) OF DECLASSIFIED
DATE 3-25-81 SH

ST. 104

92-3267-728

cc sent to Legat, Rome
by C-7, 12-6-66
MER: mjk

AIRTEL TO LA
12-6-66
MER: mjk

REC-34

14 NOV 21 1966

Approved: _____
Special Agent in Charge

Sent _____ M Per _____

~~TOP SECRET~~

[Handwritten signature]

LA 92-113

Since May, 1966, when ROSELLI was interviewed by Agents of the Los Angeles Office, information has been obtained from various sources that he has been concerned and worried; that he stays at his apartment much more than he formerly did; that he travels to Las Vegas less frequently, and on several of the trips he has taken to Las Vegas, he has been accompanied by his attorney, JAMES CANTILLON. Information has also been obtained by an informant that ROSELLI has indicated to a girl friend the possibility that he might be deported. ~

Subsequent to the receipt of the informant information concerning ROSELLI's true identity and over the course of the past two years, extensive investigative effort has been undertaken by the FBI exclusively in an effort to develop: (a) A Federal violation, (b) Locate witnesses in a position to testify concerning ROSELLI's true identity, and (c) To develop him as an informant for the FBI. ~

Los Angeles makes the following observations: ~

With regard to (a) above, Los Angeles deeply feels that the name change was to cover up a serious crime, for example a capital offense. Investigation has not established what this offense might be. If the name change was not as a result of a capital crime, his purpose, therefore, must have been to cover his alien status. ~

Therefore, Los Angeles recommends that based on investigation conducted, the following courses of action take place in the immediate future: ~

① That the Bureau authorize the Washington Field Office to interview Colonel SHEFFIELD EDWARDS, the former Director of Security, CIA, who presently heads the firm Sheffield Edwards Associates, 1815 H Street, N.W., Washington, D.C.

For background, the Bureau by airtel to Los Angeles dated 5/24/66, enclosed a confidential report reflecting a contact JOHN ROSELLI made with Colonel SHEFFIELD EDWARDS,

LA 92-113

former Director of Security, CIA, shortly after ROSELLI was contacted by Bureau Agents in Los Angeles in May, 1966. Among other things, ROSELLI told Colonel EDWARDS that the Agents gave him a picture of himself (ROSELLI) when he was about 4 years old. (Actually, ROSELLI was several years older than 4 when the picture was taken. This picture and a picture of his mother were left at his apartment house.) The picture of ROSELLI was actually a picture of PHILIP SACCO obtained from school records in Boston. ~~XS~~(u)

The admission made by ROSELLI to Colonel EDWARDS would greatly assist in proving ROSELLI's identity as PHILIP SACCO. The Washington Field Office is being requested to interview Colonel EDWARDS, who stated he would be willing to be interviewed by representatives of the Bureau to obtain full details of his contact with ROSELLI. ~~XS~~(u)

In addition to interviewing EDWARDS with regard to the admission made by ROSELLI to him, it is also suggested that Colonel EDWARDS be requested to telephonically contact ROSELLI following such interview, informing him of the contact by FBI Agents. This course of action is suggested because, as reported above, ROSELLI is extremely nervous as a result of FBI inquiries into his true identity and this contact might serve as the vehicle which could bring about ROSELLI's cooperation with an aim toward his development as an informant.

If this course of action is followed, it is suggested that in addition to EDWARDS prompt call to ROSELLI, he could at the time of the call report to interviewing Agents the reaction of ROSELLI which would also serve to advise the FBI that such call had been made. Washington Field should, thereafter, telephonically or by teletype, advise Los Angeles that the call was made and ROSELLI's reaction as reported by EDWARDS. Again, to carry this further, Los Angeles would, thereafter, make immediate contact with ROSELLI in Los Angeles, which would give this office an opportunity to develop him as an informant while he is still psychologically affected. For Washington Field's information, ROSELLI can be telephonically contacted through

LA 92-113

Los Angeles Telephone No. 474-4526, which number is listed to the Glen Towers, 1333 South Beverly Glen, Los Angeles, where ROSELLI resides.

To facilitate the interview of EDWARDS, there is enclosed herewith a copy of Bureau airtel to Los Angeles dated 5/24/66, and a confidential memo dated 5/18/66, which was sent to the Bureau by CIA setting forth Colonel EDWARDS' conversation with ROSELLI. ~~(S)~~(u)

2 That immediate legal action be taken or considered to expand ROSELLI's alien status by calling logical witnesses before a Federal Grand Jury, Los Angeles, California. u

It is noted that recently, AUSA RICHARD COLEMAN, Chief of the Organized Crime Division, Los Angeles, California was presented with a hypothetical case using the basic facts of the ROSELLI matter. AUSA COLEMAN indicated interest and stated he would bring a matter such as this before a Los Angeles Grand Jury. u

It is noted that a special Grand Jury is currently in session in Los Angeles inquiring into organized crime, which Grand Jury will be in session through January, 1967. Using this course of action, the Los Angeles Office would, in early January, advise the U. S. Attorney of the facts in the ROSELLI matter and, if agreeable with the U. S. Attorney, witnesses such as ROSELLI's friends, acquaintances, associates, and relatives, which could include a number of high ranking LCN members from Los Angeles, Chicago, New York and Boston, would be subpoenaed to appear. It was COLEMAN's opinion that while the Grand Jury could not indict ROSELLI for covering his alien status, the Federal Grand Jury would be effective in obtaining witnesses' statements under oath to be used in a future INS hearing and at the same time, afford the Government an opportunity to consider perjury on any witness who made perjurious statements. His main interest, however, is the disruptive tactics this course of action would have against organized criminals such as the known associates of the man described in the hypothetical case. u

LA 92-113

b7c To facilitate this plan of approach, it is requested that the Bureau, through Legat Rome, recontact [REDACTED] ask him if he would consent to appear as a witness in Los Angeles, California to testify on statements furnished by him on ROSELLI's true identity, or if he would furnish a deposition of the material information he has provided concerning ROSELLI's identity. Legat Rome is also being requested to obtain exemplified copies of the birth certificates of FILIPPO SACCO, MARIA SACCO and VINCENZO SACCO. It is noted that in the past copies of these certificates have been obtained and forwarded to Los Angeles, however, they were not exemplified copies. u

b7c To facilitate the leads for Legat Rome, there are enclosed herewith for the Bureau an original and five copies of a letterhead memorandum [REDACTED] u

It is requested that the leads for Legat and Washington Field, if Bureau approved, be expeditiously handled to facilitate the possibility of utilization of information in January, 1967, before a Federal Grand Jury, Los Angeles, as outlined above. u

Copies of this communication are being furnished to both Miami and Boston, based on outstanding leads in their respective divisions. Leads in this matter should also be completed by these offices and forwarded to Los Angeles expeditiously, bearing in mind the possibility of a January target date. u

For the information of the Bureau, reference is made to the Bureau airtel to Los Angeles dated 5/24/66, which enclosed the CIA memo of 5/18/66. In the CIA memo, it was requested by this agency that ROSELLI not be informed that CIA had disseminated his contact with EDWARDS prior to contact with their agency for consideration of any implications it would cause CIA. ~~TS~~ (u)

As pointed out above in this communication, the statement ROSELLI made to former CIA employee EDWARDS that

LA 92-113

the photograph shown to him was a picture of him as a child is of extreme pertinence to establishing proof of the dual role ROSELLI has played. If at all possible, it is desired that EDWARDS be permitted to testify to this. Therefore, the Bureau is requested through liaison to apprise CIA of our desired action and obtain from them a clearance to subpoena and utilize Colonel EDWARDS in a future Federal Grand Jury or INS hearing. ~~XS~~ (u)

~~TOP SECRET~~

12/7/66

Airtel

- 1 - Mr. DeLoach
- 1 - Mr. Sullivan
- 1 - Mr. Gale
- 1 - Mr. McAndrews *FOIPA # 22,33*
- 1 - Mr. Rutland

To: SAC, Los Angeles (92-113)

DECLASSIFIED BY *SP4-jm/kan*
ON *3/4/81*

From: Director, FBI (92-3267) *CIA Info declassified per John E. Bacon 8/27/80*

JOHN ROSELLI
ANTI-RACKETEERING

~~TOP SECRET~~

Classified by *6049*
Exempt from automatic downgrading and declassification
11/23/77

Reurairtel dated 11/18/66. *u*

A review of your proposal concerning future action in the Roselli matter has been made and the following instructions are being furnished for your future action.

Washington Field is not being instructed to interview Colonel Sheffield Edwards at this time as it is felt undesirable to draw CIA into this situation.

Los Angeles should immediately contact the United States Attorney's office in Los Angeles and proceed with the proposed grand jury inquiry into Roselli's alien status. It is felt that the potential for possible prosecution both to Roselli and to his hoodlum associates is the more desirable goal. *u*

Regarding Colonel Edwards, prior to any discussion with the United States Attorney's office concerning Edwards' possible appearance before the grand jury, the Bureau should be informed so that CIA can be advised in accordance with their request. Los Angeles should note that when CIA furnished

- 1 - Boston (92-458) (For info)
- 1 - Chicago (92-399) (For info)
- 1 - Miami (92-517) (For info)
- 1 - New York (92-721) (For info) *15*
- 1 - Washington Field (92-715) (For info)

DEC 8 1966

NOTE: See memorandum J. H. Gale to DeLoach, same caption, *12-6-66*
~~same~~ MER:skh.

MER:skh
(13) *skh*

APPROPRIATE AGENCIES AND FIELD OFFICES ADVISED BY ROUTING SLIP(S) *3-25-71*

MAILED 5
DEC 7 1966
COMM-FBI

- Tolson _____
- DeLoach _____
- Mohr _____
- Wick _____
- Casper _____
- Callahan _____
- Conrad _____
- Felt _____
- Gale _____
- Rosen _____
- Sullivan _____
- Tavel _____
- Trotter _____
- Tele. Room _____

DEC 14 1966 MAIL ROOM TELETYPE UNIT

DEC 7 1 36 PM '66
REC'D - READING ROOM

~~TOP SECRET~~

Airtel to Los Angeles
Re: John Roselli

the original information concerning Roselli's contact with Edwards they requested that prior to this information being disseminated that their agency be advised of any action in that regard. ~~S~~(U)

b7C
b7D

Concerning [REDACTED]

[REDACTED] It is felt that because of the jeopardy in which his life would be placed, that he should be only called before the grand jury as a last resort. Your request to have exemplified copies of birth certificates for Roselli and other members of his family has been forwarded. U

~~TOP SECRET~~

UNITED STATES GOVERNMENT

Memorandum

- Tolson _____
- DeLoach _____
- Mohr _____
- Wick _____
- Casper _____
- Callahan _____
- Conrad _____
- Felt _____
- Gale _____
- Rosen _____
- Sullivan _____
- Tavel _____
- Trotter _____
- Tele. Room _____
- Holmes _____
- Gandy _____

701pa# 22,330

TO : Mr. DeLoach *DL*

DECLASSIFIED BY *SP4-9m/k* DATE: 12/6/66
ON *3/4/81*

FROM : J. H. Gale *JHG*

*CIA info declassified per
John E. Bacon 8/27/50*

SUBJECT: JOHN ROSELLI
ANTI-RACKETEERING

Classified by *6049*

Exempt from automatic
downgrading and
declassification

~~TOP SECRET~~

Investigation has revealed that Roselli, a powerful La Cosa Nostra member residing in Los Angeles, California, who represents Chicago hoodlum hidden interests in Las Vegas casinos, has for many years carefully concealed his true identity as Filippo Sacco and his Italian birth. It is believed the purpose for assuming the alias of Roselli in 1922, was to conceal his identity following the commission of a serious crime and/or to hide his alien background. *u*

While our intensive investigation failed to uncover any prosecutable crime committed by Roselli, it has provided irrefutable evidence of his alien status which information was utilized by the Los Angeles Office to contact Roselli as a target under the Top Echelon Criminal Informant Program. To date, Roselli has failed to cooperate with us, however, it is known that he is extremely apprehensive concerning the information in the Bureau's possession and has indicated to associates that he fears he might be deported. *u*

In this regard, Roselli has been in contact with one Colonel Sheffield Edwards, a retired CIA official with whom Roselli has had previous dealings. During this contact, which Edwards reported to his successor at CIA, Roselli admitted his identity as Sacco. *u*

Los Angeles has proposed two future courses of action in regard to Roselli. The first is to have Bureau Agents interview Edwards regarding Roselli's admissions. Following his interview they would request Edwards to call Roselli and advise him of the FBI inquiry. Los Angeles' thinking here is that in view of Roselli's apprehensiveness over this situation, such an interview might have the effect of bringing about Roselli's cooperation.

Enc. *12-7-66*
1 - Mr. DeLoach
1 - Mr. Sullivan
1 - Mr. Gale

REC-50

~~TOP SECRET~~

EX-104

MCT-20

1 - Mr. McAndrews
1 - Mr. Rutland

CONTINUED - OVER

92
3242-730

55 DEC 15 1966

(6)

11 DEC 8 1966

Memorandum to Mr. DeLoach
Re: John Roselli

The second course of action is to commence legal action by calling local witnesses before a grand jury to expand on Roselli's alien status. In this regard, a set of hypothetical facts similar to those surrounding the Roselli situation have been presented to the Assistant United States Attorney in charge of the Organized Crime Section in Los Angeles who has indicated a desire to proceed on such a case. He had advised that while no indictment could be returned against Roselli based on his alien status, testimony received during such hearings could be utilized at a later date in immigration hearings and further that any statements made by friends, relatives and associates before such a grand jury could be the basis for perjury charges at some later date. In addition, it is felt such action would have an extremely disruptive effect on Roselli's hoodlum associates, many of whom would be called to testify before such a jury. u

It is felt that Los Angeles should be instructed to proceed along the lines of the second course of action. Concerning Edwards, it is not felt desirable to have the CIA drawn into this matter which would necessarily be the case should Edwards be called upon to provide any service other than to restate the details of his contact with Roselli. Edwards could and should be called as a logical witness before the proposed grand jury after CIA notified.

The second course of action, of course, provides us with the desirable goal of possible prosecutive action emanating from the grand jury against not only Roselli, but additionally, certain of his hoodlum associates. u

ACTION:

That the attached airtel setting forth the Bureau's observations and instructions be approved and forwarded. u

TOP SECRET

GRH *Walt* *MSR* *JLH* *do* *MSR* *AKS*

FBI

Date: 12/13/66 7018A# 22,330

RA

Transmit the following in _____

(Type in plaintext or code) ON _____

DECLASSIFIED BY Sgt. Jim/Kee

3/4/81

Via AIRTEL

AIR MAIL - REGISTERED

(Priority)

CIA Info declassified per John E. Bacon 8/67

~~TOP SECRET~~

TO: DIRECTOR, FBI (92-3267)
FROM: SAC, LOS ANGELES (92-113)
RE: JOHN ROSELLI, aka
AR
OO: LOS ANGELES

Classified by 6049
Exempt from GPO, Category 2
Date of Declassification Indefinite
PE/COB
11/29/77

Re Los Angeles airtel to Bureau dated 11/18/66, and Bureau airtel to Los Angeles dated 12/7/66.

As the Bureau has been previously advised, to date, persons have been interviewed who have admitted knowledge that JOHN ROSELLI is identical with PHILIP SACCO.

Other than [redacted] Colonel SHEFFIELD EDWARDS, the former Director of Security, CIA, who presently heads the firm Sheffield Edwards Associates, 1815 H Street, N.W., Washington, D.C., is the only person who has admitted having information concerning ROSELLI's true identity in that ROSELLI stated to him that FBI Agents gave ROSELLI a photograph of himself when he was a young boy and the photograph referred to was that of PHILIP SACCO. The Bureau's knowledge concerning this is based only on information furnished to the Bureau by CIA relative to Colonel EDWARDS' conversation with ROSELLI in May, 1966. Bureau Agents have never interviewed Colonel EDWARDS concerning his conversation with ROSELLI.

APPROPRIATE AGENCIES AND FIELD OFFICES ADVISED BY ROUTING SLIP(S) OF DECLASSIFIED DATE 3/25/81 ST

b2
b7D
TOP SECRET

- 3 - Bureau
 - 2 - Boston (92-458)(AM-RM)
 - 2 - Washington Field (92-715)(AM-RM)
 - 2 - Los Angeles
- HFD/mjg
(9)

X-104

REC-8 92-3267-731

1-3-67
10 DEC 15 1966

Approved: _____

Special Agent in Charge

Sent _____

M

Per _____

LA 92-113

~~TOP SECRET~~

The Los Angeles Office is firmly of the opinion that when the ROSELLI matter is discussed with the U. S. Attorney in Los Angeles this Office should be in a position to be able to furnish Colonel EDWARDS' name as a witness available to testify. As stated above, he would be the only witness the Bureau can name who has admitted having knowledge of ROSELLI's identity. If the members of ROSELLI's family do not admit knowledge of ROSELLI's identity before a Federal Grand Jury then without Colonel EDWARDS' testimony, it is doubtful that ROSELLI's true identity could be shown. If this cannot be shown then it follows that the birth certificate of PHILIP SACCO from Italy could not be used.

Therefore, it is requested that the Bureau authorize the Washington Field Office to interview Colonel EDWARDS and that the Bureau contact CIA to obtain clearance for Colonel EDWARDS to testify before a Federal Grand Jury. In making this request, the Los Angeles Office understands that Colonel EDWARDS should only be interviewed re his conversation with ROSELLI in May, 1966, and that no request should be made of him to advise ROSELLI and then the Bureau of the interview as set out in referenced Los Angeles airtel to the Bureau of 11/18/66.

The Boston Office has been requested to endeavor to locate and interview several relatives of ROSELLI, including cousins and aunts, as well as CATERINA PALAZZO, who, according to INS records, accompanied ROSELLI and his mother on their entrance into the U. S. in 1911. PALAZZO, if located, could be an excellent witness in this matter.

~~TOP SECRET~~
The Boston Office was also requested to endeavor to locate a photograph of VINCENT SACCO, brother of ROSELLI, who died in Boston in 1936. This photograph is of importance, inasmuch as, it could be shown to persons in Los Angeles who were acquainted with VINCENT SACCO in Los Angeles where he used the name JIMMY ROSELLI and who knew him as ROSELLI's brother. U

The results of the investigation pending in the Boston Office should be completed and made available to the Los Angeles Office prior to presenting this case to the U. S. Attorney. The Boston Office is requested to expeditiously complete the above investigation and submit the results to the Los Angeles Office by the first week of January, 1967. U

12/13/66

AIRTEL

AIR MAIL - REGISTERED

TO: DIRECTOR, FBI (92-3267)
FROM: SAC, LOS ANGELES (92-113)
RE: JOHN ROSELLI, aka
AR
OO: LOS ANGELES

Re Los Angeles airtel to Bureau dated 11/18/66,
and Bureau airtel to Los Angeles dated 12/7/66.

As the Bureau has been previously advised, to date,
persons have been interviewed who have admitted
knowledge that JOHN ROSELLI is identical with PHILIP SACCO,
[REDACTED]

Other than [REDACTED] Colonel SHEFFIELD EDWARDS,
the former Director of Security, CIA, who presently heads
the firm Sheffield Edwards Associates, 1815 H Street, N.W.,
Washington, D.C., is the only person who has admitted
having information concerning ROSELLI's true identity in that
ROSELLI stated to him that FBI Agents gave ROSELLI a
photograph of himself when he was a young boy and the
photograph referred to was that of PHILIP SACCO. The Bureau's
knowledge concerning this is based only on information
furnished to the Bureau by CIA relative to Colonel EDWARDS'
conversation with ROSELLI in May, 1966. Bureau Agents have
never interviewed Colonel EDWARDS concerning his conversation
with ROSELLI.

3 - Bureau
2 - Boston (92-458)(AM-RM)
2 - Washington Field (92-715)(AM-RM)
2 - Los Angeles
HFD/mjg
(9)

DECLASSIFIED BY SP4 Jmm/K
ON 3/4/81

CIA Info declassified per
John E. Bacon 8/27/80

LA 92-113

The Los Angeles Office is firmly of the opinion that when the ROSELLI matter is discussed with the U. S. Attorney in Los Angeles this Office should be in a position to be able to furnish Colonel EDWARDS' name as a witness available to testify. As stated above, he would be the only witness the Bureau can name who has admitted having knowledge of ROSELLI's identity. If the members of ROSELLI's family do not admit knowledge of ROSELLI's identity before a Federal Grand Jury then without Colonel EDWARDS' testimony, it is doubtful that ROSELLI's true identity could be shown. If this cannot be shown then it follows that the birth certificate of PHILIP SACCO from Italy could not be used.

Therefore, it is requested that the Bureau authorize the Washington Field Office to interview Colonel EDWARDS and that the Bureau contact CIA to obtain clearance for Colonel EDWARDS to testify before a Federal Grand Jury. In making this request, the Los Angeles Office understands that Colonel EDWARDS should only be interviewed re his conversation with ROSELLI in May, 1966, and that no request should be made of him to advise ROSELLI and then the Bureau of the interview as set out in referenced Los Angeles airtel to the Bureau of 11/18/66.

The Boston Office has been requested to endeavor to locate and interview several relatives of ROSELLI, including cousins and aunts, as well as CATERINA PALAZZO, who, according to INS records, accompanied ROSELLI and his mother on their entrance into the U. S. in 1911. PALAZZO, if located, could be an excellent witness in this matter.

The Boston Office was also requested to endeavor to locate a photograph of VINCENT SACCO, brother of ROSELLI, who died in Boston in 1936. This photograph is of importance, inasmuch as, it could be shown to persons in Los Angeles who were acquainted with VINCENT SACCO in Los Angeles where he used the name JIMMY ROSELLI and who knew him as ROSELLI's brother.

The results of the investigation pending in the Boston Office should be completed and made available to the Los Angeles Office prior to presenting this case to the U. S. Attorney. The Boston Office is requested to expeditiously complete the above investigation and submit the results to the Los Angeles Office by the first week of January, 1967.

KA

701PA# 20,330

12/28/66

DECLASSIFIED BY SPL- Jim/K
ON 3/4/81

Airtel

CIA Info Declassed per
John E. Bacon 8/27/80

Classified by 10049
Exempt from GDS, Category 2
Date of Declassification Indefinite
11/29/81
OC/ab
~~TOP SECRET~~

To: SAC, Los Angeles (92-113)
From: Director, FBI (92-3267) - 731

JOHN ROSELLI
AR

APPROPRIATE AGENCIES
AND FIELD OFFICES
ADVISED BY SLIP(S) OF
DATE 3-25-81-574

Re Los Angeles airtel to Bureau 12/13/66. u

The Roselli situation has been discussed with officials of CIA who have requested that the Bureau reconsider calling Colonel Sheffield Edwards to testify before a grand jury concerning his meeting with Roselli. CIA advises that any such appearance by Edwards would immediately "open the door" to public exposure of an extremely sensitive intelligence operation. CIA officials admit that Roselli has that Agency in an unusually vulnerable position.

In view of the foregoing, Los Angeles is instructed to resubmit a letterhead memorandum for the b7c to determine if he would consent to appear as a witness in Los Angeles to testify concerning Roselli's true identity or, in lieu of his appearance, furnish a deposition containing this information. u

MAILED 12
DEC 29 1966
COMM-FBI

1 - Washington Field

NOTE: LA is preparing to hold a grand jury inquiry into the true identity of John Roselli, noted hoodlum with LV and CG associates. Investigation has revealed Roselli actually born Filippo Sacco. Reason for change of name unknown. To date b7c individuals have been located who can testify to Roselli's true identity, those being b7c

b7c and Edwards of CIA. However, Edwards was Roselli's contact when CIA employed Sam Giancana, CG hoodlum, b7c b7c CIA requests that Edwards not be called to appear of embarrassment to that Agency. LA instructed to attempt to b7c appear before FGJ. AS

MER:bjn/nlk
(5)

- Tolson _____
- DeLoach _____
- Mohr _____
- Wick _____
- Casper _____
- Callahan _____
- Conrad _____
- Felt _____
- Gale _____
- Rosen _____
- Sullivan _____
- Tavel _____
- Trotter _____
- Tele. Room _____
- Holmes _____
- Gandy _____

MAIL ROOM TELETYPE UNIT

62 JAN 1 1967

AS
mm

UNITED STATES GOVERNMENT

Memorandum

- Tolson _____
- DeLoach _____
- Mohr _____
- Wick _____
- Casper _____
- Callahan _____
- Conrad _____
- Felt _____
- Gale _____
- Rosen _____
- Sullivan _____
- Tavel _____
- Trotter _____
- Tele. Room _____
- Holmes _____
- Gandy _____

TO : Mr. D. J. Brennan *[Signature]*

FROM : S. J. Papich *[Signature]*

SUBJECT: JOHN ROSELLI
AR

DATE: 12/22/66

1 - Mr. Rutland
1 - Liaison
1 - Mr. Papich

~~TOP SECRET~~

McAndrew
[Handwritten initials]

Reference is made to memo from Mr. Gale to Mr. DeLoach dated December 12, 1966, and to Los Angeles airtel dated December 13, 1966.

On December 19, 1966, the Liaison Agent met with Howard J. Osborn, Director of Security, Central Intelligence Agency (CIA), and briefly reviewed the meeting which Colonel Sheffield Edwards, former CIA Director of Security, held with the subject on May 12, 1966, as previously reported. Roselli told Edwards that the FBI had left an envelope at his apartment, and this envelope contained a photograph of the subject when he was a child. Osborn was told that consideration was being given to initiating legal action against Roselli by calling witnesses who could furnish information bearing on Roselli's alien status. The Liaison Agent asked if CIA would support such action. This question was posed since Edwards relationship with the subject was associated with a sensitive CIA intelligence operation.

~~TOP SECRET~~

Osborn advised that CIA could not permit Edwards to testify before a grand jury or any kind of judicial hearing regarding the meeting of May 12, 1966, or concerning any other phases of Edwards relationship with Roselli. Osborn stated that in the opinion of CIA any such appearance by Edwards would immediately "open the door" to public exposure of an extremely sensitive intelligence operation: that it is CIA's belief that there can be no real assurance that testimony would not leak; and that revelation of the intelligence operation would prove highly embarrassing to the United States Government. Osborn advised that CIA is of the strong opinion that if Edwards ever testified the subject would not hesitate to expose the intelligence operation. Osborn freely admitted that Roselli has CIA in an unusually vulnerable position.

Classified by *Ced/49*
Exempt from GDS, Category *2*
Date of Declassification Indefinite

DECLASSIFIED BY *SP4 JJA/ta*
ON *3/14/81*
CIA Info Released Per
John E. Bacon 8/27/80

SJP:dag

REC-8

92-3267-732

62 JAN 19 1967

EX-104

CONTINUED OVER
5 JAN 3 1967

5-000
[Handwritten signatures and initials]

Memorandum to Mr. Brennan
Re: John Roselli

Osborn stated that CIA was also thinking of Edwards personal safety. He expressed concern that the subject and his associates no doubt have the capability to strike at Edwards.

In connection with the aforementioned meeting of May 12, 1966, Osborn wanted to highlight the fact that the subject never revealed to Edwards that his true name is Philip Sacco. According to Osborn, the subject did make it quite clear that he was having difficulty with the FBI, and he did refer to a photograph but did not volunteer any information regarding another identity. Osborn commented that in the opinion of CIA, subject very likely made the contact with Edwards on the assumption that Edwards would inform the FBI.

Osborn asked that his information be held within the Bureau on a strictly need-to-know basis, and requested that he be advised if the Bureau insists on Edwards testifying before a grand jury or at any other type of judicial hearing. He stated that Edwards was instructed long ago not to discuss any aspect of this matter with anyone without first consulting with CIA Headquarters.

Osborn recognized that CIA has a duty to furnish all necessary cooperation, and he did not discount the possibility that CIA relationship with Roselli could be explored to possible advantage. He stated that if the Bureau has any ideas or plans apart from Edwards testimony the Agency will be glad to confer with us.

OBSERVATION:

~~TOP SECRET~~

Roselli seems to have CIA in a "box." CIA, which has been the target of heavy Press attack, very definitely has the jitters and will do everything possible to avoid potential embarrassment. CIA is assuming that Roselli has no qualms about embarrassing CIA if it serves his interests. Roselli appears to have a powerful weapon by merely threatening to expose the sensitive operation.

CONTINUED-OVER

Memorandum to Mr. Brennan
Re: John Roselli

ACTION:

The above information is being directed to the attention of the Criminal Intelligence Unit of the Special Investigative Division. If we decide to go into this any further with CIA, it is suggested that the matter be handled via Liaison.

[Handwritten signatures]

~~TOP SECRET~~

FEDERAL BUREAU OF INVESTIGATION

REPORTING OFFICE LOS ANGELES	OFFICE OF ORIGIN LOS ANGELES	DATE MAR 15 1967	INVESTIGATIVE PERIOD 2/6/67 - 3/7/67
TITLE OF CASE CHANGED JOHN ROSELLI, aka Filippo Sacco (TN), Fillippo Sacco, Filipo Sacco, Philippo Sacco, Phillippo Sacco, Phillippo Sacco, Philip Sacco		REPORT MADE BY SA [REDACTED]	TYPED BY 11E
		CHARACTER OF CASE AR	

~~TOP SECRET~~

The title of this case has been marked changed to add subject's true name of **FILIPPO SACCO** and to add the additional aliases of **Fillippo Sacco, Filipo Sacco, Philippo Sacco, Phillippo Sacco, Phillip Sacco, and Philip Sacco** based on information set out in this report.

REFERENCE: Report of [REDACTED] dated 1/31/67 at Los Angeles.

DECLASSIFIED BY 94-Jrm/Koa
ON 3/4/81 70EPA# 22, 330

- P -

Classified by 6049
Exempt from GDS, Category 2
Date of Declassification Indefinite

ENCLOSURE CIA Info declassified per
John E. Bacon 8/27/80
FOR BUREAU

Two (2) copies of a letterhead memorandum setting forth characterization of informants used in this report.

Case has been: Pending over one year Yes No; Pending prosecution over six months Yes No

REC-7

APPROVED: [Signature] SPECIAL AGENT IN CHARGE

COPIES MADE: [Signature] See Cover Page B

*1cc to Headquarter
INS 8-14-67*

DO NOT WRITE IN SPACES BELOW

92-3267-75/MCT-27

3 MAR 16 1967

Dissemination Record of Attached Report	
Agency	CC. AAG, Criminal Division,
Request Recd.	
Date Fwd.	Organized Crime and Racketeering
How Fwd.	
By	5 [Signature] Room 9572

~~TOP SECRET~~
Notations

TOP SECRET

for card

~~TOP SECRET~~

b7C On 5/26/66 Attorney JAMES CANTILLON telephonically contacted SA [REDACTED] and stated that he had had a long talk with JOHN ROSSELLI and that ROSSELLI will not meet Agents on 5/27/66. CANTILLON then said, "So we'll be seeing you, I guess." u

On 5/17/66 during the conversation with CANTILLON he advised that on Tuesday afternoon, 5/10/66, he and ROSSELLI left Los Angeles by airplane for New York City and that CANTILLON returned on 5/12/66 and ROSSELLI returned on 5/13/66. CANTILLON did not state the reason for this trip. However, it is known that on 5/12/66 ROSSELLI contacted Colonel SHEFFIELD EDWARDS, former Director of Security of Central Intelligence Agency in Washington, D.C., and related to him the fact that he had been contacted by FBI Agents. He told Colonel EDWARDS that the FBI Agents left at his apartment a picture of a woman and of a child about four years old. He told Colonel EDWARDS that the child was himself at that age. Colonel EDWARDS tried to get more details concerning the woman but ROSSELLI was, according to Colonel EDWARDS, very touchy on this. X (u)

By airtel dated 12/28/65 the Bureau advised that Central Intelligence Agency feels that an appearance by Colonel EDWARDS as a witness would "open the door" to probable exposure of an extremely sensitive intelligence operation and that Central Intelligence Agency officials admit that ROSSELLI has that agency in an unusually vulnerable position.

It is noted that after the original approach to ROSSELLI on 5/5/66 a picture of ROSSELLI's mother and a picture of himself as a young boy in grade school were placed in an envelope and left at ROSSELLI's apartment. u

It is further noted that on 5/10/66, the day ROSSELLI and CANTILLON proceeded to New York City, [REDACTED]

b7D
OS [REDACTED] law firm of Vincent V. Welch and Edward P. Morgan, Washington, D.C. EDWARD P. MORGAN is a former inspector of the FBI. u

~~TOP SECRET~~

UNITED STATES GOVERNMENT

Memorandum

TO : Mr. W. C. Sullivan *W.C.S.*

- 1 - Mr. DeLoach
- 1 - Mr. Rosen

- Tolson
- DeLoach
- Mohr
- Wick
- Casper
- Callahan
- Conrad
- Felt
- Gale
- Rosen
- Sullivan
- Tavel
- Trotter
- Tele. Room
- Holmes
- Gandy

DATE: 5/4/67

FROM : D. J. Brennan, Jr. *D.J.B.*

- 1 - Mr. Gale
- 1 - Mr. Sullivan
- 1 - Mr. McAndrews
- 1 - Liaison
- 1 - Mr. Papich

SUBJECT: JOHN ROSELLI
ANTI-RACKETEERING

The subject is a member of the Chicago "family" of La Cosa Nostra, who has represented their interests in Las Vegas and on the west coast. We previously have received information concerning past contacts between Roselli and representatives of Central Intelligence Agency (CIA). This was an association which developed in connection with CIA's abortive plan to assassinate Fidel Castro. After CIA's involvement was embarrassingly exposed, the Agency allegedly discontinued any operational relationship with Roselli.

On 5/3/67, [redacted] Inspector General, CIA, advised the Liaison Agent that on 5/2/67 William Harvey of CIA received a telephone call from Roselli, who was on the west coast, at which time the subject stated that he was coming to Washington in the near future and that he would be in contact with Harvey. He furnished no further details. [redacted] advised that CIA has instructed Harvey to avoid contact with subject if possible. CIA realizes that Roselli may force a contact and it will be impossible for Harvey to evade the subject. [redacted] has advised that if contact is made Harvey is to furnish the results which will be passed on to the Bureau.

For your information, Harvey, former Bureau Agent, is currently on Sick Leave. At the termination of this leave, he goes into retirement. He, therefore, is essentially separated from Agency employment. He did have contacts with Roselli during some of the period that the Agency was involved with the subject.

As previously pointed out, CIA is in an extremely vulnerable position. Roselli and associates

ALL INFORMATION CONTAINED
 HEREIN IS UNCLASSIFIED
 DATE 3/5/81 BY SP4-jym/kaa
 CIA info unclass
 Per John E. Bacon
 8/27/80
 #22,330

J

D.C.
b3
per
CIA

Handwritten: KEROX
SJP MAY 15 1967
(8)

REC-8

92-3267-759

CONTINUED-OVER 1 copies made

57 MAY 18 1967

MAY 8 1967

2/1/78 DJC
K. Harre
at FBIHQ
re 1/10/78 req
See Bufile #32-117

PERC REC 10/11

Memorandum D. J. Brennan, Jr. to W. C. Sullivan
RE: JOHN ROSELLI
ANTI-RACKETEERING

U.S.A.

such as Sam ~~X~~Giancanna continue to be in a position to publicly embarrass CIA.

ACTION:

For your information. The Liaison Agent will follow with ~~_____~~ in order to obtain the results of any contact which subject may have with Harvey.

*b3
Per
CIA*

[Handwritten signature]

McCoy

[Handwritten initials]

As

UNITED STATES GOVERNMENT

Memorandum

TO : Mr. W. C. Sullivan

FROM : D. J. Brennan, Jr. *95*

SUBJECT: JOHN ROSELLI
ANTI-RACKETEERING

1 - Mr. DeLoach
1 - Mr. Rosen
1 - Mr. Gale
DATE: 5/12/67

1 - Mr. McAndrews
1 - Mr. Sullivan
1 - Mr. Branigan
1 - Liaison
1 - Mr. Papich

Tolson	_____
DeLoach	_____
Mohr	_____
Wick	_____
Casper	_____
Callahan	_____
Conrad	_____
Felt	_____
Gale	_____
Rosen	_____
Sullivan	_____
Tavel	_____
Trotter	_____
Tele. Room	_____
Holmes	_____
Gandy	_____

On 5/11/67, William Harvey, Central Intelligence Agency (CIA), telephonically advised Special Agent Papich that he had received a telephone call from the subject about 10:00 a.m., 5/11/67. Roselli stated that he was in town and that he would like to meet with Harvey on the evening of 5/11/67. Harvey advised that he would meet with Roselli and would subsequently furnish the results. Harvey was not certain but it was his opinion that Roselli was stopping at the Madison Hotel, which hotel he has used in the past.

On 5/12/67, Harvey advised that he had met with Roselli. He stated that Roselli was very friendly, did not bring up any new propositions or angles, and made it quite clear that he was just dropping by to "say hello." During the course of the conversation, Roselli commented that he had a new attorney, Ed Morgan. Harvey advised that he had some additional observations which might be of interest and he would pass these to Agent Papich as soon as possible. Harvey indicated that he would be out of town for three or four days and would then contact Papich. With regard to Morgan, Roselli apparently is referring to Ed Morgan, former Bureau Inspector. We already know that he has been dealing with Roselli and his associates.

Harvey stated that Roselli did not volunteer any information which might explain the purpose of his trip to Washington, D. C. The subject did indicate that he would continue to be in the city through 5/12/67. Harvey suggested the possibility that Roselli was in town in connection with the recent arrests of several individuals in Las Vegas who were involved in violation of Nevada State gambling laws.

SJP:rab
(9)

CONTINUED - OVER

ALL INFORMATION CONTAINED
HEREIN IS UNCLASSIFIED
DATE 3/5/81 BY SP4-jmk/ka

CIA info unclass per
John E. Bacon 8/27/80

#22,330

57 MAY 26 1967

MAY 25 1967

REC-75

EX-103

MAY 17 1967

PERS. REC. UNIT

FILE

DC

S

92-30776

Memorandum D. J. Brennan, Jr. to W. C. Sullivan
RE: JOHN ROSELLI
ANTI-RACKETEERING

ACTION:

As previously reported, Harvey fully understands that we are not requesting him to do anything in behalf of the Bureau. If approved, Agent Papich will continue to accept any information which Harvey may volunteer.

[Handwritten initials]

v

[Handwritten signature]

WCS/03

[Handwritten signature]
nm

[Handwritten initials]

UNITED STATES GOVERNMENT

Memorandum

TO : Mr. W. C. Sullivan

DATE: 5/8/67

FROM : D. J. Brennan, Jr. *DB*

- 1 - Mr. DeLoach
- 1 - Mr. Rosen
- 1 - Mr. Gale
- 1 - Mr. McAndrews
- 1 - Mr. Sullivan
- 1 - Mr. Branigan
- 1 - Liaison
- 1 - Mr. Papich

SUBJECT: JOHN ROSELLI
ANTI-RACKETEERING

- Tolson
- DeLoach
- Mohr
- Casper
- Callahan
- Conrad
- Felt
- Rosen
- Sullivan
- Tavel
- Trotter
- Tele. Room
- Holmes
- Gandy

Reference is made to my memorandum dated 5/4/67 indicating that the subject had telephonically contacted William Harvey, Central Intelligence Agency (CIA), stating that he was coming to Washington in the near future and that he would be in contact with Harvey. On 5/5/67, Harvey volunteered the following information to the Liaison Agent:

Harvey briefly reviewed his association with Roselli, stating that he first met him in the Spring of 1962 pursuant to instructions of his CIA superiors. Roselli already had established and maintained contact with CIA in connection with the plan directed against Castro. After CIA's operation was compromised in the Spring of 1961, CIA decided to cut off relations with Roselli and Sam Giancana but wanted to make certain that the severance was performed as smoothly as possible in order to avoid any adverse repercussions. Harvey inherited the assignment of the "phasing out" part of the operation in the Spring of 1962. His essential function was to neutralize any attempts by Giancana or Roselli to embarrass CIA. In 1963, Harvey was told to avoid any further contact with Roselli and he has not seen him since. During the past year he has received three or four telephone calls from the subject, at which time Roselli brought up no problems and apparently was interested in only engaging in general chit-chat. The last call was on Sunday, 4/30/67 (not on 5/2/67 as previously reported). The subject stated he was coming to Washington in the near future and wanted to see Harvey. He did not furnish any further details.

CIA Info unclass per John E. Bacon 8/27/80

ALL INFORMATION CONTAINED
HEREIN IS UNCLASSIFIED

DATE 3/5/81 BY SP4-9/m/kaa

SJP:rab
(9)

REC 13

EX-103

92-5267-762

MAY 19 1967

CONTINUED - OVER

WAF A

Levick N/A

79 MAY 22 1967

Memorandum D. J. Brennan, Jr. to W. C. Sullivan
RE: JOHN ROSELLI
ANTI-RACKETEERING

Harvey has learned that Roselli has occasion to confer with Robert Maheu but did not know the extent and the nature of the relationship between the two. Harvey stated that he personally has never been in contact with Giancana. He further commented that none of the stories coming out of the Garrison investigation in New Orleans in any way relate to the CIA operation which was directed against Castro.

With regard to the recent call, Harvey stated that he will not seek Roselli but if Roselli comes to Washington Harvey will meet with him if he is contacted. He feels that acting to the contrary will only bring troubles for CIA. He stated that if he meets with Roselli he will carefully listen to all information volunteered and will make certain that the data is transmitted to the Bureau.

The Liaison Agent made it very clear that the Bureau was not requesting Harvey to take any action. Harvey fully understands as does CIA that the Agency and its personnel such as Harvey will be responsible for the consequences of any association maintained with the subject.

ACTION:

For information.

AM
WCB I doubt if we will ever learn the full story on this - *WCB*
1/2
JK
JK
JK

I doubt if we will ever learn the full story on this.

D.
- 2 - I share some doubt because of "atinks".
4

UNITED STATES GOVERNMENT

Memorandum

Tolson	_____
DeLoach	_____
Mohr	_____
Wick	_____
Casper	_____
Callahan	_____
Conrad	_____
Felt	_____
Gale	_____
Rosen	_____
Sullivan	_____
Tavel	_____
Trotter	_____
Tele. Room	_____
Holmes	_____
Gandy	_____

TO : Mr. W. C. Sullivan

1 - Mr. DeLoach

1 - Mr. Rosen

DATE: 5/22/67

FROM : D. J. Brennan, Jr.

1 - Mr. Gale

1 - Mr. McAndrews
(Leggett)

SUBJECT: JOHN ROSELLI
ANTI-RACKETEERING

1 - Mr. Sullivan

1 - Mr. Branigan

1 - Liaison

1 - Mr. Papich

Reference is made to my memorandum to you dated 5/12/67. On 5/19/67, William Harvey, Central Intelligence Agency (CIA), volunteered the following additional information concerning the meeting he had with Roselli on 5/11/67:

Harvey met the subject on a downtown Washington street after receiving a telephone call from Roselli on 5/11/67. The subject never did identify the hotel where he was staying, but Harvey assumed it was the Madison Hotel. Subject did not discuss the purpose of his stop in Washington, D. C., and merely indicated that he was calling on Harvey to "say hello" and renew their association, bearing in mind that they had not seen each other since 1963. They had dinner at Harvey's residence.

Harvey made brief reference to information appearing in one of Drew Pearson's columns and to news stories coming out of New Orleans indicating that CIA may have been involved in some kind of a plot to assassinate Castro. Harvey expressed concern that there may have been a leak concerning the CIA operation. Roselli stated that he was not concerned about any of the publicity and he discounted the New Orleans stories as having any connection with his past activities.

The Liaison Agent asked Harvey for his opinion concerning the possibility of leaks stemming from people whom Roselli and Giancana may have been prepared to use in the CIA operation. Harvey commented that there was no reason to worry "about the Cubans." It is believed that this is the first information we have indicating that Roselli and Giancana planned to use Cubans in the operation. Harvey did not elaborate on this point.

SJP:rab
(9)

CONTINUED - OVER

54 JUN 7 1967

MAY 31 1967
copies made of file 763
10/1/78 DTC
re: W.K. Harvey
for review at FBIHQ by
HSCA re: 4/10/78 request.
(See Bufile #62-117290)

*Continue to maintain Special file
7007 per G.C. Kelly
6-30-67*

Memorandum D. J. Brennan, Jr. to W. C. Sullivan
RE: JOHN ROSELLI
ANTI-RACKETEERING

b6
per
CIA

Roselli made no mention of Giancana or this individual's present whereabouts. The subject talked in general about Hollywood and Las Vegas mentioning that he is very close to [redacted] and has occasion to confer with [redacted]. He spoke very contemptuously of [redacted] and Bobby Kennedy. He indicated that he was doing well financially, and he appears to be involved in the booking of acts and shows in Las Vegas.

He casually mentioned that the FBI was trying to prove he was not born in Chicago. He ridiculed the idea. He seems to be very self assured and confident.

b6
per
CIA

He gave no indication of being closely involved with any one woman at the present time. In past conversations, he indicated that he may have been romantically involved with [redacted] of Chicago. He has also mentioned that he had been closely associated with [redacted], whom he has referred to as [redacted] one of his old girlfriends at one time was [redacted]. It is Harvey's recollection that he referred to her as [redacted].

He briefly mentioned that Ed Morgan was serving as his lawyer but he did not elaborate. US.

It was Harvey's opinion that subject will never discuss his criminal activities. He has not done so in the past, and Harvey does not believe that his relationship is so close to influence subject to the contrary. Harvey made the observation that if he ever did ask any pointed question touching on this area, Roselli undoubtedly would reply "you should know better." Harvey has no plan to see the subject in the future but does not discount the possibility that Roselli could make a contact on his own initiative.

The Liaison Agent again reiterated that any involvement with the subject is strictly Harvey's responsibility and that he was on his own. Harvey stated that he fully realizes this and advised that he would furnish the Bureau the results of any meetings or contacts he might have with the subject.

ACTION: The above information is being directed to the attention of the Criminal Intelligence - West Unit of the Special Investigative Division.

Ⓟ ✓ W.C.S. [Signature]

8/17/67

DECLASSIFIED BY SP4-*gm/ka*
ON 3/5/81 *FDI # 22,330*

CIA Info Declassified per John E. Bacon 8/27/80

Airtel

To: SAC, Los Angeles

From: Director, FBI

JOHN ROSELLI, aka
ANTI-RACKETEERING

16049
Classified by *SP4-gm/ka*
Exempt from GDS, Category *2*
Date of Declassification Indefinite
11/29/80
1/27/89

Reurad 8/9/67. *U*

Central Intelligence Agency (CIA) officials were recontacted and the Roselli matter rediscussed as it pertains to the appearance of Colonel Sheffield Edwards as a witness before a Grand Jury sitting in Los Angeles. *XS(u)*

CIA officials reiterated their stand that the appearance of Colonel Edwards as a witness before any Grand Jury would involve the possibility of having to furnish information of such sensitivity that it could seriously jeopardize national security interests. *XS(u)*

In deference to CIA's desires on this matter, this information should not be furnished to Assistant United States Attorney Nissen so that he may attempt to proceed through the Department of Justice to obtain Edwards as a witness. Los Angeles should attempt to disprove Roselli's claim as to citizenship through the use of relatives and close friends. *AS*

~~NOTE: See page 2~~

APPROPRIATE AGENCIES
AND FIELD OFFICES
ADVISED BY SLIP(S)
Do. Nissen
3-28-67

~~TOP SECRET~~

REC-211

92-3267-767

16 AUG 18 1967

MAILED 19
AUG 17 1967
COMM-FBI

EX 105

- Tolson _____
- DeLoach _____
- Mohr _____
- Bishop _____
- Casper _____
- Callahan _____
- Conrad _____
- Felt _____
- Gale _____
- Rosen _____
- Sullivan _____
- Tavel _____
- Trotter _____
- Tele. Rm. _____
- Holmes _____
- Gandy _____

54 AUG 24 1967

MAIL ROOM TELETYPE UNIT

NA
8-9-67
ER

DECODED COPY

- Tolson _____
- DeLoach _____
- Mohr _____
- Bishop _____
- Casper _____
- Callahan _____
- Conrad _____
- Felt _____
- Gale _____
- Rosen _____
- Sullivan _____
- Tavel _____
- Trotter _____
- Tele. Room _____
- Holmes _____
- Gandy _____

AIRGRAM CABLEGRAM RADIO TELETYPE

DECLASSIFIED BY SP4-jm/kaa
ON 3/5/81 7024422,330 McAndrew

R-90
URGENT 8-9-67
TO DIRECTOR
FROM LOS ANGELES

*CIA info declassified per
John E. Bacon 8/27/80

JOHN ROSELLI, AKA. AR.

APPROPRIATE AGENCIES
AND FIELD OFFICES
ADVISED BY ROUTING
SLIP(S) OF DECLASSIFIED

DATE 3-25-81 SH

McAndrew
Baker
9-Ref
Paff
BAE

IN THE INVESTIGATION OF CASE ENTITLED "JOHN ROSELLI, AKA; ET AL. ITAR-GAMBLING," BUFILE 163200, INVOLVING CROOKED GAMBLING AT FRIARS CLUB, BEVERLY HILLS, AUSA DAVID NISSEN PLANS TO ISSUE SUBPOENA FOR ROSELLI'S APPEARANCE BEFORE FGJ AUGUST 17 NEXT. IT IS EXPECTED ROSELLI WILL "TAKE THE FIFTH" ON ALL QUESTIONS. NISSEN THEN PLANS TO HAVE INS REPRESENTATIVES INTERVIEW ROSELLI AS HE LEAVES FGJ AND ASK HIM HIS NAME AND DATE AND PLACE OF BIRTH. IF ROSELLI REFUSES TO ANSWER, NISSEN CLAIMS INS HAS AUTHORITY TO CONFINE ROSELLI UNTIL HE DOES ANSWER. IF ROSELLI CLAIMS BIRTH IN CHICAGO, ILLINOIS, NISSEN INTENDS TO ISSUE SUBPOENAS FOR ROSELLI'S RELATIVES AND OTHER WITNESSES FOR APPEARANCE BEFORE FGJ WITHIN IMMEDIATE FUTURE SEEKING AN

Classified by 6893
Exempt from GDS, Category 1
Date of Declassification Indefinite

56 AUG 28 1967

~~TOP SECRET~~ REC-75

92-3267-710

16 AUG 22 1967

If the intelligence contained in the above message is to be disseminated outside the Bureau, it is suggested that it be suitably paraphrased in order to protect the Bureau's cryptographic systems.

- Tolson _____
- DeLoach _____
- Mohr _____
- Bishop _____
- Casper _____
- Callahan _____
- Conrad _____
- Felt _____
- Gale _____
- Rosen _____
- Sullivan _____
- Tavel _____
- Trotter _____
- Tele. Room _____
- Holmes _____
- Gandy _____

DECODED COPY

AIRGRAM CABLEGRAM RADIO TELETYPE

PAGE TWO FROM LOS ANGELES

INDICTMENT AGAINST ROSELLI FOR FALSELY CLAIMING CITIZENSHIP. U

IN MAY, 1966 SEE BUREAU AIRTEL TO LOS ANGELES MAY 24, 1966
 ROSELLI CONTACTED COLONEL SHEFFIELD EDWARDS, FORMER DIRECTOR OF
 SECURITY, CIA, AND TOLD EDWARDS THAT FBI AGENTS, DURING INTER-
 VIEW IN MAY 1966, GAVE ROSELLI A PICTURE OF HIMSELF WHEN HE WAS
 ABOUT FOUR YEARS OLD. THIS WAS A PHOTOGRAPH OF PHILIP SACCO
 OBTAINED FROM BOSTON SCHOOL RECORDS. EDWARDS WOULD BE EXTREMELY
 VALUABLE WITNESS TO PROVE ROSELLI'S TRUE IDENTITY. ~~IS~~(u)

BUREAU AIRTEL TO LOS ANGELES DECEMBER 28 LAST REFLECTS
 CIA FELT APPEARANCE BY EDWARDS WOULD EXPOSE EXTREMELY SENSITIVE
 INTELLIGENCE OPERATION AND REQUESTED BUREAU RECONSIDER CALLING
 EDWARDS.

BUREAU REQUESTED TO RECONTACT CIA RE THEIR PRESENT ATTITUDE
 TO HAVING EDWARDS CALLED AS WITNESS. IF CIA STILL AGAINST SUCH
 APPEARANCE, LOS ANGELES REQUESTS BUREAU ADVISE WHETHER INFOR-
 MATION RE EDWARDS CAN BE FURNISHED AUSA NISSEN SO THAT NISSEN,
 IF HE DESIRES, CAN PROCEED THROUGH DEPARTMENT OF JUSTICE IN

EFFORT TO OBTAIN EDWARDS AS WITNESS.

~~TOP SECRET~~

RECEIVED: 6:01 PM JAH

~~TOP SECRET~~

SAC, Los Angeles (92-113)

8/23/67

Director, FBI (92-3267)

O
JOHN ROSELLI, aka
ANTI-RACKETEERING

~~TOP SECRET~~

In May of 1966, Los Angeles Agents furnished to Roselli an envelope which contained a picture of a woman and a child about four years of age. Shortly thereafter, Roselli, in a discussion with Colonel Sheffield Edwards, former Central Intelligence Agency official, identified the child as being himself at that age. *X(u)*

Los Angeles is requested to identify this photo. Advise if person actually Roselli, when taken, and where obtained. *u*

NOTE: Roselli, Los Angeles La Cosa Nostra figure, during contact in May of 1966, was given photograph by Bureau Agents. Photo was used to convince Roselli that Bureau aware of his true identity as Filippo Sacco and was in fact an alien illegal in this country. Los Angeles being requested to furnish information as to identity of persons in this photo and where same was obtained. *u*

APPROPRIATE AGENCIES
AND FIELD OFFICES
ADVISED BY ROUTING
SLIP(S) OF *Declassified*
3-20-11-54

MAILED 8
AUG 23 1967
COMM - FBI

REC 11 92-3267-771

~~TOP SECRET~~

EX 106

Classified by *6049*
Exempt from GDS, Category *2*
Date of Declassification Indefinite
11/29/77
of 108

AUG 24 1967

- Tolson _____
- DeLoach _____
- Mohr _____
- Bishop _____
- Casper _____
- Callahan _____
- Conrad _____
- Felt _____
- Gale _____
- Rosen _____
- Sullivan _____
- Tavel _____
- Trotter _____
- Tele. Room _____
- Holmes _____
- Gandy _____

MER:skh
(4) *skh*

DECLASSIFIED BY *SP4-jm/ker*
ON *3/5/81* *FOIPA # 22, 330*
** CIA Info declassified per Let*
John E. Bacon 8/27/80

57 AUG 28 1967

TELETYPE UNIT

UNITED STATES GOVERNMENT

Memorandum

Tolson	_____
DeLoach	_____
Mohr	_____
Bishop	_____
Casper	_____
Callahan	_____
Conrad	_____
Felt	_____
Gale	_____
Rosen	_____
Sullivan	_____
Tavel	_____
Trotter	_____
Tele. Room	_____
Holmes	_____
Gandy	_____

TO : Mr. D. J. Brennan, Jr. *[Signature]*

DATE: 9/19/67

FROM : S. J. Papich *[Signature]*

SUBJECT: JOHN ROSELLI
ANTI-RACKETEERING

[Handwritten initials: B.D.]
[Handwritten signature: M. Andrews]

William Harvey, former Central Intelligence Agency (CIA) employee, telephonically advised Agent Papich on 9/19/67 that he had received a telephone call from the subject on the evening of 9/18/67. Roselli indicated that he would be coming to Washington, D. C. within the next few days and wanted to see Harvey. He made brief reference to a Grand Jury which was meeting on the West Coast and expressed some concern about this development. He did not furnish any further details.

Harvey stated that if the subject contacts him he will arrange a meeting and will report the results to Agent Papich.

ACTION:

The above information is being directed to the attention of the Criminal Intelligence Unit of the Special Investigative Division. *[Handwritten mark: u]*

- 1 - Mr. McAndrews
- 1 - Liaison
- 1 - Mr. Papich

SJP:rab
(4) *[Handwritten initials]*

ALL INFORMATION CONTAINED
HEREIN IS UNCLASSIFIED
DATE 3/5/81 BY SP4-jmm/keu

* CIA Info unclassified per John E. Bacon 8/27/80

[Handwritten initials: B.D.]
[Handwritten signature]

REC 45

92 - 3267 - 836

EX 106

SEP 22 1967

NINE

57 SEP 28 1967

UNITED STATES GOVERNMENT

Memorandum

Tolson	_____
DeLoach	_____
Mohr	_____
Bishop	_____
Casper	_____
Callahan	_____
Conrad	_____
Felt	_____
Gale	_____
Rosen	_____
Sullivan	_____
Tavel	_____
Trotter	_____
Tele. Room	_____
Holmes	_____
Gandy	_____

TO : Mr. D. J. Brennan, Jr. *AM* DATE: 9/25/67

FROM : S. J. Papich *P*

**ALL INFORMATION CONTAINED
HEREIN IS UNCLASSIFIED** *70 IPA # 22,330*

SUBJECT: JOHN ROSELLI
ANTI-RACKETEERING

DATE 3/5/81 BY SP4-Jm/Kaa
**CIA info unclassified per John E. Bacon 8/27/80*

M'Andrews

William Harvey, former Central Intelligence Agency (CIA) employee, telephonically furnished the following information to SA Papich on 9/23/67.

The subject, calling from the West Coast, telephonically advised Harvey on the evening of 9/22/67 that his plans had been changed and that he would not be coming to Washington, D. C., in the near future. Roselli made brief reference to a "Grand Jury Session" and implied that there was no longer any reason to make a fast trip to Washington. He told Harvey that he would be in contact with him at some time in the future.

Agent Papich asked Harvey why Roselli called in the first place. Harvey replied that he could only conjecture. In his opinion Roselli apparently was in some kind of a difficulty and wanted to discuss his problems with Harvey. Inasmuch as Roselli cancelled his trip to Washington, Harvey is now of the opinion that Roselli's unidentified problems have now been lessened or alleviated.

Harvey made it clear that he will advise the Bureau immediately if he is ever contacted by the subject.

ACTION:

The above information is being directed to the attention of the Criminal Intelligence Unit of the Special Investigative Division. *u*

SJP:jad *jad*
(4)

- 1 - T. J. McAndrews
- 1 - Liaison
- 1 - S. J. Papich *P*

REC 53

92-3307-841

EX-113

15 SEP 27 1967

54 OCT 3 1967

UNITED STATES GOVERNMENT

Memorandum

Tolson	_____
DeLoach	_____
Mohr	_____
Bishop	_____
Casper	_____
Callahan	_____
Conrad	_____
Felt	_____
Gale	_____
Rosen	_____
Sullivan	_____
Tavel	_____
Trotter	_____
Tele. Room	_____
Holmes	_____
Gandy	_____

TO : Mr. D. J. Brennan, Jr. *JMB* DATE: 10/9/67

FROM : S. J. Papich *SJP* 1 - Mr. McAndrews
1 - Liaison
1 - Mr. Papich

SUBJECT: JOHN ROSELLI
ANTI-RACKETEERING

Reference is made to my memorandum dated 9/25/67. Howard Osborn, Director of Security, Central Intelligence Agency (CIA), advised the Liaison Agent on 10/4/67 that he had met with William Harvey, former CIA employee on 10/3/67. Osborn explained that he has been instructed by Richard Helms, Director of CIA, to periodically contact Harvey in order to make certain that CIA interests are fully protected.

McAndrews
Rosen
Bishop
Conrad

Harvey told Osborn that he had recently received a telephone call from the subject and the conversation lasted approximately one hour. Harvey indicated that not much of any significance came out of this conversation. Roselli told him that he was no longer concerned about a problem he was having with a Grand Jury. Subject did significantly mention to Harvey that he would never reveal his past relationship with CIA. Subject commented that he could never overlook the possibility that some "outsider" might "leak" Roselli's past connection with a CIA operation.

Harvey asked Osborn if CIA had any ties with Robert Maheu. Osborn told him that he did not know (Osborn informed the Liaison Agent that CIA is not in any way connected with Maheu). Harvey made no further comment on this particular item, but Osborn felt it was significant that Harvey brought up Maheu's name.

R

Harvey told Osborn that he was in the process of obtaining clearance for admittance into the D.C. Bar. He stated that Roselli made it clear that he could provide clients and Harvey could make as much as \$100,000 per year. Harvey stated that he would never get involved with any clients recommended by subject.

92-3267853

SJP:rab/lmr
(4)

ALL INFORMATION CONTAINED
HEREIN IS UNCLASSIFIED

CONTINUED - OVER

DATE *3/5/81* BY *SJP/gml/koa*
FOIA # *22330* copies made of *Serial 853*

12 OCT 18 1967

Re
66 OCT 26 1967

2/78 DJC
re: W.K. Harvey
for review of *SS 110* by
HSCA re *1/10/78* report.
(See *FOIA*)

LEGGETT
NINE

*CIA INFO unclassified per let John E. Bacon 8/27/80

Memorandum S. J. Papich to D. J. Brennan, Jr.
RE: JOHN ROSELLI
ANTI-RACKETEERING

On 10/5/67, Harvey contacted Agent Papich and in substance furnished the same information as above. In addition, he stated that he learned from Roselli that subject had been scheduled to appear before a Grand Jury concerning a charge relating to his citizenship status. Roselli made the statement, "Someone claims I was not born in the United States." He told Harvey he was not worried. Subject also indicated there was an investigation regarding alleged illegal gambling operations at the Friars Club in Los Angeles, and an allegation had been made that subject was involved. Roselli stated that members of the club had absolved him of any involvement.

It should be noted that Harvey told Osborn and Papich that the conversation with Roselli lasted approximately one hour. The information volunteered by Harvey certainly does not suggest a conversation of that length. The observation is therefore being made that Harvey may not be divulging all that is taking place between him and Roselli. This is strictly speculation.

At the end of the meeting, Harvey stated that he will continue to report all contacts with Roselli. He emphasized that he was fully aware of the dangers involved in dealing with Roselli and that he was completely cognizant of Bureau interests and responsibilities. He commented that he certainly had no desire to make a fool of himself and he had every intention to fully cooperate with the Bureau.

ACTION:

The above information is being directed to the attention of the Criminal Intelligence Unit of the Special Investigative Division. W

FBI

Date: 10/11/67

Transmit the following in _____
(Type in plaintext or code)

Via AIRTEL AIR MAIL - REGISTERED
(Priority)

ALL INFORMATION CONTAINED
HEREIN IS UNCLASSIFIED ^{70 JPAT 22,33}
DATE 3/5/81 BY SP4 Jmm/Ker
* CIA Info unclassified per John E. Buc
8/27/80

TO: DIRECTOR, FBI (92-3267)
FROM: SAC, LOS ANGELES (92-113)
RE: JOHN ROSELLI, aka
AR
OO: LOS ANGELES

Re Bureau airtel to Los Angeles dated 8/17/67, re the objections of CIA to the appearance of Colonel SHEFFIELD EDWARDS as a witness in the case involving the alien status of JOHN ROSELLI.

It is again noted that the appearance of Colonel EDWARDS as a witness would strengthen the case against ROSELLI tremendously. Although it is the plan of AUSA DAVID R. NISSEN to obtain an indictment against ROSELLI on Friday, 10/13/67, NISSEN has admitted that the case against ROSELLI is not "air tight" and investigation is continuing in an endeavor to locate additional witnesses.

The following is submitted for the Bureau's consideration:

It is the understanding of this office that Colonel EDWARDS is no longer with CIA, being described as "former Director of Security." If Colonel EDWARDS was a witness in this case, it would appear that he could, on the witness stand, furnish his name, his current employment, and the fact that he was acquainted with ROSELLI. Thereafter, he could testify concerning his meeting with ROSELLI, at ROSELLI's

③ - Bureau
2 - Los Angeles
HFD/mjg
(5)

REC-44 92-3267-854
EX-115
airtel to LA
10-20-67
REK: [signature]

15 OCT 18 1967

Approved: _____ Sent _____ M Per _____
Special Agent in Charge

LA 92-113

request, in Washington, D.C. in May, 1966, and to the fact that at this meeting ROSELLI stated that FBI Agents left at his residence in Los Angeles a picture of him as a young boy. It is recalled that this picture is, in fact, a picture of FILIPPO SACCO.

It does not appear that EDWARDS' former employment with CIA or ROSELLI's activity in a CIA operation would be either relevant or pertinent. The pertinent - relevant facts are that ROSELLI called him, made an appointment to see him, and admitted that the photograph was of him as a young boy.

It is requested that the Los Angeles Office be authorized to advise AUSA NISSEN of ROSELLI's conversation with Colonel EDWARDS and to obtain an opinion from him as to whether or not Colonel EDWARDS could appear as a witness and testify to the above mentioned facts without being required to give his former employment with CIA or ROSELLI's association with CIA.

An alternative would be for the Bureau to get an opinion from the Department of Justice concerning this matter. U

Thereafter, if the opinion of the U. S. Attorney in Los Angeles or the Department of Justice was that Colonel EDWARDS could testify without the CIA background being disclosed, then CIA could again be approached for permission for Colonel EDWARDS to appear as a witness against ROSELLI.

BA

October 20, 1967

DECLASSIFIED BY SPT Jmm/kaw
ON 3/5/81 FOIPA # 22,330

Airtel *CIA info declassified per John E. Bacon 8/27/80

~~TOP SECRET~~

To: SAC, Los Angeles (92-113)

From: Director, FBI (92-3267) — 854

JOHN ROSELLI, aka
ANTI-RACKETEERING
OO: LOS ANGELES

EX-115

Classified by 6049
Exempt from GDS, Category 2
Date of Declassification Indefinite
11/29/77
Oct 1968

ReBuairtel, 8/17/67, and Los Angeles airtel, 10/11/67.

The information developed through the contact between Sheffield Edwards and John Roselli was furnished to the Bureau by the Central Intelligence Agency (CIA) in confidence with the request that it not be released outside the Bureau. It is classified "Top Secret" by the CIA. TS(u)

The Bureau again recontacted CIA officials on 10/18/67, at which time they reiterated the restrictions imposed upon release of this information outside the Bureau. CIA again emphasized that it would be inimical to national security interests to have Edwards testify before a grand jury where he would be exposed to the possibility of making statements relating to CIA's past relationship with the subject.

CIA further advised that there is some discrepancy between the information attributed to Edwards concerning the subject as reported to the Bureau in CIA letter 5/18/66, and statements recently made to CIA by Edwards. TS(u)

MAILED 12
OCT 20 1967
COMM-FBI

TOP SECRET

Edwards is age 65, possesses a severe speech impediment and is in poor health.

In view of the foregoing, Los Angeles is not authorized to advise the United States Attorney's Office of Roselli's conversation with Edwards. In absence of additional developments, no inquiry of the Department will be initiated by the Bureau at this time in this matter.

- Tolson _____
- DeLoach _____
- Mohr _____
- Bishop _____
- Casper _____
- Callahan _____
- Conrad _____
- Felt _____
- Gale _____
- Rosen _____
- Sullivan _____
- Tavel _____
- Trotter _____
- Tele. Room _____
- Holmes _____
- Gandy _____

REK:mfd
(4)
NOTE: See page 2

REK

APPROPRIATE AGENCIES
AND FIELD OFFICES
ADVISED BY ROUTING
SLIP(S) OF DECLASSIFIED
DATE 3-25-81 SH

agc
jst

55 NOV 1 1967

MAIL ROOM TELETYPE UNIT

Airtel to SAC, Los Angeles
Re: JOHN ROSELLI, aka.
Bufile 92-3267

Los Angeles should continue to attempt to disprove Roselli's claim to citizenship through other witnesses. U

Note: Roselli is leading LCN figure on West Coast. Bureau investigation has disclosed Roselli actually born Filippo Sacco in Italy. Roselli, during contact with CIA, developed close association with former CIA official Colonel Sheffield Edwards. In May of 1966, Roselli indicated indirectly to Edwards his true identity as Sacco and Los Angeles feels Edwards' testimony would assist in disproving Roselli's claim to American citizenship. CIA recontacted and still strongly against having its association with Roselli possibly brought to light for national security reasons. They also advise Edwards previous information, asset out in CIA letter to Bureau 5/18/66, is at variance with his recent statements to CIA. He is also in poor health. In view of above, Los Angeles must be advised not to disclose Edwards' identity and information to USA. *AS(u)*

~~TOP SECRET~~

UNITED STATES GOVERNMENT

Memorandum

- Tolson _____
- DeLoach _____
- Mohr _____
- Bishop _____
- Casper _____
- Callahan _____
- Conrad _____
- Felt _____
- Gale _____
- Rosen _____
- Sullivan _____
- Tavel _____
- Trotter _____
- Tele. Room _____
- Holmes _____
- Gandy _____

TO : Mr. D. J. Brennan, Jr. *[Handwritten initials]*

DATE: 10/19/67

FROM : S. J. Papich *[Handwritten initials]*

- 1 - T. J. McAndrews *[Handwritten initials]*
- 1 - Mr. Kent *[Handwritten initials]*
- 1 - Liaison
- 1 - Mr. Papich *[Handwritten initials]*

SUBJECT: JOHN ROSELLI
ANTI-RACKETEERING

Howard Osborn, Director of Security, Central Intelligence Agency (CIA), advised the Liaison Agent on 10/18/67 that the restrictions imposed by CIA for protecting CIA information as described in the Agency's communication of 8/14/67 are still in effect as far as CIA is concerned. Osborn emphasized that in the opinion of CIA it would be against national interests to have Colonel Sheffield Edwards testify before a Grand Jury or at any trial where Edwards would be exposed to making statements relating to CIA's past relationship with the subject. *[Handwritten initials]*

Osborn further stated that there is also some discrepancy between the information attributed to Edwards and reported to the Bureau by CIA letter dated 5/18/66 and statements recently made to CIA by Edwards. CIA is submitting a letter to us to cover this particular point.

ACTION:

The above information is being directed to the attention of the Criminal Intelligence Unit of the Special Investigative Division. *[Handwritten mark]*

SJP:rab
(5)

ALL INFORMATION CONTAINED
HEREIN IS UNCLASSIFIED *70SPQ #22,330*
DATE 3/5/81 BY SP4-*[Handwritten initials]*

*CIA info unclassified per John E. Bacon 8/27/80

REL: 30

EX-113

OCT 25 1967

57 NOV 1 1967 *[Handwritten initials]*

[Handwritten signatures and initials]

UNITED STATES GOVERNMENT

Memorandum

TO : Mr. W. C. Sullivan

FROM : D. J. Brennan, Jr. *DJB*

SUBJECT: JOHN ROSELLI
ANTI-RACKETEERING

1 - Mr. DeLoach
1 - Mr. Sullivan

DATE: 11/1/67

1 - Mr. Gale
1 - Mr. McAndrews
1 - Liaison
1 - S. J. Papich

Tolson ✓
DeLoach ✓
Mohr ✓
Bishop ✓
Casper ✓
Callahan ✓
Conrad ✓
Felt ✓
Gale ✓
Rosen ✓
Sullivan ✓
Tavel ✓
Trotter ✓
Tele. Room ✓
Holmes ✓
Gandy ✓

SYNOPSIS:

Subject, a top hoodlum, recently indicted and arrested on charges of failure to register as alien and failure to keep Attorney General advised of his whereabouts. Currently out on bail. Central Intelligence Agency (CIA) established relationship with him about 1960 when Agency devised plan to assassinate Fidel Castro through utilization of hoodlum element. Plan never implemented. Its existence continues to be potential source of embarrassment to CIA if plan is publicly exposed. Roselli is in position to blackmail CIA. William Harvey, former Bureau Agent now retired from CIA, was one of CIA officials who established relationship with subject. Relationship continues. Harvey periodically volunteers information to Special Agent Papich. Harvey met with Richard Helms, CIA, 10/30/67 and advised subject is seeking help as result of indictment; apparently looking to CIA to intercede in his behalf. Harvey's role in this situation definitely questionable. Helms advised SA Papich 10/31/67 that he mistrusts Harvey; that he is not going to permit himself or CIA to be blackmailed by anybody; and he has no fear of any threats which may emanate from subject.

ACTION:

SA Papich has been adhering to a line of accepting any information Harvey volunteers. No information is given to Harvey. If approved, Agent Papich will continue accepting Harvey's information as he volunteers it.

SJP:kw
(7)

We must be very careful in any meetings with Harvey.

53 NOV 15 1967
NOV 14 1967

REC-42

18 NOV 7 1967

CONTINUED - OVER

* CIA INFO UNCLASSIFIED
 PER JOHN E. BACON 8/27/80
 ALL INFORMATION CONTAINED
 HEREIN IS UNCLASSIFIED
 DATE 3/5/81 BY SP4-Jym/kt

we must be very careful in any meetings with Harvey

Right & vigorously press case against Roselli.

5-1000

DATE

W.C. Sullivan

John DeLoach

Richard Helms

Papich

92-5461-863

PERS. REC. UNIT

Memorandum to Mr. W. C. Sullivan
RE: JOHN ROSELLI

DETAILS:

The subject, a top hoodlum, was recently indicted and arrested on charges of failure to register as an alien and failure to keep the Attorney General advised of his whereabouts. He is currently out on bail. You previously have been informed concerning a relationship between the subject and the CIA which developed a few years ago when CIA concocted a plan to assassinate Fidel Castro. Utilization of certain U.S. hoodlum types was a key element of the plan which was never implemented.

William Harvey, former Bureau Agent and now retired from CIA, was one of the CIA officials who established a relationship with Roselli. From time to time Harvey has volunteered information to Special Agent Sam Papich, which data Harvey has obtained from what appears to be occasional contacts with subject. Harvey also contacts CIA officials and maintains that he has not been able to sever the relationship with the subject for fear that Roselli might become antagonized and consequently become a problem. In this connection Roselli is in a position to hurt CIA if he desires to expose his involvement with the Agency in the plot to assassinate Castro. He does have this hanging over CIA's head.

On 10/27/67 Harvey telephonically contacted Agent Papich from New York City and stated that he wanted to confer with the Bureau Agent when he returned to Washington on or about 10/31/67. Harvey contacted Agent Papich on the morning of 10/31/67 and asked for a meeting. The Agent has indicated that he would try to see him later in the week. ~

In the meantime, Harvey has been in contact with CIA. Howard Osborn, Director of Security, CIA, advised the Liaison Agent on 10/30/67 that Harvey had met that morning with Osborn and Richard Helms, Director, CIA. At that meeting, Harvey stated that he had received a communication from subject concerning his indictment

Memorandum to Mr. W. C. Sullivan
RE: JOHN ROSELLI

and arrest. According to Harvey, Roselli "is looking for help." Harvey told the CIA officials that subject obviously is probing to determine if CIA can intervene on his behalf. Harvey told Helms that he was seeking advice and guidance for his future contacts with subject. Helms told Harvey that he would give the matter some thought and would be in touch with him.

During the course of the conversation with the CIA officials, Harvey volunteered that he personally has had some contact with Ed Morgan, former Bureau Agent, who is practicing law in the D. C. area. Harvey explained that since he himself was admitted to the D. C. Bar in the very recent past, he was making a point of establishing contact with some lawyers in the area whom he personally knew. Harvey made the observation that Morgan obviously was very well informed concerning CIA's past relationship with Roselli. Harvey assumes that Morgan acquired this information from Robert Maheu, another former Bureau Agent, who was utilized by CIA when it initiated its contacts with the hoodlum elements for planning of the Castro assassination.

Osborn advised in strict confidence that he and Helms had very serious doubts that Harvey was divulging all information he possesses concerning subject. Osborn is confident that Harvey is holding out and possibly has become involved in some financial proposition with subject.

OBSERVATIONS:

Harvey has been fully apprised of the dangers stemming from any association he may maintain with subject. He very clearly knows that Roselli is a top hoodlum and subject of a Bureau investigation. Harvey has indicated that he has no intention of becoming involved in any illegal or criminal activities and that he wants to cooperate fully with the Bureau. He has not asked for any information but has been careful to report his contacts with subject. Whether or not he has reported adequately is a matter of conjecture. It

Memorandum to Mr. W. C. Sullivan
RE: JOHN ROSELLI

should be noted that instead of withdrawing from a relationship with Roselli, he seems to be getting in deeper. His role in this situation is definitely questionable.

On 10/31/67 Richard Helms furnished Agent Papich essentially the same information as that made available by Osborn of CIA. Helms made it emphatically clear that he mistrusts Harvey; that he is not going to permit himself or CIA to be blackmailed by anybody; and that he has no fear of any threats which may emanate from subject. Helms commented that as far as he is concerned the Bureau can treat Harvey as it sees fit.

UNITED STATES GOVERNMENT

Memorandum

Tolson	_____
DeLoach	_____
Mohr	_____
Bishop	_____
Casper	_____
Callahan	_____
Conrad	_____
Felt	_____
Gale	_____
Rosen	_____
Sullivan	_____
Tavel	_____
Trotter	_____
Tele. Room	_____
Holmes	_____
Gandy	_____

TO : Mr. W. C. Sullivan

DATE: November 7, 1967

FROM : D. J. Brennan, Jr. *DJB*

- 1 - Mr. DeLoach
- 1 - Mr. Sullivan
- 1 - Mr. Gale
- 1 - Mr. McAndrews
- 1 - Liaison
- 1 - Mr. Papich

SUBJECT: JOHN ROSELLI
ANTI-RACKETEERING

SYNOPSIS:

William Harvey, former Bureau Agent and retired Central Intelligence Agency (CIA) employee, met with Agent Papich on November 6, 1967. Harvey described his recent conversations with Roselli. Roselli asked Harvey to act as his legal counsel, and Harvey claims he turned him down. Subject did indicate that he might need somebody to intercede in his behalf in connection with the recent indictment returned against him. Harvey expressed opinion that case against subject was weak. He inquired if Agent could make any observations regarding case. Harvey was told that this definitely could not be done now or in the future. The subject may come to Washington, D. C., within the next week or two; Harvey states he will keep us advised regarding developments. *u*

ACTION:

For information. *u*

DETAILS:

Reference is made to my memorandum dated November 1, 1967. Set forth are the results of a meeting which Special Agent Papich held with William Harvey on November 6, 1967. *u*

Harvey stated that Roselli telephonically contacted him from Los Angeles on or about October 22, 1967, to advise that he was indicted on a charge of failure to register as an

SJP:clb
(7)

CONTINUED - OVER

Hight
XEROX
NOV 24 1967

54 NOV 27 1967

EX-NONE

* CIA Info Unprocessed per Let
 John E. Bacon 8/27/80
 # 101,330
 BY SP4-9/m/kaa
 DATE 2/5/81

ALL INFORMATION CONTAINED
 HEREIN IS UNCLASSIFIED

Handwritten initials and signatures:
W.C. Sullivan
DJB
McAndrews
Papich

REC 18
72-3267-868
 NOV 16 1967

Memorandum to Mr. W. C. Sullivan
RE: JOHN ROSELLI

alien. Roselli wanted to know if Harvey could serve as his legal counsel. Harvey told subject that this was impossible. Subject made it quite clear that he was concerned and that he might need somebody to intercede in his behalf. Harvey subsequently received a newspaper clipping from subject which referred to the aforementioned indictment. U

Roselli again contacted Harvey by telephone on or about October 27, 1967. Subject reiterated his concern but at the same time indicated that the case against him was weak. He left the impression with Harvey that this assessment of the case came from subject's attorney, Cantallon, (phonetic) in Los Angeles. Roselli stated that an attorney named "Breen" (phonetic) has been very helpful to Cantallon. Roselli again asked if Harvey could act as his legal counsel, and Harvey told him this could not be done. Roselli stated that he had been in contact with Ed Morgan, and Harvey surmises that Morgan will end up acting as Roselli's attorney in Washington, D. C. U

Subject commented that he could not see why charges against him could not be dropped as they had been in the Government case against Robert Maheu. Roselli was referring to the wire tapping charge against Maheu which occurred a few years ago. Roselli stated that Ed Morgan was fully aware of the maneuvering which saved Maheu. Subject further indicated that Morgan obviously had been fully briefed concerning CIA's relationship with Roselli, and this had been done by Maheu.

Harvey volunteered his opinion (this could be his opinion or he could be furnishing the evaluation made by Roselli) that the case was weak; that the subject could easily establish there was no willful intent to violate any law; and that if subject had known that he had another identity, he easily could have rectified the situation by becoming a United States citizen after serving in the United States Army during World War II. U

Memorandum to Mr. W. C. Sullivan
RE: JOHN ROSELLI

Harvey inquired if Agent Papich could make any observations regarding the current case against subject. Papich told Harvey that this very definitely could not be done; that the Agent had no idea regarding the nature of the evidence collected; and that he specifically had made a point of not having access to such information. The Agent emphasized that Harvey must clearly understand that his relationship with Roselli placed him in a quasi counsel position and that no Bureau Agent could discuss the substance of the case with Harvey. Harvey stated that he was not seeking any information, but he did want to know if there is anything that he could be told which might assist him in following developments with Roselli. The Agent reiterated that Harvey could not expect anything from him now or in the future, but Harvey was free to volunteer any information if he so desired. Harvey stated that he knew where he stood and that he would be guided accordingly. u

Harvey stated that Roselli would be in town within the next week or two and that he would keep the Agent advised of any developments. Agent Papich inquired if Roselli was cognizant of Harvey's contact with a Bureau Agent. Harvey replied, "definitely not." u

ways
Press vigorously
RB
new set
had

UNITED STATES GOVERNMENT

Memorandum

Tolson	_____
DeLoach	_____
Mohr	_____
Bishop	_____
Casper	_____
Callahan	_____
Conrad	_____
Felt	_____
Gale	_____
Rosen	_____
Sullivan	_____
Tavel	_____
Trotter	_____
Tele. Rm.	_____
Holmes	_____

TO : Mr. D. J. Brennan, Jr. *[Handwritten initials]*

DATE: November 21, 1967

FROM : S. J. Papich *[Handwritten initials]*

- 1 - Mr. McAndrews
- 1 - Liaison
- 1 - Mr. Papich *[Handwritten initials]*

SUBJECT: JOHN ROSELLI
ANTI-RACKETEERING

William Harvey telephonically furnished the following information to the Liaison Agent on November 20, 1967: *[Handwritten mark]*

The subject has advised Harvey that he will arrive in Washington, D. C., on November 25 or November 26, 1967, and will remain for two or three days. Subject plans to be in contact with Harvey and indicated that he will also meet with his attorney, Ed Morgan *[Handwritten mark]*

Harvey advised that he did not have any additional information but that he would keep the Agent apprised of all developments. *[Handwritten mark]*

ACTION:

The above information is being directed to the attention of the Criminal Intelligence and Organized Crime Section of the Special Investigative Division. *[Handwritten mark]*

SJP:clb *[Handwritten initials]*
(4)

ALL INFORMATION CONTAINED
HEREIN IS UNCLASSIFIED *[Handwritten: 702 part 22,330]*
DATE 3/5/81 BY Sgt. Jm/Kew
*[Handwritten: *CIA Info unclassified per let John E. Bacon 8/27/80]*

REC-52

X-103

92-3267-875

13 NOV 30 1967

53 DEC 6 1967

UNITED STATES GOVERNMENT

Memorandum

Tolson	_____
DeLoach	_____
Mohr	_____
Bishop	_____
Casper	_____
Callahan	_____
Conrad	_____
Felt	_____
Gale	_____
Rosen	_____
Sullivan	_____
Tavel	_____
Trotter	_____
Tele. Room	_____
Holmes	_____
Gandy	_____

TO : Mr. D. J. Brennan, Jr. *MB*

DATE: December 12, 1967

FROM : S. J. Papich *SP*

1 - Mr. McAndrews
 1 - Liaison
 1 - Mr. Papich

SUBJECT: JOHN ROSELLI
ANTI-RACKETEERING

9-McAndrews

On December 8, 1967, William Harvey advised the Liaison Agent that he had meetings with the subject on November 27, 28, and 29, 1967. Harvey advised that the meetings produced the following items: *u*

1. Roselli stayed at the Madison Hotel and was registered in his own name. *u*

2. He is currently negotiating to buy a radio station in San Jose, California. He conferred with Edward Morgan, in Washington, D. C., in connection with this particular matter. *u*

3. He made brief reference to his current girlfriend who is 21 years of age and allegedly "comes from a good family." Recently, Roselli was unsuccessful in having the girl join him at Palm Springs because of pressure put on the girl by her parents. *u*

4. Roselli displayed to Harvey a copy of an application for membership to the Friars Club and a copy of his resignation from this same club. His application indicated that his character references were Dean Martin, Frank Sinatra, and George Jessel. *u*

5. Roselli stated that the name of Phillippo Sacco has never meant anything to him and that nobody ever told him that he had any other identity. *u*

6. Subject recently recovered from an attack of pneumonia. He claims that he was confined to his apartment for approximately three weeks. *u*

SJP:clb
(4) *clb*

REC 48

CONTINUED - OVER

EX 109

9-3067-879

105
54 DEC 19 1967

ALL INFORMATION CONTAINED
HEREIN IS UNCLASSIFIED

DATE 3/5/81 BY SP4-JDM/KCR

*CIA Info unclassified per John E. Bacon

DEC 13 1967

Memorandum S. J. Papich to Mr. D. J. Brennan, Jr.
RE: JOHN ROSELLI

7. Subject stated that he has not seen Sam Giancana since 1965. ✓

Harvey inquired if he personally could be informed whether or not there is any evidence that Roselli has not seen Giancana since 1965. He commented that if Roselli is definitely lying on this point, it would be most helpful to him, Harvey, in governing his relations with the subject. ✓

ACTION:

The above information and Harvey's request are being directed to the attention of the Criminal Intelligence and Organized Crime Section of the Special Investigative Division. ✓

*I advised Harvey we couldn't
furnish him any info.*

*RS
12/19/67*

UNITED STATES GOVERNMENT

Memorandum

Tolson	_____
DeLoach	_____
Mohr	_____
Bishop	_____
Casper	_____
Callahan	_____
Conrad	_____
Felt	_____
Gale	_____
Rosen	_____
Sullivan	_____
Tavel	_____
Trotter	_____
Tele. Room	_____
Holmes	_____
Gandy	_____

TO : Mr. D. J. Brennan, Jr. *[Signature]*

DATE: January 2, 1968

FROM : S. J. Papich *[Signature]*

SUBJECT: JOHN ROSELLI
ANTI-RACKETEERING

[Handwritten signatures and initials: Staff, Sullivan, M. Andrews]

William Harvey, Central Intelligence Agency (CIA), furnished the following to the Liaison Agent on December 28, 1967: *u*

The subject sent Harvey a brief letter enclosing a copy of his recent indictment. Subject referred to this development as a "sophisticated way of blackmail by indictment." Harvey advised that Roselli did not furnish any additional information and has not asked for any assistance from Harvey. *u*

ACTION:

The above information is being directed to the attention of the Criminal Intelligence and Organized Crime Section of the Special Investigative Division. *u*

SJP:clb *[Signature]*
(4)

- 1 - Mr. McAndrews
- 1 - Liaison
- 1 - Mr. Papich

ALL INFORMATION CONTAINED
HEREIN IS UNCLASSIFIED *70-100-22,330*
DATE 3/6/81 BY SP4-DM/KAC
** CIA Info unclassified per John E. Bacon 8/27/80*

REC 3

3 JAN 5 1968

EX-108

NAVE

300

[Handwritten initials]

UNITED STATES GOVERNMENT

Memorandum

- Tolson _____
- DeLoach _____
- Mohr _____
- Bishop _____
- Casper _____
- Callahan _____
- Conrad _____
- Felt _____
- Gale _____
- Rosen _____
- Sullivan _____
- Tavel _____
- Trotter _____
- Tele. Room _____
- Holmes _____
- Gandy _____

TO : Mr. D. J. Brennan, Jr. *[Signature]*

DATE: January 30, 1968

FROM : S. J. Papich *[Signature]*

SUBJECT: ^① JOHN ROSELLI
ANTIRACKETEERING

[Handwritten initials] 9- *[Signature]*
[Signature]
[Signature]

William Harvey, former Central Intelligence Agency (CIA) employee, advised the Liaison Agent on January 26, 1968, that the subject had mailed him copies of motions which had been filed by Roselli's attorney. The subject did not ask for any assistance or for any comments from Harvey. *[Handwritten mark]*

Harvey asked the Liaison Agent if he had read the indictment against the subject. The Agent replied in the negative. There was no further discussion on this item. *[Handwritten mark]*

Harvey then volunteered the observation that if Roselli were deeply involved in organized crime, and he acknowledged that this undoubtedly was true, the subject undoubtedly was serving in the role of "advocato." He stated that he was using this Italian term which essentially meant that the subject would act as an arbitrator or mediator if and when "squabbles" or differences arose in "the organization." Harvey was convinced that Roselli was the type who could "fix" or correct any disruptive situations. He stated that this was strictly his own analysis based upon his brief association with the subject. *[Handwritten mark]*

Harvey did not volunteer any additional information. *[Handwritten mark]*

ACTION:

The above information is being directed to the attention of the Crime Intelligence and Organized Crime Section of the Special Investigative Division. *[Handwritten mark]*

SJP:clb
(4)

- 1 - Mr. McAndrews
- 1 - Liaison
- 1 - Mr. Papich

92-3-1-900

REC-20

EX 106

FEB 6 1968

55 FEB 13 1968

ALL INFORMATION CONTAINED
 HEREIN IS UNCLASSIFIED
 DATE 3/6/81 BY SP4-*[Signature]*
 * CIA Info unclassified per
 John E. Bacon 8/29/80

UNITED STATES GOVERNMENT

Memorandum

Tolson	_____
DeLoach	_____
Mohr	_____
Bishop	_____
Casper	_____
Callahan	_____
Conrad	_____
Felt	_____
Gale	_____
Rosen	_____
Sullivan	_____
Tavel	_____
Trotter	_____
Tele. Room	_____
Holmes	_____
Gandy	_____

TO : Mr. D. J. Brennan, Jr. *[Handwritten initials]*

DATE: March 20, 1968

FROM : S. J. Papich *[Handwritten initials]*

SUBJECT: JOHN ROSELLI
ANTIRACKETEERING

William Harvey, CIA, telephonically contacted me on the morning of March 20, 1968, and advised as follows: *u*

Subject called Harvey on March 19, 1968, stating that he was in Washington, D. C., and wanted to talk to Harvey. They had a brief meeting on the afternoon of March 19, 1968, at which time subject gave "a fill-in on pleadings" relating to his case. Roselli did not ask for any assistance. He did not appear to be "deeply concerned" with his situation, but according to Harvey subject obviously is "irritated." Harvey will have another meeting with Roselli on the evening of March 21, 1968. He stated that he will contact me if anything of significance comes out of this meeting. *u*

ACTION:

The above information is being directed to the attention of the Criminal Intelligence and Organized Crime Section of the Special Investigative Division. *u*

SJP:clb *clb*
(4)

- 1 - Mr. McAndrews
- 1 - Liaison
- 1 - Mr. Papich

**ALL INFORMATION CONTAINED
HEREIN IS UNCLASSIFIED**

DATE 3/6/81 BY SP4-jmp/kca

* CIA info unclassified per John E. Bacon 8/27/80

REC-97

7-3267-934

3 MAR 22 1968

62 MAR 29 1968

NINE
Ruf...

UNITED STATES GOVERNMENT

Memorandum

- Tolson _____
- DeLoach _____
- Mohr _____
- Bishop _____
- Casper _____
- Callahan _____
- Conrad _____
- Felt _____
- Gale _____
- Rosen _____
- Sullivan _____
- Tavel _____
- Trotter _____
- Tele. Room _____
- Holmes _____
- Gandy _____

TO : Mr. W. C. Sullivan

DATE: 3/29/68

FROM : D. J. Brennan, Jr.

SUBJECT: JOHN ROSELLI
ANTIRACKETEERING

ALL INFORMATION CONTAINED
HEREIN IS UNCLASSIFIED 70 IP# 22,330
DATE 3/6/81 BY SP4-jmm/kca

*CIA Info unclassified per
John E. Bacon 8/27/80

You previously have been informed that in 1960, the Central Intelligence Agency (CIA) established a relationship with the captioned hoodlum at which time the Agency had devised a plan to assassinate Fidel Castro through the utilization of the hoodlum element. The plan was never implemented, but CIA was left in a potentially embarrassing position bearing in mind that Roselli certainly had the capability of blackmailing CIA. William Harvey, former Bureau Agent and now retired from CIA, was one of the CIA officials who maintained a relationship with Roselli. Harvey has continued periodic contact with Roselli. He has periodically volunteered information to Special Agent Papich; this information has not been of any unusual significance.

On 3/28/68 Richard Helms, Director of CIA, advised the Liaison Agent that Harvey had called on him on 3/27/68. At that time Harvey briefly reviewed the background of CIA's involvement with the subject and then emphasized to Helms that Roselli's case on the West Coast was developing to a point which necessitated some serious thinking on the part of CIA. Harvey told Helms that Ed Morgan is now serving as legal counsel for the subject in Washington, D. C., and he pointed out that Morgan was fully aware of the background and details concerning CIA's involvement with Roselli. Harvey stated that he personally was not being retained as legal counsel for the subject but claimed that he had a responsibility of protecting CIA interests and at the same time was of the strong opinion that the Agency should try to help Roselli.

SJP:clb
(7)

REC-40
CONTINUED - OVER 92-3267-94

- 1 - Mr. DeLoach
- 1 - Mr. Gale
- 1 - Mr. Sullivan
- 1 - Mr. McAndrews
- 1 - Liaison
- 1 - Mr. Papich

EX 101

10 APR 10 1968

57080

NINE

66 APR 11 1968
202 39

Ⓞ

Memorandum D. J. Brennan, Jr., to Mr. W. C. Sullivan
RE: JOHN ROSELLI

Helms advised that he accepted Harvey's statements as a form of pressure, and he then made it very clear to Harvey that CIA was not making any kind of a deal with the subject or anybody else. He told Harvey that if he saw any necessity to discuss the matter in the future, he would contact him.

Helms confided to the Agent that he was not going to be squeezed into any position by Harvey, Roselli, or any other individuals. At this point he feels very strongly that if Roselli or any of his supporters are inclined to expose CIA's past involvement with the subject he, Helms, was prepared to take the consequences. He stated that he would much rather do this than inject himself in any kind of a negotiation with the subject.

Helms stated that he fully realizes that at some point it may become necessary to confer with the Attorney General. He does not want to do this for the time being. He is asking his subordinates to make a complete review of all CIA records relating to the above-described 1960 plan. He feels that he then would be in a much better position to discuss all aspects with somebody like the Attorney General.

As previously reported Agent Papich has met with Harvey from time to time, and this has always taken place at the request of Harvey, who indicated he had information to furnish the Bureau. So far this has not been a problem, but from now on you cannot exclude the possibility that Harvey truly does have a lawyer-client relationship with Roselli. If so it would not be prudent for a Bureau Agent to continue contact with Harvey on any matters dealing with the instant case. U

ACTION:

If approved, Agent Papich will inform Harvey that because of the latter's relationship with the subject, the Liaison Agent will not be able to confer with him any more concerning any matters dealing with this case. U

ds ↓ OK: ↓ ds
a - 2 - ↓ ds
(SEE ADDENDUM, PAGE 3) ↓ ds

ADDENDUM; SPECIAL INVESTIGATIVE DIVISION; 4/2/68; MER:skh

By way of background, Roselli is a 62 year old La Cosa Nostra member who resides in Los Angeles and who has been reported for many years as the representative on the West Coast of the Chicago La Cosa Nostra family. U

Intensive investigation conducted into the background of Roselli revealed Roselli in actuality to be one Filippo Sacco. This investigation resulted in Roselli's arrest in October of 1967, as a result of his being indicted for Willful Failure To Apply For Registration As An Alien. In addition, this indictment charged five counts of Willfully Failing as an Alien to Give Written Notice to the United States Attorney General of his current addresses during January for the years 1963 through 1967. Roselli's trial on these charges commences April 2, 1968. U

Roselli was indicted on gambling charges in December of 1967, resulting from the investigation of card cheating at the Friars Club in Beverly Hills, California. In this investigation Roselli was charged with one count of Interstate Transportation in Aid of Racketeering - Gambling; three counts of Interstate Transportation of Stolen Property; one count of General Conspiracy; one count Federal Communications Commission; and one count of Subscribing to a False Income Tax Return. Trial in this matter has been set for June, 1968. U

A ✓ *Sacco* ✓ *Jes* ✓ *Ward* ✓ *nm*

UNITED STATES GOVERNMENT

Memorandum

Tolson	<input checked="" type="checkbox"/>
DeLoach	<input checked="" type="checkbox"/>
Mohr	<input type="checkbox"/>
Bishop	<input type="checkbox"/>
Casper	<input type="checkbox"/>
Callahan	<input type="checkbox"/>
Conrad	<input type="checkbox"/>
Felt	<input type="checkbox"/>
Gale	<input checked="" type="checkbox"/>
Rosen	<input checked="" type="checkbox"/>
Sullivan	<input checked="" type="checkbox"/>
Tavel	<input checked="" type="checkbox"/>
Trotter	<input type="checkbox"/>
Tele. Room	<input type="checkbox"/>
Holmes	<input type="checkbox"/>
Gandy	<input type="checkbox"/>

TO : Mr. W. C. Sullivan

DATE: 4/5/68

FROM : D. J. Brennan, Jr. *[Handwritten initials]*

SUBJECT: JOHN ROSELLI
ANTIRACKETEERING

[Handwritten signatures and initials: JH, Staffell, Brennan, Papich]

①

②

Reference is made to memorandum from Mr. Brennan to Mr. Sullivan dated 3/29/68. Set forth are additional developments which are being recorded for possible future reference. *[Handwritten mark]*

9
24

On 4/3/68 William Harvey asked to meet with Special Agent Papich. This meeting was held at which time Harvey merely reported that motions filed by the subject's attorneys in Los Angeles were rejected by the court and a trial date was set. (All of this is already known to us.) Agent Papich then told Harvey that in view of what very definitely appeared to be a well-established relationship between Harvey and Roselli, the Agent would not further meet with Harvey to discuss any matters dealing directly or indirectly with the case of Roselli. Harvey was visibly shaken and asked, "What is behind this?" The Agent replied that he, Harvey, having a legal background, should fully realize that further contact with a Bureau Agent just did not make sense. The Agent further elaborated by commenting that regardless of Harvey's denial that he was acting as legal counsel for Roselli, there is no doubt whatsoever that a close relationship exists and this could not be disregarded. Harvey then stated that he fully accepted the position taken by the Agent although he regretted this development because he desired to remain in a position where he possibly could be of assistance to the Bureau. He claimed that he is not giving Roselli any legal advice; that he is not receiving any kind of compensation; and that his only objective is to protect the interests of the FBI and CIA (Central Intelligence Agency). He was extremely critical of

ALL INFORMATION CONTAINED HEREIN IS UNCLASSIFIED
 DATE 3/16/81 BY SP4 Jmb/ka
 *CIA Info unclassified per John E. Bacon #22,330

SJP:clb
(7) *[Handwritten initials]*

CONTINUED - OVER

92-3267-946

- 1 - Mr. DeLoach
- 1 - Mr. Gale
- 1 - Mr. Sullivan
- 1 - Mr. McAndrews
- 1 - Liaison
- 1 - Mr. Papich

10 APR 10 1968

[Handwritten: NINE]

[Handwritten: 5-088]

[Handwritten: 1-cc - SSC 9/16/75]

APR 15 1968 LA, PE LV, SD
2A2 PJB:24

Memorandum D. J. Brennan, Jr., to Mr. W. C. Sullivan
RE: JOHN ROSELLI

CIA maintaining that the Agency does not fully appreciate the significance of exposure to potential embarrassment.

Harvey briefly commented that some people may forget that this is an election year. He followed by stating that Robert Kennedy was knowledgeable of the operation which had been devised by CIA with the collaboration of Roselli and his cohorts. Although he did not so state, Harvey definitely left the implication that Kennedy is in an extremely vulnerable position if it were ever publicized that he condoned an operation which involved U. S. Government utilization of hoodlum elements. Harvey stated that he was not certain if Kennedy was privy to the beginnings of the operation, but he definitely was cognizant of its existence in the late stages. He made it clear that this knowledge was in the possession of Kennedy while he was still Attorney General.

On 4/2/68 Richard Helms, Director of CIA, advised that he had received a call from Harvey indicating that motions filed by the subject's attorneys had been rejected. At that time, Harvey commented that the judge and the U. S. Attorney in Los Angeles undoubtedly were under considerable pressure from the Department of Justice. Helms stated that he made no comment regarding these statements, and he accepted Harvey's message as a further effort to convince Helms that the situation was becoming more critical for CIA. Helms stated that he is adhering to his position, namely, that he will not do anything to intercede in behalf of the subject.

Helms also confidentially advised that he has been in contact with the Attorney General concerning this matter, and he has specifically briefed the Attorney General concerning Harvey's contacts with the Agency. He did not elaborate any further on this.

ACTION:

For information. U

AM *P* *wcy* *JHG* *✓* *Adm* *nm*

4/19/68 *Keep pressure on Roselli case.* *nl*

4/15/68

Airtel

- 1 - Mr. DeLoach
- 1 - Mr. Sullivan
- 1 - Mr. Gale
- 1 - Mr. McAndrews
- 1 - Mr. Bannon

To: SAC, Los Angeles (92-113)

From: Director, FBI (92-3267)

JOHN ROSELLI, aka
AR

ALL INFORMATION CONTAINED
HEREIN IS UNCLASSIFIED

DATE 3/6/81 BY SP4-JAM/KEA
#2330

*CIA Info unclassified per
John E. Bacon 8/27/80

Referenced Los Angeles teletypes to the Bureau
April 10 and April 11, 1968.

For your information it has been ascertained that
Roselli has in the past when visiting Washington, D.C., contacted
William Harvey, formerly of CIA, who is now retired and practicing
law in Washington, D.C. Harvey has on each occasion of a contact
with Roselli advised CIA officials.

During the first week in April, 1968, a CIA official,
knowing of the present prospects for prosecution of Roselli,
alerted the Attorney General to the contacts which had been made
by Roselli with Harvey. It has been ascertained from CIA that
nothing will be done by that agency to intercede in behalf of
the subject.

MAILED 12
APR 15 1968
COMMENTS

It has been ascertained that Department Attorney Keeney
in his contact with the United States Attorney's Office in Los
Angeles merely was inquiring as to whether or not any pressures
had been experienced by the United States Attorney's Office which
might be interpreted as a desire for a dismissal or a reduction
in the charges placed against Roselli. Keeney stated ~~he did not~~
desire to imply that overtures in this regard had been received
in Washington, D.C.

REC-103 92-3267-94

APR 15 1968

During the discussion with Keeney, the latter ~~was most~~
emphatic in stating that the Department desired to push all
aspects of the prosecution of Roselli promptly and vigorously.

- Tolson _____
- DeLoach _____
- Mohr _____
- Bishop _____
- Casper _____
- Callahan _____
- Conrad _____
- Felt _____
- Gale _____
- Rosen _____
- Sullivan _____
- Tavel _____
- Tranter _____
- Tele. Rm. _____
- Holmes _____
- Gandy _____

PJB:slg

SEE GALE TO DELOACH MEMO CAPTIONED SAME DATED
4/12/68, PJB:kem.

APR 22 1968

MAIL ROOM TELETYPE UNIT

Airtel to Los Angeles
Re: John Roselli

In view of the above you should advise AUSA David R. Nissen that the Department is fully aware of the relationship between Roselli and CIA, and further that Attorney General Robert F. Kennedy was fully briefed by CIA after the Roselli-CIA relationship was established.

It should be tactfully suggested to AUSA Nissen that if he considers it necessary to obtain the information he desires from the CIA, he should obtain such through the Department of Justice. U

VIA TELETYPE
APR 12 1968
ENCIPHERED

Mr. Tolson	_____
Mr. DeLoach	_____
Mr. Mohr	_____
Mr. Bishop	_____
Mr. Casper	_____
Mr. Callahan	_____
Mr. Conrad	_____
Mr. Felt	_____
Mr. Gale	_____
Mr. Rosen	_____
Mr. Sullivan	_____
Mr. Tavel	_____
Mr. Trotter	_____
Tele. Room	_____
Miss Holmes	_____
Miss Gandy	_____

WASH DC --1--

1124AM URGENT 4-12-68 SMS

TO DIRECTOR (92-3267)

ENCODE

FROM LOS ANGELES (92-113)

*Stop
a
B
R*

JOHN ROSELLI, AKA. AR. OO-LA.

RE LA TEL TO BUREAU APRIL TWO LAST AND BUREAU AIRTEL TO LA APRIL NINE LAST.

nr

RE TEL SET FORTH DETAILS OF A MOTION BY DEFENSE FOR THE COURT TO REVIEW MATERIAL OBTAINED VIA ELECTRONIC SURVEILLANCE OF ROSELLI PRIOR TO TRIAL WHICH SCHEDULED TO BEGIN LA APRIL TWENTY THREE NEXT.

ON APRIL TWO LAST THE JUDGE RULED THAT THE ELECTRONIC SURVEILLANCE MATERIAL WOULD BE REVIEWED AFTER TRIAL IF ROSELLI FOUND GUILTY.

ON APRIL TEN LAST ROSELLI'S ATTORNEY JAMES P. CANTILLON IN THE ABSENCE OF TRIAL JUDGE PEIRSON M. HALL APPEARED BEFORE USDJ E. AVERY CRARY AND INTRODUCED A NEW

de

END PAGE ONE ALL INFORMATION CONTAINED
HEREIN IS UNCLASSIFIED *7/22/81 # 22,330* REC-4 92-3267-956
DATE 3/6/81 BY SP4 Jm/Kaa

22 APR 16 1968

6639 APR 19 1968

189

PAGE TWO

MOTION FOR PRE TRIAL DISCOVERY WHICH IS TO BE ARGUED BEFORE
JUDGE HALL APRIL FIFTEEN NEXT. CANTILLON'S NEW MOTION
FOR THE MOST PART CALLS FOR DISCOVERY OF NUMEROUS FORMS
OF EVIDENCE WHICH THE GOVERNMENT MIGHT HAVE BASED ON
ELECTRONIC SURVEILLANCES.

AUSA HANDLING ROSELLI'S CASE ADVISED THAT HE EXPECTS
THAT USDJ HALL WILL DENY THE MOTION ON THE SAME GROUNDS THAT
HE DENIED THE PRIOR MOTION AND ARGUE SAME AFTER TRIAL.

BUREAU WILL BE KEPT ADVISED OF DEVELOPMENTS.

END

LRC FBI WASH DC

VIA TELETYPE
APR 20 1968
ENCIPHERED

Mr. Tolson	_____
Mr. DeLoach	_____
Mr. Mohr	_____
Mr. Bishop	_____
Mr. Casper	_____
Mr. Callahan	_____
Mr. Conrad	_____
Mr. Felt	_____
Mr. Gale	_____
Mr. Rosen	_____
Mr. Sullivan	_____
Mr. Tavel	_____
Mr. Trotter	_____
Tele. Room	_____
Miss Holmes	_____
Miss Gandy	_____

ALL INFORMATION CONTAINED
HEREIN IS UNCLASSIFIED ^{7019#} ₂₂₁₃₃₀
DATE 3/6/81 BY 345 [signature]

WASH DC --2--
331PM URGENT 4-10-68 SMS
TO DIRECTOR (92-3267) ENCODE
FROM LOS ANGELES (92-113)

*CIA info unclassified per John E. Bacon 8/27/80

9 - [signature]
[signature]

also known as Anti-racketeering
JOHN ROSELLI, AKA. AR. OO-LA.
Office of Origin

AS BUREAU AWARE IN EARLY NINETEEN SIXTIES ROSELLI
CONTACTED BY CIA THROUGH ROBERT MAHEU AND REQUESTED TO
CONTACT SAM GIANCANA, FOR PURPOSE OF LEARNING SOME OF
GINACANA'S CONTACTS IN CUBA WHO COULD BE USED BY CIA.
ROSELLI HAS BEEN IN TOUCH WITH CIA OFFICIALS ON NUMEROUS
OCCASIONS SINCE. WITHIN PAST SEVERAL YEARS CIA OFFICIALS
ADVISED BUREAU ROSELLI NEVER AN EMPLOYEE CIA AND THEY WERE
CONCLUDING CONTACTS WITH HIM.

Assistant United States Attorney
AVSA DAVID R. NISSEN ADVISED TODAY JOHN KEENEY,
ASSISTANT IN CHARGE OF DEPARTMENT'S ORGANIZED CRIM SECTION,
TELEPHONICALLY ADVISED THAT CIA OFFICIAL HAD CONTACTED
DEPARTMENT OF JUSTICE WITH REQUEST INDICIMENT AGAINST

4/11/68
Keeneey denies
this well

END PAGE ONE

APR 19 1968

airtel to LA
4-11-68
AMS:J-1
59 APR 22 1968 39

[signature]

PAGE TWO

ROSELLI PERTAINING TO HIS ALIEN STATUS BE QUASHED BECAUSE
ROSELLI WAS CIA INFORMANT. KENNEY INFORMED NISSEN
DEPARTMENT OF JUSTICE ADVISED CIA THAT WHEN CIA FIRST
CONTACTED ROSELLI CIA KNEW HE WAS A HOODLUM FIGURE AND
DEPARTMENT OF JUSTICE WILL NOT TAKE ANY ACTION TO QUASH
CURRENT INDICTMENT AGAINST ROSELLI.

BUREAU REQUESTED ADVISE LA OF ANY ADDITIONAL INFO
OBTAINED CONCERNING ABOVE. U

END

MKP

FBI WASH DC

UNITED STATES GOVERNMENT

Memorandum

Tolson	_____
DeLoach	_____
Mohr	_____
Bishop	_____
Casper	_____
Callahan	_____
Conrad	_____
Felt	_____
Gale	_____
Rose	_____
Sullivan	_____
Tavel	_____
Trotter	_____
Tele. Room	_____
Holmes	_____
Gandy	_____

TO : Mr. DeLoach

DATE: April 12, 1968

FROM : J. H. Gale

**ALL INFORMATION CONTAINED
HEREIN IS UNCLASSIFIED**

DATE 3/6/81 BY SP4 Jm/...
**CIA info unclassified per
John E. Bacon 8/27/80*

SUBJECT: JOHN ROSELLI
also known as
ANTI-RACKETEERING

John Roselli is a West Coast hoodlum, a La Cosa Nostra member who represents the interest of the Chicago La Cosa Nostra "family" in that area. The Los Angeles Office has conducted extensive investigation with respect to his activities and those of a group of his hoodlum associates in cheating at cards at the Friars Club, Beverly Hills, California. As a result of FBI investigation, John Roselli now faces prosecution as an unregistered alien and also for violation of the Interstate Transportation in Aid of Racketeering - Gambling Statute.

It will be recalled in 1960 the Central Intelligence Agency (CIA) established a relationship with Roselli at which time the CIA had devised a plan to assassinate Fidel Castro through the utilization of the hoodlum element. The plan was never implemented.

The CIA has recently been in contact with the Department to alert the latter to meetings recently initiated by Roselli in Washington, D. C., with William Harvey, formerly of CIA who is now retired and practicing law in Washington, D. C. Harvey, when with CIA, was familiar with the relationship between Roselli and CIA. Department Attorney Keeney, Assistant in Charge of Department's Organized Crime Section, has telephonically briefed Assistant United States Attorney (AUSA) David R. Nissen of a former relationship between Roselli and CIA.

AUSA Nissen has requested our Los Angeles Office to determine through liaison all background in CIA files pertaining to Roselli; the identity of the individual or individuals representing CIA who actually handled contacts with Roselli. In view of the fact that AUSA Nissen has claimed to have gained the impression that efforts have been initiated by CIA to quash prosecution, AUSA Nissen requested contact with the Department for identity of individuals requesting such information. Nissen also desired information from CIA files which may bear on true

Enc. sent 4-15-68

1 - Mr. DeLoach

1 - Mr. Gale

1 - Mr. McAndrews

1 - Mr. Sullivan

1 - Mr. Bannon

APR 24 1968

PJB:kem (6)

CONTINUED - OVER

Memorandum to Mr. DeLoach
Re: John Roselli

identity of Roselli and, therefore, of pertinence to alien registration trial scheduled for April 23, 1968.

With respect to the current request of AUSA Nissen, the Los Angeles Office has been instructed to take no action pending receipt of Bureau instructions. u

CIA has stated that it has not in any way attempted to compromise this case and has no intention of doing so. Department Attorney Keeney has stated that the Department has been and is vigorously pressing for a prosecution of Roselli.

ACTION:

It would be inappropriate for the Bureau to solicit information from the CIA files with respect to the latter's relationship with Roselli. It is therefore, recommended that the attached airtel be forwarded to the Los Angeles Office instructing that AUSA Nissen be advised the Department is fully aware of the relationship which existed between Roselli and CIA, and further that Robert F. Kennedy, as Attorney General, was fully briefed by CIA after the CIA-Roselli relationship had been established. It should be tactfully suggested to AUSA Nissen that if he considers such information necessary, he obtain such through the Department of Justice.

1968

GR.
H
✓

✓
H
J
ghlan

VIA TELETYPE
APR 11 1968
ENCIPHERED

- Mr. Tolson _____
- Mr. DeLoach _____
- Mr. Mohr _____
- Mr. Bishop _____
- Mr. Casper _____
- Mr. Callahan _____
- Mr. Conrad _____
- Mr. Felt _____
- Mr. Gale _____
- Mr. Rosen _____
- Mr. Sullivan _____
- Mr. Tavel _____
- Mr. Trotter _____
- Tele. Room _____
- Miss Holmes _____
- Miss Gandy _____

WASH DC --4--

1123/441

1123 AM URGENT 4-11-68 ZMK SMS
TO DIRECTOR (92-3267) ENCODE
FROM LOS ANGELES (92-113)

*4/11 To Rose YF
advised to take no
action pending
review of FBI
instructions
MSP*

JOHN ROSELLI, AKA. AR, OO-LA.

RE LA TELS TO BUREAU MARCH FIFTEEN AND APRIL TEN
LAST; WFO AIRTEL TO BUREAU APRIL TWO LAST AND BUREAU
AIRTEL LA NOVEMBER SIX LAST. *u*

BY TEL DATED MARCH FIFTEEN LAST BUREAU WAS ADVISED
OF INFO PROVIDED BY [REDACTED]
THAT ROSELLI WAS GOING TO WASHINGTON, D.C. TO CONTACT
ATTORNEY AND HIGH POLITICAL FIGURES IN EFFORT TO FIX HIS ALIEN
INDICTMENT. *u*

ROSELLI HAS BEEN INDICTED FOR FAILURE TO REGISTER
AS ALIEN BY CONCEALING HIS TRUE IDENTITY AND FEDERAL TRIAL
IS SET LA APRIL TWENTY THREE NEXT. *u*

END PAGE ONE

APPROPRIATE AGENCIES
AND FIELD OFFICES
ADVISED BY ROUTING
SLIP(S) OF THIS MESSAGE
DATE 5/25/81 BY SP5 J/SK

*b2
b7D*

*4/12/68
memo sent to his touch
PJB: Rose
airtel to LA
PJB: shg
[Signature]*

LX-110

REC-21

APR 19 1968

TOP SECRET

Classified by 10049
Exempt from GDS, Category 2
Date of Declassification Indefinite

APR 22 1968 *39*

DECLASSIFIED BY *SP4 Jim/K...*
ON *3/6/81* *2029 # 22330*

**CIA Info declassified per
John E. Bacon 8/27/80*

PAGE TWO

WFO DETERMINED THAT ROSELLI WAS IN FACT IN WASHINGTON D.C. AT MADISON HOTEL BETWEEN DATES MARCH NINETEEN AND TWENTY THREE LAST AND WFO CONDUCTED INTERVIEW WHICH DETERMINE^{VE} ROSELLI WHILE IN WASHINGTON IN CONTACT WITH ROBERT MAHEU AND ATTORNEY EDWARD MORGAN. U

AS BUREAU AWARE ROBERT MAHEU PERSONAL ADMINISTRATIVE ASSISTANT TO HOWARD HUGHES AND IN EARLY NINETEEN SIXTIES WAS INDIVIDUAL WHO INTRODUCED ROSELLI TO CIA.

LA TEL OF APRIL TEN LAST SET FORTH INFO THAT CIA HAD APPROACHED DEPARTMENT OF JUSTICE REQUESTING THAT THE INDICTMENT OF ROSELLI BE QUASHED BECAUSE HE WAS CIA INFORMANT.

DEPARTMENT OF JUSTICE TELEPHONICALLY SUPPLIED THIS INFO TO USA LA WHO IS HANDLING ROSELLI TRIAL. U

TODAY AUSA DAVID R. NISSEN ADVISED HE IS CONCERNED RE THIS INFO, WAS NOT AWARE OF RELATIONSHIP BETWEEN ROSELLI AND CIA AND IS CONCERNED THAT DEFENSE MAY POSSIBLY UTILIZE THIS INFO TO ASSIST ROSELLI AT TIME OF TRIAL.

THEREFORE AUSA NISSEN HAS REQUESTED THE BUREAU THROUGH NORMAL LIAISON WASHINGTON DETERMINE THE FOLLOWING,
END PAGE TWO

~~TOP SECRET~~

PAGE THREE

THROUGH CONTACTS WITH CIA AND DEPARTMENT OF JUSTICE OFFICIALS.

ONE. ALL BACKGROUND IN CIA FILES PERTAINING TO ROSELLI.

TWO. THE IDENTITY OF THE INDIVIDUAL OR INDIVIDUALS REPRESENTING CIA WHO ACTUALLY HANDLED CONTACTS WITH ROSELLI.

THREE. THE IDENTITY OF THE INDIVIDUAL REPRESENTING CIA WHO CONTACTED DEPARTMENT OF JUSTICE OFFICIALS REQUESTING INDICTMENT BE QUASHED.

FOUR. THE IDENTITY OF THE INDIVIDUAL WHO REQUESTED THAT HE DO THIS. *u*

FIVE. ANY INFORMATION IN POSSESSION OF ANY CIA PERSONNEL OR FILES HAVING BEARING ON THE TRUE IDENTITY OF ROSELLI AND OF PERTINENCE TO THE TRIAL TO BEGIN APRIL TWENTY THREE NEXT.

BUREAU REFER TO YOUR AIRTEL TO LA NOVEMBER SIX LAST WHEREIN INFO IS SET FORTH THAT ROSELLI IN CONVERSATION WITH FORMER CIA EMPLOYEE COLONEL SHEFFIELD EDWARDS ADVISED THAT HE HAD BEEN CONTACTED BY THE FBI CONCERNING HIS TRUE IDENTITY. *X (u)*

END PAGE THREE

~~TOP SECRET~~

PAGE FOUR

CIA REQUESTED THAT BUREAU NOT DISSEMINATE THIS
INFO BECAUSE ROSELLI'S CONTACT WITH CIA EXTREMELY SENSITIVE AND
COULD BE HARMFUL TO NATIONAL SECURITY INTERESTS. ~~XS~~(u)

IN VIEW OF CIA'S ADMISSION TO DEPARTMENT OF
JUSTICE OF RELATIONSHIP BETWEEN ROSELLI AND THEIR AGENCY
BUREAU IS REQUESTED TO RECONSIDER THIS RESTRICTION SO
USA, LA CAN BE AGISSD AS TO IDENTITY OF SHEFFIELD EDWARDS
FOR HIS CONSIDERATION IF EDWARDS COULD BE A PERTINENT
WITNESS TO THE PROSECUTION OF ROSELLI.

END

HWL

FBI WASH DC

TOP SECRET

UNITED STATES GOVERNMENT

Memorandum

Tolson	_____
DeLoach	_____
Mohr	_____
Bishop	_____
Casper	_____
Callahan	_____
Conrad	_____
Felt	_____
Gale	_____
Rosen	_____
Sullivan	_____
Tavel	_____
Trotter	_____
Tele. Room	_____
Holmes	_____
Gandy	_____

TO : Mr. D. J. Brennan, Jr. *HJB*

DATE: June 28, 1968

FROM : S. J. Papich *SP*

SUBJECT: JOHN ROSELLI, Also Known As
AR

Howard Osborn, Director of Security, Central Intelligence Agency (CIA), furnished the following to the Liaison Agent on June 26, 1968:

About 1:30 p.m., June 26, 1968, [redacted] who has a questionable background, telephonically contacted [redacted], CIA. It should be noted that [redacted] was privy to some aspects of the intelligence operation which involved CIA and the subject. [redacted] met [redacted] At that time, Maheu was involved in the CIA operation [redacted] has not seen or been in contact with [redacted] since the meeting [redacted]

[redacted] told [redacted] on June 26, 1968, that he had been in touch with the subject, and the subject was interested in determining how contact could be established with [redacted] [redacted] did not elaborate further. [redacted] told him that he could not understand why such a question was raised because his name is in the local Washington telephone directory. [redacted] did not make any further comment.

[redacted] volunteered that he had seen the subject in [redacted] a couple of months ago. He stated that Roselli had been "pushed pretty hard by the Bureau" but was holding up quite well. He further volunteered that he had seen Roselli a few weeks ago at the [redacted] Also present was the subject's attorney, [redacted]

Osborn advised that [redacted] has received clear-cut instructions not to get involved with [redacted] or Roselli under any circumstances. Osborn admitted that CIA is disturbed over the [redacted] call because the purpose very definitely is not spelled out.

ALL INFORMATION CONTAINED

HEREIN IS UNCLASSIFIED

DATE 3/5/81 BY 504-gmk/ea

*CIA info unclass per John E. Bacon 8/27/80

22 JUL 2 1968

CONTINUED

- 1 - Mr. McAndrews
- 1 - Liaison
- 1 - Mr. Papich

SJP:clb
(4)

57 JUL 11 1968

360

M
NINE

b3 per CIA

b7c

McAndrews

Osborn

Maheu

E

Memorandum S. J. Papich to Mr. D. J. Brennan, Jr.
RE: JOHN ROSELLI, Also Known As
AR

ACTION:

The above information is being directed to the
attention of the Criminal Intelligence and Organized Crime
Section of the Special Investigative Division. 4

[Handwritten signature]

UNITED STATES GOVERNMENT

Memorandum

Tolson	_____
DeLoach	_____
Mohr	_____
Bishop	_____
Casper	_____
Callahan	_____
Conrad	_____
Felt	_____
Gale	_____
Rosen	_____
Sullivan	_____
Tavel	_____
Trotter	_____
Tele. Room	_____
Holmes	_____
Gandy	_____

TO : Mr. D. J. Brennan, Jr. *DB*

DATE: December 27, 1968

FROM : W. O. Cregar *WOC*

SUBJECT: JOHN ROSELLI
ANTI-RACKETEERING

7/24 9- STopped in [unclear] [unclear]

Howard Osborn, Director of Security, Central Intelligence Agency (CIA), furnished the following to the Liaison Agent on December 27, 1968:

b3 per CIA

At about 2 p.m. on the afternoon of December 26, 1968, [redacted] Office of Security, CIA, received a telephone call from subject, who indicated he was at Washington National Airport having just arrived there from Florida. Roselli indicated he planned to contact Ed Morgan (former Bureau Agent and currently practicing law in Washington, D.C.) to discuss several appeals he desired Morgan to make. Following Roselli's conversation with Morgan, he expected to enplane for Newark, New Jersey, where he hoped to visit some friends.

b3 per CIA

The purpose of Roselli's call to [redacted] was to wish him a Merry Christmas and a Happy New Year.

The above information was telephonically furnished Supervisor Emery of the Criminal Intelligence and Organized Crime Section by the Liaison Agent.

ACTION:

The above information is being directed to the attention of the Criminal Intelligence and Organized Crime Section of the Special Investigative Division for its information. *u*

- 1 - A. A. Staffeld
- 1 - Liaison
- 1 - W. O. Cregar

REC-19 72-3767-1011

10 JAN 2 1969

WOC:clb
(4)

ALL INFORMATION CONTAINED

HEREIN IS UNCLASSIFIED *7019A#22,330*

DATE *3/5/81* **BY** *SP4-jm/kca*

**CIA info unclassified per John E. Bacon 8/27/80*

PERP. REC. UNIT

9 JAN 30 1969
671

CORRELATION SUMMARY

Main File No: 92-3267
See also: 58-2000
60-2149
63-126
92-9290
137-7907
166-3200

Date: 10/30/70

ALL INFORMATION CONTAINED

HEREIN IS UNCLASSIFIED

702 Pkt 22,330

DATE 3/5/81 BY SP4-*Qmm/Koa*

*CIA info unclassified per John E. Bacon 8/27/80

Subject: John Roselli
John Russell*
James Stewart*

Date Searched: 4/9/69

All logical variations of subject's name and aliases were searched and identical references were found as set out on page 2:

This is a summary of information obtained from a review of all "see" references to the subject in Bureau files under the names and aliases listed on page 2. All references under these names containing data identical with the subject have been included except any indicated at the end of this summary under the heading REFERENCES NOT INCLUDED IN THIS SUMMARY. References indicated in the block as SI contain the same information as the foregoing serial although the information may have been received from a different source.

THIS SUMMARY HAS BEEN PREPARED FOR USE AT THE SEAT OF GOVERNMENT AND IS NOT SUITABLE FOR DISSEMINATION. IT IS DESIGNED TO FURNISH A SYNOPSIS OF THE INFORMATION SET OUT IN EACH REFERENCE, AND IN MANY CASES THE ORIGINAL SERIAL WILL CONTAIN THE INFORMATION IN MORE DETAIL.

Analyst

Coordinator

Approved

[Redacted]

[Redacted]

[Redacted]

EBM
EBM:eco

MCI QSA *mcg/gt* *REC-3A*

92-3267-1037

*Not completely searched. See page 83 on search slip.

NO NOV 21 1970

1-ENCLOSURE

Enclosure Behind File - Search Slips Only

57 NOV 23 1970

529

CONFIDENTIAL

(continued)

REFERENCE

SEARCH SLIP PAGE NUMBER

[REDACTED]

~~(24)~~
~~(48)~~
~~(28)~~
~~(46)~~
~~(24)~~
~~(49)~~

~~(49)~~

b3
b7D
b7C
US

[REDACTED]

The following reference in the file captioned "Arthur James Balletti" indicated that John Roselli was possibly involved with Balletti in surveilling and recording telephone conversations of Dan Rowan, one of the partners in the Rowan and Martin comedy team at the Riviera Hotel in Las Vegas, Nevada, in October 1960. During the time Balletti proceeded to Las Vegas to surveil Rowan, Roselli was registered at the Kenilworth Hotel in Miami. Roselli was uncorporative regarding an interview with the SAs in Los Angeles, on 7/19/61. Background data was also set out.

REFERENCE

SEARCH SLIP PAGE NUMBER

139-1201-28 encl. p.2-5
-30
-31
-49 p.1-3
-69 p.1-6

~~(25, 57, 49, 56, 57, 58, 70, 81)~~
~~(73)~~
~~(73, 58)~~
~~(25, 49)~~
~~(25)~~

(continued)

INDIVIDUAL

REFERENCE

SEARCH SLIP
PAGE NUMBER

[REDACTED]	[REDACTED]	(25)
[REDACTED]	[REDACTED]	(42)
[REDACTED]	[REDACTED]	(16)

12
17C
b7D
OS

[REDACTED] California on [REDACTED] advised that he had known John Roselli for about [REDACTED] years, having met him in the late [REDACTED]

[REDACTED] Roselli was in the motion picture business. He said that Roselli was not a good card player and played with the poorer players at the Friar's Club. He had heard that Roselli handled the distribution of all playing cards to the casinos in Nevada.

[REDACTED]

The following references on John Roselli appear in the file captioned "Assassination of President John F. Kennedy". These references set forth an interview of Attorney Edward Morgan of Washington, DC on 3/20/67 concerning alleged information in his possession regarding the assassination. Roselli was the connecting link between CIA and Robert Mahen who allegedly was hired by the CIA to approach Sam Giancana, hoodlum, to have Fidel Castro, Premier of Cuba, assassinated. Castro learned of the plot, and thereafter, dispatched a team of assassins to the US for the purpose of assassinating President Kennedy. On 5/9/67, Ed Reid, a former newspaperman from Las Vegas, indicated he had information concerning Roselli and wanted to trade it for the above information on Roselli.

REFERENCE

SEARCH SLIP PAGE NUMBER

62-109060-4984 encl. p.4
-5589 p.2

(14)
(14)

FBI

Date: 3/2/71

Transmit the following in _____
(Type in plaintext or code)

Via AIRTEL AIR MAIL
(Priority)

TO: DIRECTOR, FBI (92-3267)
FROM: SAC, LOS ANGELES (92-113)
RE: JOHN ROSELLI, aka
AR
OO: Los Angeles

Re Los Angeles teletype, 1/25/71.

As Bureau is aware, JOHN ROSELLI presently serving six months in custody of the Attorney General as a result of conviction in U.S. District Court, Los Angeles, in FBI handled alien case and five years in custody of the Attorney General as a result of his conviction in Los Angeles in the Friars Club case. ROSELLI presently incarcerated McNeil Island Penitentiary.

ROSELLI's attorney, ADRIAN MARSELL, accompanied by Attorney TOM WADDEN, appeared before U.S. District Judge PIERSON M. HALL, U.S. District Court, Los Angeles, on 3/1/71, in an effort to obtain a hearing date for a modification of sentence for ROSELLI based on a series of articles written by syndicated columnist JACK ANDERSON. These articles allege that JOHN ROSELLI was involved with the CIA in clandestine operations involving Cuba.

U.S. District Judge HALL, who sentenced ROSELLI in the alien case, denied the hearing date and commented that even if the articles were true they would have no effect on his sentence and he would not alter the sentence.

The above is for the information of the Bureau.

2 Bureau
2 Los Angeles

WHR/jmb
(4)

REC-30 92-3267-1042

MAR 5 1971

5 MAR 16 1971

Sent _____ M Per _____

Special Agent in Charge

FEDERAL BUREAU OF INVESTIGATION

REPORTING OFFICE LOS ANGELES	OFFICE OF ORIGIN LOS ANGELES	DATE 3/17/71	INVESTIGATIVE PERIOD 1/11/71 - 3/10/71
TITLE OF CASE JOHN ROSELLI, AKA.		REPORT MADE BY [REDACTED] b7C	TYPED BY fsc
		CHARACTER OF CASE AR	

REFERENCE: Report of SA **[REDACTED]** dated 11/27/70, at Los Angeles. *u*

- P -

ADMINISTRATIVE

This case is being maintained in a current status in the Los Angeles Office even though ROSELLI is presently incarcerated at Mac Neil Island Penitentiary. *u*

The Seattle Office is being requested by separate cover to monitor the activities of ROSELLI while at Mac Neil Island. In addition, ADRIAN MARSHALL, the attorney for JOHN ROSELLI, plans to request U. S. District Judge GRAY for a reduction in sentence based on ROSELLI's connections with the CIA. *u*

ACCOMPLISHMENTS CLAIMED					<input checked="" type="checkbox"/> NONE	ACQUIT-TALS	CASE HAS BEEN:
CONVIC.	AUTO.	FUG.	FINES	SAVINGS	RECOVERIES		
							PENDING PROSECUTION OVER SIX MONTHS <input type="checkbox"/> YES <input checked="" type="checkbox"/> NO

APPROVED *[Signature]* SPECIAL AGENT IN CHARGE

DO NOT WRITE IN SPACES BELOW

COPIES MADE:
 3 - Bureau (92-3267)
 2 - USA, Los Angeles
 (1 - Special Prosecutions Section)
 (1 - ALFRED N. KING, AIC, Strike Force, Los Angeles)
 2 - Los Angeles (92-113)

92-3267-11043 REC-78

MAR 29 1971

EX-112

[Handwritten marks]

Dissemination Record of Attached Report

Agency	CR. DIV. Criminal Division
Request Recd.	Organized Crime and Racketeering
Date Fwd.	3/17/71
How Fwd.	By F-211 [Signature]

Notations

SECT.

70 APR 21 1971

COVER PAGE *1090*

LA 92-113

Judge GRAY had previously sentenced ROSELLI to five years in custody of the Attorney General as a result of this conviction in the Friars Club case. u

LEADS

LOS ANGELES

AT LOS ANGELES, CALIFORNIA: (1) Will continue to follow and report activities of JOHN ROSELLI while at Mac Neil Island Penitentiary. u

(2) Will continue to follow and report the activities of ROSELLI's attorney in an effort to have ROSELLI released from prison. u

UNITED STATES DEPARTMENT OF JUSTICE
FEDERAL BUREAU OF INVESTIGATION

Copy to: 2 - USA, Los Angeles
(1 - Special Prosecutions Section)
(1 - ALFRED N. KING, AIC, Strike Force, Los Angeles)

Report of: [REDACTED] b7c
Date: 3/17/71

Field Office File #: 92-113
Title: JOHN ROSELLI

Office: Los Angeles, California
Bureau File #: 92-367

Character: ANTI-RACKETEERING

Synopsis: ROSELLI surrendered USM, Los Angeles, 1/25/71, to begin sentence of six months which he received in Alien matter, USDC, Los Angeles, and the five-year sentence he received as a result of conviction in the Friars Club case. On 3/1/71, ROSELLI's attorney appeared before USDJ, Los Angeles, in an effort to obtain a hearing date for modification of sentence based on a series of articles written by JACK ANDERSON alleging ROSELLI was involved with CIA in clandestine operations involving Cuba. ANDERSON's affidavit set forth. Judge HALL denied a hearing date. u

- P -

DETAILS:

On January 18, 1971, ROSELLI appeared before U. S. District Judge PEIRSON M. HALL, at which time, the mandate of the Ninth Circuit Court of Appeals was ordered spread by Judge HALL on the conviction of ROSELLI in an Alien case in U. S. District Court. ROSELLI had received a six month sentence. ROSELLI was ordered to the custody of the U. S. Marshal immediately to begin serving the sentence, and ROSELLI was taken into the custody of the U. S. Marshal. u

LA 92-113

Assistant U. S. Attorney DAVID R. NISSEN, U. S. Attorney's Office, Los Angeles, advised on January 20, 1971, that subsequent to ROSELLI being turned over to the U. S. Marshal, and subsequent to NISSEN's departure from the courtroom, JAMES P. CANTILLON, one of ROSELLI's attorneys, requested an appearance before Judge HALL, which was granted. Notice was not given the U. S. Attorney's Office of this appearance and no one appeared to represent the Government. Mr. NISSEN said that he learned the above on January 20, 1971, from Judge HALL's Secretary who further advised that CANTILLON requested a stay for ROSELLI until 12:00 noon on Monday, January 25, 1971, and also requested Judge HALL allow ROSELLI to serve his sentence at Federal Correctional Institution, Terminal Island, California. According to Mr. NISSEN, Judge HALL granted CANTILLON's request without a representative of the U. S. Government being present. Assistant U. S. Attorney NISSEN stated that he had been in contact with the U. S. Marshal's Office, Los Angeles, and Mac Neil Island Penitentiary had been designated as the place of incarceration for ROSELLI. U

On January 25, 1971, ROSELLI surrendered to the U. S. Marshal, Los Angeles, to begin serving six month and five years sentences as a result of his convictions, in an Alien case and the Friars Club case. U

On January 25, 1971, U. S. District Judge WILLIAM P. GRAY, U. S. District Court, Los Angeles, spread the mandate of the Ninth Circuit Court of Appeals in the Friars Club case. U

On March 1, 1971, ADRIAN MARSHALL and TOM WADDEN, Attorneys for JOHN ROSELLI, appeared before U. S. District Judge PEIRSON M. HALL in an effort to obtain a hearing date for a modification of sentence for ROSELLI based on a series of articles written by syndicated columnist JACK ANDERSON. These articles alleged that JOHN ROSELLI

LA 92-113

was involved with the CIA in clandestine operations involving Cuba. U. S. District Judge HALL denied the hearing date, and commented that even if the articles were true, that it would have no effect on his sentence, and he would not alter the sentence. The affidavits of JACK ANDERSON are as follows: u

1
2
3
4
5
6
7
8
9
10
11
12
13
14
15
16
17
18
19
20
21
22
23
24
25
26
27
28
29
30
31
32

ADRIAN MARSHALL
WADDEN, WALL & RUDY
9601 Wilshire Boulevard, Suite 400
Beverly Hills, California 90210
272 - 9211
Attorneys for Defendant

lnf

UNITED STATES DISTRICT COURT
CENTRAL DISTRICT OF CALIFORNIA

UNITED STATES OF AMERICA,)
)
)
Plaintiff,)
)
vs.)
)
FILIPPO SACCO, also known)
as JOHN ROSSELLI,)
)
Defendant.)

NO. 1175 - PH
AFFIDAVITS OF JACK ANDERSON
AND LESLIE WHITTEN
IN SUPPORT OF MOTION FOR
REDUCTION OF SENTENCE
AND REQUEST FOR EVIDENTIARY
HEARING.

SEP 30 1977
XEROXED ORIGINAL-RETRACED
145

IN THE UNITED STATES DISTRICT COURT
CENTRAL DISTRICT OF CALIFORNIA

UNITED STATES OF AMERICA,
Plaintiff-Appellee,
v.
JOHN ROSSELLI
(aka FILIPPO SACCO),
Defendant-Appellant.

No. 1175 - PH

AFFIDAVIT IN SUPPORT OF MOTION
FOR REDUCTION OF SENTENCE
AND REQUEST FOR EVIDENTIARY HEARING

CITY OF WASHINGTON)
DISTRICT OF COLUMBIA) ss.

JACK ANDERSON, being duly sworn, deposes and says
the following:

1. I am a nationally syndicated columnist writing
under my own by-line. For many years prior to the death of
Mr. Drew Pearson, he and I wrote a column known as the
"Washington Merry-Go-Round".

2. I wrote the articles attached hereto as Exhibits
A and B pertaining to certain activities performed by
John Rosselli, the Defendant herein, on behalf of the
United States Government.

3. The information contained in said articles was
made available to me by persons employed by the United States
Government who, in the past, have supplied me with accurate
and truthful information as pertains to other subjects.

4. After receiving said basic information, my staff
and I conducted an impartial and independent investigation
regarding John Rosselli's activities as described in Exhibit A,
which were performed at the behest of Agents of the United
States Government.

5. The aforementioned investigation satisfied me that the facts set forth in Exhibit A are a truthful account of Mr. Rosselli's activities as described therein.

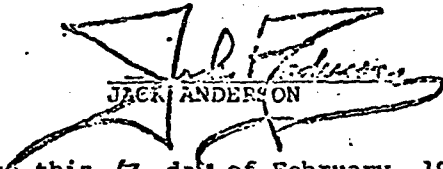
JACK ANDERSON

Sworn to before me this 17 day of February, 1971.

NOTARY PUBLIC

My Commission Expires Nov. 14, 1971

IN THE UNITED STATES DISTRICT COURT
CENTRAL DISTRICT OF CALIFORNIA

UNITED STATES OF AMERICA,)
)
Plaintiff-Appellee,)
)
v.)
)
JOHN ROSSELLI)
(aka FILIPPO SACCO),)
)
Defendant-Appellant)

No. .1175 - PH

AFFIDAVIT IN SUPPORT OF MOTION
FOR REDUCTION OF SENTENCE
AND REQUEST FOR EVIDENTIARY HEARING

CITY OF WASHINGTON)
) ss.
DISTRICT OF COLUMBIA)

LESLIE WHITTEN, being duly sworn, deposes and says the following:

1. I am employed as principal associate of nationally-syndicated columnist Jack Anderson, writer of "Washington Merry-Go-Round."
2. I worked on certain articles relating to John Rosselli, and services performed by him on behalf of the Central Intelligence Agency, an organ of the United States Federal government.
3. As part of my investigation, I twice called William K. Harvey, a retired Central Intelligence Agency official, now of Indianapolis.
4. On my first call, in January, I asked Harvey if it were not true that he had personally intervened with the Justice Department in order to mitigate the government's prosecution of Roselli on the basis that Roselli had done a formidable service for his country. Harvey said "this is a long story...I don't think it ought to be printed." I asked him whether it was not true that he had a high regard for Rosselli. "I still do," he earnestly replied.
5. In pursuing the story further, I called Harvey again in Indianapolis this date (February 17, 1971) and asked him whether he could comment on our story about Rosselli which by now has been published widely in the United States. He declined to comment. But

he twice reaffirmed his "high regard" for Rosselli. I advised him I was making an affidavit on Rosselli's behalf and he expressed concern for Rosselli, asked his present status and said he would "follow up" on Rosselli's behalf from his end.

6. Based on my part of the investigation, I am satisfied that the facts set down in Exhibit A, appended to the Affidavit of Jack Anderson, are a truthful account of Rosselli's activities on behalf of the United States.

Leslie Whitten

LESLIE WHITTEN

Sworn to before me this 17 day of February, 1971.

[Signature]

NOTARY PUBLIC

NY Notar Public Expires Nov. 14, 1971

Jackerson Merry-Go-Round

6 CIA ATTEMPTS TO ASSASSINATE CASTRO REVEALED BY ANDERSON;
HUGHES AIDE MAHEU & JUNE LANG'S EX FIGURED IN HUSHED PLOT;
QUESTION: DID CASTRO GET OSWALD TO KILL KENNEDY IN REVENGE?

By Jack Anderson

(Copyright © 1971 by Bell-McClure Syndicate)

WASHINGTON--Locked in the darkest recesses of the Central Intelligence Agency is the story of six assassination attempts against Cuba's Fidel Castro.

For 10 years, only a few key people have known the terrible secret. They have sworn never to talk. Yet we have learned the details from sources whose credentials are beyond question.

The plot to knock off Castro began as part of the Bay of Pigs operation. The intent was to eliminate the Cuban dictator before the motley invaders landed on the island. Their arrival was expected to touch off a general uprising, which the communist militia would have had more trouble putting down without the charismatic Castro to lead them.

After the first attempt failed, five more assassination teams were sent to Cuba. The last team reportedly made it to a rooftop within shooting distance of Castro before members were apprehended. This happened around the last of February or first of March, 1963.

Nine months later, President Kennedy was gunned down in Dallas by Lee Harvey Oswald, a fanatic who previously had agitated for Castro in New Orleans and had made a mysterious trip to the Cuban Embassy in Mexico City.

Among those privy to the CIA conspiracy, there is still a nagging suspicion--unsupported by the Warren Commission's findings--that Castro became aware of the U.S. plot upon his life and somehow recruited Oswald to retaliate against President Kennedy.

To set up the Castro assassination, the CIA enlisted Robert Maheu, a former FBI agent with shadowy contacts, who had handled other undercover assignments for the CIA out of his Washington public relations office. He later moved to Las Vegas to head up billionaire Howard Hughes's Nevada operations.

Once, a Cuban patrol boat sank Roselli's boat with a lucky shot but the occupants were quickly fished out of the murky water by the other boat. The assassination teams never got a shot at Castro, although the last group reached a rooftop within range. No doubt most of the infiltrators were picked up and tortured terribly.

Roselli, Harvey, O'Connell and company had taken precautions, however, to make sure not even the Cuban recruits knew the CIA was behind the plot. Roselli posed as a representative of big oil interests which sought revenge against Castro expropriating their holdings in Cuba. The weapons and other equipment were of foreign make, mostly Belgian, to prevent any link to the U.S.

All the equipment, including the two powerboats, were purchased out of Roselli's own pocket. The CIA paid only the expenses of its two agents Harvey and O'Connell.

--NO COMMENT--

The principals in the CIA conspiracy, sworn to deep secrecy, refused to comment on the caper. We got an admission out of Maheu only that he had handled special jobs for the CIA, but he refused to discuss them. Roselli responded with a flat "no comment."

My associate Les Whitten located Harvey, who left the CIA about two years ago, in Indianapolis. Asked about Roselli, Harvey said he had a high regard for him. Whitten then questioned Harvey about Roselli's daring work.

"This is a long story," replied the former CIA man, "I don't think it ought to be printed." Thereafter, he refused to acknowledge even that he had been a CIA operative.

We got an admission from "Big Jim" O'Connell, who is still with the CIA, that he had met Roselli through Maheu. But when we asked about Roselli's CIA mission, O'Connell also blammed up.

Finally we spoke to John McCone, who headed the CIA at the time of the assassination attempts. He acknowledged the idea had been discussed inside the CIA but insisted it had been "rejected immediately." He vigorously denied that the CIA had ever participated in any plot on Castro's life. Asked whether the attempts could have been made without his knowledge, he replied "It could not have happened."

... have complete confidence, however, in our sources.

Maheu recruited John Roselli, a ruggedly handsome gambler with contacts in both the American and Cuban underworlds, to arrange the assassination. The dapper, hawk-faced Roselli, formerly married to movie actress June Lang, was a power in the movie industry until his conviction with racketeer Willie Bioff in a million-dollar Hollywood labor shakedown.

The CIA assigned two of its most trusted operatives, William Harvey and James "Big Jim" O'Connell, to the hush-hush murder mission. Using phony names, they accompanied Roselli on trips to Miami to line up the assassination teams.

The full story reads like the script of a James Bond movie, complete with secret trysts at glittering Miami Beach hotels and midnight powerboat dashes to secret landing spots on the Cuban coast. Once, Roselli's boat was shot out from under him.

For the first try, the CIA furnished Roselli with special poison capsules to slip into Castro's food. The poison was supposed to take three days to act. By the time Castro died, his system would throw off all traces of the poison, so he would appear to be the victim of a natural or mysterious ailment.

Roselli arranged with a Cuban, related to one of Castro's chefs, to plant the deadly pellets in the dictator's food. On March 13, 1961, Roselli delivered the capsules to his contact at Miami Beach's glamorous Fontainebleau Hotel.

A couple weeks later, just about the right time for the plot to have been carried out, a report out of Havana said Castro was ill. But he recovered before the Bay of Pigs invasion on April 17, 1961.

--WAS CASTRO POISONED?--

The Cuban who had sneaked the poison into Havana was never seen again. The CIA, unsure whether the plotters had failed or the poison simply hadn't been strong enough, decided to try again with a more powerful dose. Roselli arranged for triple-strength capsules to be slipped into Castro's food several weeks after the Bay of Pigs. But once again, the plot failed and the conspirators disappeared. 11

Four more attempts were made on Castro's life, using Cuban assassination teams equipped with high-powered rifles, explosives and two-way radios. At intervals in the dark of night, Roselli personally delivered the teams in twin powerboats to the Cuban shores. (more)

Jack Anderson Merry-Go-Round

DID PRESIDENT KENNEDY KNOW ABOUT CASTRO ASSASSINATION PLOT?

HE SAID HE'D LIKE TO "SPLINTER CIA INTO A THOUSAND PIECES";

DID CIA PLOT ASSASSINATIONS OF TRUJILLO AND NGO DINH DIEM?

Copyright © 1971 by Bell-McClure Syndicate

By Jack Anderson

WASHINGTON--The plot to kill Cuban dictator Fidel Castro, hidden for 10 years from the public, raises some ugly questions that high officials would rather keep buried deep inside the Central Intelligence Agency.

1. Has the CIA tried to assassinate any other leaders? John McCone, who headed the CIA during the six attempts to knock off Castro, denied emphatically that the CIA has tried to kill anyone. But ex-Senator George Smathers, one of John F. Kennedy's closest friends, told us the late President suspected that the CIA had arranged the shootings of the Dominican Republic's Rafael Trujillo in 1961 and South Vietnam's Ngo Dinh Diem in 1963.

2. Did President Kennedy personally sanction the plot against Castro? The preparations to assassinate the Cuban dictator began during the last months of the Eisenhower administration as part of the Bay of Pigs scheme. All six attempts, however, were made during 1961-63 when Kennedy occupied the White House. Smathers told us he once spoke to the late President about assassinating Castro. Kennedy merely rolled back his eyes, recalled Smathers, as if to indicate the idea was too wild to discuss. Subsequently, Kennedy told Smathers of his suspicion that the CIA may have been behind the Trujillo and Diem assassinations.

3. Did the late Robert Kennedy know about the assassination attempts? After the Bay of Pigs fiasco, President Kennedy swore to friends he would like "to splinter the CIA in a thousand pieces and scatter it to the winds." He put his brother, Robert, in charge of the CIA with instructions to shake it up. The CIA made five attempts on Castro's life after the Bay of Pigs while Robert Kennedy was riding herd on the agency.

4. Could the plot against Castro have backfired against President Kennedy? The late President was murdered nine months after the last assassination team was caught on a Havana rooftop with high-powered rifles. Presumably, they were subjected to fiendish tortures until they told all they knew. None of the assassination teams, however, had direct knowledge of the CIA involvement. The CIA instigators had represented themselves as oilmen seeking revenge against Castro for his seizure of oil holdings.

--DID PLOT BACKFIRE?--

Former associates recall that Robert Kennedy, deeply despondent, went into semi-seclusion after his brother's assassination. Could he have been tormented by more than natural grief? He certainly learned that the assassin, Lee Harvey Oswald, had been active in the pro-Castro movement and had traveled to Mexico to visit the Cuban Embassy a few weeks before the dreadful day in Dallas. Could Bob Kennedy have been plagued by the terrible thought that the CIA plot, which he must at least have condoned, put into motion forces that may have brought about his brother's martyrdom?

The last surviving brother, Senator Ted Kennedy, D-Mass., could give us no insight. His brothers had never spoken to him about any assassination attempts against Castro, he said. He was aware, he volunteered, only that Senator Smathers had talked to the late President about eliminating Castro.

Smathers told us that President Kennedy seemed "horrified" at the idea of political assassinations. "I remember him saying," recalled Smathers, "that the CIA frequently did things he didn't know about, and he was unhappy about it. He complained that the CIA was almost autonomous.

"He told me he believed the CIA had arranged to have Diem and Trujillo bumped off. He was pretty well shocked about that. He thought it was a stupid thing to do, and he wanted to get control of what the CIA was doing."

But McCone, disagreeing vigorously, told us that "no plot was authorized or implemented" to assassinate Castro, Trujillo, Diem or anyone else.

--MCCONE'S RECOLLECTIONS--

"During those days of tension, there was a wide spectrum of plans ranging from one extreme to another," McCone admitted. "Whenever this subject (assassinating Castro) was brought up--and it was--it was rejected immediately on two grounds. First, it would not be condoned by anybody. Second, it wouldn't have achieved anything."

There was also talk in high places, McCone acknowledged, of supporting a coup to oust Diem. The former CIA director said he had argued against this at a secret session with both Kennedy brothers. He had contended that there was no one strong enough to take Diem's place and that a coup, therefore, would bring "political upheaval."

"I told the President and Bobby together," recalled McCone, "that if I were running a baseball team and had only one pitcher, I wouldn't take him out of the game."

The November, 1963, coup caught the U.S. completely by surprise, he said. While the plotters were moving on the palace, he said, then-Ambassador Henry Cabot Lodge was visiting Diem. Admiral Ulysess Sharp, then our Pacific commander, had also been present, but had left early to go to the airport.

McCone said President Diem escaped through a tunnel but was caught in nearby Cholon and "shot in a station wagon."

--STEEL PRESSURE--

President Nixon jolted the steel industry with his threat to import foreign steel, if necessary, to drive down steel prices. His tough statement was intended, in part, as a precedent for bringing presidential pressure upon the steel workers.

They will set the pattern for more than five million workers whose contracts will be renegotiated this year. The steel workers union will negotiate for 400,000 workers in the steel industry and another 250,000 in aluminum, can, copper and other non-ferrous industries. At least half a dozen other big unions will be watching the steel workers' settlement before they press their own demands.

A new round of wage increases could send the economy into another inflationary spiral. The President, therefore, is eager to hold off the steel workers' pay raise. He could hardly oppose a wage increase

...of opinion, ... was a wide spectrum of plan:
... from one extreme to another," McCone admitted. "Whenever
this subject (assassinating Castro) was brought up--and it was--it
was rejected immediately on two grounds. First, it would not be condoned
by anyone. Second, it wouldn't have achieved anything."

... also talk in high places, McCone acknowledged, of
... a coup to oust Diem. The former CIA director said he had
argued against this at a secret session with both Kennedy brothers.
He had contended that there was no one strong enough to take Diem's
place and that a coup, therefore, would bring "political upheaval."

"I told the President and Bobby together," recalled McCone, "that
if I were running a baseball team and had only one pitcher, I wouldn't
take him out of the game."

The November, 1963, coup caught the U.S. completely by surprise,
he said. While the plotters were moving on the palace, he said,
then-Ambassador Henry Cabot Lodge was visiting Diem. Admiral Ulysess
Sharp, then our Pacific commander, had also been present, but had left
early to go to the airport.

McCone said President Diem escaped through a tunnel but was caught
in nearby Cholon and "shot in a station wagon."

--STEEL PRESSURE--

President Nixon jolted the steel industry with his threat to import
foreign steel, if necessary, to drive down steel prices. His tough
statement was intended, in part, as a precedent for bringing
presidential pressure upon the steel workers.

They will set the pattern for more than five million workers whose
contracts will be renegotiated this year. The steel workers union will
negotiate for 400,000 workers in the steel industry and another
250,000 in aluminum, can, copper and other non-ferrous industries. At
least half a dozen other big unions will be watching the steel workers'
settlement before they press their own demands.

A new round of wage increases could send the economy into another
inflationary spiral. The President, therefore, is eager to hold down
the steel workers' pay raise. He could hardly oppose a wage increase,

however, if he acquiesced to a price increase by the steel companies.
In the past, President Nixon has been reluctant to use his office
to pressure labor and management to accept more moderate settlements.
The inflation threat is so serious, however, that he is now changing
his attitude. But, he still will not go so far as to press for wage
and price controls.

1
2
3
4
5
6
7
8
9
10
11
12
13
14
15
16
17
18
19
20
21
22
23
24
25
26
27
28
29
30
31
32

(VERIFICATION -- 416, 20155 C. C. P.)

STATE OF CALIFORNIA
COUNTY OF }

I am the _____

in the above entitled action; I have read the foregoing _____

and know the contents thereof; and I certify that the same is true of my own knowledge, except as to those matters which are therein stated upon my information or belief, and as to those matters I believe it to be true.

I certify (or declare), under penalty of perjury,* that the foregoing is true and correct.

Executed on _____ at _____ California

(date)

(place)

Signature

(PROOF OF SERVICE BY MAIL -- 1013a, 20155 C. C. P.)

STATE OF CALIFORNIA
COUNTY OF Los Angeles }

I am a citizen of the United States and a resident of the county aforesaid; I am over the age of eighteen years and not a party to the within entitled action; my business address is:

Suite 400
9601 Wilshire Boulevard, Beverly Hills, California 90210

On Feb. 23, 1971, I served the within Affidavits of Jack Anderson

and Leslie Whitten in Support of Motion for Reduction of Sentence and Request for Evidentiary Hearing on the Plaintiff

in said action, by placing a true copy thereof enclosed in a sealed envelope with postage thereon fully prepaid, in the United States mail at Beverly Hills, California addressed as follows:

Robert L. Meyer, United States Attorney
David R. Nissen, Assistant U.S. Attorney
Chief, Criminal Division
1200 U.S. Courthouse Building
312 North Spring Street
Los Angeles, California 90012

I certify (or declare), under penalty of perjury,* that the foregoing is true and correct.

Executed on Feb. 23 1971 at Beverly Hills California

(date)

(place)

Sybil Block

Signature

Sybil Block

*Both the verification and proof of service by mail forms, being signed under penalty of perjury, do not require notarization.

FBI

Date: 6/24/71

Transmit the following in _____
(Type in plaintext or code)

Via AIRTEL AIR MAIL
(Priority)

TO: DIRECTOR, FBI (92-3267)
FROM: SAC, LOS ANGELES (166-1048)
SUBJECT: JOHN ROSELLI, aka;
ET AL
ITAR - GAMBLING
OO: Los Angeles

JOHN ROSELLI is presently serving a five year sentence at Mc Neil Island Penitentiary as a result of his conviction in United States District Court, Los Angeles, in the Friars Club case. United States District Judge WILLIAM P. GRAY has granted a hearing to ROSELLI in his court on 7/8/71, to hear arguments on a motion for a reduction in sentence. Judge GRAY has agreed to a request by ADRIAN MARSHALL, ROSELLI's attorney, that ROSELLI be readily available for consultation with him. Judge GRAY, after first suggesting the possibility that ROSELLI could be paroled to travel to Los Angeles, has issued an order that he be brought to Los Angeles by the Bureau of Prisons. *u*

MARSHALL has previously indicated to Assistant United States Attorney DAVID R. NISSEN, United States Attorney's Office, Los Angeles, that he will call witnesses to this hearing. He also indicated the main issue will be the alleged cooperation by ROSELLI with Central Intelligence Agency (CIA) in the Cuban situation. As the Bureau is aware, JACK ANDERSON, the syndicated columnist, in January 1971, at the time ROSELLI was to surrender to begin serving his sentences in the Alien and Friars Club cases, wrote several

ICC D&D
2 - Bureau
3 - Los Angeles
(1 - 92-113)
WWH/b18
(5) *33*

REC-68
EX-105

92-3267-1044

7 JUN 28 1971

53 JUL 8 1971

Approved: _____ Sent _____ M Per _____
Special Agent in Charge

LA 166-1048

columns concerning alleged activities on the part of ROSELLI in behalf of the CIA in Cuba. Copies of these articles as well as affidavits signed by ANDERSON and LESLIE WHITTEN, an employee of ANDERSON's, have been sent to the Bureau in Los Angeles report of SA [REDACTED] dated 3/17/71, captioned as above. U

67C [REDACTED] United States District Judge PIERSON M. HALL, trial judge in the Alien case, has previously denied a hearing to ROSELLI for a reduction in sentence in that case. This motion was also based on the same alleged CIA cooperation. U

Assistant United States Attorney NISSEN has advised both MARSHALL and Judge GRAY that he will not agree to the mere filing of affidavits in a hearing for reduction of sentence. NISSEN is insisting that the person giving the affidavit appear in court so he will have the opportunity to cross examine them. MARSHALL has said he will call witnesses and NISSEN will insist on ANDERSON and his employees appearing in person if they submit affidavits. U

BENJAMIN TEITELBAUM, convicted with ROSELLI and others in the Friars Club case, surrendered to the United States Marshal, Los Angeles, this date to begin serving his sentence. TEITELBAUM originally received a four-year sentence but this was reduced on 6/21/71, to three years by Judge GRAY. MANUEL JACOBS, who was also convicted in the Friars Club case has been granted an extension until 7/9/71, to begin serving his sentence because of minor surgery which has not healed completely. U

The Bureau will be advised of pertinent developments in this matter. U

FEDERAL BUREAU OF INVESTIGATION

REPORTING OFFICE LOS ANGELES	OFFICE OF ORIGIN LOS ANGELES	DATE 7/9/75-	INVESTIGATIVE PERIOD 2/20/75 - 7/8/75
TITLE OF CASE JOHN ROSELLI, aka <i>To report 22, 33</i>		REPORT MADE BY [REDACTED] b7c	TYPED BY mtk
DECLASSIFIED BY <u><i>SP4-jm/kss</i></u> ON <u><i>3/6/81</i></u>		CHARACTER OF CASE AR	

82) CIA Info Declassed per John E. Bacon 8/27/80

~~TOP SECRET~~

REFERENCE: Report of SA [REDACTED], dated 2/25/75, at Los Angeles. Miami letter to Los Angeles, dated 6/23/75.

- P -

ADMINISTRATIVE

Set forth in the details of this report is information which has appeared in Los Angeles newspapers concerning an appearance by JOHN ROSELLI before a Special Senate Committee headed by Senator FRANK CHURCH on 6/24/75. This testimony allegedly reveals efforts by

*Classified by 4640
Exempt from GDS Category 2
Date of Declassification Indefinite
11/29/77
[Signature]*

ACCOMPLISHMENTS CLAIMED					<input checked="" type="checkbox"/> NONE	ACQUIT-TALS	CASE HAS BEEN:
CONVIC.	FUG.	FINES	SAVINGS	RECOVERIES			PENDING OVER ONE YEAR <input type="checkbox"/> YES <input type="checkbox"/> NO PENDING PROSECUTION OVER SIX MONTHS <input type="checkbox"/> YES <input checked="" type="checkbox"/> NO

APPROVED *[Signature]* SPECIAL AGENT IN CHARGE

COPIES MADE:

- 3 - Bureau (92-3267)
- 2 - USA, Los Angeles (1 - Special Prosecutions Unit) (1 - RICHARD P. CRANE, AIC, Los Angeles Strike Force)
- 2 - Miami (92-517)
- 2 - Los Angeles (92-113)

DO NOT WRITE IN SPACES BELOW

92-3267-1051 REC 68

JUL 14 1975

Dissemination Record of Attached Report

Agency	<i>2 cc, SAC, Criminal Division, Organized Crime & Racketeering Section,</i>
Request Recd.	
Date Fwd.	<i>7/17/75</i>
How Fwd.	
By	<i>7/11/75</i>

Notations

~~TOP SECRET~~

~~DATA PROC. UNIT~~

~~PERS. REC. UNIT~~

LA 92-113

JOHN ROSELLI to assassinate FIDEL CASTRO on behalf of the Central Intelligence Agency (CIA). U

The connection between ROSELLI and the CIA first came to the attention of the Los Angeles Office in an investigation entitled, "ARTHUR JAMES BALLETTI; ET AL; UPUC, Los Angeles file 139-77, Bureau file 139-1201." BALLETTI had installed illegal microphones in the Suite of DAN ROWAN, one of the partners in the Rowan & Martin Comedy Team at the Riviera Hotel, Las Vegas. ROWAN, at the time, was dating PHYLLIS MC GUIRE, who had been up until that time the girl friend of SAM GIANCANA, the "Boss" of the Chicago Family of the La Cosa Nostra (LCN). U

During the course of the investigation of the above matter, interviews were conducted with ROBERT MAHEU, a former Special Agent of the FBI, who advised that he had been contacted during the latter part of 1960 by Colonel SHEFFIELD EDWARDS, Director of Security, CIA. According to MAHEU, EDWARDS requested him to contact SAM GIANCANA since gambling activities in Cuba had been controlled by GIANCANA and his associates in Cuba and the CIA believed that GIANCANA would still have sources and contacts in Cuba which could possibly be used by the CIA. MAHEU subsequently admitted that he had met with ROSELLI at the Kenilworth Hotel in Miami Beach, Florida, in October of 1960 regarding this matter. ROSELLI was using the name of J. A. ROLLINS at that time. (S)

MAHEU advised that the reason the microphone had been put in DAN ROWAN's room was because he had received information that there had been leaks concerning his relationship with the CIA and he thought that these leaks might possibly be through SAM GIANCANA to PHYLLIS MC GUIRE to DAN ROWAN.

During the BALLETTI investigation, Colonel EDWARDS of the CIA was contacted and admitted that he had contacted MAHEU as a go-between in contacts with GIANCANA. EDWARDS admitted the reason for contacts with GIANCANA were because

- B -
COVER PAGE

TOP SECRET

LA 92-113

GIANCANA and his associates had formerly controlled gambling prior to CASTRO coming to power and the CIA was hopeful of using their sources and contacts. Colonel EDWARDS advised that the CIA had hoped to use these sources and contacts in connection with the CIA's clandestine efforts against the CASTRO Government. He did not explain this further.

b2
b7D

The Chicago Office advised on 12/11/61, that according to ██████████ ROSELLI and GIANCANA discussed electronic monitoring equipment during which time the CIA was mentioned.

On 6/20/63, JOHN ROSELLI was observed to depart Los Angeles for Washington, D.C. on TWA flight 60, under the name of J. RALSTON. Special Agents of the Richmond Division observed ROSELLI depart from this flight, at which time he was met by an individual driving an automobile registered to WILLIAM KING HARVEY of Montgomery County, Maryland. ROSELLI and the individual, subsequently identified as HARVEY, proceeded to Washington, D. C. HARVEY is a former Bureau Agent and in 1963 held a high position with the CIA. U

Subsequently, the CIA advised the Bureau that ROSELLI had been in contact with a representative of the CIA and that according to the CIA, ROSELLI had periodically indicated that he was in a position to be of assistance regarding Cuban Matters. The CIA informed the Bureau that this last meeting between ROSELLI and a representative of the CIA was to close out this entire matter. ROSELLI, according to the CIA, had not been given any financial remuneration and the CIA had never made any commitments to ROSELLI.

During May of 1966, efforts were made by the Los Angeles Office to develop ROSELLI as a C-TE. Within several days of the contact by FBI Agents, ROSELLI traveled to Washington, D. C., and contacted Colonel EDWARDS about his meeting with FBI Agents. ROSELLI told EDWARDS that he had been approached by two FBI Agents who told him that they

- C -
COVER PAGE

~~SECRET~~

LA 92-113

wanted to talk to him alone and that it pertained to National Security. He told Colonel EDWARDS that the Agent attempted to give him an envelope which he refused to take. When ROSELLI returned home, he found this same envelope at his apartment reception desk and that it contained a picture of a woman and child. ROSELLI told him the picture of the child was himself at that age. According to Colonel EDWARDS, ROSELLI made no requests of him to make any inquiry or to do anything concerning this and he was merely informing Colonel EDWARDS of this information. ~~S~~ (u)

Prior to a trial in U. S. District Court (USDC), Los Angeles, in early 1968, of ROSELLI on Alien Charges, efforts were made by the Bureau to secure the assistance of Colonel EDWARDS as a witness to the admissions made to him by ROSELLI. The CIA declined to allow Colonel EDWARDS to testify because it would immediately "open the door" to public exposure of an extremely sensitive intelligence operation. ~~S~~ (u)

In April of 1968, information was received from the U. S. Attorney's Office, Los Angeles, that the Department of Justice had received a request from the CIA and the indictment of ROSELLI be quashed because he was a CIA informant. The indictment was not quashed and ROSELLI was subsequently convicted and sentenced to six months in custody of the Attorney General on these charges.

On 3/1/71, ADRIAN MARSHALL and TOM WADDEN, Attorneys for JOHN ROSELLI, appeared in USDC, Los Angeles, in an effort to obtain a hearing date for a modification of sentence for ROSELLI based on a series of articles written by syndicated columnist JACK ANDERSON. These articles alleged that JOHN ROSELLI was involved with the CIA in clandestine operations involving Cuba. The U. S. District Judge denied the hearings and commented that even if the articles were true, it would not have an effect on the sentence he imposed on ROSELLI. The affidavits of ANDERSON are set out in the Los Angeles report of SA [REDACTED], dated 3/17/71, in this matter. ^{b7c} u

LA 92-113

ROSELLI's attorney, ADRIAN MARSHALL, appeared in another USDC, Los Angeles, in the Friars Club Case on 7/7/71, and attempted to argue for a reduction in sentence based on ROSELLI's alleged participation with the CIA in a plot to assassinate CASTRO. The U. S. District Judge interrupted MARSHALL prior to his finishing his argument and told MARSHALL that ROSELLI's cooperation with the CIA would not give ROSELLI any "brownie points" in his court room and that such an event would have been catastrophic in his opinion. U

The above is a summary of the information contained in Los Angeles files regarding ROSELLI's association with the CIA and is being set out in this report in view of the information set out in the details of this report that ROSELLI had testified before a Senate Committee investigating the CIA. U

LEADS

MIAMI

AT MIAMI, FLORIDA: Will continue to follow and report the results of ROSELLI's appeal to the Board of Immigration Appeals, Washington, D. C. U

LOS ANGELES

AT LOS ANGELES, CALIFORNIA: Will continue to follow and report the activities of ROSELLI. U

- E* -
COVER PAGE

~~TOP SECRET~~

UNITED STATES DEPARTMENT OF JUSTICE
FEDERAL BUREAU OF INVESTIGATION

Copy to: 2 - USA, Los Angeles
(1 - Special Prosecutions Unit)
(1 - RICHARD P. CRANE, AIC,
Los Angeles Strike Force)

Report of: *b7c* [REDACTED] Office: Los Angeles, California
Date: 7/9/75

Field Office File #: 92-113 Bureau File #: 92-3267

Title: JOHN ROSELLI

Character: ANTI - RACKETEERING

Synopsis: ROSELLI's appeal to the order deporting him to Italy on 1/10/75, is still under appeal in Washington, D. C. ROSELLI appeared before the CHURCH Senate Committee investigating CIA and allegedly testified to his involvement with CIA. SAM GIANCANA, close associate of ROSELLI, murdered in Chicago, Illinois, 6/19/75. *u*

- P -

DETAILS:

The Miami Office advised as follows on June 23, 1975: *u*

b7c [REDACTED] Secretary, Office of the Trial Attorney, Immigration and Naturalization Service (INS), Federal Building, Miami, Florida, advised on June 23, 1975, that subject's immigration case is still under appeal in Washington, D. C. *u*

FOIPA # 22, 330
ALL INFORMATION CONTAINED
HEREIN IS UNCLASSIFIED
DATE *3/6/81* BY *SP4-gjm/ka*

LA 92-113

Mr. DAVID W. WALTERS, Attorney, Suite 1001, 100 Biscayne Boulevard, Miami, Florida, stated on June 23, 1975, that he was representing the subject in his immigration case, which is now under appeal. He said he also represents ROSELLI in litigation with the U. S. Army over ROSELLI's discharge from the Army in World War II. ROSELLI is contending that he is entitled to an honorable type discharge. U

Mr. WALTERS said that he has no information relating to ROSELLI's connection with alleged attempts on the life of FIDEL CASTRO. He said ROSELLI never alluded to the allegation, although he, WALTERS, has been contacted by the press concerning ROSELLI's alleged part in the conspiracy. He said it was rumored by the press that ROSELLI would testify before a U. S. Senate Committee in the near future. U

The 'Los Angeles Times,' the Los Angeles 'Herald Examiner', the 'New York Post', and the 'New York Times', all carried articles in their June 25, 1975, editions regarding JOHN ROSELLI and his testimony before the Senate Select Committee on Intelligence which is chaired by Senator FRANK CHURCH. The article published by the 'New York Times' is as follows: U

"WASHINGTON, June 24, John Roselli, a former member of the Al Capone gang and an operative of the Mafia for most of his adult life, told a Senate committee today that he had been recruited by the Central Intelligence Agency in a plot to kill Premier Fidel Castro of Cuba, according to members of the committee." U

"Mr. Roselli, a tanned, stocky 69-year-old man, testified before the Senate Select Committee on Intelligence under heavy guard in a closed session for some two hours. According to the committee chairman, Senator Frank Church, Democrat of Idaho, Mr. Roselli's testimony 'filled in, in much greater detail, (the plot) and did not depart from what has been published in the press.' " U

"Earlier Mr. Church had said that the committee had evidence that the C.I.A. was involved in assassination plots and assassination attempts. Senator John G. Tower, Republican of Texas, who is the committee vice chairman, said that Mr. Roselli had provided 'details of contacts that were made,' adding, 'It doesn't throw any new light on the situation as I see it.' He said that as a result of Mr. Roselli's testimony and other evidence, the premise that the C.I.A. used the Mafia to try to kill Premier Castro 'is pretty well laid on the record.' "

"According to published reports, Mr. Roselli was recruited in late 1960 by Robert A. Maheu, acting on behalf of the C.I.A., in a plot to kill Mr. Castro. Mr. Maheu, according to authoritative sources, also recruited Sam Giancana, a Chicago rackets boss, in what was essentially a plan to poison the three top leaders of the Cuban Government and create a power vacuum in the new revolutionary state."

"Mr. Giancana was shot to death last Thursday in his Oak Park, Ill., home. His killers have not been apprehended. The Chicago police have described the killing as a premeditated 'execution.' Senator Church said that the committee had planned to call Mr. Giancana as a witness."

"Mr. Giancana's death left Mr. Roselli as the only organized crime figure who is known to have been connected with the plot. Leslie Scherr, one of the two lawyers who accompanied Mr. Roselli to the hearing, said later that Mr. Giancana's death had not caused Mr. Roselli to fear for himself, but for members of his family."

"Another source said that Mr. Roselli was concerned about possible retaliation from Cuban nationalist groups rather than fearing an attack from organized crime elements."

"Whatever his fears, Mr. Roselli came before the committee under extraordinary security precautions. He was taken to and from the committee room by back stairs and elevators under the guard of the Capitol police. Photographers took pictures of several men who appeared to be Mr. Roselli." u

"Photographs of Mr. Roselli have not been published for several years and many of the newsmen did not know what he looked like. According to Mr. Scherr, a practice attempt was made to mislead newsmen as to who Mr. Roselli was. Mr. Scherr said he did not believe any news agency had been successful in photographing Mr. Roselli and that he would 'urge any organization not to use the picture if they had it.'" u

"Senator Church said that the committee had agreed to help Mr. Roselli in avoiding the press. He said that the committee had permitted Mr. Roselli to name only C.I.A. officials with whom he dealt and not to name private parties. Mr. Roselli was concerned about the safety of private parties if their names became known, Mr. Church said." u

"Mr. Roselli was dressed in a well-tailored black suit, tailored shirt with cufflinks and conservative tie. He answered the committee's questions calmly, one member said, and appeared to be like 'anybody's grandfather.'" u

"CAREER BEGAN IN 1930'S"

"Mr. Roselli gave his testimony in 'layman's terms' and used little gangland slang, the member said. Mr. Roselli was reportedly serious but occasionally displayed a wry sense of humor. When one committee member asked him how he could quickly identify a particular agent of the Federal Bureau of Investigation the witness rejoined, 'because he followed me for three years. He was in charge of my case.'" u

LA 92-113

"Mr. Roselli's criminal career began in the nineteen-thirties when he was arrested 16 times on charges of carrying a gun while in the gang controlled by Al Capone. He served in the Army from 1942 to 1945, and received an undesirable discharge." u

"It was while in the service that Mr. Roselli was convicted of a scheme to extort money from Hollywood figures that stemmed from activities before the war. He was not convicted again until 1969 when he was sentenced to five years in Prison for a card cheating scandal at the Friars Club in Los Angeles." u

"The Government, at that time, began efforts to deport Mr. Roselli to Italy, where he was born in 1905. The case is being appealed. Mr. Roselli is; also suing to have his discharge changed from undesirable to honorable." u

"In the next two days the committee is expected to hear testimony from Mr. Maheu and C.I.A. officials familiar with the plot." u

The article by the 'Herald Examiner' contains a photograph of several individuals leaving the Senate after testifying before the Committee. Included in this photograph is a picture of JOHN ROSELLI and one of his attorneys, JAMES P. CANTILLON. It is noted that CANTILLON's name does not appear in any of the articles as the attorney representing ROSELLI before the Committee. u

According to the local Los Angeles newspapers, SAM GIANCANA was shot and killed in his residence in the Chicago area on June 19, 1975. u

airtel

B
7/22/75

To: SAC, Los Angeles (92-113)

1 - Legal Counsel

REC-26
From: Director, FBI (92-3267) *1052*

JOHN ROSELLI, aka *EX-117*
AR
OO: Los Angeles

Re Los Angeles letter to the Bureau 7/9/75. *u*

Roselli's testimony before the Senate Committee was given in Executive Session and the Bureau is not privy to testimony of individuals furnished in Executive Session. *u*

If, at a future date, the testimony is made available to the Bureau, you will be furnished a copy at such time. *u*

NOTE: Los Angeles has requested a copy of John Roselli's testimony before the Special Investigative Committee, chaired by Senator Frank Church concerning his appearance on 6/24/75 in which he testified relating to his relationship with the CIA. Los Angeles feels that if a copy of his testimony is available and furnished to them, it could be reviewed by an Agent of the Los Angeles Office in an effort to develop a perjury charge against Roselli.

b7c SA [redacted], Legal Counsel Division, was telephonically contacted by SA [redacted] on 7/21/75 and [redacted] advised that the Bureau does not have access to testimony given by Roselli and others because it was given in Executive Session before the Committee.

MAILED 5
JUL 22 1975
FBI

RFH:bam *bam*
(5)

- Assoc. Dir. _____
- Dep. AD Adm. _____
- Dep. AD Inv. _____
- Asst. Dir.:
- Admin. _____
- Comp. Syst. _____
- Ext. Affairs _____
- Files & Com. _____
- Gen. Inv. _____
- Ident. _____
- Inspection _____
- Intell. _____
- Laboratory _____
- Plan. & Eval. _____
- Spec. Inv. _____
- Training _____
- Legal Coun. _____
- Telephone Rm. _____
- Director Sec'y _____

102
156
JUL 29 1975

MAIL ROOM TELETYPE UNIT

UNITED STATES GOVERNMENT

Memorandum

TO : DIRECTOR, FBI

(92-3267)

DATE: 7/9/75

FROM : SAC, LOS ANGELES

(92-113) (P)
ALL INFORMATION CONTAINED
HEREIN IS UNCLASSIFIED
DATE 3/9/81 BY SP4-jm/ada

SUBJECT: JOHN ROSELLI, aka
AR

(OO: Los Angeles) *CIA info unclassified per John E. Bacon 8/22/81

As the Bureau is aware, JOHN ROSELLI has been under intensive investigation by the Bureau under the Bureau's former Top Hoodlum Program and the present Criminal Intelligence Program since 1957. In the early 1960's, ROSELLI was named by the Bureau as a subject for intensified investigation.

In 1968, ROSELLI was convicted in two separate cases initiated and investigated by the Los Angeles Office. He has served time as a result of these two convictions. Since ROSELLI's release from prison in October of 1973, he has moved to Florida but continues to spend some time in Los Angeles. In Florida ROSELLI has been ordered deported by an INS Hearing Officer and he is currently appealing this decision.

During the intensified investigation conducted by the Bureau on ROSELLI's activities, it was learned as early as 1960, that ROSELLI had an association with the Central Intelligence Agency (CIA) through ROBERT MAHEU, a former FBI Agent. Several other instances of contacts between ROSELLI and the CIA were developed over the years, including a surveillance in 1963 when ROSELLI was picked up at Dulles Airport by a CIA agent, WILLIAM HARVEY. ROSELLI's attorney also attempted to use his alleged association with the CIA in efforts to have his sentences reduced in his conviction for being an illegal alien and for his conviction in the Friars Club Case; however, the judges in both instances refused to reduce the sentences.

2 - Bureau (RM)
2 - Los Angeles

WWH/mtk
(4)

REC-39 92-3267-1052

ST-117

JUL 14 1975

airtel to LA
7-22-75
RHH:ban
KANE



LA 92-113

Following ROSELLI's convictions in the Alien and Friars Club Cases, he was granted immunity during the investigation into hidden interests by the Detroit La Cosa Nostra (LCN) in the Frontier Hotel, Las Vegas, Nevada, which eventually led to the convictions of ANTHONY ZERILLI, MICHAEL POLIZZI, and ANTHONY GIARDANO on ITAR - GAMBLING Charges. ROSELLI answered all questions put to him before the Federal Grand Jury by former Assistant U. S. Attorney DAVID R. NISSEN; however, he was found to be a very intelligent witness who was able to perjure himself in those areas he knew the Government would be unable to prove without divulging informants. u

Newspaper articles in Los Angeles have revealed that ROSELLI has testified concerning his relationship with the CIA before the Special Senate Committee chaired by Senator FRANK CHURCH on 6/24/75. These articles revealed that ROSELLI allegedly furnished an interview with JACK ANDERSON concerning his testimony immediately following his testimony. u

The Los Angeles Office feels that in view of the vast amount of information developed during the intensified investigation of ROSELLI, that ROSELLI's testimony should be reviewed by an Agent of the Los Angeles Office in an effort to develop a perjury case on him. u

The Bureau, if not already done, is requested to obtain a copy of ROSELLI's testimony before this Senate Committee and furnish same to the Los Angeles Office. u

FEDERAL BUREAU OF INVESTIGATION

REPORTING OFFICE LOS ANGELES	OFFICE OF ORIGIN LOS ANGELES	DATE 10/8/75	INVESTIGATIVE PERIOD 7/9/75 - 10/7/75
TITLE OF CASE JOHN ROSELLI, aka		REPORT MADE BY [REDACTED] b7C	TYPED BY ntk
		CHARACTER OF CASE AR	

REFERENCES: Los Angeles report of SA [REDACTED] **b7C**
 [REDACTED] dated 7/9/75.
 Los Angeles letter to the Bureau,
 dated 7/9/75.
 Bureau letter to Los Angeles,
 dated 7/22/75.

TH
D

- P* -

ADMINISTRATIVE

This matter is being placed in a pending inactive status for a period of six months, at which time it will be reactivated to report any changes in the appeal by ROSELLI.

ACCOMPLISHMENTS CLAIMED				<input checked="" type="checkbox"/> NONE	ACQUIT-TALS	CASE HAS BEEN:
CONVIC.	FUG.	FINES	SAVINGS	RECOVERIES		
						PENDING OVER ONE YEAR <input checked="" type="checkbox"/> YES <input type="checkbox"/> NO PENDING PROSECUTION OVER SIX MONTHS <input type="checkbox"/> YES <input checked="" type="checkbox"/> NO

APPROVED <i>[Signature]</i> SPECIAL AGENT IN CHARGE	DO NOT WRITE IN SPACES BELOW
COPIES MADE: 3 - Bureau (92-3267) 2 - USA, Los Angeles (1 - Special Prosecutions Unit) (1 - RICHARD P. CRANE, AIC, Los Angeles Strike Force) 2 - Miami (92-517) 2 - Los Angeles (92-113)	92-3267-1384 OCT 14 1975 REC-21 EY 103

Dissemination Record of Attached Report				Notations DATA PROC
Agency				
Request Recd.		CC, AAG, Criminal		
Date Fwd.		Division, Organized Crima		
How Fwd.		& Racketeering Section,		
By	700012			

LA 92-113

to the INS Deportation Order in Miami, Florida. u

By letter, dated 7/9/75, the Bureau was requested to attempt to obtain copies of ROSELLI's testimony before the Special Senate Committee chaired by Senator FRANK CHURCH. The Bureau advised on 7/22/75, that ROSELLI's testimony before this Committee was given an Executive Session and this Bureau is not privy to testimony of individuals furnished in Executive Sessions. u

LEADS

MIAMI

AT MIAMI, FLORIDA: Will report any changes in ROSELLI's INS appeal to the Board of Immigration Appeals, Washington, D. C. u

LOS ANGELES

AT LOS ANGELES, CALIFORNIA: Will reactivate this matter after six months. u

UNITED STATES DEPARTMENT OF JUSTICE
FEDERAL BUREAU OF INVESTIGATION

2 - USA, Los Angeles
(1 - Special Prosecutions Unit)
(1 - RICHARD P. CRANE, AIC,
Los Angeles Strike Force)

Copy to:

Report of:

Date:

[REDACTED] b7C
10/8/75

Office: Los Angeles, California

Field Office File #:

92-113

Bureau File #: 92-3267

Title:

JOHN ROSELLI

Character:

ANTI - RACKETEERING

Synopsis:

ROBERT MAHEW and RICHARD M. BISSELL testified before the Special Senate Committee chaired by Senator FRANK CHURCH as to their part in arranging for ROSELLI who worked for the CIA. Interview with JAMES CANTILLON, Former Attorney for ROSELLI, set forth. u

- P* -

DETAILS:

It had been previously reported that JOHN ROSELLI on June 24, 1975, according to the "Los Angeles Times" and the "New York Times" appeared before the Senate Select Committee on Intelligence, which is chaired by Senator FRANK CHURCH and testified that he had been contacted by the Central Intelligence Agency (CIA) through ROBERT MAHEW, to try to kill Premier CASTRO of Cuba. u

LA 92-113

According to the "Los Angeles Times" of July 30, 1975, RICHARD M. BISSELL, a former Chief of Clandestine Services for the CIA, testified before the CHURCH Committee that he personally had approved the CIA cooperation with "Mafia" figures to assassinate Cuban Premier CASTRO in 1960. BISSELL when questioned by reporters said arrangements with the Mafia had been handled by the office of the late Colonel SHEFFIELD EDWARDS, through ROBERT A. MAHEW. Colonel SHEFFIELD EDWARDS was the CIA's Director of Security. BISSELL told reporters that Colonel EDWARDS had arranged the highly secret cooperation with Underworld figures SAM GIANCANA and JOHN ROSELLI, but that he, BISSELL, had approved it. U

BISSELL said that the arrangements with the Mafia began "in the last half of 1960" and might have been suggested to the CIA by GIANCANA or other Mafia figures because "they did have very large interests in Cuba that were totally eclipsed or destroyed by Castro." BISSELL also speculated that Underworld figures were seeking to build up credit with the U. S. Government against possible Federal prosecution in the future. U

According to the "Los Angeles Times" and the "Los Angeles Herald Examiner" on July 31, 1975, ROBERT A. MAHEW testified before the CHURCH Committee on July 30, 1975. Following his two days of testimony behind closed doors he told reporters that he once helped the CIA develop plans to poison CASTRO because, "I felt we were involved in a just war." MAHEW told reporters that he had recruited ROSELLI and GIANCANA in 1960 at the suggestion of two CIA officials. The CIA had paid him \$500.00 a month for private investigator work during the late 1950's. MAHEW said he was also approached on the CASTRO Matter in 1960 by JAMES J. O'CONNELL, a CIA Supervisor, who had previously served as his contact. MAHEW told reporters that O'CONNELL asked him to contact JOHN ROSELLI in Los Angeles and asked ROSELLI if he would assist the CIA in a program for removing CASTRO. MAHEW told reporters that ROSELLI was reluctant to participate but later agreed to help, "When I explained this would be on behalf of his Government, unpleasant as it may sound."

LA 92-113

MAHEW told reporters that the value of ROSELLI and GIANCANA was their contacts and sources of information in Havana where they previously had interests in lucrative gambling casinos closed down by CASTRO. MAHEW said the assassination plan he knew about was a scheme to poison CASTRO that O'CONNELL discussed at a series of meetings at Miami's Fontainebleau Hotel in early 1961. ROSELLI was to deliver poison capsules to one of CASTRO's cooks or domestics, "who would be in a position to administer them if the CIA gave us the 'go' signal." MAHEW said that O'CONNELL showed him the capsules in a white envelope and stated that as far as he knew the CIA never gave the "go" signal. MAHEW said that after the CIA sponsored the Bay of Pigs Invasion in April of 1961, that he phased out his cooperation with the CIA. U

JAMES CANTILLON, Los Angeles Attorney, who has represented JOHN ROSELLI in the past, was met casually on September 10, 1975, at a local Los Angeles restaurant. CANTILLON advised that ROSELLI was currently residing in the Miami area near his sister, EDITH DAGEL. He advised that ROSELLI is traveling between Miami and Washington, D.C., frequently as ROSELLI's attorney in Miami has determined that if ROSELLI can have his Army discharge changed from other than honorable to honorable, he will be a citizen automatically and his problem of being deported will be over. ROSELLI has taken steps to try to convince the Army that his discharge should be changed. U

CANTILLON also commented that he had been in Washington, D. C., awaiting a call to testify before the CHURCH Committee when SAM GIANCANA was found shot to death in his Chicago residence. CANTILLON said as soon as he had received word of GIANCANA's death, he had called ROSELLI in the Miami area to be certain that ROSELLI knew of GIANCANA's death and also to be certain that ROSELLI was still alive. CANTILLON said that he actually talked to ROSELLI on this occasion. CANTILLON further stated that he had subsequently testified before the CHURCH Committee. He declined to comment as to what his testimony had been and remarked facetiously that he had testified about the agent. U

LA 92-113

It should be noted that ROSELLI was inducted into the U. S. Army on December 4, 1942 at Fort Mc Arthur, California, and had Army Serial Number 39547191. On December 23, 1942, he was transferred to the Fifth Armored Division, Camp Hook, California, and on May 25, 1943, he was transferred to Governor's Island, New York City. He remained at Governor's Island until he was confined by civil authorities on December 30, 1943. ROSELLI received a discharge, other than honorable on June 30, 1945, at Fort Mc Pherson, Georgia, under Provisions of Section 3AR615-366, because of his conviction of a crime by a Civil Court. u

FEDERAL BUREAU OF INVESTIGATION

REPORTING OFFICE LOS ANGELES	OFFICE OF ORIGIN LOS ANGELES	DATE 5/14/76	INVESTIGATIVE PERIOD 10/7/75 - 5/12/76
TITLE OF CASE JOHN ROSELLI, aka		REPORT MADE BY [REDACTED] b7C	TYPED BY mtk
		CHARACTER OF CASE AR	

REFERENCES: Report of SA **[REDACTED]**, dated 10/8/75, at Los Angeles. Miami letters to Los Angeles, dated 11/19/75, and 4/6/76.

- P* -

ADMINISTRATIVE

This matter has been in a pending inactive status since the date of referenced report. It has been made pending to report results of ROSELLI's appeal to an Immigration and Naturalization Service (INS) order that he be deported. This report is also to report the current activities of ROSELLI.

ACCOMPLISHMENTS CLAIMED				<input checked="" type="checkbox"/> NONE		ACQUIT-TALS	CASE HAS BEEN:
CONVIC.	PRETRIAL DIVERSION	FINES	SAVINGS	RECOVERIES			

APPROVED <i>[Signature]</i>	SPECIAL AGENT IN CHARGE	DO NOT WRITE IN SPACES BELOW	
COPIES MADE 3 - Bureau (92-3267) 1 - U. S. Strike Force, Los Angeles (ATTN: MICHAEL DE FEO, AIC, LA) 2 - Miami (92-517) 2 - Los Angeles (92-113)		92-2247-1055 4 MAY 17 1976	

Dissemination Record of Attached Report				Notations DATA PROC.
Agency				
Request Recd.	Division of Organized Crime & Racketeering Section			
Date Fwd.	Room 2744			
How Fwd.				

66 MAY 28 1976
F31

LA 92-113

This matter is again being placed in a pending inactive status for a period of six (6) months at which time it will again be reactivated to report any change in ROSELLI's INS deportation order. ~

INFORMANTS

b2

b7D



LEADS

MIAMI

AT MIAMI, FLORIDA: Will report any changes in ROSELLI's INS deportation order. ~

LOS ANGELES

AT LOS ANGELES, CALIFORNIA: Will reactivate this matter after six months. ~

UNITED STATES DEPARTMENT OF JUSTICE
FEDERAL BUREAU OF INVESTIGATION

Copy to: 1 - U. S. Strike Force, Los Angeles
(ATTN: MICHAEL DE FEO, AIC)

Report of: **b7c** [REDACTED] Office: Los Angeles, California
Date: 5/14/76

Field Office File #: 92-113 Bureau File #: 92-3267

Title: JOHN ROSELLI

Character: ANTI-RACKETEERING

Synopsis: ROSELLI's appeal to order of deportation imposed on him by INS, has been denied by the Immigration Court, Washington, D. C. INS is having difficulty finding a country who will accept ROSELLI. ROSELLI's attorney expects a modification of deportation order. ROSELLI visited Los Angeles area for approximately three (3) weeks during latter part of January and early February of 1976. Newspaper article regarding JUDITH CAMPBELL (now JUDITH EXNER) printed in 'New York Times' set forth. Ⓞ

- P* -

DETAILS:

The Miami Office advised as follows on April 6, 1976:

b7c On November 13, 1975, [REDACTED] Clerk, Immigration Court, Immigration and Naturalization Service (INS),

Sources whose identities are concealed herein have furnished reliable information in the past except where otherwise noted.

LA 92-113

Miami, Florida, advised that JOHN ROSELLI's appeal for the order of deportation imposed on him had been denied by the Immigration Court in Washington, D. C., and the order of deportation was returned to INS, Miami, Florida, on October 10, 1975, for execution.

b1c [redacted] advised that ROSELLI's case presently is under the jurisdiction of the Deportation Section, INS, Miami.

Mr. DAVID WALTERS, Attorney, Suite 1001, 100 Biscayne Boulevard, Miami, Florida advised on November 13, 1975, that his client, JOHN ROSELLI, was presently under a deportation process by the INS at Miami. Mr. WALTERS said deportation of ROSELLI will not take place in the foreseeable future, since problems are being encountered in finding a country that would accept ROSELLI. He said also ROSELLI is over 70 years of age. His age could be a factor in modifying the deportation order. ROSELLI's case, according to Mr. WALTERS, as far as deporation is concerned, is presently under discussion with officials of the Deportation Section. No decision is expected in this matter in the immediate future.

On [redacted] advised that JOHN ROSELLI was planning on visiting the Los Angeles Office during January of 1976.

b2
b7D
OS
[redacted] ROSELLI was in Los Angeles staying at the Beverly Hilton Hotel. ROSELLI was allegedly in Los Angeles regarding his immigration problems. The informant advised that ROSELLI had been in contact with [redacted], and JAMES CANTILLON. [redacted] is a business partner of ROSELLI's in the gift shop at the Frontier Hotel, Las Vegas, Nevada. [redacted], true name [redacted] is a well known hoodlum in the Los Angeles area. JAMES CANTILLON is an attorney and a long time friend of ROSELLI's. W.D.S.A.

[redacted]
ROSELLI had returned to Miami. The informant advised that

LA 92-113

b7C while in Los Angeles, ROSELLI spent [REDACTED]

b7D
QS said that [REDACTED] lives on [REDACTED] California. u

'The New York Times', Late City Edition of April 12, 1976, contained the following article regarding JUDITH CAMPBELL (now Mrs. JUDITH EXNER) and her association with ROSELLI, SAM GIANCANA, FRANK SINATRA, and the late President JOHN F. KENNEDY: u

(Mount Clipping in Space Below)

Link of Kennedy Friend To Mafia Is Still a Puzzle

By NICHOLAS GAGE

The disclosure last December that President Kennedy and two major Mafia figures maintained close friendships with the same woman — Judith Campbell — has puzzled many private citizens, disturbed some law enforcement officials and aroused extensive speculation in and out of Government.

The speculation has been stimulated because the two intelligence agencies, which investigated the C.I.A. plots, referred only briefly to Mrs. Campbell's relationships, devoting slightly more than a page to them in its 348-page report last December. The report did not identify Mrs. Campbell (now Mrs. Judith Exner) by name or sex, and left a number of questions unanswered.

Among them were whether Mrs. Campbell used her relationship with Mr. Kennedy to benefit the Mafia, and whether the President learned as a result of the Campbell friendship that the C.I.A. was working with the Mafia on a plot to kill Mr. Castro.

Interviews and Findings

During the last two months, The New York Times, in interviews with current and former Justice Department officials, participants in the C.I.A. plots and underworld figures, has examined these questions and found the following:

(Indicate page, name of newspaper, city and state.)

P.2 NEW YORK TIMES
NEW YORK, NY

Date: 4/12/76
Edition: Late City Edit
Author: Nicholas Gage
Editor:
Title:

Character:
or
Classification:

Several recommendations were made within the Justice Department in 1962 for a thorough investigation of Mrs. Campbell's Mafia ties, but no inquiry was ever conducted. When high Justice officials learned about her friendship with President Kennedy in early 1962, they looked upon it as a "domestic matter," as one of them put it, and merely passed information on her to the White House.

Sam Giancana—who was slain last June — and John Roselli boasted to fellow gangsters about sharing the affections of a woman who was seeing the President, but they do not appear to have benefited further from their knowledge of Mrs. Campbell's friendship with Mr. Kennedy.

While the Senate committee found no evidence that President Kennedy knew about the C.I.A.-Mafia plots to kill Mr. Castro, the possibility appears high to some former Justice officials that Robert F. Kennedy, then the Attorney General, told his brother about the plots in view of what he learned about the relationships of Mr. Giancana, Mr. Roselli and Mrs. Campbell in 1962 and early 1963.

When the Senate committee investigated Mrs. Campbell's friendships, not only did the committee not call Frank Sinatra, who introduced Mrs. Campbell both to President Kennedy and to Mr. Giancana, but other key individuals were merely interviewed rather than questioned under oath, even though a deeper inquiry might have produced information affecting the committee's conclusion that President Kennedy did not know about the C.I.A.-Mafia plots against Mr. Castro.

Staying Out of Sight

A spokesman for the committee, Spencer Davis, said that the panel's mandate was to determine whether Mrs. Campbell was involved in an intelligence operation and not to conduct a broad investigation of her Mafia ties.

The couple was divorced in 1958, and a year later she began to date Mr. Sinatra, she said in the outline for a book she plans to write. Mrs. Campbell said that she ended her affair with the singer because their tastes in sex differed, but continued to travel with the Sinatra crowd.

"The difference with Judy was that she was pushy and reckless," the friend said. "She'd go to Johnny's place and call everyone she knew from his phone, or she'd call Sam at his home and at the Armory Lounge in Chicago, where he hung out. So the Feds picked up her tracks."

Sinatra's Reply

In reply to this assertion, Mr. Sinatra issued this statement: "Hell hath no fury like a hustler with a literary agent."

Mrs. Campbell said in the outline that Mr. Sinatra introduced her to John F. Kennedy on Feb. 7, 1960, in Las Vegas, Nev., and they made plans to meet in early March in New York, where they began to have an affair.

After her New York meeting with Mr. Kennedy, according to the outline, she accepted an invitation to meet Mr. Sinatra in Miami Beach, where he was performing at the Fontainebleau Hotel, and the entertainer introduced her there to Mr. Giancana.

Five months later Mr. Giancana and Mr. Roselli became involved with the C.I.A. in plots to kill Fidel Castro—recruiting Cuban agents who might be persuaded to poison Mr. Castro's food—but apparently they did not tell Mrs. Campbell about them. Mafia members traditionally do not confide in their women and Mr. Giancana and Mr. Roselli made no exception with Mrs. Campbell, according to the close friend of both men.

His contention is supported by participants in the plots, including Robert Maheu, who has acknowledged bringing together the Mafia and the C.I.A. Mrs. Campbell said in her book outline that she had "no knowledge of C.I.A. involvement with the Mafia."

The close friend of Mr. Giancana and Mr. Roselli said that, at that time, Mrs. Campbell was one of about 20 women, some of them well-known actresses, who were in the Sinatra crowd and were introduced to the entertainer's friends in public life and in the underworld.

The Federal Bureau of Investigation first picked up Judith Campbell through electronic surveillance of Mr. Roselli in early 1961, according to Justice Department sources.

The F.B.I. checked out her long-distance calls over the next two years and found that she was in frequent contact with Mr. Roselli, Mr. Giancana and Mr. Sinatra.

For example, Government records show that during one four-week period, from June 8 to July 3, 1962, Mrs. Campbell called Mr. Giancana 23 times at his Chicago home and 37 times at the Armory Lounge from her Los Angeles residence at 8491 Fountain Avenue. During the same period, she called Mr. Sinatra 16 times at the Cal-Neva Lodge in Lake Tahoe, Nev., which he then owned.

70 Telephone Calls

Seven months before these calls, in November 1961, the F.B.I. found out that Mrs. Campbell had made two phone calls to the White House. They were followed by a third call early the following February. (The Senate committee found White House records showing that Mrs. Campbell had called a total of 70 times, but initially the F.B.I. knew of only three calls.)

On Feb. 27, 1962, J. Edgar Hoover, then director of the F.B.I., sent a memorandum to Attorney General Kennedy and to Kenneth O'Donnell, then special assistant to President Kennedy, saying that an investigation of Mr. Roselli disclosed that he had been in touch with a Judith Campbell. The memo also said that Mrs. Campbell was maintaining a relationship with Sam Giancana, "a prominent Chicago underworld figure," and that Mrs. Campbell had made calls to the White House from her home in Los Angeles.

It is not known how Robert Kennedy reacted to the memorandum, but a high official in the Justice Department at that time said that his staff did not take it very seriously.

"By that time a lot of stories were coming out of the Secret Service about the President's interest in women," one former official said. "We looked on it as a domestic matter and, as I recall, the whole thing was referred to Carmine Bellino, who handled personal stuff for the President."

Kennedy-Hoover Lunch

Another former Justice Department official also said that the matter was referred to Mr. Bellino, who was then a special consultant to the President. But Mr. Bellino said in an interview that he never heard of Mrs. Campbell until the recent articles in the press about her.

"The only personal matter I ever handled for the President was once when Jackie was spending too much money and he asked me to find out where it was all going," Mr. Bellino said.

The contradiction between the former Justice Department officials' recollections and Mr. Bellino's statement was never confronted by the Senate committee. The Justice officials who recall the matter being turned over to Mr. Bellino were not questioned under oath by the committee, but merely interviewed by staff members, whom they did not tell about Mr. Bellino.

Mr. Bellino, too, was never questioned under oath, but was merely interviewed at the committee's offices.

On March 22, less than a month after the Hoover memo was sent, President Kennedy and Mr. Hoover had lunch together, the Senate committee's report said. "According to White House logs," the report added, "the last contact between the White House and the President's friend [Mrs. Campbell] occurred a few hours after the lunch session."

However, Mrs. Campbell said in her book outline that her relationship with the President continued for several months after that.

In the months following Mr. Hoover's memorandum of Feb. 27, the Justice Department received further information from the F.B.I. about Mrs. Campbell's close relationships with Mr. Giancana, Mr. Roselli and Mr. Sinatra.

The information was included in a series of reports prepared by Dougald McMillan, a Justice Department attorney studying the involvement of Mr. Sinatra with Mafia figures.

Mr. McMillan is still with the department and refused to discuss the matter, but former Justice officials who saw the reports said that they strongly recommended that Mrs. Campbell's relationships with the Mafia and with Mr. Sinatra be investigated.

Testimony Urged

They said that one of the reports urged that Mrs. Campbell be brought before a Federal grand jury, given immunity from prosecution and compelled to testify under oath about her Mafia contacts.

No action was taken on any of the recommendations by the Justice Department. Several officials who were asked about them said they did not remember reports specifically mentioning Mrs. Campbell.

But they said they did remember that several reports on Mr. Sinatra were prepared at the time, and it was in some of those reports that the recommendations about Mrs. Campbell were included.

Involvement in Plots

The Times investigation found no law-enforcement official who investigated Mr. Giancana and Mr. Roselli who could offer any evidence that they used the knowledge of Mrs. Campbell's friendship with Prime Minister Castro. President Kennedy to their advantage.

In view of these two discoveries and what Robert Kennedy later learned about Mrs. Campbell in the Sinatra reports, some of Mr. Kennedy's former associates at the Justice Department believe that he told the President what he knew about Mr. Giancana, the C.I.A. plots and Mrs. Campbell.

"He had to; he told Jack everything," one of the former associates said.

But others feel that he did not inform President Kennedy.

"Any man would tell his brother, one would suppose," said Herbert J. Miller, who was head of the Justice Department's Criminal Division under Attorney General Kennedy. "But you must remember that the C.I.A. lied to Bobby and told him the plots against Castro had been terminated. So there was no compelling need to tell the President."

That the C.I.A. lied to Robert Kennedy about ending the assassination plots against Mr. Castro was confirmed in the committee's report through testimony from former C.I.A. officials.

Even if President Kennedy learned everything his brother knew about Mrs. Campbell and her Mafia friends, however, there is no evidence available to indicate that his relationship with her benefited them.

Wiretaps on Mr. Giancana and Mr. Roselli, as well as underworld informants who were close to them, confirm that they boasted about their relationship with Mrs. Campbell. But neither of these sources offer any indication that the two Mafia figures received any benefits from the Government as a result of what they knew about her, as they did for their involvement with the C.I.A., which once intervened to block their indictment on wiretap charges.

Our Miami office advises that John Roselli, member of the Chicago "family" of LCN left his sister's residence 7/28/76, and has not been heard from since that time. He had no baggage or extra clothes and was expected to return the evening of 7/28/76. The sister believes that Roselli may have met with foul play.

According to sources, Roselli is the most powerful and influential member of LCN on the West Coast. He had been especially close to LCN "boss" Sam Giancana, who was murdered in June, 1975. Giancana and Roselli were reportedly involved in a plot with the CIA to assassinate Fidel Castro, Prime Minister of Cuba. In June, 1975, John Roselli testified before the Senate Special Investigative Committee chaired by Senator Frank Church. His testimony related to his relationship with the CIA. Los Angeles and Miami are contacting appropriate informants concerning Roselli's disappearance and you will be kept advised.

- 1 - Mr. Held
- 1 - Mr. Adams
- 1 - Mr. Gallagher
- 1 - Mr. Leavitt
- 1 - Mr. Moore

Handwritten initials/signature

PDS:rar

APPROVED:	Ext. Affairs.....	Laboratory.....
Assoc. Dir.....	Fin. & Pers.....	Legal Coun.....
Dep. AD Adm.....	Gen. Inv.....	Plan. & Eval.....
Dep. AD Inv.....	Ident.....	Rec. Mgnt.....
Asst. Dir.:	Inspection.....	Spec. Inv.....
Adm. Serv.....	Intell.....	Training.....

KV

8/5/76
GENERAL INVESTIGATIVE DIVISION

Reference is made to R. J. Gallagher memo to Mr. Adams dated 8/4/76, which reported a call the Director received from U. S. Senator Howard Baker on 8/3/76, concerning the disappearance of John Roselli, who last testified before the original Senate Select Committee on 4/23/76, regarding plots to assassinate Fidel Castro. Senator Baker felt the Senate Committee on Intelligence has a continuing interest in Roselli and felt there was a possible Obstruction of Justice (because of his disappearance). AAG Thornburgh was briefed and advised there does not appear to be a Federal violation involved but requested Roselli's brother in-law (Joseph Daigle) be interviewed concerning his knowledge of Roselli and his location of Roselli's car on 7/30/76. ✓

Attached from Miami Office advises Daigle, supra, interviewed and he (Daigle) last heard from Roselli 7/28/76, when Roselli left Daigle's residence (Plantation, Florida) wherein Roselli also resides. Daigle notified attorney David Walters (who represents Roselli in deportation proceedings) on 7/30/76. Daigle was advised by Walters to check hospitals, morgues, and the airport. Walters then offered to contact Sheriff, Broward County, Florida. Daigle recalled that Roselli had said in jest that if he was ever missing to check the parking lot of the airport. Daigle located Roselli's car at Miami Airport 7:00 p.m., 7/30/76, and then notified attorney Walters. Daigle states Roselli generally stayed close to his residence and could offer no reason for his disappearance. ✓

The Department is being advised. ✓

- 1 - Mr. Held
- 1 - Mr. Adams
- 1 - Mr. Fehl
- 1 - Mr. Mintz
- 1 - Mr. Moore

JBL:pdh

APPROVED: _____	Ext. Affairs _____	Laboratory _____
Assoc. Dir. _____	Fin. & Pers. _____	Legal Coun. _____
Dep. AD Adm. _____	Gen. Inv. _____	Plan. & Eval. _____
Dep. AD Inv. _____	Ident. _____	Rec. Mgmt. _____
Asst. Dir. _____	Intelligence _____	Spec. Inv. _____
Adm. Serv. _____	Intch. _____	Training _____

JBL

Memorandum

TO : Mr. Gallagher *[Signature]*

DATE: 8/18/76

FROM : L. E. Rhyne *[Signature]*

SUBJECT: UNKNOWN SUBJECT;
JOHN ROSELLI - VICTIM
OBSTRUCTION OF JUSTICE

- 1 - Mr. Held
- 1 - Mr. Adams
- 1 - Mr. Gallagher
- 1 - Mr. O'Connell
- 1 - Mr. Rhyne
- 1 - Mr. Fisher
- 1 - Mr. Fehl
- 1 - Mr. Mintz
- 1 - Mr. Moore

- Dep. AD Adm.
- Dep. AD Inv.
- Asst. Dir.:
- Adm. Serv.
- Ext. Affairs
- Fin. & Pers.
- Gen. Inv.
- Ident.
- Inspection
- Intell.
- Laboratory
- Legal Coun.
- Plan. & Eval.
- Rec. Mgnt.
- Spec. Inv.
- Training
- Telephone Rm.
- Director Sec'y

PURPOSE: This is to advise of the up-to-date status of investigation in this matter.

RECOMMENDATION: For information.

[Handwritten initials/signature]

APPROVED <i>[Signature]</i>	Ext. Affairs	Laboratory
Assoc. Dir.	Fin. & Pers.	Legal Coun.
Dep. AD Adm.	Gen. Inv.	Plan. & Eval.
Dep. AD Inv.	Ident.	Rec. Mgnt.
Asst. Dir.:	Inspection	Spec. Inv.
Adm. Serv.	Intell.	Training

DETAILS: Dade County Public Safety Department, Miami, Florida, advised that U. S. Senator Gary Hart, Colorado, member of the Senate Select Committee on Intelligence, accompanied by Committee Counsels Rick Inderforth and Michael Madigan, is expected to contact the Dade County Public Safety Department on 8/20/76 for the purpose of discussing Roselli's testimony before the Senate Select Committee on Intelligence. Senator Hart is expected to verbally brief the homicide investigators.

67D
OS

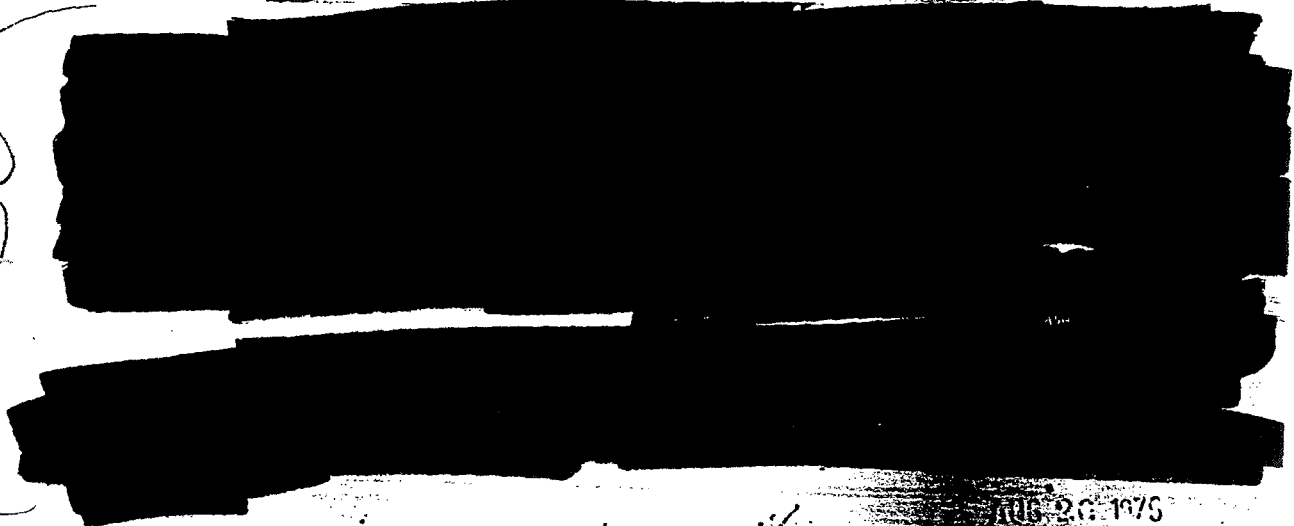

GEF:cmv (10)
92-3267

NOT RECORDED
191

AUG 26 1976
CONTINUED OVER

Buy U.S. Savings Bonds Regularly on the Payroll Savings Plan

MA
8-11-76
EJS

FEDERAL BUREAU OF INVESTIGATION
COMMUNICATIONS SECTION

AUG 10 1976
SJP
TELETYPE

Assoc. Dir.	_____
Dep.-A.D.-Adm.	_____
Dep.-A.D.-Inv.	_____
Asst. Dir.:	
Adm. Serv.	_____
Ext. Affairs	_____
Fin. & Pers.	_____
Gen. Inv.	_____
Ident.	_____
Inspection	_____
Intell.	_____
Laboratory	_____
Legal Coun.	_____
Plan. & Eval.	_____
Rec. Mgmt.	_____
Spec. Inv.	_____
Training	_____
Telephone Rm.	_____
Director Sec'y	_____

PLU

NR 005 LV PLAIN

836 PM NITEL AUGUST 10, 1976 AAH

TO DIRECTOR, FBI (92-3267)

FROM LAS VEGAS (92-467) (P)

ATTN: SPECIAL INVESTIGATIVE DIVISION.

JOHN ROSELLI, AKA. AR. OO: LOS ANGELES.

REBUTELCALL, AUG. 10, 1976, AND LOS ANGELES TEL, AUG. 10, 1976. U

CONTACT WITH SOURCES, LAS VEGAS DIVISION, REFLECTS NO PERTINENT INFORMATION OF VALUE RELATIVE TO ROSELLI'S MURDER. U

SOURCES, LAS VEGAS DIVISION, IN THE EARLY 1970S WHILE ROSELLI WAS IN PRISON, INDICATED THAT ROSELLI HAD MADE SOME DEROGATORY STATEMENTS CONCERNING SOME OF HIS FORMER ASSOCIATES IN CHICAGO AND DETROIT AND THAT AS A RESULT ROSELLI'S FORMER ASSOCIATES WERE EXTREMELY UPSET WITH HIM AND WAS PROBABLY CONTEMPLATING TAKING SOME ACTION AGAINST HIM WHEN HE WAS RELEASED FROM JAIL. U

EX-108 REC-42 92-3267-1062

X

22 AUG 11 1976

b7C

[REDACTED]

MENTIONED RE LOS ANGELES TEL,

b7D

CURRENTLY RESIDES LAS VEGAS [REDACTED]

58 AUG 20 1976

g Smith

[REDACTED]

b7c
b7D

[REDACTED] HAS BEEN CONTACTED TWICE SINCE FIRST NEWS REPORT OF ROSELLI'S DISAPPEARANCE. ON AUG. 9, 1976, [REDACTED] STATED HE HAD HAD NO CONTACT OR DIRECT INFORMATION FROM ROSELLI SINCE HE WAS RELEASED FROM JAIL. [REDACTED] STATED THAT HE KNOWS OF NO ONE IN LAS VEGAS WHO HAS BEEN CLOSE TO ROSELLI SUESEQUENT TO HIS RELEASE FROM PRISON WITH THE POSSIBLE EXCEPTION OF JOE BREEN, ONE THIRD OWNER OF THE GIFT SHOP IN THE FRONTIER HOTEL WITH ROSELLI. [REDACTED] FURTHER STATED THAT HARRIET HAMILTON IN THE LAW FIRM OF FOSTON, HAMILTON, AND FENSTER, BEVERLY HILLS, CALIFORNIA, WOULD BE THE INDIVIDUAL WHO WOULD HAVE MOST COMPLETE KNOWLEDGE OF ROSELLI'S ACTIVITIES DURING THE PAST COUPLE OF YEARS. U

b7c
b7D

LV 92-467 PAGE THREE

[REDACTED] STATED HE HAS NO SPECIFIC IDEA AS TO REASON
FOR ROSELLI'S DEATH BUT STATED IN HIS OWN MIND HE BELIEVES
IT IS A RESULT OF HIS TESTIMONY BEFORE A SENATE COMMITTEE
ON THE ALLEGED PLOT TO KILL CASTRO [REDACTED]

[REDACTED]

b7C
b7
09

CHICAGO, DETROIT, LOS ANGELES, MIAMI, AND SAN DIEGO
ADVISED BY AIR MAIL. U
END.

FEDERAL BUREAU OF INVESTIGATION
COMMUNICATIONS SECTION

Assoc. Dir.	_____
Dep.-A.D.-Adm.	_____
Dep.-A.D.-Inv.	_____
Asst. Dir.:	
Adm. Serv.	_____
Ext. Affairs	_____
Fin. & Pers.	_____
Gen. Inv.	_____
Ident.	_____
Inspection	_____
Intell.	_____
Laboratory	_____
Legal Coun.	_____
Plan. & Eval.	_____
Rec. Mgnt.	_____
Spec. Inv.	_____
Training	_____
Telephone Rm.	_____
Director Sec'y	_____

AUG 4 1976

TELETYPE

NR020 MM PLAIN

8:09PM NITEL AUGUST 4, 1976 JGS

TO DIRECTOR (92-3267)

FROM MIAMI (92-517) (P)

ATTENTION: GENERAL INVESTIGATIVE DIVISION.

JOHN ROSELLI, AKA, AR, OO: LOS ANGELES.

RE MIAMI TELETYPE TO THE BUREAU, DATED AUGUST 3, 1976.

SUBJECT'S BROTHER-IN-LAW, JOSEPH DAIGLE, ADVISED JULY 30, 1976, INFORMED ATTORNEY DAVID WALTERS, MIAMI, FLORIDA, THAT ROSELLI HAD NOT BEEN HEARD FROM SINCE HE LEFT DAIGLE'S RESIDENCE ON THE AFTERNOON OF JULY 28, 1976. WALTERS THEN SUGGESTED THAT DAIGLE CALL ATTORNEY HARRIET HAMILTON IN LOS ANGELES, CALIFORNIA, WHO REPRESENTED SUBJECT IN THAT AREA, TO DETERMINE IF SHE HAD ANY INFORMATION CONCERNING ROSELLI'S WHEREABOUTS. IN VIEW OF THE CIRCUMSTANCES, WALTERS ALSO SUGGESTED A CHECK OF HOSPITALS AND MORGUES IN THE MIAMI AREA. WALTERS THEN OFFERED TO CONTACT SHERIFF ED STACK, SHERIFF OF BROWARD COUNTY, FT. LAUDERDALE, FLORIDA, AND HAVE HIS OFFICE CHECK THE MORGUES AND HOSPITALS TO WHICH DAIGLE AGREED. WALTERS ALSO SUGGESTED A CHECK OF THE AIRPORT AND BOTH MR. AND MRS. DAIGLE AT THAT TIME RECALLED THAT ROSELLI HAD SAID IN JEST, THAT IF HE WAS EVER MISSING, TO CHECK THE PARKING LOT OF THE

REC-51 92-3267-1067

SMITH
DUGAN

58 AUG 24 1976

100

PAGE TWO (MM 92-517)
AIRPORTS, A COMMON LOCATION FOR THE UNDERWORLD TO ABANDON CARS
USED IN CRIMES, INCLUDING MURDERS. U

DAIGLE CHECKED THE FT. LAUDERDALE AIRPORT AND MIAMI
AIRPORT WHERE HE LOCATED THE CAR ROSELLI WAS DRIVING, AT
7:00 P.M., JULY 30, 1976. HE THEN NOTIFIED ATTORNEY WALTERS
OF THE LOCATION OF THE CAR. U

JOSEPH DAIGLE WAS INTERVIEWED ON AUGUST 3, 1976, AND
STATED THAT ROSELLI HABITUALLY STAYED WITHIN THE CONFINES
OF THE DAIGLE RESIDENCE, PLANTATION, FLORIDA, AND SPECIFICALLY
SPENT MOST OF HIS TIME IN THE PATIO READING NUMEROUS PUBLICA-
TIONS. HE SOCIALIZED ONLY WITH THE DAIGLES BY EATING OUT IN
RESTAURANTS IN THE AREA, WHICH WERE CHOSEN BY THE DAIGLES.
HE SAID ROSELLI WAS NOT A BAR-HOPPER, DID NOT FREQUENT ANY
ONE RESTAURANT HABITUALLY, AND DID NOT KEEP LATE HOURS.
HE REMAINED IN THE DAIGLE RESIDENCE USUALLY WATCHING TV
DURING THE EVENING. ON OCCASION, WHEN ROSELLI DID LEAVE THE
DAIGLE RESIDENCE, IT WAS FOR SHOPPING TRIPS AND RUNNING ERRANDS
FOR HIS SISTER. HE OCCASIONALLY VISITED HIS LAWYER, DAVID
WALTERS IN MIAMI, FLORIDA. DAIGLE RECALLED HE ALSO TRAVELLED

PAGE THREE (MM 2-517)

TO WASHINGTON, D.C. TO CONTACT HIS ATTORNEY THOMAS WADDEN.
ROSELLI WAS IN THE LOS ANGELES AREA IN JANUARY, 1976, WHERE HE
WAS IN CONTACT WITH HIS ATTORNEY HARRIET HAMILTON, AND HAD A
CHECKUP IN A MEDICAL CLINIC IN SANTA BARBARA, CALIFORNIA. u

DAIGLE EMPHASIZED THAT ROSELLI DID NOT DISCUSS HIS AFFAIRS
WITH DAIGLE OR MRS. DAIGLE. ROSELLI HAD HIS OWN ROOM, WHICH
WAS EQUIPPED WITH TV, A TELEPHONE EXTENSION, AND WAS ADJACENT
TO THE POOL-PATIO AREA, TO THE EXTENT THAT HE HAD A SEPARATE
SUITE AT THE RESIDENCE. u

DAIGLE HAD NO SPECIFICS AS TO THE REASON FOR ROSELLI'S
DISAPPEARANCE. HE FELT THAT ROSELLI'S PREVIOUS HOODLUM ACTIVITIES
PLUS BEING PUBLICLY IDENTIFIED WITH AN ALLEGED PLOT TO ASSASSINATE
FIDEL CASTRO COULD HAVE BEEN CONTRIBUTING FACTORS TO ROSELLI'S
DISAPPEARANCE. u

HE SAID BOTH HE AND MRS. DAIGLE ARE EXTREMELY PESSIMISTIC
THAT ROSELLI WOULD BE FOUND ALIVE, DUE TO THE INCREASING TIME
SPAND WITH NO COMMUNICATION FROM HIM SINCE HIS DISAPPEARANCE
ON JULY 28, 1976. u

END.

HLD

cc. [signature]

UNITED STATES GOVERNMENT ROUTE IN ENVELOPE

Memorandum

- Tolson _____
- DeLoach _____
- Mohr _____
- Wick ✓
- Casper _____
- Callahan _____
- Conrad _____
- Felt _____
- Gale _____
- Rosen ✓
- Sullivan ✓
- Tavel _____
- Trotter _____
- Tele. Room _____
- Holmes _____
- Gandy _____

TO : W. C. Sullivan

DATE: March 6, 1967

FROM : W. R. Wannall

- 1 - Mr. Sullivan
- 1 - Mr. Papich
- 1 - Mr. Wannall
- 1 - Inspector

SUBJECT: CENTRAL INTELLIGENCE AGENCY'S INTENTIONS TO SEND HOODLUMS TO CUBA TO ASSASSINATE CASTRO

Classified by 6049
 Exempt from GDS, Category 2
 Date of Declassification Indefinite
 11/23/77
 [Signature]

~~TOP SECRET~~

In accordance with instructions, attached letter has been prepared for Attorney General setting forth all data in our files concerning captioned matter. Briefly, information being furnished is as follows: u

Matter first came to our attention in Spring of 1961 in connection with our investigation of violation of Unauthorized Publication or Use of Communications Statute on the part of Arthur James Balletti, arrested in Las Vegas, Nevada, by local authorities on wire tapping charge. Wire tap involved was on telephone of Jan Rowan, member of Rowan and Martin comedy team. Rowan at the time reportedly was engaged to Phyllis McGuire, girl friend of top hoodlum Sam Giancana and member of McGuire Sisters singing trio. u

Through our investigation we determined involvement of Robert A. Maheu, private detective, who stated coverage on Rowan instituted in behalf of Central Intelligence Agency (CIA) efforts to obtain Cuban intelligence data through hoodlum element, including Sam Giancana. Maheu was in contact with Giancana through services of John Roselli, another hoodlum, and Maheu authorized wiring of Rowan's room.

We checked matter with CIA on 5/3/61 and learned CIA was utilizing Maheu as intermediary with Sam Giancana relative to CIA's "dirty business" anti-Castro activities. CIA insisted it did not give Maheu any instructions relative to use of technical installations. By letter 5/22/61 we furnished former Attorney General Kennedy a memorandum containing a rundown on CIA's involvement in this. The originals of the letter and memorandum were returned to us for filing purposes. A copy of that memorandum is being attached to instant letter being sent to Attorney General. (S)(u)

On 5/9/62 Kennedy discussed with the Director a number of matters, including admission by CIA that Robert Maheu had been

61-108-23-1967 3-6-67
GCM:ams
(8)

CONTINUED - OVER

92-3267
NOT RECORDED
MAR 14 1967
MAR 13 1967

~~TOP SECRET~~

LATIN-AMERICAN

8/2/80
 * CIA Info Declassed per John C. Bacon
 22,330
 3/2/81
 SP4-Jun/Kan
 70-108-23-1967

Memorandum for Mr. Sullivan
Re: CENTRAL INTELLIGENCE AGENCY'S
INTENTIONS TO SEND HOODLUMS TO
CUBA TO ASSASSINATE CASTRO

~~TOP SECRET~~

hired by that Agency to approach Sam Giancana to have Castro assassinated at a cost of \$150,000. Kennedy stated he had issued orders that CIA should never undertake such steps again without first checking with Department of Justice and stated because of this matter it would be difficult to prosecute Giancana or Maheu then or in the future.

We learned on 6/20/63 from CIA that its contacts with John Roselli (Maheu's link with Giancana) had continued up until that time, when they were reportedly cut off.

It appears Roselli is using his prior connections with CIA to his best advantage. In May, 1966, when Bureau Agents endeavored to interview him he immediately flew to Washington and informed his former CIA intermediary. The current Director of Security, CIA, has advised through liaison channels that Roselli has CIA in an unusually vulnerable position and Roselli would have no qualms about embarrassing CIA to serve his own interests. In furnishing this information we were asked that it be held within this Bureau on a strictly need-to-know basis. We have, however, included it in the attached proposed letter to the Attorney General noting this CIA specific restriction. X(u)

We have two other references in our files to the over-all above information which we have included in the letter. One relates to a statement by Giancana in October, 1960, that he had met with an individual who was to assassinate Castro in November, 1960. The other is an article in the 8/16/63 issue of the "Chicago Sun Times" reporting that CIA agents had contacted Giancana to obtain Cuban intelligence.

ACTION:

If approved, attached letter will be sent to the Attorney General, with a copy for the Deputy Attorney General. U

gen
~~TOP SECRET~~

WCS
The Attorney General
asked for this information
on Friday, 3/3/67.
[Signature]

FEDERAL BUREAU OF INVESTIGATION
FREEDOM OF INFORMATION/PRIVACY ACTS SECTION

SUBJECT: FIDEL CASTRO

FILE NUMBER: 62-116464 CROSS-REFERENCES

- 1 - Mr. J. B. Adams
- 2 - Mr. J. A. Mintz
(1 - Mr. J. B. Rotis)
- 1 - Mr. W. R. Wannall

September 10, 1975

The Attorney General

Director, FBI

- 1 - Mr. W. O. Cregar
- 1 - Mr. T. J. McNiff

UNITED STATES HOUSE SELECT COMMITTEE
ON INTELLIGENCE ACTIVITIES (HSC)

ALL INFORMATION CONTAINED
HEREIN IS UNCLASSIFIED ^{302/2} 422,330
DATE 3/16/81 BY SP4 Qm/Koz

Reference is made to HSC letter dated July 22, 1975, requesting materials and documents previously provided to the United States Senate Select Committee on Intelligence Activities (SSC). u

Enclosed for your approval and forwarding to the HSC is the original of a memorandum with enclosure which is submitted as a partial response to the above-cited request of the HSC. u

It is noted that, in addition to the attached documents, material concerning the 1964 Democratic National Convention was made available to Mr. Richard Verniere, HSC Staff Member, on August 25, 1975, for review. Mr. Verniere requested the HSC be furnished with this material. u

On August 21, 1975, the Deputy Special Counsel for Intelligence Coordination, Steven Blackhurst, advised Special Agent Paul V. Daly of this Bureau that the HSC was not to receive any material concerning the 1964 Democratic National Convention. Accordingly, those specific documents are not included with the attached. u

A copy of this memorandum is being furnished for your records. u

- Assoc. Dir. _____
- Dep. AD Adm. _____
- Dep. AD Inv. _____
- Asst. Dir.:
- Admin. _____
- Comp. Syst. _____
- Ext. Affairs _____
- Files & Com. _____
- Gen. Inv. _____
- Ident. _____
- Inspection _____
- Intell. _____
- Laboratory _____
- Plan. & Eval. _____
- Spec. Inv. _____
- Training _____
- Legal Coun. _____
- Telephone Rm. _____
- Director Sec'y _____

ENCLOSURE
62-116464

TOP SECRET MATERIAL ATTACHED

The Deputy Attorney General
Attention: Michael E. Shaheen, Jr.
Special Counsel for
Intelligence Coordination

MJD:mjg/lhb
(10)

MAIL ROOM TELETYPE UNIT

84 NOV 6 1975

GPO 554

Handwritten notes and stamps:
 REF 17
 15 NOV 5 1975
 62-116464-54X
 ENCLOSURE
 ENCL. ROOM
 TOP SECRET MATERIAL ATTACHED
 UNCL. Release to HSC 10/2/75
 PUS
 WOC
 EWS
 This is duplicate of attached
 ENCL. ROOM
 ENCL. ROOM

- 1 - Mr. B. Adams
- 2 - Mr. J. A. Mints
(1 - Mr. J. B. Hotis)
- 1 - Mr. W. R. Wannall
- 1 - Mr. W. O. Cregar
- 1 - Mr. T. J. McNiff

62-116464

September 10, 1975

**U. S. HOUSE SELECT COMMITTEE
ON INTELLIGENCE ACTIVITIES (HSC)**

**RE: REQUEST FOR ALL INFORMATION
PREVIOUSLY MADE AVAILABLE BY
THE FBI TO THE SENATE SELECT
COMMITTEE (SSC)**

ALL INFORMATION CONTAINED
HEREIN IS UNCLASSIFIED
DATE 3/16/81 BY SP4 Jmm/Kcw

*CIA info unclassified per
John E. Bacon 8/27/80*

Reference is made to HSC letter dated July 22, 1975, requesting that the HSC be furnished copies of all documents and materials provided by the FBI to the SSC. Pursuant to an agreement reached August 19, 1975, by representatives of this Bureau, the Department of Justice and the HSC, all such material is being made available to HSC Staff Members for review at FBI Headquarters, and copies of material so designated by these Staff Members will be processed for delivery to the HSC.

On August 25, 1975, upon completion of a partial review of the material previously furnished the SSC, Richard Verniers, HSC Staff Member, requested that the HSC be furnished with documents previously given to SSC in the following categories:

I. Liaison Functions;

II. [REDACTED]

III. [REDACTED]

IV. Demonstration at Federal Building, Akron, Ohio.

January 27, 1975;

AJD:mjg/lhb/lb
(9)

ORIGINAL AND ONE COPY TO AG

TOP SECRET MATERIAL ATTACHED

SEE NOTE PAGE 2

62-116464-54X Per

- Assec. Dir. _____
- Dep. AD Adm. _____
- Dep. AD Inv. _____
- Asst. Dir.:
- Admin. _____
- Comp. Syst. _____
- Ext. Affairs _____
- Files & Com. _____
- Gen. Inv. _____
- Ident. _____
- Inspection _____
- Intell. _____
- Laboratory _____
- Plan. & Eval. _____
- Spec. Inv. _____
- Training _____
- Legal Coun. _____
- Telephone Rm. _____
- Director's Sec'y _____

MAIL ROOM

TELETYPE UNIT

ENCLOSURE

copy 57C 65

*WAC
EWS*

*WAC
EWS*

U. S. HOUSE SELECT COMMITTEE ON INTELLIGENCE ACTIVITIES (HSC)

**RE: REQUEST FOR ALL INFORMATION PREVIOUSLY MADE AVAILABLE BY
THE FBI TO THE SENATE SELECT COMMITTEE (SSC)**

V. Electronic Devices;

**VI. Investigation of Ku Klux Klan and other
Hate Groups;**

VII. Suggested Name Change, Crime Records Division;

**VIII. CIA's Contact with Hoodlums Regarding
Castro Assassination;**

**IX. Foreign Support for Revolutionary Protest
Movements in the United States;**

**X. Departmental Letters Concerning Electronic
Surveillance Activities.**

In compliance with this request, attached are the
requested documents.

Enclosure

1 - The Attorney General

NOTE:

This material, which is being furnished the HSC, is material previously furnished the SSC in response to their request of 5/14/75, Appendixes C, Item 10; Appendix B, Items 13 and 14; Appendix D, Items 6 and 2; Appendix A, Item 5(d); Appendix B, Part II, Items 12 and 15. Also, a portion of the material furnished in response to the SSC 5/12/75 request, att. 6/25/75 to the 5/14/75 request, and Appendix B, Item 4(a and b). This material was among documents which were reviewed by Richard Verniere, HSC Staff Member, on 8/25/75, and following this review, he requested copies of these particular documents.

U. S. HOUSE SELECT COMMITTEE ON INTELLIGENCE ACTIVITIES (HSC)

**RE: REQUEST FOR ALL INFORMATION PREVIOUSLY MADE AVAILABLE BY
THE FBI TO THE SENATE SELECT COMMITTEE (SSC)**

NOTE CONTINUED:

No mention is being made in the LHM of the withheld documents concerning the 1964 Democratic National Convention. Since this was a Departmental decision, any inquiry received from HSC concerning same will be referred to the Department for response.

5-140 (Rev. 1-21-74) FEDERAL BUREAU OF INVESTIGATION
WASHINGTON, D. C. 20535

House Select Committee

Addressee: _____

LTR LHM Memo Report dated 9/11/75

Caption of Document: Re HSC let dated 7/22/75 which requested all materials previously provided to SSC.

Originating Office: FBI 257

Delivered by: Richard T. Taylor Date: 10/2/75

Received by: Reginald Hess

Title: Resnick Dir.

Return this receipt to the Intelligence Division, FBI

ALL INFORMATION CONTAINED
HEREIN IS UNCLASSIFIED ^{702/10/81} 23,330
DATE 3/16/81 BY SP4 Gm/Kan

62-116464-54X

ENCLOSURE

TO: Intelligence Community Staff ATTN: Central Index		FROM: FBI	
SUBJECT: Abstract of Information Provided to Select Committees			
1. HOW PROVIDED (check appropriate term. If a document was made available for review but not transmitted, so note.)			2. DATE PROVIDED
<input checked="" type="checkbox"/> DOCUMENT	<input type="checkbox"/> BRIEFING	<input type="checkbox"/> INTERVIEW	<input type="checkbox"/> TESTIMONY
<input type="checkbox"/> OTHER	9/11/75		
3. TO WHOM PROVIDED (check appropriate term; add specific names if appropriate)			
<input type="checkbox"/> SSC	CIA Info unclass Per John E. Bacon 8/27/80 ALL INFORMATION CONTAINED HEREIN IS UNCLASSIFIED DATE 3/16/81 BY SP4-Jmm/Kda 7052, 330		
<input checked="" type="checkbox"/> HSC			
4. IDENTIFICATION (provide descriptive data for documents; give name or identification number of briefer, interviewee, testifier and subject)			
Memorandum and enclosures			
5. IN RESPONSE TO (list date and item number if in response to formal request, otherwise state verbal request of (name), initiative, subpoena, etc.)			6. CLASSIFICATION OF INFORMATION (enter U, C, S, TS or Codeword)
HSC letter 7/22/75			TS
7. KEY WORDS (enter the appropriate key words from the list provided separately; if key words not listed are used underline for emphasis)			
Intelligence collection Surveillance, electronic Information handling			
8. SEE (reverse side before completing this item)			
HSC requested that they be furnished with documents previously given to SSC in the following categories: Liaison functions;			
[REDACTED]			
Demonstration at Federal Bldg Akron, Ohio 1/27/75; Electronic devices; Investigation of Ku Klux Klan and other Hate Groups; Suggested Name Change, Crime Records Division; CIA's Contact with Hoodlums Regarding Castro Assassination; Foreign Support for Revolutionary Protest Movements in the United States; Departmental Letters Concerning Electronic Surveillance Activities.			
62-116464 FK:fk (4)		TREAT AS YELLOW ORIGINAL VIA LIAISON TO CENTRAL COMMUNITY INDEX IN CONNECTION WITH HOUSTUDY	

INSTRUCTIONS

- Type or print clearly in ink.
- Indicate classification of the abstract top and bottom.
- Date the abstract and put on any internal control numbers required.
- "FROM" entry should clearly identify the organization providing the information.
- If additions (as when a copy of document sent to SSC is later sent to HSC) or changes to a previously submitted form are necessary, submit a copy of the original abstract, with the change indicated.

SPECIFIC ITEM NO. 8. SUMMARY - enter brief narrative statement describing substance of information and showing relationship to Intelligence Community matters if appropriate. Any feedback or evidence of investigatory interests should be noted. Commitments made to supply additional information should be noted. Additionally, certain administrative information may be entered here, e.g., restrictions on review of a document, if document was paraphrased, whether interviewee is current or former employee, etc. If actual document or transcript is provided, that fact should be noted and no summary is required. Additional pages may be attached if necessary.

62-116464-54X

encl 17

AJD:mjg/lhb 9/11/75

The Attorney General U.S. HOUSE SELECT COMMITTEE
ON INTELLIGENCE ACTVS (HSC)

K.Y.

ReHSClet 7/22/75 req'ng materials & documts previously provided SSC. Enclsd for ur aprvl & forwrd to HSC is orig of memo w/enclsr sbmtd as partial resps to abv-cited req of HSC. It noted that material cnrng 1964 Democratic Natnal Convntn made avail to Richard Vermiere, HSC, 8/25/75, for revw. He req'd furnshng this material. On 8/31/75, Deputy Specl Counsl for Intel Coordtn advsd Bu not to give material, & not included. CC for u.

VIII. CIA'S CONTACT WITH HOODLUMS REGARDING
CASTRO ASSASSINATION

ALL INFORMATION CONTAINED
HEREIN IS UNCLASSIFIED ^{FOIPA}
DATE 3/16/81 BY SP4-gmm/KDW #22,330

CIA Info unclassified per
John E. Bacon 8/27/80

UNITED STATES GOVERNMENT
ROUETTE IN
Memorandum

TO : W. C. Sullivan

DATE: March 6, 1967

FROM : W. R. Wannall (WRA)

*CIA info unclassified per
JOHN E. BROWN 8/27/80
1*

SUBJECT: CENTRAL INTELLIGENCE AGENCY'S
INTENTIONS TO SEND HOODLUMS TO
CUBA TO ASSASSINATE CASTRO

ALL INFORMATION CONTAINED
HEREIN IS UNCLASSIFIED *FOIA 22, 220*
DATE 3/2/81 BY SP4 GJM/KZ

In accordance with instructions, attached letter has been prepared for Attorney General setting forth all data in our files concerning captioned matter. Briefly, information being furnished is as follows:

Matter first came to our attention in Spring of 1961 in connection with our investigation of violation of Unauthorized Publication or Use of Communications Statute on the part of Arthur James Balletti, arrested in Las Vegas, Nevada, by local authorities on wire tapping charge. Wire tap involved was on telephone of Dan Rowan, member of Rowan and Martin comedy team. Rowan at the time reportedly was engaged to Phyllis McGuire, girl friend of top hoodlum Sam Giancana and member of McGuire Sisters singing trio.

Through our investigation we determined involvement of Robert A. Maheu, private detective, who stated coverage on Rowan instituted in behalf of Central Intelligence Agency (CIA) efforts to obtain Cuban intelligence data through hoodlum element, including Sam Giancana. Maheu was in contact with Giancana through services of John Roselli, another hoodlum, and Maheu authorized wiring of Rowan's room.

We checked matter with CIA on 5/3/61 and learned CIA was utilizing Maheu as intermediary with Sam Giancana relative to CIA's "dirty business" anti-Castro activities. CIA insisted it did not give Maheu any instructions relative to use of technical installations. By letter 5/22/61 we furnished former Attorney General Kennedy a memorandum containing a rundown on CIA's involvement in this. The originals of the letter and memorandum were returned to us for filing purposes. A copy of that memorandum is being attached to instant letter being sent to Attorney General.

On 5/9/62 Kennedy discussed with the Director a number of matters, including admission by CIA that Robert Maheu had been

Memorandum for Mr. Sullivan
Re: CENTRAL INTELLIGENCE AGENCY'S
INTENTIONS TO SEND HODLUMS TO
CUBA TO ASSASSINATE CASTRO

hired by that Agency to approach Sam Giancana to have Castro assassinated at a cost of \$150,000. Kennedy stated he had issued orders that CIA should never undertake such steps again without first checking with Department of Justice and stated because of this matter it would be difficult to prosecute Giancana or Maheu then or in the future.

We learned on 6/20/63 from CIA that its contacts with John Roselli (Maheu's link with Giancana) had continued up until that time, when they were reportedly cut off.

It appears Roselli is using his prior connections with CIA to his best advantage. In May, 1966, when Bureau Agents endeavored to interview him he immediately flew to Washington and informed his former CIA intermediary. The current Director of Security, CIA, has advised through liaison channels that Roselli has CIA in an unusually vulnerable position and Roselli would have no qualms about embarrassing CIA to serve his own interests. In furnishing this information we were asked that it be held within this Bureau on a strictly need-to-know basis. We have, however, included it in the attached proposed letter to the Attorney General noting this CIA specific restriction.

We have two other references in our files to the over-all above information which we have included in the letter. One relates to a statement by Giancana in October, 1960, that he had met with an individual who was to assassinate Castro in November, 1960. The other is an article in the 8/16/63 issue of the "Chicago Sun Times" reporting that CIA agents had contacted Giancana to obtain Cuban intelligence.

ACTION:

If approved, attached letter will be sent to the Attorney General, with a copy for the Deputy Attorney General.

*The Attorney General
asked for this information
on Friday, 8/3/67.
V. [Signature]*



UNITED STATES DEPARTMENT OF JUSTICE
FEDERAL BUREAU OF INVESTIGATION

In Reply, Please Refer to
File No.

~~TOP SECRET~~

WASHINGTON 25, D. C.

May 22, 1961

ARTHUR JAMES BALLETTI, et al.

On May 3, 1961, Colonel Sheffield Edwards, Director of Security, Central Intelligence Agency (CIA) furnished the following information.

Colonel Edwards advised that in connection with CIA's operation against Castro he personally contacted Robert Maheu during the Fall of 1960 for the purpose of using Maheu as a "cut-out" in contacts with Sam Giancana, a known hoodlum in the Chicago area. Colonel Edwards said that since the underworld controlled gambling activities in Cuba under the Batista government, it was assumed that this element would still continue to have sources and contacts in Cuba which perhaps could be utilized successfully in connection with CIA's clandestine efforts against the Castro government. As a result, Maheu's services were solicited as a "cut-out" because of his possible entree into underworld circles. Maheu obtained Sam Giancana's assistance in this regard and according to Edwards, Giancana gave every indication of cooperating through Maheu in attempting to accomplish several clandestine efforts in Cuba. Edwards added that none of Giancana's efforts have materialized to date and that several of the plans still are working and may eventually "pay off."

Colonel Edwards related that he had no direct contact with Giancana; that Giancana's activities were completely "back stopped" by Maheu and that Maheu would frequently report Giancana's action and information to Edwards. No details or methods used by Maheu or Giancana in accomplishing their missions were ever reported to Edwards. Colonel Edwards said that since this is "dirty business" he could not afford to have knowledge of the actions of Maheu and Giancana in pursuit of any mission for CIA. Colonel Edwards added that he has neither given Maheu any instruction to use technical installations of any type nor has the subject of technical installations ever come up between Edwards and Maheu in connection with Giancana's activity.

DECLASSIFIED BY *SP4 GJM/KCA*
ON *3/9/81* *FBI PA #22,330*
CIA info declassified per
John E. Bacon 8/27/80

~~TOP SECRET~~

ENCLOSURE

~~TOP SECRET~~

Colonel Edwards related that Maheu did come to him concerning the arrest in Las Vegas of Balletti for "wire tapping." Maheu cautioned Edwards that the Balletti arrest could cause CIA some embarrassment since Balletti was in Las Vegas attempting to obtain coverage on some "Hollywood people" in connection with Giancana's efforts for CIA. Edwards said that he did not know the facts of the Balletti case and Maheu claims "Balletti went too far" in his efforts to obtain information. Edwards added that he was unaware of any reason for this activity of Maheu or Giancana in Las Vegas and that Giancana's activity in furtherance of the anti-Castro activity was left completely in Maheu's hands.

Colonel Edwards advised that only Mr. Bissell (Deputy Director of Plans, CIA) and two others in CIA were aware of the Giancana - Maheu activity in behalf of CIA's program and that Allen Dulles was completely unaware of Edwards' contact with Maheu in this connection. He added that Mr. Bissell, during his recent briefings of General Taylor and the Attorney General in connection with their inquiries into CIA relating to the Cuban situation, told the Attorney General that some of CIA's associated planning included the use of Giancana and the underworld against Castro.

"Property of FBI
This report and its contents are
loaned to you by the FBI, and
neither it nor its contents are
to be distributed outside the agency
to which loaned."

- 2 -

~~TOP SECRET~~

TOP SECRET
1 - [redacted]
1 - [redacted]
1 - [redacted]
1 - [redacted]

TOP SECRET IN ENVELOPE

The Attorney General

March 6, 1967

Director, FBI

CENTRAL INTELLIGENCE AGENCY'S
INTENTIONS TO SEND HOODLUMS TO
CUBA TO ASSASSINATE CASTRO

DECLASSIFIED BY SP4-Jmk/Kca
ON 3/2/81 70, 100, 122, 330
CIA Info Declassified per
John E. Bacon 8/27/80

Our files contain the following information concerning the captioned matter, much of which has been furnished by the Central Intelligence Agency (CIA) on a strictly highly confidential "need-to-know" basis. In view of this, it is requested that it be handled on a most restrictive basis.

This matter first came to our attention in the Spring of 1961 in connection with our investigation of a violation of the Unauthorized Publication or Use of Communications Statute on the part of Arthur James Balletti, who had been arrested by local authorities in Las Vegas, Nevada, on a local wire tapping charge. Balletti and another unidentified individual in October, 1960, had reportedly placed a wire tap on the telephone of Dan Rowan, a member of the comedy team of Rowan and Martin. Rowan at the time reportedly was engaged to Phyllis McGuire of the well-known McGuire Sisters singing trio who was also known to be a girl friend of Sam Giancana, a top hoodlum.

During the course of the Balletti investigation it was ascertained that Robert A. Mahou, a private detective, was involved. Mahou during interview claimed he ordered coverage of Rowan in behalf of CIA's efforts to obtain intelligence information in Cuba through the hoodlum element, including Sam Giancana, which had interests there. Mahou said he was put in contact with Giancana in connection with these intelligence activities through John Roselli, a Los Angeles hoodlum. Mahou stated also that he authorized the wiring of Rowan's room and had discussed the matter with Roselli.

The essence of the above was furnished ~~CONFIDENTIAL~~ Attorney General Robert F. Kennedy by letter dated ~~May 22, 1961~~ which enclosed a memorandum of the same date containing data made available on May 3, 1961, by Colonel Sheffield Edwards, who at that time was Director of Security at CIA, regarding his utilization of Mahou in connection with anti-Castro activities. Since our files show that Mr. Kennedy returned the original of our letter and its enclosed memorandum dated May 22, 1961,

~~TOP SECRET~~ GROUP 1
Excluded from automatic
downgrading and
declassification

The Attorney General

to us for filing purposes, a copy of the May 22, 1961, memorandum is attached hereto for your information.

You will note that Colonel Edwards advised he personally contacted Robert Mahou during the Fall of 1960 for the purpose of using Mahou as a "cutout" in contacts with Sam Giancana in connection with CIA's clandestine efforts against Castro. Colonel Edwards stated that Giancana's activities were completely "backstopped" by Mahou, who would frequently report Giancana's actions and information to Edwards. No details or methods used by Mahou or Giancana in accomplishing their missions were reported to him, according to Edwards, as such involved "dirty business," of which Colonel Edwards could not afford to have knowledge. Accordingly, he said he had no prior knowledge of the above-mentioned wire tapping by Ballotti.

Further with respect to this matter, I was informed of the following on a highly confidential basis by former Attorney General Kennedy during a conference in my office on May 9, 1962:

He indicated that a few days prior thereto he had been advised by CIA that Robert A. Mahou had been hired by CIA to approach Sam Giancana with a proposition of paying \$150,000 to hire some gunmen to go into Cuba and kill Castro. He further stated CIA admitted having assisted Mahou in making the "bugging" installation in Las Vegas (referred to above) which uncovered this clandestine operation and for this reason CIA could not afford to have any action taken against Giancana or Mahou. Mr. Kennedy stated that upon learning CIA had not cleared its action in hiring Mahou and Giancana with the Department of Justice he issued orders that CIA should never again take such steps without first checking with the Department of Justice.

Mr. Kennedy further advised that because of this matter it would be very difficult to initiate any prosecution against Giancana, as Giancana could immediately bring out the fact the United States Government had approached him to arrange for the assassination of Castro. He stated the same was true concerning any action we might take against Mahou for any violation in which he might become involved.

On June 20, 1962, Mr. William Harvey, an official of CIA, advised that he had held a meeting with John Rosolli (referred to above as Mahou's link with Giancana) for the purpose of closing out the entire matter with which Rosolli had been involved. In this connection, Harvey stated that CIA had

The Attorney General

established contact with Roselli in "early 1961" with respect to a sensitive operation against Castro. Harvey said that for all intents and purposes the operation was discontinued and canceled after the ill-fated Bay of Pigs invasion in April, 1961, but Roselli had not been completely cut off, as he periodically indicated he was in a position to be of assistance.

It appears Roselli has since that time, nevertheless, used his prior connections with CIA to his best advantage. For example, in May, 1965, when contacted by Agents of this Bureau in connection with our current investigation of his activities he refused to talk and immediately flew to Washington, D. C., and consulted with Colonel Sheffield Edwards, who is now retired from CIA. Colonel Edwards in turn advised CIA, which told us. Mr. Howard J. Osborn, the present Director of Security, CIA, freely has admitted to us that Roselli has CIA in an unusually vulnerable position and that he would have no qualms about embarrassing CIA if it served his own interests. In furnishing this information, Mr. Osborn asked that it be held within this Bureau on a strictly need-to-know basis.

In light of the above information furnished us by CIA and former Attorney General Kennedy, it appears that data which came to our attention in October, 1960, possibly pertains to the captioned matter. At that time a source close to Giancana advised that during a conversation with several friends Giancana stated that Fidel Castro was "to be done away with very shortly." Giancana reportedly assured those present that Castro's assassination would occur in November, 1960, and that he had already met with the assassin-to-be on three occasions, the last meeting having taken place on a boat docked at the Fontainebleau Hotel, Miami Beach, Florida. Reportedly, Giancana claimed that everything had been perfected for the killing and the "assassin" had arranged with a girl, not further described, to drop a "pill" in Castro's drink or food.

Also of possible interest is a news article carried in the August 16, 1963, issue of the "Chicago Sun Times." This article carried the headline, "CIA Sought Giancana's Help For Cuba Spying," and it was reported therein that CIA agents had contacted Giancana in an effort to obtain Cuban intelligence after Castro came into power.

Enclosure

1 - The Deputy Attorney General. (Enclosure)

FEDERAL BUREAU OF INVESTIGATION
FREEDOM OF INFORMATION/PRIVACY ACTS SECTION

SUBJECT: FIDEL CASTRO

**FILE NUMBER: 105-212749 CROSS-
REFERENCES**

UNITED STATES GOVERNMENT

Memorandum

TO : DIRECTOR, FBI

DATE: 3/11/71

FROM: SAC, TAMPA (105-New) (RUC)

SUBJECT: ALLEGED PLOT TO INVADE HAITI
IS - HAITI
(OO: MIAMI)

Enclosed for the Bureau are five copies of an LHM. Two copies of this LHM are being designated for Miami.

The source mentioned in the enclosed LHM is

[REDACTED]

It should be pointed out that the enclosed LHM which contains [REDACTED] reveals information that the Tampa Division is not in a position to properly evaluate. It would appear that the Miami Division would be in a position to more properly assess the information, and so this is the reason the LHM is being directed to that office.

[REDACTED]

ENCLOSURE

- 2 - Bureau (Enc. 5) (RM)
 - 2 - Miami (Enc. 2) (RM)
 - 1 - Tampa
- WBG:rab
(5)

REC-73

EX 101

MCT
SAS

29772
N105-212749-1
15 MAR 15 1971

NAT. INT. SEC.



5010-108

NEW MEMO 105-

Buy U.S. Savings Bonds Regularly on the Payroll Savings Plan

6
6
TUTTA
AMH
3-24-71
3cc
105-6060/...

Pa

K

Wanda

47
4

TP 105-New

[REDACTED]

b7c
b7D

[REDACTED]

does not want to be compromised with respect to any investigation that is conducted as a result of the material in this letter.

Tampa is conducting no inquiry in this matter.



UNITED STATES DEPARTMENT OF JUSTICE

FEDERAL BUREAU OF INVESTIGATION

Tampa, Florida
March 11, 1971

In Reply, Please Refer to
File No.

ALLEGED PLOT TO INVADE HAITI

670 { On [REDACTED] a confidential source who has furnished reliable information in the past, advised that he had recently observed [REDACTED] and related newspaper clippings in the person of Donald Starr, a former reporter for the "St. Petersburg Times," a daily St. Petersburg, Florida, newspaper:

This document contains neither recommendations nor conclusions of the FBI. It is the property of the FBI and is loaned to your agency; it and its contents are not to be distributed outside your agency.

105-212749-1

ENCLOSURE

XXXXXX
XXXXXX
XXXXXX

FEDERAL BUREAU OF INVESTIGATION
FOIPA DELETED PAGE INFORMATION SHEET

8

Page(s) withheld entirely at this location in the file. One or more of the following statements, where indicated, explain this deletion.

- Deleted under exemption(s) b7C, b7D with no segregable material available for release to you.
- Information pertained only to a third party with no reference to you or the subject of your request.
- Information pertained only to a third party. Your name is listed in the title only.
- Document(s) originating with the following government agency(ies) _____, was/were forwarded to them for direct response to you.

_____ Page(s) referred for consultation to the following government agency(ies); _____ as the information originated with them. You will be advised of availability upon return of the material to the FBI.

_____ Page(s) withheld for the following reason(s):

For your information: _____

The following number is to be used for reference regarding these pages:
105-212749-1 (enclosure pages 2-9)

XXXXXX
XXXXXX
XXXXXX

XXXXXXXXXXXXXXXXXXXXX
X DELETED PAGE(S) X
X NO DUPLICATION FEE X
X FOR THIS PAGE X
XXXXXXXXXXXXXXXXXXXXX

Carson Sergeant Reveals Part in Cuban Gun-Runs

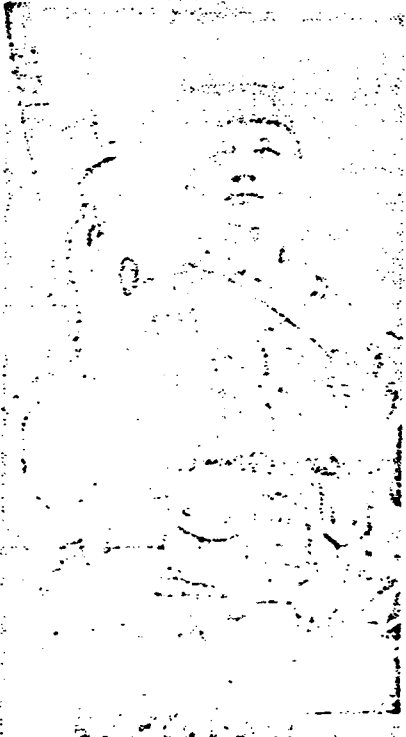
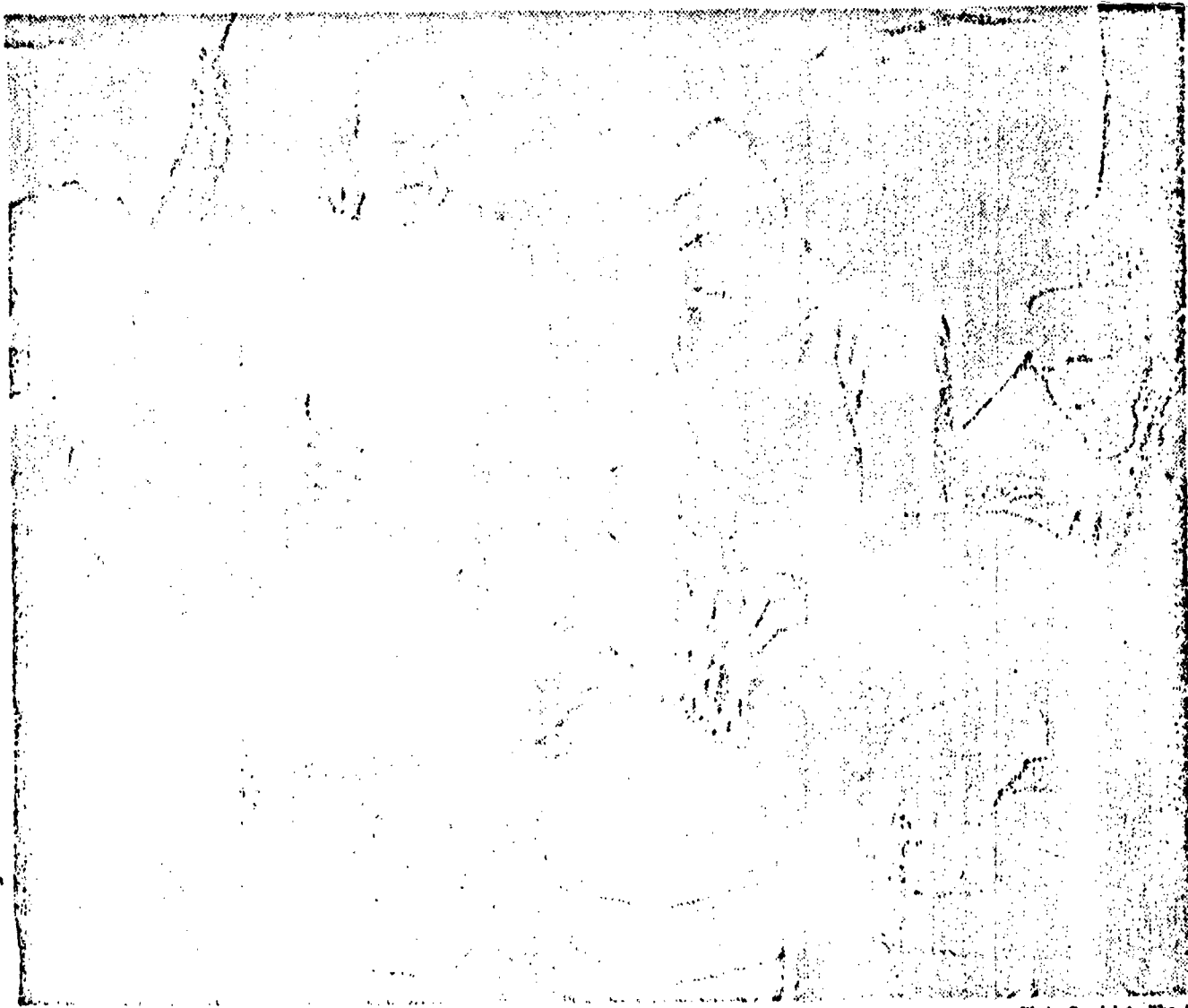

Photo Special to The SUN
REVOLUTIONARY — Sgt. Edward I. Arthur, now stationed at Ft. Carson, as he looked while training Cuban revolutionary fighters on a British island in the Caribbean in 1964. The weapon is a Swedish Fall submachinegun.



THE BOMB — Cuban revolutionaries working on the magnetic bomb they later used to blow up

the Russian ship "Baku" off the coast of Cuba March 27, 1963. Most of these men, members of

Photo Special to The SUN
"Commandos L," are now dead, killed in later actions on the Cuban mainland.

By MIKE WALES

Assistant City Editor
(c) 1971, The Colorado Springs SUN

A twice-wounded Vietnam veteran stationed at Ft. Carson has revealed he spent six years as an intelligence liaison officer with a Cuban revolutionary group in Florida; ran guns from California to Miami for them; assisted in the defection of a Haitian consul-general and trained Cuban rebels in the Florida swamps.

After a SUN reporter unearthed the facts in a two-month investigation, Sgt. Edward I. Arthur, an instructor at Ft. Carson's Recondo (ranger) school, admitted to The SUN in an exclusive interview that in 1964 he picked up guns in Orange County, Calif., that were donated to the Cuban rebel movement by ex-Minutemen. Arthur said he later delivered them to Cubans in Miami, who then smuggled some of them on to the Cuban mainland where they were used in hit and run raids against Castro's army.

"I hauled over two tons of automatic weapons, including a Swedish 20mm Lahli cannon and 100 rounds of armor-piercing ammo, right through the South during the worst days of the civil rights movement down there," he said.

The Ft. Carson soldier said he first went to Cuba in 1954 on a visit, then later returned in 1955 when Fidel Castro made his first landing attempt. "They were all killed but about 16," he said. He said everybody in Cuba was caught up in the spirit of the revolution, admitting, "I went down there originally to fight with Castro against Batista . . . I was like a lot of people in Florida who supported that slob (Castro) and got burned."

Later, in 1958, Arthur again returned to Cuba. That was the year Castro came out of the mountains with his bearded, ragged band and captured the interest of the world. He captured Ed Arthur's interest too, and it wasn't until 1960, the year the Cuban revolutionary took over, that Arthur became disenchanted with the bearded leader. "When he proclaimed himself a Communist that did it," Arthur said.

Since 1960 the Ft. Carson soldier has been an implacable foe of the bearded, cigar-smoking Castro, working closely with a Florida-based Cuban rebel group calling themselves "Commandos L" and staging hit and run raids into Cuba.

It was elements of this group that blasted the Russian ship "Baku" out of the water March 27, 1963, using a magnetic bomb built in Florida from parts smuggled across the country from half a dozen sources. Though Arthur may have played a large role in blowing up the Baku he isn't admitting it.

One thing is immediately evident in any conversation with the Ft. Carson instructor: He feels strongly about the Cubans' plight. He said he has long felt the Cuban problem is being handled badly and questions the wisdom of fighting a war against Communism (9,000) miles away (Vietnam) when the United States is standing under the threat of a Communist-controlled country, 90 miles from its southern shores.

"I was trying to tell people in 1963 that the Russians were building submarine pens in Cuba but no one would listen," he said, pointing out that now the U.S. government has belatedly recognized the possible danger in the pens and has publicly admitted they exist.

Recently, Newsweek published a story revealing the existence of the pens.

Arthur, whose contacts with the Florida-based Cuban rebels are as solid as they were in 1964, insists there are still Russian-made missile bases in Cuba and that they are manned by Russian technologists. "Some of the rebels who have penetrated the Cuban mainland have seen these bases," Arthur said.

He also revealed that at least two platoons of Cuban rebels recently departed Florida and are now operating near Matanza, inside Cuba.

The Ft. Carson soldier is an intensely patriotic man who feels deeply the threat to the U.S. inherent in Castro and his regime. He stated flatly that although he had once been offered a means of financing a full-scale invasion of the Cuban mainland he turned it down because "it would have embarrassed the United States and that is not my intention. I would rather arouse the public in this country to the danger down there than put the country into a position where it would have to become involved in spite of itself."

He sees the Cubans in America as an embattled people who were invited here by the government, then virtually abandoned. "All these people ever have wanted was a chance to fight their way back into their homeland," Arthur said.

(See Sergeant, Page 2)

13



TEST FIRING — Members of "Commandos L," a Cuban revolutionary group, test fire smuggled weapons on an island

Photo Special
in the Caribbean. The weapons are representative of several countries.

Sergeant Reveals Part in Cuban Gun-Running

Sergeant Reveals Part in Cuban Gun-Running

(Continued From Page 1)

In 1951 Arthur said he and his group thought they had found a way. Dr. Clemente Benoit, Haitian consul general to the Bahama Islands, suddenly defected to the United States, assisted by Commandos L and Ed Arthur, who acted as Benoit's aide, but was actually his bodyguard. "We wanted the narrow peninsula laying on the Windward Passage just 25 miles from the Cuban mainland and we saw Dr. Benoit as the possible key," Arthur said.

The Ft. Carson soldier explained the Benoit defection this way: "He (Benoit) defected from the government in Haiti and in doing so, wanted to enter the United States. My function in the beginning, was to fly to the Bahamas and protect the man's life from the Ton-Ton Macoutes (Haitian president Dr. Francois Duvalier's infamous squad). They had landed some people in the Bahamas and I was called in to get Benoit into the U.S. in one piece, which I did.

"After we arrived in the United States certain factions unknown to me, were setting up a little deal with Benoit to overthrow Duvalier so they could use Haiti to operate against Cuba. So it was Cubans and the Haitians working out a deal together . . . the Cuban exiles and the Haitian exiles — to overthrow both governments. We were convinced that the Kennedys and Johnson — the Kennedy administration — would do nothing against Fidel Castro. So the exiles took upon themselves . . . to get out of U.S. territory, which would eliminate any CIA interference or from any other agency. I discovered all this after I got Benoit back to the U.S. in 1953."

History has recorded the fact that the attempted invasion of Haiti by Haitian exiles failed, but Arthur is convinced there'll be another attempt. In a letter to Arthur from Dr. Benoit the Haitian writes: "This is to certify that the Parti Revolutionnaire Haitian in exile, which represents more than 3,000 Haitian refugees, has officially joined forces with Americans For Libertad (Commandos L) under the command of Eddie Arthur.

"Our main goal is to fight against tyranny, terrorism and dictatorship. "More than 500 members of the Haitian Revolutionary Parti are ready to go and fight Duvalier and it links with the Americans por Libertad." The letter was signed by Dr. Benoit Sept. 12, 1963, in the Bahamas.

Arthur has another interesting letter in his possession, this one from Gen. Claire Chennault, of Flying Tigers fame, in which the famous World War II general discusses the possibility of joining Arthur's group in an invasion of Cuba. In August of 1954, Arthur left Florida driving an Oldsmobile touring car. Arriving in Los Angeles, he traded the car for a 1957 Chevrolet, heavy-duty pickup truck then drove it to the San Fernando Valley north of Los Angeles where he picked up a 20MM cannon and 100 rounds of armor-piercing ammo. The heavy weapon, he said, was donated to the Cuban exile's cause by a group that had splintered away from Minute Man Robert Dopey's group because they were "too violent." The weapon was boxed in a crate and labeled "surveying equipment" and Arthur then drove the truck to Columbus, Ohio, where he stored it in a garage. "The whole operation was arranged by Commandos L," he said. It is at this point that Arthur's story becomes mysterious and he doesn't talk about what happened next. He left the United States and traveled to Czechoslovakia, arriving there in September. According to his passport he then traveled to France, Austria, East Germany, Yugoslavia, Holland and Belgium, returning to the U.S. in early October. When asked what he was doing in Europe he said simply, "Taking pictures behind the Iron Curtain."

After returning to the U.S., Arthur proceeded to St. Louis, Mo. where he met with ex-members of the Minutemen and picked up another load of weapons. Included were a number of automatic weapons such as a 50 cal. machinegun, a 30S cal. machinegun and a 30 cal. machinegun. Quite a number of M1 Army rifles and Colt .45s as well as a 9 mm. Browning Automatic rifle were include in this load. These were also boxed and labeled as "surveying equipment."

A receipt signed by Pedro Muina, civilian coordinator of Commandos L and Oscar C. de Tuya Jr., director, is still in existence and lists every weapon in his clandestine load.

Arthur left Columbus, Ohio, in November 1964 with his load of weapons, driving through most of the southern states on his way to Florida. In Mississippi he ran into a roadblock manned by 10 state troopers, who asked him what he was carrying. "I told them I had surveying equipment on the truck and was taking it to a construction company in Florida," Arthur said, adding ruefully, "This was during the Selma, Ala., race thing and I was thinking how funny it was that these troopers were out there on the highway trying to keep suspicious people away from Selma and here they let me pass right through with enough explosives in my truck to blow the town up."

He was stopped again just inside Florida and this time the troopers looked in the back of the truck but let him go on. The Ft. Carson soldier said he finally delivered his disguised load of armament to his contacts in Florida and was stopped by the U.S. Immigration authorities shortly after. "If they had been two hours earlier they would have had me cold," he said.

The most interesting thing about Ed Arthur's gun-run across the country was the fact that he was driving a truck with California plates, bound for Florida, and carrying an Ohio driver's license, and yet not one of the troopers who stopped him thought it was odd. A book, being written by Cleveland, Ohio, author Ulf Goebel, will, according to Arthur, be published within the next three months and will chronicle the Ft. Carson soldier's life and experiences in detail. In a telephone interview with Goebel, The SUN was told, "This book is going to come as a surprise to a lot of people in this country who think what happened, and has been happening, in Florida with the Cuban thing is strictly something the exiles are involved in. Quite a few Americans are involved in it too."

Today Ed Arthur lives quietly in a Colorado Springs suburb and trains men at the Ft. Carson Reconado School in the techniques of ranger warfare. There is probably no one at Ft. Carson with better qualifications. As he says: "I have been the route."

710

CIA Tried To Murder Castro

By JACK ANDERSON

(C) 1971 by Bell-McClure Syndicate

WASHINGTON — Locked in the darkest recesses of the Central Intelligence Agency is the story of six assassination attempts against Cuba's Fidel Castro.

For 10 years, only a few key people have known the terrible secret. They have sworn never to talk. Yet we have learned the details from sources whose credentials are beyond question.

The plot to knock off Castro began as part of the Bay of Pigs operation. The intent was to eliminate the Cuban Dictator before the motley invaders landed on the island. Their arrival was expected to touch off a general uprising, which the communist militia would have had more trouble putting down without the charismatic Castro to lead them.

After the first attempt failed, five more assassination teams were sent to Cuba. The last team reportedly made it to a rooftop within shooting distance of Castro before members were apprehended. This happened around the last of February or first of March, 1963.

Nine months later, President Kennedy was gunned down in Dallas by Lee Harvey Oswald, a fanatic who previously had agitated for Castro in New Orleans and had made a mysterious trip to the Cuban Embassy in Mexico City.

Among those privy to the CIA conspiracy, there is still a nagging suspicion — unsupported by the Warren Commission's findings — that

Castro became aware of the U.S. plot upon his life and somehow recruited Oswald to retaliate against President Kennedy.

☆☆☆☆

To set up the Castro assassination, the CIA enlisted Robert Maheu, a former FBI agent with shadowy contacts, who had handled other undercover assignments for the CIA out of his Washington public relations office. He later moved to Las Vegas to head up billionaire Howard Hughes's Nevada operations.

Maheu recruited John Roselli, a ruggedly handsome gambler with contacts in both the American and Cuban underworlds, to arrange the assassination. The dapper, hawk-faced Roselli, formerly married to movie actress June Lang, was a power in the movie industry until his conviction with racketeer Willie Bioff in a million-dollar Hollywood labor shakedown.

The CIA assigned two of its most trusted operatives, William Harvey and James "Big Jim" O'Connell, to the hush-hush murder mission. Using phony names, they accompanied Roselli on trips to Miami to line up the assassination teams.

The full story reads like the script of a James Bond movie, complete with secret trysts at glittering Miami Beach hotels and midnight powerboat dashes to secret landing spots on the Cuban coast. Once, Roselli's boat was shot out from under him.

For the first try, the CIA furnished Roselli with special poison capsules to slip into Castro's food. The poison was

(See Did Castro, Page 2)

Did Castro Get Oswald To Kill JFK in Revenge?

(Continued from Page 1)

supposed to take three days to act. By the time Castro died, his system would throw off all traces of the poison, so he would appear to be the victim of a natural if mysterious ailment.

Roselli arranged with a Cuban, related to one of Castro's chefs, to plant the deadly pellets in the dictator's food. On March 13, 1961, Roselli delivered the capsules to his contact at Miami Beach's glamorous Fontainebleau Hotel.

A couple weeks later, just about the right time for the plot to have been carried out, a report out of Havana said Castro was ill. But he recovered before the Bay of Pigs invasion on April 17, 1961.

The Cuban who had sneaked the poison into Havana was never seen again. The CIA, unsure whether the plotters had failed or the poison simply hadn't been strong enough, decided to try again with a more powerful dose. Roselli arranged for triple-strength capsules to be slipped into Castro's food several weeks after the Bay of Pigs. But once again, the plot failed and the conspirators disappeared.

Four more attempts were made on Castro's life, using Cuban assassination teams equipped with high-powered rifles, explosive and two-way radios. At intervals in the dark of night, Roselli personally delivered the teams in twin powerboats to the Cuban shores.

Once, a Cuban patrol boat sank Roselli's boat with a lucky shot but the occupants were quickly fished out of the murky water by the other boat. The assassination teams never got a shot at Castro, although the last group reached a rooftop within range. No doubt most of the infiltrators were picked up and tortured terribly.

Roselli, Harvey, O'Connell and company had taken precautions, however, to make sure not even the

Cuban recruits knew the CIA was behind the plot. Roselli posed as a representative of big oil interests which sought revenge against Castro expropriating their holdings in Cuba. The weapons and other equipment were of foreign make, mostly Belgian, to prevent any link to the U.S.

All the equipment, including the two powerboats, were purchased out of Roselli's own pocket. The CIA paid only the expenses of its two agents Harvey and O'Connell.

The principals in the CIA conspiracy, sworn to deep secrecy, refused to comment on the caper. We got an admission out of Maheu only that he had handled special jobs for the CIA, but he refused to discuss them. Roselli responded with a flat "no comment."

My associate Les Whitten located Harvey, who left the CIA about two years ago, in Indianapolis. Asked about Roselli, Harvey said he had a high regard for him. Whitten then questioned Harvey about Roselli's daring work.

"This is a long story," replied the former CIA man, "I don't think it ought to be printed." Thereafter, he refused to acknowledge even that he had been a CIA operative.

We got an admission from "Big Jim" O'Connell, who is still with the CIA, that he had met Roselli through Maheu. But when we asked about Roselli's CIA mission, O'Connell also clammed up.

Finally we spoke to John McCone, who headed the CIA at the time of the assassination attempts. He acknowledged the idea had been discussed inside the CIA but insisted it had been "rejected immediately." He vigorously denied that the CIA had ever participated in any plot on Castro's life. Asked whether the attempts could have been made without his knowledge, he replied: "It could not have happened."

We have complete confidence, however, in our sources.

* * * * *

Cuban Exile Group Involved in Ploy?

By MIKE WALES
Assistant City Editor

The Jack Anderson column elsewhere on this page poses some questions. The SUN, in its recent investigation of ex-Cuban revolutionary Edward I. Arthur, an instructor at the Recoado School at Ft. Carson, may have found the answers.

The Anderson column mentions a number of assassination team attempts on the life of Fidel Castro in the early 1960s. During its investigation of Arthur, The SUN discovered through a number of Florida contacts that a Cuban exile group, the International Brigade, furnished the manpower for these aborted assassination attempts.

And, according to Rick Townly, an investigative reporter for Channel 7 television in Miami, Arthur received an invitation to a meet in the home of a highly-placed member of the

Mafia in 1963. Arthur reportedly visited the home, a \$200,000 mansion belonging to Mafia don Sam Giancana, where a number of Cubans and Italians were gathered. According to a statement made by James Buchanan of the Pompano Beach Sun-Sentinel, shortly after the 1963 meet, Giancana had offered Arthur a large sum of money to arrange the assassination of "that man in Cuba."

Arthur told Buchanan he refused the offer and walked out. It is highly probable, according to Buchanan, that one of the men at the meeting was John Roselli, named in the Anderson column as the ringleader in the Castro assassination attempts.

According to Townly and at least one other Florida source, the go-between who handled the details set-

(See Cuban, Page 2)

Cuban Exile Group Part of Ploy?

(Continued From Page 1)

tiling up the several assassination attempts of Castro was a private detective who, at that time, was seen a number of times in the company of New Orleans crime boss Carlos Marcelo, and makes his headquarters in both Miami and New Orleans. Described as a "deadly man who carries a pearl-handled .38," the mysterious private eye was also on the scene when defecting Haitian counsel-general Clemente Beniot landed in Florida, escorted by Arthur, who was riding "shotgun" on the defector to protect him from Haitian Ton-Ton Macoutes (secret police), who, according to a statement made by Arthur at that time, were "attempting to do a job (murder)" on Beniot.

Arthur refused over the weekend to either comment on the Anderson column or answer further questions put by a SUN reporter.

Another figure who may have played a role in the assassination attempts is Frank Farini, who was active with the International Brigade at that time, a Florida source told The SUN.

Farini operated an import-export business in Havana in 1956, a business he abandoned to join Castro in the Escambrá.

Meanwhile Arthur had surfaced in Havana that same year and met soldier-of-fortune "Morgan (the only name he went by)" there. The two men left Havana and proceeded to Santa Lucia on the northwest end of the island, then wandered around Cuba for several weeks until Morgan suddenly left Arthur and went to join Castro.

Arthur's next appearance was in Florida where he was seen often around Miami Beach, Hollywood, and St. Petersburg. His fellow Americans, Farini and Morgan, were not so lucky. In 1959 Castro's brother, Raul, murdered Morgan when it was discovered he was part of a plot to assassinate the bearded leader. Morgan had reportedly become disenchanted with Castro after he announced for communism. Farini was tossed into prison by Castro and, in an operation that would be the envy of Agent 007, he

escaped on a plane and flew to freedom on the U.S. mainland. He reportedly lives in Miami, possibly biding his time until the next Cuban invasion.

And he may be sooner than anyone thinks. According to information from The SUN, an invasion scheduled for next year calls for an attack on Cuban exiles upon the Cuban mainland within the next two years.

The fact that Giancana and Marcello surfaced in the Florida cloak-and-suit games involving Castro's Cuban exiles is not surprising. Giancana has held an IOU from Castro since the days of his takeover and reportedly gave him a \$1 million bribe to allow them to continue to operate as usual in Havana, where they were family notables as "Luciano" and operated swank nightclubs and high-rolling gambling dens. In the wake of honoring the bribe, Castro ordered the arrest of several top officials, incarcerated them and then threw them out of the country, taking with them their gambling joints and clubs.

19*

1 - Mr. W. R. Wannall
1 - Mr. A. H. Solomon

SAC, Miami

3/24/71

Director, FBI

REC 105-212749-1
578
ALLEGED PLOT TO INVADE HAITI
IS - HAITI

RetPlet and LHM 3/11/71.

LHM not in form suitable for dissemination. First sentence of LHM is obviously incorrect. Pages two to nine consist of a barely readable Xerox copy of a rough draft letter which will require editing and copying before any dissemination will be made at Bureau. However, prior to Tampa's resubmitting LHM in acceptable form, attention is invited to the following:

Bureau files contain no information identifiable with [redacted] Edward I. Arthur is [redacted]

MAILED 21
MAR 23 1971
FBI

For the information of Tampa, Arthur is a soldier of fortune [redacted]

In the mid-1960s he was deeply involved with various anti-Castro and anti-Duvalier efforts and entertained ideas of military invasions of Haiti and Cuba to overthrow the existing governments. Arthur's motives appeared to be largely self-serving and it is clear he attempted to realize monetary gain from these efforts.

Miami should review the information in its files regarding [redacted] other individuals mentioned in referenced Tampa LHM and thereafter evaluate the content of the LHM based on Miami Office background in Cuban and Haitian matters and its knowledge of current developments in that area. Miami is then to recommend to the Bureau (by Tampa) regarding the desirability of Tampa's editing and resubmitting its information in a well-prepared and well-organized form suitable for dissemination.

[redacted] pa
95677 (Haitian Revolutionary Activities)

SEE NOTE - PAGE TWO

TELETYPE UNIT

UNRECORDED COPY FILED IN 105-212749-1

b7C
OS
b7C
OS

b7C

[Handwritten initials]

Letter to Miami
Re: Alleged Plot to Invade Haiti

NOTE:

b7D Tampa Office has submitted LHM obviously unsuitable for dissemination. Content is comprised of [REDACTED]

[REDACTED] several pages of newspaper clippings. Set forth is a rehash of past unsuccessful efforts to organize invasions of Cuba and Haiti by exiles and American soldiers of fortune. Included, however, is one statement that Cuban exiles in Florida are currently planning for invasion of Haiti, which is attributed to Edward Anthur, described in paragraph three. Bureau files contain no information to substantiate allegation and the reputation of the source mitigates against our taking any action.

FEDERAL BUREAU OF INVESTIGATION
FREEDOM OF INFORMATION/PRIVACY ACTS SECTION

SUBJECT: FIDEL CASTRO

FILE NUMBER: 137-7907 CROSS-REFERENCES

FEDERAL BUREAU OF INVESTIGATION
U. S. DEPARTMENT OF JUSTICE
COMMUNICATIONS SECTION

MAY 11 1966

TELETYPE

Mr. Tolson	_____
Mr. DeLoach	_____
Mr. Mohr	_____
Mr. Wick	_____
Mr. Casper	_____
Mr. Callahan	_____
Mr. Conrad	_____
Mr. Felt	_____
Mr. Gale	_____
Mr. Rosen	_____
Mr. Sullivan	_____
Mr. Tavel	_____
Mr. Trotter	_____
Tele. Room	_____
Miss Holmes	_____
Miss Gandy	_____

FBI LOS ANG.

1239 PM PDT URGENT 5-11-66 PLS

TO DIRECTOR (137-7907) AND (92-3267)

BOSTON (92-458), CHICAGO (92-399), MIAMI (92-517)

FROM LOS ANGELES (137-2602)

JOHN ROSSELLI, AKA. AR. IDENTICAL WITH [REDACTED]

b2
b7D

RE LOS ANGELES TELETYPES TO DIRECTOR FIVE FIVE
AND TEN LAST.

FOR INFORMATION RECEIVING OFFICES ROSSELLI
CONTACTED FIVE FIVE LAST PURSUANT APPROACH SET OUT LOS
ANGELES AIRTEL TO BUREAU FOUR FIFTEEN LAST. ROSSELLI
DID NOT APPEAR AT MEETING PLACE ON FIVE NINE, BUT HIS
ATTORNEY, JAMES CANTILON, CONTACTED LOS ANGELES OFFICE
THAT DATE AND WANTED INFORMATION REGARDING SUBJECT MATTER
ABOUT WHICH FBI WANTED INTERVIEW ROSSELLI. CANTILON
SAID HE WOULD DETERMINE IF ROSSELLI WOULD TALK TO AGENTS
ALONE AND WOULD THEN RECONTACT LOS ANGELES OFFICE.

REC 29 137-7907-9

ST-105

MAY 13 1966

FEDERAL BUREAU OF INVESTIGATION

END PAGE ONE

69 MAY 25 1966, 24

RECEIVED-6716

9-12

PAGE TWO

CANTILLON HAS NOT RECONTACTED LOS ANGELES OFFICE.

b7D A PCI ADVISED ROSSELLI WAS PICKED UP AT HIS APARTMENT ABOUT TWO FIFTY FIVE PM ON FIVE TEN LAST BY MAN DRIVING LATE MODEL MUSTANG. THIS CAR REGISTERED TO INDIVIDUAL BELIEVED TO HAVE PARKING CONCESSION FRIARS CLUB, BEVERLY HILLS, CALIFORNIA. ROSSELLI PUT LARGE LIGHT BROWN SUIT CASE AND TWO SWEATERS INTO MUSTANG. ROSSELLI 'S PONTIAC LEFT IN APARTMENT GARAGE. [REDACTED] HAS NO INFORMATION ROSSELLI LEFT LOS ANGELES VIA AIR. ROSSELLI 'S PRESENT WHEREABOUTS UNKNOWN.

LOS ANGELES OFFICE OF OPINION ROSSELLI DOES NOT INTEND TO COOPERATE AND PROBABLY LEFT APARTMENT IN ABOVE MANNER TO AVOID SURVEILLANCE.

b7D BOSTON, CHICAGO AND MIAMI IMMEDIATELY CONDUCT INTERVIEWS AND INVESTIGATION REQUESTED LOS ANGELES AIRTELS FOUR FIFTEEN AND TWENTY LAST. SPECIFICALLY ASK PERSONS INTERVIEWED FOR REASON ROSSELLI CHANGED NAME. INTERVIEWING AGENTS CAUTION NOT TO MENTION [REDACTED]

[REDACTED] STRESS RECORDS AS SOURCE BUREAU'S INFORMATION ROSSELLI'S TRUE IDENTITY? IMMEDIATELY ADVISE BUREAU AND LOS ANGELES RESULTS INVESTIGATION.

LOS ANGELES WILL INITIATE INTERVIEWS LOS ANGELES AREA OUTLINED IN ABOVE REFERENCED AIRTELS. BUREAU WILL
END PAGE TWO

PAGE THREE

BE KEPT ADVISED.

NEW YORK ADVISED AM.

END

WA...RCH

FBI WASH DC

BS...BCM

FBI BOSTON

CG...GAP

FBI CHICAGO

MM...SHR

FBI MIAMI

TU XØ

- Tolson _____
- Sullivan _____
- Mohr _____
- Bishop _____
- Brennan, C.D. _____
- Callahan _____
- Casper _____
- Conrad _____
- Dalbey _____
- Felt _____
- Gale _____
- Rosen _____
- Tavel _____
- Walters _____
- Soyars _____
- Tele. Room _____
- Holmes _____
- Gandy _____

The Washington Merry-Go-Round

Castro Stalker Worked for the CIA

By Jack Anderson

The mystery man whom the Central Intelligence Agency recruited to assassinate Cuba's Fidel Castro has been laid up in the sick ward of the Los Angeles County jail.

He is handsome, hawk-faced John Roselli, once a dashing figure around Hollywood and Las Vegas, now a gray, 66-year-old inmate with a respiratory ailment.

Confidential FBI files identify him as "a top Mafia figure" who watched over "the concealed interests in Las Vegas casinos of the Chicago underworld."

Roselli has admitted to friends that he was a rum runner during the Roaring Twenties. Operating along the East Coast, he learned how to evade Coast Guard cutters and police patrols.

His name later became linked with the biggest names in the Chicago and Los Angeles underworlds. He also developed contacts in the Cuban underworld before Castro took over the Havana gambling casinos.

He had the right background for a hush-hush mission that the CIA was planning in 1961. As part of the Bay of Pigs invasion, the CIA hoped to knock off Castro and leave Cuba leaderless.

Risks Neck

Roselli was recruited for the job by ROBERT MAHEU, a former FBI agent, who admitted to us that he had handled undercover assignments for the CIA. He refused, however, to discuss the details. This is the same Maheu, incidentally, who is now involved in a legal battle over phantom billionaire Howard Hughes' Nevada operations.

Roselli was so flattered over being asked to perform a secret mission for the U.S. government that he paid all his expenses out of his own pocket and risked his neck to land the assassination teams on the Cuban coast.

In James Bond fashion, he held whispered meetings in Miami Beach hotels with Cubans willing to make an attempt on Castro's life. Once, he called in Chicago racket boss Sam Giancana to line up a contact. The confidential files report that Giancana had "gambling interest and an interest in the shrimp business in Cuba." However, the Chicago gangster took no direct part in the assassination plot.

Roselli made midnight dashes to Cuba with his hired assassins in twin powerboats. Once a Cuban patrol ship turned its guns on his darkened boat, tore a hole in the bottom and sank the boat. Roselli was fished out of the water by the other boat, which escaped into the shadows.

In earlier columns, we reported how the CIA furnished Roselli with deadly poison capsules which he tried through a relative of Castro's chef to plant in the dictator's food. Later, marksmen armed with high-powered Belgian rifles attempted to infiltrate close enough to gun Castro down.

All told, six assassination attempts were made, the last in the spring of 1963. Throughout this period, Roselli worked under the direct supervision of two secret CIA agents, William Harvey and James (Big Jim) O'Connell.

Roselli's Reward

The FBI which got wind of the assassination plot, has tried to pump Roselli for information. But he was sworn to silence by the CIA, and up to this moment, he hasn't broken it.

REC-76

Handwritten notes:
for
W...

- The Washington Post Times Herald _____
- The Washington Daily News _____
- The Evening Star (Washington) _____
- The Sunday Star (Washington) _____
- Daily News (New York) _____
- Sunday News (New York) _____
- New York Post _____
- The New York Times _____
- The Daily World _____
- The New Leader _____
- The Wall Street Journal _____
- The National Observer _____
- People's World _____

Date FEB 23 1971

REC-76

124-7907-A-
NOT RECORDED
133 MAR 5 1971
D. W. (over)

57

Meanwhile, the Justice Department, as part of its crack-down on organized crime, tried to nail Roselli. The FBI discovered that his Chicago birth records had been forged, that his name was really Filippo Sacco and that he had come to this country from Italy as a child. He was convicted for failing to register as an alien.

He was also convicted for conspiracy to rig card games at Los Angeles' exclusive Friar's Club.

Of Roselli's two CIA associates, Harvey has now retired to Indianapolis and O'Connell

is still on the CIA payroll. Both admitted to us a friendship with Roselli but refused to discuss their CIA activities. Harvey said he had a "high regard" for Roselli and called the Friar's Club case a "bum rap." Said Harvey: "The Friar's Club indictment is phony. Roselli had no more to do with that than I had."

Roselli's lawyers are now trying to get clemency for their client, citing our stories about his secret CIA service.

Firearms Fiasco

Under pressure from the firearms lobby, the Treasury Department has failed to enforce a vital section of the 1968 federal firearms act.

The law was passed after the murders of Sen. Robert Kennedy and Dr. Martin Luther King. It authorizes the Treasury Secretary to require full reports of all firearms and ammunition sales.

For the two years that the law has been in force, the Treasury Department has ignored this key provision. The gun industry has complained it would be a bookkeeping nightmare.

The federal government, which would have to compile all the sales data, has also been reluctant to spend the \$100 million it would cost for computers and staff to maintain the firearms files.

FEDERAL BUREAU OF INVESTIGATION
FREEDOM OF INFORMATION/PRIVACY ACTS SECTION

SUBJECT: FIDEL CASTRO

FILE NUMBER: 92-3171 CROSS-REFERENCES

The Attorney General

July 14, 1961

REC-51

Director, FBI 92-3171-314

SAMUEL M. GIANCANA

Samuel M. Giancana, Chicago racketeer, and his current romantic interest, Phyllis McGuire of the well-known McGuire singing trio, were interviewed separately at O'Hare International Airport by Agents of our Chicago Office on July 12, 1961. Our Agents had been forearmed with a grand jury subpoena for Miss McGuire. However, in view of her apparent cooperative attitude, the subpoena was not served pending verification of the information she provided.

Miss McGuire advised she has known Giancana for the past two years. She did not know the source of his income but had been told by Giancana that he was a retired bookmaker. She admitted receiving approximately \$5,000 in gifts from Giancana. However, she claims a 1961 Cadillac she recently obtained was paid for by herself, although all arrangements for receipt of this automobile were handled by Giancana. She denied being married or contemplating marriage to Giancana.

Giancana was exceptionally belligerent and abusive during the interview by our Agents and frequently used obscene words in describing authorities who he believed were responsible for the investigation of him. He was extremely bitter regarding what he terms "persecution of the Italians" and said "he wasn't going to take this laying down," and "I am going to light a fire under you guys." Giancana also told interviewing Agents "now you can tell your superchief you talked to me and he can tell the super superchief all about it." When queried as to whom he was referring to by the term super superchief, he replied "the Kennedys, who else." Throughout the interview Giancana was extremely uncooperative and declined to furnish any information regarding his activities.

Following completion of the McGuire & Giancana interviews and upon meeting each other again, Giancana, directing a remark to Miss McGuire, said "I told them to go to hell, why didn't you so we could get out of here." Whereupon, Miss McGuire, commenting to our Agents, stated "I just want you to know that I am not like him, I am a lady."

NOTE: See CG teletypes to Director 7/12 and 7/13/61.

FJS:rap
(10)

- Tolson
- Belmont
- Mohr
- DeLoach
- Evans
- Malone
- Rosen
- Sullivan
- Tavel
- Trotter
- Tele. Room
- Ingram
- Gandy

MAIL ROOM TELETYPE UNIT

57 JUL 21 1961

ALL INFORMATION CONTAINED
HEREIN IS UNCLASSIFIED
DATE 3/11/81 BY SP4-*[signature]*

MAILED 2
JUL 14 1961
COMM-FBI

CIA info unclassified per
John E. Bacon 8/27/80

7070047 22300

RECEIVED
JUL 14 1961

[Handwritten signatures and initials]

The Attorney General

The consensus of the Agents participating in the above interview of Giancana was that Giancana was nervous, extremely shaken, appeared to exhibit psychotic tendencies and would explode with little or no provocation. u

The above is being furnished for your information. u

- 1 - Mr. Byron R. White
Deputy Attorney General
- 1 - Assistant Attorney General
Herbert J. Miller, Jr.

UNITED STATES DEPARTMENT OF JUSTICE
FEDERAL BUREAU OF INVESTIGATION

Copy to: U. S. Attorney, Los Angeles
ATTENTION: Assistant U. S. Attorney TIMOTHY M. THORNTON

Report of: [REDACTED] b7C
Date: 3/10/62

Office: Los Angeles,
California

Field Office File #: 92-113

Bureau File #: 92-3267

Title: JOHN ROSELLI

ALL INFORMATION CONTAINED
HEREIN IS UNCLASSIFIED

DATE 3/12/81 BY SP4-jun/

CIA info unclosed per
JOHN E. BACON 8/27/80

Character: ANTI-RACKETEERING

Synopsis:

ROSSELLI, FBI No. 3339986, claims birth at Chicago, Illinois, on 7/4/04. FBI Laboratory examination of signature on Report of Birth, filed in 1936, and on Affidavit of Birth upon which Report of Birth is based, reveals signatures to be forgeries. ROSSELLI married WINIFRED JUNE VLASEK (actress JUNE LANG) in 1940, was divorced in 1943, and has not remarried. In 1950 ROSSELLI testified before Kefauver Committee and stated he engaged in buying and selling liquor in Los Angeles during prohibition era; that he was acquainted with AL CAPONE and that he engaged in wire service for horse racing information in the late 1930's. He was convicted in Federal Court in New York City on 12/23/43 on charge of conspiracy to extort money from individuals in movie industry, sentenced to ten years imprisonment, and paroled in 1947. In 1957-1958, he was allegedly active in management of Tropicana Hotel, Las Vegas, Nevada, in an unofficial capacity. He obtained concessions from Tropicana Hotel but sold these in 1958 upon request of Nevada Gaming Control Board. He was officer in Monte Proser Productions, Inc., which produced floor shows at Tropicana Hotel, from 1957 until first part of 1959. Since 1959 has engaged in promoting and investing in various enterprises in Las Vegas area. He is currently engaged in producing motion picture of Las Vegas night life through Showcase Enterprises, Inc. He obtained contracts from all major hotels to shoot scenes in the casinos. Investigation indicates ROSSELLI may be handling various matters in Las Vegas for SAM GIANCANA, Chicago gambling figure. In December, 1961, he reported to

LA 92-113
HFD:nlb

GIANCANA concerning matters in Las Vegas. In latter part of 1961 he and GIANCANA involved in wire tap case in Las Vegas. He is in contact in Los Angeles with JUDITH E. CAMPBELL, who is friend of GIANCANA and who makes numerous telephone calls to GIANCANA's residence in Illinois. ROSSELLI has admitted he associates with highly controversial individuals who are friends, and said he would continue to associate with them. He allegedly stated he invests money for others in legitimate enterprises, but the money may be "illegitimate." He maintains apartments in Los Angeles and in Las Vegas and travels back and forth frequently.

-P-

LA 92-113
HFD:mib

Robert V. Maheu

*155 - Santa Anita
Brentwood, Calif.*

Information has also been set out in this report under the heading "Criminal Activities" reflecting that in the latter part of 1960, ROBERT A. MAHEU was requested by CIA to contact SAM GIANCANA regarding Cuban matters, and that MAHEU got in touch with GIANCANA through JOHN ROSSELLI; that thereafter, a wire tap was placed on the telephone of [REDACTED] at the Riviera Hotel in Las Vegas, Nevada, allegedly at the request of MAHEU, and according to MAHEU, to discover if there had been a leak of information through [REDACTED] a girl friend of SAM GIANCANA, who was then in [REDACTED] company with [REDACTED]. MAHEU advised that he had discussed some type of an installation with ROSSELLI prior to the time it was actually made.

Information is also set out in this report under the heading "Contacts and Associates" and specifically under the heading "JUDITH E. CAMPBELL" reflecting that CAMPBELL, a friend of GIANCANA, has been in frequent contact with GIANCANA's residence in Chicago via telephone, and she has also been in contact with JOHN ROSSELLI.

LA 92-113
HFD:djv

b7D
OS

POSSIBLE INVOLVEMENT IN WIRE TAPPING
AT RIVIERA HOTEL, LAS VEGAS, NEVADA.

On October 31, 1960, ARTHUR JAMES BALLETTI was arrested at the Riviera Hotel in Las Vegas, Nevada, at which time he admitted that he had received instructions from Investigations, Inc., Miami, Florida, to surveil and record telephone conversations of DAN ROWAN, who was then staying at the Riviera Hotel. BALLETTI stated that he had received instructions from ROBERT MAHEU to contact T. W. RICHARDSON at the New Frontier Hotel and RICHARDSON would pay him \$1,000 for the work which was being done by BALLETTI. Investigation revealed that an unknown individual using the name J. W. HARRISON, participated in the placing of the telephone surveillance in DAN ROWAN's room.

T. W. RICHARDSON, who is part owner of the New Frontier Hotel, upon interview denied knowing BALLETTI or paying any money to BALLETTI or anyone else in connection with this matter.

It is noted that at this time ROWAN was keeping company with PHYLLIS MC GUIRE of the MC GUIRE Sisters singing act and ROWAN later advised that he intended to marry PHYLLIS MC GUIRE.

LA 92-113
HFD:djv

670- PHYLIS MC GUIRE had reportedly been the girl friend of SAMUEL GIANCANA of Chicago. Information received during [REDACTED] indicates that GIANCANA is again keeping company with PHYLIS MC GUIRE.

EDWARD L. DUBOIS of Investigations, Inc. advised that in October, 1960, he received a telephone call from ROBERT MAHEU, a private investigator, Washington, D.C., requesting that DUBOIS send two men to Las Vegas on October 26, 1960, for physical surveillance work. Subsequently, according to DUBOIS, MAHEU told him only to send one man as he, MAHEU, was going to send one man. Thereafter, DUBOIS sent BALLETTI and the unknown individual who used the name J. W. HARRISON accompanied BALLETTI.

During the period from October 11 to October 29, 1960, ROBERT A. MAHEU and a J. A. ROLLINS were registered at the Kenilworth Hotel, Miami Beach, Florida, and ROLLINS accompanied MAHEU. MAHEU informed SAs of the FBI that J. A. ROLLINS was JOHN A. ROLLINS but refused to further identify him.

670- Investigation disclosed that while at the Kenilworth Hotel, ROLLINS was charged with two telephone calls to telephone number WH 3-1155 in Chicago, Illinois, which is the telephone number of [REDACTED] who has been identified in the ROSSELLI investigation as a close friend and associate of ROSSELLI. ROLLINS was also charged with a telephone call to telephone number DI 7-6228, Woodland Hills, California, which is the number of [REDACTED] who has also been identified as a close friend and associate of ROSSELLI.

ROLLINS was also charged with a telephone call to telephone number DU 2-6000 which is the telephone number of the Desert Inn Hotel, Las Vegas, Nevada, where ROSSELLI had received many telephone calls in the past.

JAMES FOLEY, an attorney in Las Vegas, Nevada, advised that in the latter part of October, 1960, he received a telephone call from JAMES P. CANTILLON of the law firm of Cantillon and Cantillon, Beverly Hills, California, requesting that FOLEY represent BALLETTI and arrange for his bond. CANTILLON personally guaranteed FOLEY's fee. It is noted

LA 92-113
HFD:djv

that JAMES P. CANTILLON is JOHN ROSSELLI's attorney and a close associate of ROSSELLI's.

Upon interview by SAs of the FBI, JAMES P. CANTILLON said that he first heard of the microphone incident when he received a call from a man in custody in Las Vegas whose name he did not recall. He said that the name BALLETTI was probably correct. He advised that he referred this man to THOMAS FOLEY an attorney in Las Vegas.

Further investigation revealed that Central Intelligence Agency (CIA) in connection with their operations concerning FIDEL CASTRO in Cuba contacted ROBERT MAHEU to act as "cutout" in contacts with SAM GIANCANA on the theory that GIANCANA through his gambling activities in Cuba under the Batista Government might still have sources and contacts in Cuba who could be of value to CIA. According to officials of CIA, this organization did not authorize the microphone surveillance on [REDACTED]

On May 25, 1961, MAHEU advised SAs of the FBI that the original contact with GIANCANA after MAHEU had been requested by CIA to make contact with GIANCANA was made by "JOHNNY" who he declined to further identify.

b7c On June 29, 1961, MAHEU advised SAs [REDACTED] and [REDACTED] that he would verify "JOHNNY's" identity if the Agents named the man. When JOHN ROSSELLI's name was furnished to MAHEU he admitted that ROSSELLI was the "JOHNNY" he referred to and that ROSSELLI was also identical to J. A. ROLLINS who registered with him at the Kenilworth Hotel in Miami Beach, Florida, in October, 1960.

ROBERT MAHEU was interviewed at 190 North Canon Drive, Beverly Hills, California, on July 13, 1961. MAHEU was informed of his right to an attorney and that he did not have to answer questions and that anything he did say could be used against him in a court of law.

MAHEU stated that in connection with the confidential assignment for CIA he had been in contact with SAMUEL GIANCANA and had received valuable assistance from GIANCANA, which, in turn, was furnished to CIA. MAHEU had reason to believe that

LA 92-113
HFD:djv

b7C { GIANCANA may have disclosed information regarding the project and, in view of the sensitive nature of the project, he, MAHEU, decided to determine whether or not GIANCANA had actually talked to unauthorized persons. He was aware that GIANCANA was very close in a romantic way with [REDACTED]. He said that if GIANCANA had disclosed this information regarding project to anyone, he would have disclosed it to [REDACTED]. He said that he was also aware that in the fall of 1960 the relations between [REDACTED] and GIANCANA were strained and that [REDACTED] was romantically involved with [REDACTED]. He considered it very vital to determine whether or not GIANCANA was reliable and decided to order an installation on [REDACTED] room in an effort to determine whether or not GIANCANA had disclosed any information regarding the project to [REDACTED].

MAHEU stated that this decision was his own and that GIANCANA had no knowledge that the installation was made. He said that he did discuss this with JOHN ROSSELLI, since he felt obligated to discuss it with ROSSELLI, as ROSSELLI had been instrumental in putting him in contact with GIANCANA. MAHEU denied that the installation was made at the request of ROSSELLI or GIANCANA or for the benefit of either ROSSELLI or GIANCANA. He said that he did discuss his decision with ROSSELLI some time prior to ordering the installation but does not recall the specific date or place where he discussed the matter with ROSSELLI. He pointed out that he does not recall whether or not this occurred during October, 1960, when they were both registered at the Kenilworth Hotel in Miami Beach, Florida. He pointed out that he had met with ROSSELLI on a number of occasions and, therefore, does not recall the specific occasion in which he discussed his decision with ROSSELLI. He does not recall what comment ROSSELLI made when informed of his decision.

b7C MAHEU said that he requested EDWARD L. DUBOIS, Jr., a Miami Beach private investigator, to institute a technical surveillance of [REDACTED] room at the Riviera Hotel in Las Vegas, Nevada. He said that he does not recall what his specific requests were regarding the

LA 92-113

HFD:djv

b7C
type of installation to be used, but had left this up to DUBOIS. He said that he was interested only in conversation within [redacted] room and had in mind the installation of a microphone and transmitter and not a telephone tap. He said, however, that he does not recall whether or not he specified not to make a telephone installation. He said that he does recall that he definitely did not request a physical surveillance of [redacted]

b7C
MAHEU stated that he does not know the identity of the unknown subject, also known as J. W. HARRISON. He said that he definitely did not contact DUBOIS and tell DUBOIS that he would send one of his men. He insisted that DUBOIS furnished both men to handle this assignment in Las Vegas and that DUBOIS had charged him for transportation and time for two men.

MAHEU repeated that he would take full responsibility for ordering the installation, that the installation was made for the reasons he had given above and in a previous interview, and definitely was not made at the request or for the benefit of JOHN ROSSELLI or SAMUEL GIANCANA.

JOHN ROSSELLI was contacted at Drucker's Hair-dressers for Men, 9740 Wilshire Boulevard, Beverly Hills, California. ROSSELLI was informed of his right to have an attorney and that he did not have to say anything and that anything he did say could be used against him in a court of law.

ROSSELLI admitted that he has known ROBERT MAHEU for approximately five years. When asked if he knew SAM GIANCANA, ROSSELLI stated, "Let's discuss the weather. I do not care to answer any more questions." ROSSELLI stated that he knew of nothing illegal that MAHEU had done, but for any additional information regarding his association with MAHEU, the Agents should talk with MAHEU himself.

b7C
ROSSELLI was telephonically contacted by SA [redacted] at his Los Angeles apartment, 1251 Crescent Heights Boulevard, Los Angeles, on July 19, 1961, in an effort to

LA 92-113
HFD:djv

arrange an interview. ROSSELLI advised that he did not care to discuss his association with MAHEU at any time with the FBI.

[REDACTED]

POSSIBLE EXTORTION IN CONNECTION
WITH SHOW "FLOWER DRUM SONG"
THUNDERBIRD HOTEL, LAS VEGAS, NEVADA

[REDACTED]

b7C
OS

FEDERAL BUREAU OF INVESTIGATION
FREEDOM OF INFORMATION/PRIVACY ACTS SECTION

SUBJECT: FIDEL CASTRO

FILE NUMBER: 92-18113

1 - Mr. Held
1 - Mr. Adams

August 6, 1976

Assistant Attorney General
Criminal Division

Director, FBI

REC-73
ST-100

92 - 18113

1 - Mr. Gallagher
1 - Mr. O'Connell
1 - Mr. Rhyne
1 - Mr. Mitchell
1 - Mr. Fehl
1 - Mr. Mintz
1 - Mr. Moore

JOHN ROSELLI
ANTI-RACKETEERING
MISSING PERSON

The following relates to the August 4, 1976, conferences held with you by Assistant Director Richard J. Gallagher, General Investigative Division of the FBI, and Mr. Gallagher's conference with William Lynch, Chief of the Organized Crime Section, Criminal Division, concerning the missing status of John Roselli.

David Walters, Attorney for John Roselli, Miami, Florida, advised the Miami FBI Office on August 2, 1976, that Mrs. Joseph Daigle, Plantation, Florida (Roselli's sister), had informed him that Roselli left the Daigle residence approximately 1:00 p.m., July 28, 1976, in Mrs. Daigle's automobile and has not been seen or heard from since that time. Roselli resided at the Daigle residence.

Walters also related that on July 30, 1976, Mrs. Daigle's automobile was located by her husband, Joseph Daigle, parked in a garage at the Miami International Airport. Walters said he was going to notify the Chief Counsel, Senate Select Committee on Intelligence Activities (SSCIA) that Roselli has been missing since July 28, 1976. He also advised Mrs. Daigle to file a Missing Persons Report with the Broward County, Florida, authorities.

On the afternoon of August 3, 1976, U. S. Senator Edward Baker, SSCIA, contacted the Director of the FBI to advise his interest in Roselli because of testimony therefore, Senator Baker felt the production of Justice violation in connection with disappearance.

- Assoc. Dir. _____
- Dep. AD Adm. _____
- Dep. AD Inv. _____
- Asst. Dir.:
- Admin. _____
- Comp. Syst. _____
- Ext. Affairs _____
- Files & Com. _____
- Gen. Inv. _____
- Ident. _____
- Inspection _____
- Intell. _____
- Laboratory _____
- Plan. & Eval. _____
- Spec. Inv. _____
- Training _____
- Off. of Cong. & Public Affairs _____
- Director's Sec'y _____

PGM:pmg (13)

MAILED 16
SEE NOTE PAGE TWO
AUG 06 1976
FBI

58 AUG 25 1976

MAIL ROOM TELETYPE UNIT

Assistant Attorney General
Criminal Division

Confidential
The Minority Staff Director, SSCIA, has advised Roselli testified before that committee on June 24, 1975, September 22, 1975, and April 23, 1976, in Executive Session. On the first two occasions Roselli's testimony regarded plots to assassinate Fidel Castro. On the last occasion Roselli testified pursuant to an investigation being conducted regarding the assassination of President John F. Kennedy. The SSCIA recommended that a subsequent SSCIA continue its investigation into the Castro assassination plots and the assassination plot of President Kennedy. ~~SSCIA has not issued subpoenas or made any agreements with any prospective witnesses to date.~~

Roselli's Attorneys, Thomas Wadden, Washington, D. C., and David Walters, Miami, Florida, and Joseph and Edith Daigle, brother-in-law and sister of Roselli, were interviewed, without success, for information regarding Roselli's disappearance. According to Joseph Daigle, Roselli normally used his wife's car. Attorney Walters suggested that he check the hospitals, morgues, and airports for any information regarding Roselli. Daigle also stated Roselli often said, in jest, if he was ever missing to check the airport parking lot. He said he located the car on July 30, 1976, at the Miami International Airport. He checked the car's interior and trunk and found nothing unusual except a grease mark on the left window, which could have been caused by an individual's head resting on the window. Daigle stated Roselli generally stayed close to his residence and could offer no reason for his disappearance.

No information has been developed that Roselli's disappearance is due to his testifying and no information has been developed that he was forcefully abducted. We are conducting no active investigation; however, are following closely with local authorities. Senator Baker is being so advised.

NOTE: See Rhyne to Gallagher memo dated 8/6/76 captioned, "John Roselli, Anti-Racketeering, Missing Person."

APPROVED:

Assoc. Dir. _____

Dep. AD Adm. _____

Dep. AD Inv. _____

Asst. Dir.:

Adm. Serv. _____

Ext. Affairs _____

Fin. & Pers. _____

Gen. Inv. _____

Ident. _____

Inspection _____

Incl. _____

Laboratory _____

Legal Coun. _____

Plan. & Eval. _____

Rec. Mgnt. _____

Spec. Inv. _____

Training _____

PLM

BM
John
John
John

UNITED STATES GOVERNMENT

Memorandum

TO : Mr. Adams
FROM : R. J. Gallagher
SUBJECT: JOHN ROSELLI
ANTI-RACKETEERING
MISSING PERSON

DATE: 8/4/76

- 1 - Mr. Held
- 1 - Mr. Adams
- 1 - Mr. Gallagher
- 1 - Mr. Rhyne
- 1 - Mr. Cooke
- 1 - Mr. Moore
- 1 - Mr. Fehl
- 1 - Mr. Mintz

- Assoc. Dir. _____
- Dep. AD Adm. _____
- Dep. AD Inv. _____
- Asst. Dir.:
- Adm. Serv. _____
- Ext. Affairs _____
- Fin. & Pers. _____
- Ident. _____
- Inspection _____
- Intell. _____
- Laboratory _____
- Legal Coun. _____
- Plan. & Eval. _____
- Rec. Mgnt. _____
- Spec. Inv. _____
- Training _____
- Telephone Rm. _____
- Director Sec'y _____

congressional information not subject to the FOIPA

PURPOSE:



ALL INFORMATION CONTAINED
HEREIN IS UNCLASSIFIED
DATE 3/9/87 BY SP4 Jm/Kaa

ACTION: Miami has been instructed to interview Joseph Daigle for complete details as to how he happened to be checking airports where the car used by Roselli was located, when he reported the disappearance to the local authorities and what he knows about Roselli and his contacts.

EX-113 REC-59

- APPROVED:
- | | | |
|--------------------|--------------------|---------------------|
| Assoc. Dir. _____ | Ext. Affairs _____ | Laboratory _____ |
| Dep. AD Adm. _____ | Fin. & Pers. _____ | Legal Coun. _____ |
| Dep. AD Inv. _____ | Gen. Inv. _____ | Plan. & Eval. _____ |
| Asst. Dir. _____ | Ident. _____ | Rec. Mgnt. _____ |
| Adm. Serv. _____ | Inspection _____ | Spec. Inv. _____ |
| | Intell. _____ | Training _____ |

DETAILS:

congressional information



and Roselli testified before the original Senate Select Committee on 6/24/75, 9/22/75, and 4/23/76. On the first two occasions he testified regarding plots to assassinate Fidel Castro. On the last occasion

[Handwritten signature]

CONTINUED - OVER



RJG:ige 309
(9)

Buy U.S. Savings Bonds Regularly on the Payroll Savings Plan

Mé morandum to Mr. Adams
Re: JOHN ROSELLI

he testified pursuant to an investigation being conducted regarding the assassination of President John F. Kennedy. The original Senate Select Committee chaired by Senator Frank Church recommended to the new Senate Select Committee it continue its investigation into the Castro assassination plots and into the assassination plots of President Kennedy.

[REDACTED] Roselli would be considered a critical witness into any investigation of these assassination plots. U

[REDACTED]

[REDACTED]

[REDACTED] SAC Stames, Washington Field Office, has advised that Agents have learned that Jack Anderson intends to run a column on the disappearance probably as early as August 5. [REDACTED]

Miami was first advised on August 2 by David Walters, an attorney who is representing Roselli in deportation appeals (he was ordered deported January 10, 1975), that Mrs. Edith Daigle advised him on July 30, 1976, that her brother had been missing since July 28. Walters said the sister had no

Congressional information

Memorandum to Mr. Adams
Re: JOHN ROSELLI

communication with him since that time and felt that he met with foul play. u

Attorney David Walters advised our Miami Office on 8/3/76 that he would advise Edith Daigle to file a missing persons report with local authorities. u

On August 3, Mrs. Daigle was interviewed but furnished no additional pertinent information. On the same day, Attorney David Walters' secretary advised a Miami Agent that Attorney Thomas Wadden requested that Attorney Walters do nothing in the Roselli matter since he (Wadden) was handling the matter directly from the top. u

On the afternoon of August 4, the above information was furnished to Assistant Attorney General Richard Thornburgh and to William Lynch, Chief of the Organized Crime Section, Criminal Division. Assistant Attorney General Thornburgh stated that there did not appear to be any violation of Federal law, that we had a missing persons case, and there would be no Obstruction of Justice. Mr. Lynch felt there would be no Obstruction of Justice unless there was some definite information to the effect that harm befell Roselli because of his testimony which in this case occurred many months ago. Mr. Thornburgh felt this case should be closely followed and that Joe Daigle be interviewed to find out when he advised the local authorities, why there was a delay, and how he happened to check airports and find the automobile. Mr. Thornburgh felt that this matter should be followed with local authorities but we should not at this time conduct a real active investigation. u

FEDERAL BUREAU OF INVESTIGATION
FREEDOM OF INFORMATION/PRIVACY ACTS SECTION

SUBJECT: FIDEL CASTRO

FILE NUMBER: 62-101325 CROSS-REFERENCES

UNITED STATES GOVERNMENT

Memorandum

Tolson	_____
DeLoach	_____
Mohr	_____
Casper	_____
Callahan	_____
Conrad	_____
Felt	_____
Gale	_____
Rosen	_____
Sullivan	_____
Tavel	_____
Trotter	_____
Tele. Room	_____
Holmes	_____
Gandy	_____

TO :

Mr. Wick

DECLASSIFIED BY SP-5 RJM/ML 8-27-80
 DATE: 3-29-67 11-12-80

FROM :

M. A. Jones

~~CONFIDENTIAL~~

SUBJECT: ROBERT AIME MAHEU

CLASS. & EXT. BY SP-5 [signature]
 REASON: [signature]
 DATE OF REVIEW: 3-29-87

The Director has requested that files be reviewed concerning captioned individual.

Maheu was born on October 30, 1917, at Waterville, Maine. He is a former Bureau Agent who entered on duty in 1940 and resigned in 1947. His services were entirely satisfactory. In 1952 and for a short time thereafter, Maheu was Director of Security and Compliance, Small Defense Plants Administration. Since at least the middle 1950's he has operated the Robert A. Maheu Associates, a private investigative and public relations firm which has offices at 900 17th Street, Northwest, Washington, D. This firm has had business dealings with a number of foreign officials and governments and as a result has frequently come to our attention. Maheu and his firm have frequently been reported as engaging in wiretapping activities in behalf of their clients.

b6
b7C

[REDACTED]
 we have had circumspect dealings with Maheu.
 [REDACTED]

In 1961 we conducted investigation into an allegation that Arthur James Balletti had placed a wiretap at Las Vegas, Nevada, on a comedian who was then reportedly engaged to Phyllis McGuire, a girl friend of top hoodlum Sam Giancana. The investigation determined that Maheu was also involved, and when interviewed he claimed that the wiretap was placed in behalf of Central Intelligence Agency (CIA) which was seeking intelligence information on Cuba through the hoodlum element, including Giancana. With regard to this activity, Maheu claimed he was placed in contact with Giancana through John Roselli, prominent Los Angeles hoodlum.

Subsequently, a representative of CIA admitted contacting Maheu in the Fall of 1960 for the purpose of using him as a "cutout" in contacts with Giancana who was being utilized by them in some "dirt"

- 1 - Mr. DeLoach
- 1 - Mr. Wick
- 1 - Mr. Callahan

XEROX
 APR 19 1967

- 1 - Mr. Gale
- 1 - Mr. Sullivan

~~CONFIDENTIAL~~

JHC:jma (9)

CONTINUED - OVER

M. A. Jones to Wick memo
RE: ROBERT AIME MAHEU

~~CONFIDENTIAL~~

business" directed at Cuban Premier Fidel Castro. When Federal prosecution of Maheu was contemplated with regard to his wiretapping activities at Las Vegas, CIA objected, claiming that it would expose a sensitive operation of theirs that would bring damaging embarrassment to the United States Government. At the time, the Director noted, "This is an outrage." (e) u

In May, 1962, former Attorney General Kennedy advised us that he was informed by CIA that they had hired Maheu to approach Giancana with a proposition of paying the latter \$150,000 to hire some gunmen to kill Castro. CIA admitted to Kennedy they assisted Maheu in making the "bugging" installation at Las Vegas (referred to above) and for this reason they could afford no action to be taken against either Maheu or Giancana. At the time, Kennedy issued orders that CIA should never again take such steps without first checking with the Department of Justice. It is noted that the above information relating to the association between CIA, Maheu and Giancana was furnished to the White House by letter dated March 21, 1967, under "Top Secret" classification, after information was received a few days earlier from attorney (and former Bureau Agent) Edward P. Morgan that he had clients (unnamed) who knew that Castro was aware of CIA's plot to assassinate him. According to Morgan, Castro responded by sending teams of assassins into the United States to kill former President Kennedy. Morgan, of course, suggested that these teams had assisted Oswald in the assassination of former President Kennedy. (e) u

Maheu has a long record of serving the interests of millionaire-industrialist Howard Hughes, who has been reported as one of his "angels." Maheu and other private investigators were retained by Hughes in 1947 to investigate former United States Senator Owen Brewster. In 1959, Maheu's investigative firm was reported to be keeping an eye on several of Hughes' girlfriends while assisting in the transfer of some of Hughes Industries operations from California to Arizona. In 1960, a New York City newspaper reported that Maheu and another former FBI Agent (Robert L. King) were representing the Hughes interests in Washington, D. C. Recently, information was received that Maheu is representing Hughes in the purchase of the Desert Inn Hotel at Las Vegas. u

RECOMMENDATION:

For information. u

~~CONFIDENTIAL~~

**FEDERAL BUREAU OF INVESTIGATION
FREEDOM OF INFORMATION/PRIVACY ACTS SECTION**

SUBJECT: FIDEL CASTRO

FILE NUMBER: 62-116391 CROSS-REFERENCES

UNITED STATES GOVERNMENT

Memorandum

TO : Mr. J. B. Adams

DATE: 4/16/75

FROM : W. R. Wannall

1 - Mr. W. R. Wannall

1 - Mr. L. F. Schwartz

1 - Mr. F. J. Cassidy

SUBJECT: COMMISSION ON CIA
ACTIVITIES WITHIN THE
UNITED STATES
(ROCKEFELLER COMMISSION)

~~CONFIDENTIAL~~

- Dep. Dir. _____
- Asst. Dir.:
- Adm. _____
- Comp. Syst. _____
- Ext. Affairs _____
- Files & Com. _____
- Gen. Inv. _____
- Ident. _____
- Inspection _____
- Intell. _____
- Laboratory _____
- Plan. & Eval. _____
- Spec. Inv. _____
- Training _____
- Telephone Rm. _____
- Director Sec'y _____

Handwritten signature/initials

By letter dated 3/25/75 to Mr. James A. Wilderotter, Associate Deputy Attorney General, Mr. James N. Roethe, staff attorney of captioned Commission, levied a number of requests for FBI documents to be supplied to the Commission.

One of the requests was for "any notes or interoffice memoranda pertaining to the two letters of Mr. Papich to Mr. Hoover dated March 2, 1970, and November 6, 1967."

With the Director's approval the two Papich letters mentioned above were furnished to the Rockefeller Commission on 3/21/75.

With regard to the Papich letter of 11/6/67, the copies which were furnished to the Commission contained notations made on the letter by Mr. Hoover. A search of Bureau files reveals two additional documents which resulted from the Papich letter of 11/6/67; namely, a memorandum from C. D. DeLoach to Mr. Tolson, 11/8/67, which reported the results of an interview of Papich by DeLoach on that date. During this interview, according to the DeLoach memorandum, he explained to Papich the reasons for the prohibitions and the persons responsible for such prohibitions against utilization of the investigative techniques mentioned in the Papich letter of 11/6/67.

The other communication which resulted from the Papich letter of 11/6 was a letter from Mr. Hoover to Mr. Papich dated 11/9/67 in which Mr. Hoover expressed his shock at the lack of understanding of key people concerning Departmental regulations as well as other influences beyond the Bureau's control which determine policy within the FBI.

62-116391

Enclosures - sent 4-21-75
FJC:aso (6)

AUG 28 1975

CONTINUED - OVER

14/11/75

SECRET MATERIAL ATTACHED

84 SEP 18 1975

~~CONFIDENTIAL~~

Handwritten initials/signature

ALL INFORMATION CONTAINED
HEREIN IS UNCLASSIFIED
EXCEPT WHERE SHOWN
OTHERWISE

CLASS. & EXT. BY SP4/...
REASON-FCIM II, 1-2.4.2 2.3
DATE OF REVIEW 4/16/95
FOIPA# 23,350

3/28/75

UNITED STATES GOVERNMENT

Memorandum

SECRET

Prior Release was made to Rockefeller Commission

TO : The Director

DATE: 3/13/70 3/16/81 ✓

FROM : SA Sam Papich

CLASS. & EXT. BY SP4 *[Signature]*
REASON-FCIM II, 1-2.4.2 23
DATE OF REVIEW 3/13/90

SUBJECT: RELATIONS WITH CIA

702px #22,330
ALL INFORMATION CONTAINED
HEREIN IS UNCLASSIFIED
EXCEPT WHERE SHOWN
OTHERWISE

CIA info on pg 21 & 22
only was declassified per
John E. Bacon 8/27/80

Mr. Tolson	
Mr. DeLoach	
Mr. Mohr	
Mr. Bishop	
Mr. Casper	
Mr. Callahan	
Mr. Conrad	
Mr. Felt	
Mr. Gale	
Mr. Rosen	
Mr. Sullivan	
Mr. Tavel	
Mr. Trotter	
Tele. Room	
Miss Holmes	
Miss Gandy	

Reference is made to my letters dated March 2 and March 5, 1970. In my letter of March 5, 1970, I stated "it is important to emphasize that the Bureau can also produce an extensive list of justified grievances." It is my understanding that the Director desired that this list be identified. Enclosed herewith is a list of approximately 75 items.

This list should not be considered absolutely complete. Preparation was predicated on my personal recollection and a review of Bureau records. To make this list more complete and specifically accurate would necessitate the review of thousands of files. The enclosed list can be supported by Bureau records. What CIA records reflect on the same items is unknown. This also must be kept in mind in connection with our evaluation of the alleged CIA grievances which I previously listed.

I realize that it is presumptuous on my part, but if the Director feels that our Bureau work can benefit by a personal discussion between the Director and myself, I am available until April 3, 1970. I plan to leave the area immediately thereafter for an extended period.

ACTION:

For information.

Enclosure

- 1 - Mr. DeLoach
- 1 - Mr. Sullivan
- 1 - Mr. Papich

SJP: ~~_____~~
(4)

REC- 67

62-116391-41

10 APR 1 1970

WST 102

ENCLOSURE

Classified by 12
Exempt from GDS, Category 2+3
Date of Declassification Indefinite

61-11-75

SECRET

On February 7, 1962, Colonel Sheffield Edwards, Director of Security, CIA, informed the Liaison Agent that CIA was preparing a report containing extremely sensitive information. He stated that this information came from a sensitive source and he was not certain as to how it should be handled. As a result of a discussion with Edwards on February 26, 1962, [REDACTED]

56
b7C
per
CIA

Edwards explained that he had been reluctant to identify this source at an earlier date because he feared that prosecution could have been jeopardized and, furthermore, he did not want his Agency embarrassed in the event the Bureau objected to CIA maintaining a capability such as technical surveillances. It was made emphatically clear to Edwards that it was absolutely necessary that we be provided with all the details and, furthermore, that CIA, at the outset, should have apprised us of the existence of the coverage. The Director made the notation, "I only wish we would eventually realize CIA can never be depended upon to deal forthrightly with us. Certainly my skepticism isn't based on prejudice nor suspicion, but on specific instances of all too many in number. Yet, there exists virifal belief that the 'leopard has changed his spots.' H." (Memorandum Brennan to Sullivan February 27, 1962, [REDACTED]) X (u)

56. [REDACTED]

In February, 1962, the Liaison Agent was requested to discuss with CIA a case which, in our opinion, clearly indicated CIA had failed to keep us appropriately informed of developments. The Bureau's original interest was initiated in Miami as a result of a discussion with CIA personnel in that city. Attempts to get CIA replies via correspondence were negative. On February 13, 1962, the Liaison Agent discussed the matter with CIA and received a reply which did not adequately satisfy the Bureau's request. (Memorandum Donahoe to Sullivan, February 27, 1962, and Brennan to Sullivan, March 2, 1962; Bureau file [REDACTED]) X (u)

57. CIA WIRE TAPPING IN THE UNITED STATES

Sometime prior to the Bay of Pigs fiasco, CIA had become involved in a weird plan designed to bring about the assassination of Fidel Castro. One of the principal ingredients of this plan was to be the utilization of U.S. hoodlums. CIA established contact with Robert Mahcu, former Bureau Agent, who served as the intermediary in dealings with the notorious hoodlum, Sam Giancana. X (u)

The entire operation fell apart when we developed information indicating that Mahou was behind a wire tapping operation in Nevada. Potentially, there were elements for possible violation of unauthorized publication or use of communications. However, prosecution was out of the question because of the tainted involvement of CIA. (Arthur James Balletti, "Unauthorized Publication or Use of Communications" and memorandum from the Director to Mr. Tolson, dated May 10, 1952) (u)

58. [REDACTED]

[REDACTED]

59. [REDACTED]

[REDACTED]

60. [REDACTED]

[REDACTED]

The entire operation fell apart when we developed information indicating that Mahou was behind a wire tapping operation in Nevada. Potentially, there were elements for possible violation of unauthorized publication or use of communications. However, prosecution was out of the question because of the tainted involvement of CIA. (Arthur James Balletti, "Unauthorized Publication or Use of Communications" and memorandum from the Director to Mr. Tolson, dated May 10, 1952) (u)

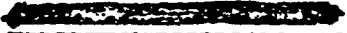
58. 

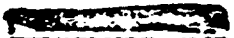

59. 

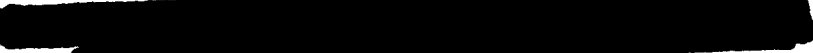

60. 

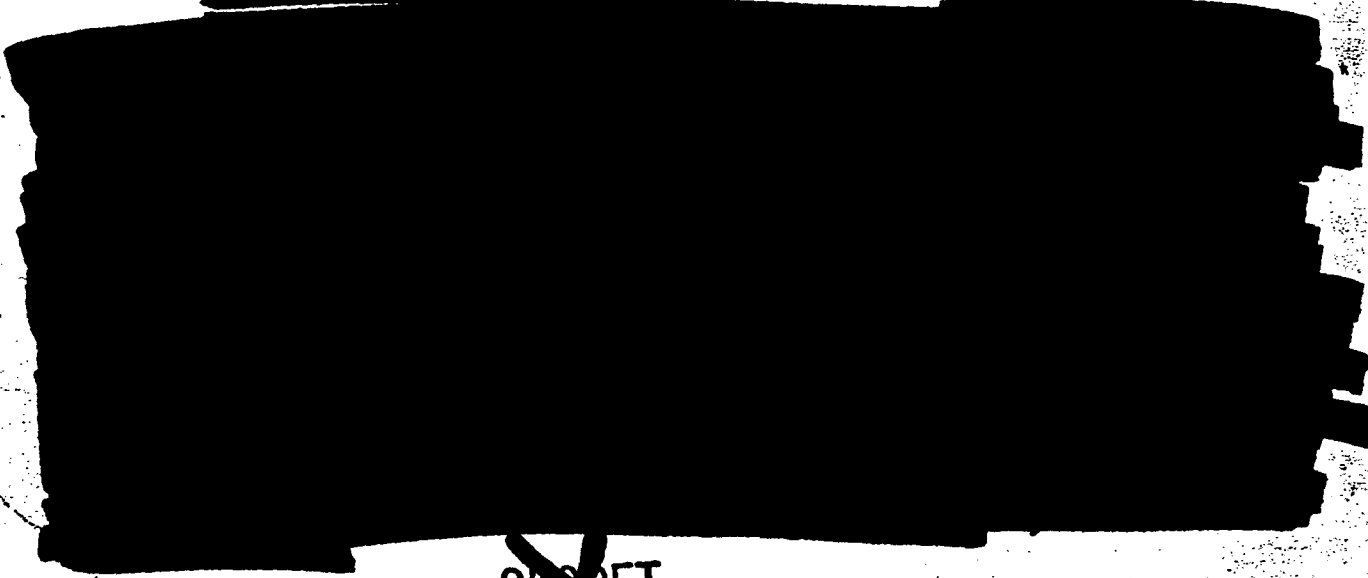

UNITED STATES GOVERNMENT

Memorandum

- Assoc. Dir. _____
- Dep. AD-Adm. _____
- Dep. AD-Inv. _____
- Asst. Dir.:
- Admin. _____
- Comp. Syst. _____
- Ext. Affairs _____
- Files & Com. _____
- Gen. Inv. _____
- Ident. _____
- Inspection _____
- Intell. _____
- Laboratory _____
- Plan. & Eval. _____
- Spec. Inv. _____
- Training _____
- Legal Coun. _____
- Telephone Rm. _____
- Director Sec'y _____

- 1 - Mr. J. B. Adams
- 1 - Mr. J. A. Mintz

DATE: 4/21/75

- 1 - Mr. W. R. Wannall
- 1 - Mr. F. J. Cassidy

TO : Mr. J. B. Adams

FROM : W. R. Wannall

SUBJECT: COMMISSION ON CIA ACTIVITIES
WITHIN THE UNITED STATES
(ROCKEFELLER COMMISSION)

My memorandum to you dated 4/8/75 (attached) advised of a request by Mr. James N. Roethe, staff attorney of captioned Commission, for "any documents in possession of the Bureau, including interoffice memoranda, showing a connection between CIA and known or suspected Mafia personalities specifically for, but not limited to, the period 1958 through 1965."

Our files revealed information pertaining to a connection between CIA and hoodlums John Roselli and Sam Giancana. All pertinent information is contained in the following documents: 1) memorandum W. R. Wannall to W. C. Sullivan, dated 3/6/67, captioned "Central Intelligence Agency's Intentions to Send Hoodlums to Cuba to Assassinate Castro"; 2) memorandum from the Director, FBI, to the Attorney General, dated 3/6/67, captioned as Item 1; 3) LHM dated 5/22/61, captioned "Arthur James Balletti, et al," which contained results of an interview with Colonel Sheffield Edwards, who in 1961 was Director of Security, CIA; and, 4) two memoranda from the Director of Security, CIA, dated 5/18/66 and 5/27/66, reporting additional meetings between CIA personnel and Roselli.

Referenced memorandum recommended that the above-mentioned documents be reviewed by the Special Investigative Division (SID) and if that Division interposed no objection the Intelligence Division (INTD) through liaison would obtain CIA clearance to furnish the information which originated with that Agency to the Commission. INTD would thereafter prepare cover communication necessary to transmit the documents to Mr. Roethe through the Department. This recommendation was approved. SID reviewed the attached documents and interposed no objection to the documents being furnished to the Commission.

APR 25 1975

On 4/9/75 a copy of the 5/22/61 LHM captioned "Arthur James Balletti, et al," which contained the results of our interview of Colonel Sheffield Edwards, then Director of Security, CIA; a memorandum from

Enclosures - sent 4-22-75
62-116391 342
FJC:aso (5)

CONTINUED - OVER

84 MAY 1 1975

TOP SECRET MATERIAL ATTACHED

ALL INFORMATION CONTAINED
HEREIN IS UNCLASSIFIED
DATE 3/9/81 BY SP4 Jem/Kao
#CIA Info unclassified
Per John E. Bacon 8/27/80

ENCLOSURE

AC

Memorandum to Mr. J. B. Adams
Re: Commission on CIA Activities
Within the United States
(Rockefeller Commission)
62-116391

C. D. Brennan to W. C. Sullivan, dated 6/21/63, captioned "John Roselli," which contained the results of an interview of William Harvey, an official of CIA, as set forth in the 3/6/67 memorandum to the Attorney General which we propose to furnish the Commission; and the memoranda from the Director, CIA, dated 5/18/66 and 5/27/66 were furnished to CIA for the purpose of obtaining their concurrence in furnishing the information contained in these documents to the Commission. The above comprises all of the information which originated with CIA contained in the documents we propose to furnish to the Commission. On 4/16/75 [REDACTED]

b3
per
CIA

[REDACTED] advised Liaison Supervisor L. F. Schwartz that CIA interposed no objection to our furnishing their memoranda of 5/18/66 and 5/27/66 to the Commission along with the results of our interview of Colonel Sheffield Edwards and Mr. Harvey.

No sensitive sources are involved and the Bureau communications pertaining to this matter revealed that we acted promptly on receipt of information concerning CIA's involvement with the hoodlums in notifying the Attorney General. In view of this it is felt these documents should be furnished to the Commission for incorporation in the Commission's files.

RECOMMENDATION:

If you agree, the attached letter to the Deputy Attorney General enclosing a memorandum for the Commission with the documents mentioned above be sent.

FIC

WAD
d/60

JBA
PCW

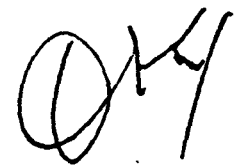

UNITED STATES GOVERNMENT ROUTE IN ENVELOPE

Memorandum

TO : W. C. Sullivan

DATE: March 6, 1967

FROM : W. R. Wannall

~~TOP SECRET~~

- 1 - [redacted]
- 1 - [redacted]
- 1 - [redacted]
- 1 - [redacted]
- 1 - [redacted]

SUBJECT: CENTRAL INTELLIGENCE AGENCY'S INTENTIONS TO SEND HOODLUMS TO CUBA TO ASSASSINATE CASTRO

DECLASSIFIED BY SP4-jm/koa *CIA Info declassified per John E. Bacon 8/2/80 ON 3/9/81 TO FOIA # 22,330

Classified by [redacted] 6040
10/1/87
10/1/88

In accordance with instructions, attached letter has been prepared for Attorney General setting forth all data in our files concerning captioned matter. Briefly, information being furnished is as follows: U

Matter first came to our attention in Spring of 1961 in connection with our investigation of violation of Unauthorized Publication or Use of Communications Statute on the part of Arthur James Balletti, arrested in Las Vegas, Nevada, by local authorities on wire tapping charge. Wire tap involved was on telephone of Dan Rowan, member of Rowan and Martin comedy team. Rowan at the time reportedly was engaged to Phyllis McGuire, girl friend of top hoodlum Sam Giancana and member of McGuire Sisters singing trio. U

Through our investigation we determined involvement of Robert A. Maheu, private detective, who stated coverage on Rowan instituted in behalf of Central Intelligence Agency (CIA) efforts to obtain Cuban intelligence data through hoodlum element, including Sam Giancana. Maheu was in contact with Giancana through services of John Roselli, another hoodlum, and Maheu authorized wiring of Rowan's room.

We checked matter with CIA on 5/3/61 and learned CIA was utilizing Maheu as intermediary with Sam Giancana relative to CIA's "dirty business" anti-Castro activities. CIA insisted it did not give Maheu any instructions relative to use of technical installations. By letter 5/22/61 we furnished former Attorney General Kennedy a memorandum containing a rundown on CIA's involvement in this. The originals of the letter and memorandum were returned to us for filing purposes. A copy of that memorandum is being attached to instant letter being sent to Attorney General. U

On 5/9/62 Kennedy discussed with the Director a number of matters, including admission by CIA that Robert Maheu had been

Enclosure
[redacted] 2

62-116391-42 TOP SECRET
ENCLOSURE

Memorandum for Mr. Sullivan
Re: CENTRAL INTELLIGENCE AGENCY'S
INTENTIONS TO SEND HOODLUMS TO
CUBA TO ASSASSINATE CASTRO

hired by that Agency to approach Sam Giancana to have Castro assassinated at a cost of \$150,000. Kennedy stated he had issued orders that CIA should never undertake such steps again without first checking with Department of Justice and stated because of this matter it would be difficult to prosecute Giancana or Maheu then or in the future.

We learned on 6/20/63 from CIA that its contacts with John Roselli (Maheu's link with Giancana) had continued up until that time, when they were reportedly cut off.

It appears Roselli is using his prior connections with CIA to his best advantage. In May, 1966, when Bureau Agents endeavored to interview him he immediately flew to Washington and informed his former CIA intermediary. The current Director of Security, CIA, has advised through liaison channels that Roselli has CIA in an unusually vulnerable position and Roselli would have no qualms about embarrassing CIA to serve his own interests. In furnishing this information we were asked that it be held within this Bureau on a strictly need-to-know basis. We have, however, included it in the attached proposed letter to the Attorney General noting this CIA specific restriction. ~~XS~~(u)

We have two other references in our files to the over-all above information which we have included in the letter. One relates to a statement by Giancana in October, 1960, that he had met with an individual who was to assassinate Castro in November, 1960. The other is an article in the 8/16/63 issue of the "Chicago Sun Times" reporting that CIA agents had contacted Giancana to obtain Cuban intelligence.

ACTION:

~~TOP SECRET~~

If approved, attached letter will be sent to the Attorney General, with a copy for the Deputy Attorney General.

The Attorney General
asked for this information
on Friday, 2/3/67.
✓

ROUTE IN ENVELOPE

- 1 - [REDACTED]
- 1 - [REDACTED]
- 1 - [REDACTED]
- 1 - [REDACTED]

March 6, 1967

The Attorney General
 DECLASSIFIED BY SP4 Spm/kca
 ON 3/9/81 707044 273330

Director, FBI
 *CIA Info Declassified per
 John E. Bacon 8/27/80

CENTRAL INTELLIGENCE AGENCY'S
 INTENTIONS TO SEND HOODLUMS TO
 CUBA TO ASSASSINATE CASTRO

Classified by 6049
 Exempt from automatic
 downgrading and
 declassification
12/21/77
8/2/80

Our files contain the following information concerning the captioned matter, much of which has been furnished by the Central Intelligence Agency (CIA) on a strictly highly confidential "need-to-know" basis. In view of this, it is requested that it be handled on a most restrictive basis. (u)

This matter first came to our attention in the Spring of 1961 in connection with our investigation of a violation of the Unauthorized Publication or Use of Communications Statute on the part of Arthur James Balletti, who had been arrested by local authorities in Las Vegas, Nevada, on a local wire tapping charge. Balletti and another unidentified individual in October, 1960, had reportedly placed a wire tap on the telephone of Dan Rowan, a member of the comedy team of Rowan and Martin. Rowan at the time reportedly was engaged to Phyllis McGuire of the well-known McGuire Sisters singing trio who was also known to be a girl friend of Sam Giancana, a top hoodlum.

During the course of the Balletti investigation it was ascertained that Robert A. Maheu, a private detective, was involved. Maheu during interview claimed he ordered coverage of Rowan in behalf of CIA's efforts to obtain intelligence information in Cuba through the hoodlum element, including Sam Giancana, which had interests there. Maheu said he was put in contact with Giancana in connection with these intelligence activities through John Roselli, a Los Angeles hoodlum. Maheu stated also that he authorized the wiretap of Robert Maheu and had discussed the matter with Roselli.

The essence of the above was furnished to former Attorney General Robert F. Kennedy by letter dated May 22, 1961 which enclosed a memorandum of the same date containing data made available on May 3, 1961, by Colonel Sheffield Edwards, who at that time was Director of Security at CIA, regarding his utilization of Maheu in connection with anti-Castro activities. Since our files show that Mr. Kennedy returned the original of our letter and its enclosed memorandum dated May 22, 1961,

62-11636-47
 TOP SECRET GROUP 1
 ENCLOSURE Excluded from automatic
 downgrading and
 declassification

The Attorney General

to us for filing purposes, a copy of the May 22, 1961, memorandum is attached hereto for your information. (u)

You will note that Colonel Edwards advised he personally contacted Robert Mahou during the Fall of 1960 for the purpose of using Mahou as a "cutout" in contacts with Sam Giancana in connection with CIA's clandestine efforts against Castro. Colonel Edwards stated that Giancana's activities were completely "backstopped" by Mahou, who would frequently report Giancana's actions and information to Edwards. No details or methods used by Mahou or Giancana in accomplishing their missions were reported to him, according to Edwards, as such involved "dirty business," of which Colonel Edwards could not afford to have knowledge. Accordingly, he said he had no prior knowledge of the above-mentioned wire tapping by Balotti. (u)

Further with respect to this matter, I was informed of the following on a highly confidential basis by former Attorney General Kennedy during a conference in my office on May 9, 1962:

He indicated that a few days prior thereto he had been advised by CIA that Robert A. Mahou had been hired by CIA to approach Sam Giancana with a proposition of paying \$150,000 to hire some gunmen to go into Cuba and kill Castro. He further stated CIA admitted having assisted Mahou in making the "bugging" installation in Las Vegas (referred to above) which uncovered this clandestine operation and for this reason CIA could not afford to have any action taken against Giancana or Mahou. Mr. Kennedy stated that upon learning CIA had not cleared its action in hiring Mahou and Giancana with the Department of Justice he issued orders that CIA should never again take such steps without first checking with the Department of Justice.

Mr. Kennedy further advised that because of this matter it would be very difficult to initiate any prosecution against Giancana, as Giancana could immediately bring out the fact the United States Government had approached him to arrange for the assassination of Castro. He stated the same was true concerning any action we might take against Mahou for any violation in which he might become involved.

On June 20, 1962, Mr. William Harvey, an official of CIA, advised that he had held a meeting with John Roselli (referred to above as Mahou's link with Giancana) for the purpose of closing out the entire matter with which Roselli had been involved. In this connection, Harvey stated that CIA had

The Attorney General

established contact with Roselli in "early 1961" with respect to a sensitive operation against Castro. Harvey said that for all intents and purposes the operation was discontinued and canceled after the ill-fated Bay of Pigs invasion in April, 1961, but Roselli had not been completely cut off, as he periodically indicated he was in a position to be of assistance.

It appears Roselli has since that time, nevertheless, used his prior connections with CIA to his best advantage. For example, in May, 1960, when contacted by Agents of this Bureau in connection with our current investigation of his activities he refused to talk and immediately flew to Washington, D. C., and consulted with Colonel Sheffield Edwards, who is now retired from CIA. Colonel Edwards in turn advised CIA, which told us. Mr. Howard J. Osborn, the present Director of Security, CIA, freely has admitted to us that Roselli has CIA in an unusually vulnerable position and that he would have no qualms about embarrassing CIA if it served his own interests. In furnishing this information, Mr. Osborn asked that it be held within this Bureau on a strictly need-to-know basis. *JS(u)*

In light of the above information furnished us by CIA and former Attorney General Kennedy, it appears that data which came to our attention in October, 1960, possibly pertains to the captioned matter. At that time a source close to Giancana advised that during a conversation with several friends Giancana stated that Fidel Castro was "to be done away with very shortly." Giancana reportedly assured those present that Castro's assassination would occur in November, 1960, and that he had already met with the assassin-to-be on three occasions, the last meeting having taken place on a boat docked at the Fontainebleau Hotel, Miami Beach, Florida. Reportedly, Giancana claimed that everything had been perfected for the killing and the "assassin" had arranged with a girl, not further described, to drop a "pill" in Castro's drink or food.

Also of possible interest is a news article carried in the August 16, 1963, issue of the "Chicago Sun Times." This article carried the headline, "CIA Sought Giancana's Help For Cuba Spying," and it was reported therein that CIA agents had contacted Giancana in an effort to obtain Cuban intelligence after Castro came into power. *u*

Enclosure

1 - The Deputy Attorney General (Enclosure)



UNITED STATES DEPARTMENT OF JUSTICE
FEDERAL BUREAU OF INVESTIGATION

WASHINGTON 25, D. C.

May 22, 1961

In Reply, Please Refer to
File No.

DECLASSIFIED BY SPE Jm/ks
DN 3/9/81

~~TOP SECRET~~

701447 22, 330

*CIA Info declassified per
John E. Bacon 8/27/80*

ARTHUR JAMES BALLETTI, et al.

~~CONFIDENTIAL~~

On May 3, 1961, Colonel Sheffield Edwards,
Director of Security, Central Intelligence Agency (CIA)
furnished the following information.

Colonel Edwards advised that in connection with
CIA's operation against Castro he personally contacted Robert
Maheu during the Fall of 1960 for the purpose of using Maheu
as a "cut-out" in contacts with Sam Giancana, a known hoodlum
in the Chicago area. Colonel Edwards said that since the
underworld controlled gambling activities in Cuba under the
Batista government, it was assumed that this element would
still continue to have sources and contacts in Cuba which
perhaps could be utilized successfully in connection with
CIA's clandestine efforts against the Castro government.
As a result, Maheu's services were solicited as a "cut-out"
because of his possible entree into underworld circles.
Maheu obtained Sam Giancana's assistance in this regard and
according to Edwards, Giancana gave every indication of
cooperating through Maheu in attempting to accomplish several
clandestine efforts in Cuba. Edwards added that none of
Giancana's efforts have materialized to date and that several
of the plans still are working and may eventually "pay off."

Colonel Edwards related that he had no direct
contact with Giancana; that Giancana's activities were
completely "back stopped" by Maheu and that Maheu would
frequently report Giancana's action and information to
Edwards. No details or methods used by Maheu or Giancana
in accomplishing their missions were ever reported to
Edwards. Colonel Edwards said that since this is "dirty
business" he could not afford to have knowledge of the actions
of Maheu and Giancana in pursuit of any mission for CIA.
Colonel Edwards added that he has neither given Maheu any
instruction to use technical installations of any type nor has
the subject of technical installations ever come up between
Edwards and Maheu in connection with Giancana's activity.

*downgraded
to CIA
GTT
6/17/80*

~~TOP SECRET~~

ENCLOSURE

ENCLOSURE

~~CONFIDENTIAL~~

62-11271-42

~~TOP SECRET~~

~~CONFIDENTIAL~~

Colonel Edwards related that Maheu did come to him concerning the arrest in Las Vegas of Balletti for "wire tapping." Maheu cautioned Edwards that the Balletti arrest could cause CIA some embarrassment since Balletti was in Las Vegas attempting to obtain coverage on some "Hollywood people" in connection with Giancana's efforts for CIA. Edwards said that he did not know the facts of the Balletti case and Maheu claims "Balletti went too far" in his efforts to obtain information. Edwards added that he was unaware of any reason for the activity of Maheu or Giancana in Las Vegas and that Giancana's activity in furtherance of the anti-Castro activity was left completely in Maheu's hands.

Colonel Edwards advised that only Mr. Bissell (Deputy Director of Plans, CIA) and two others in CIA were aware of the Giancana - Maheu activity in behalf of CIA's program and that Allen Dulles was completely unaware of Edwards' contact with Maheu in this connection. He added that Mr. Bissell, during his recent briefings of General Taylor and the Attorney General in connection with their inquiries into CIA relating to the Cuban situation, told the Attorney General that some of CIA's associated planning included the use of Giancana and the underworld against Castro.

"Property of FBI
This report and its contents are
loaned to you by the FBI and
neither it nor its contents are
to be distributed outside the agency
to which loaned."

- 2 -

~~CONFIDENTIAL~~

~~TOP SECRET~~

The Deputy Attorney General

April 22, 1975

Director, FBI

- 1 - Mr. J. B. Adams
- 1 - Mr. J. A. Mintz
- 1 - Mr. W. R. Wannall
- 1 - Mr. F. J. Cassidy

LETTER DATED MARCH 25, 1975, FROM
 JAMES N. ROETHE, STAFF ATTORNEY,
 COMMISSION ON CIA ACTIVITIES
 WITHIN THE UNITED STATES
 REQUEST FOR BUREAU DOCUMENTS

Reference is made to the letter dated March 25, 1975, to Mr. James A. Wilderotter, Associate Deputy Attorney General, from James N. Roethe, staff attorney, Commission on CIA Activities within the United States, in which Roethe requested "any documents in possession of the Bureau, including interoffice memoranda, showing a connection between CIA and known or suspected Mafia personalities specifically for, but not limited to, the period 1958 through 1965."

Enclosed is a memorandum, captioned "Commission on CIA Activities within the United States," identifying the documents in the possession of the Bureau responsive to Mr. Roethe's request and a copy of each of these documents for transmittal to him.

Enclosures - 6

FJC:aso (7)

ENCLOSURE

NOTE:

See memorandum W. R. Wannall to Mr. J. B. Adams, dated 4/21/75, captioned "Commission on CIA Activities within the United States (Rockefeller Commission)," prepared by FJC:aso.

- Assoc. Dir. _____
- Dep. AD Adm. _____
- Dep. AD Inv. _____
- Asst. Dir.:
- Admin. _____
- Comp. Syst. _____
- Ext. Affairs _____
- Files & Com. _____
- Gen. Inv. _____
- Ident. _____
- Inspection _____
- Intell. _____
- Laboratory _____
- Plan. & Eval. _____
- Spec. Inv. _____
- Training _____
- Legal Coun. _____
- Telephone Rm. _____
- Director Sec'y _____

REC-106

62-116391-1

MAILED 6
 APR 22 1975
 -FBI-

APR 24 1975

342
MAY 1 1975

TOP SECRET MATERIAL ATTACHED

MAIL ROOM

TELETYPE UNIT

April 22, 1975

**COMMISSION ON CIA
ACTIVITIES WITHIN
THE UNITED STATES**

1 - Mr. Adams
1 - Mr. Mintz
1 - Mr. Wannall
1 - Mr. Cassidy

Reference is made to the letter dated March 25, 1975, to Mr. James A. Wilderotter, Associate Deputy Attorney General, from James N. Roethe, staff attorney, Commission on CIA Activities within the United States, in which Mr. Roethe requested "any documents in possession of the Bureau, including interoffice memoranda, showing a connection between CIA and known or suspected Mafia personalities specifically for, but not limited to, the period 1958 through 1965."

A review of Bureau files reveals a number of documents pertaining to a connection between the CIA and hoodlums John Roselli and Sam Giancana. All pertinent information is contained in the following documents, copies of which are attached:

- 1) Memorandum W. R. Wannall to W. C. Sullivan, dated March 6, 1967, captioned "Central Intelligence Agency's Intentions to Send Hoodlums to Cuba to Assassinate Castro."
- 2) Memorandum from the Director, FBI, to the Attorney General, dated March 6, 1967, captioned as Item 1.
- 3) Memorandum dated May 22, 1961, captioned "Arthur James Balletti, et al," which contained results of an interview with Colonel Sheffield Edwards, who in 1961 was Director of Security, CIA.
- 4) Two memoranda from the Director of Security, CIA, dated May 18, 1966, and May 27, 1966, reporting additional meetings between CIA personnel and Roselli.

Assoc. Dir. _____
 Dep. AD Adm. _____
 Dep. AD Inv. _____
 Asst. Dir.:

- Admin. _____
- Comp. Syst. _____
- Ext. Affairs _____
- Files & Com. _____
- Gen. Inv. _____
- Ident. _____
- Inspection _____
- Intell. _____
- Laboratory _____
- Plan. & Eval. _____
- Spec. Inv. _____
- Training _____
- Legal Coun. _____
- Telephone Rm. _____
- Director Sec'y _____

Enclosures - 5

FJC:aso (6)

TOP SECRET MATERIAL ATTACHED

SEE NOTE PAGE TWO

ENCLOSURE

MAIL ROOM

TELETYPE UNIT

62-116371-43

**Commission on CIA
Activities within
The United States**

NOTE:

See memorandum W. R. Wannall to Mr. J. B. Adams, dated 4/21/75, captioned "Commission on CIA Activities within the United States (Rockefeller Commission)," prepared by FJC:aso. ~

UNITED STATES GOVERNMENT

Memorandum

~~TOP SECRET~~

- 1 - Mr. J. A. Mintz
(Attn: Dennis Miller)
- 1 - Mr. W. R. Wannall
- 1 - Mr. F. J. Cassidy

DATE: 5/2/75

- Assec. Dir. _____
- Dep. AD Adm. _____
- Dep. AD Inv. _____
- Asst. Dir.:
- Admin. _____
- Comp. Syst. _____
- Ext. Affairs _____
- Files & Com. _____
- Gen. Inv. _____
- Ident. _____
- Inspection _____
- Intell. _____
- Laboratory _____
- Plan. & Eval. _____
- Spec. Inv. _____
- Training _____
- Legal Coun. _____
- Telephone Rm. _____
- Director Sec'y _____

W

TO : Mr. J. A. Mintz *JAM*

FROM : Mr. W. R. Wannall *WRW*

SUBJECT: COMMISSION ON CIA ACTIVITIES
WITHIN THE UNITED STATES
(ROCKEFELLER COMMISSION)

DECLASSIFIED BY *SP4-Jum/koa*
ON *3/9/81* *7049422,330*
**CIA info declassified per*
John E. Bacon 8/27/80

Reference is made to the routing slip from the Legal Counsel Division dated 5/1/75, attaching a letter to the Deputy Attorney General from Mr. David W. Belin, Executive Director, Commission on CIA Activities Within the United States, in which letter, captioned Commission requested any information in the Department of Justice files concerning any efforts on the part of CIA to intervene in the ordinary course of civil or criminal investigations or litigation undertaken by the Department. Referenced LCD routing slip requested any information INTD could furnish concerning this matter by close of business 5/2/75.

a

INTD personnel in a position to be aware of such activity on the part of CIA have been canvassed with negative results and a review has been made of the file captioned "Relations With CIA," Bureau file 62-80750.

EX 104 REC-73 62-1163914

The only item developed which could be considered responsive to the Commission's request concerns information furnished to the Deputy Attorney General for transmittal to the Commission on 4/22/75. This item relates to an investigation by the Bureau in 1961 concerning an illegal wiretap which had been placed on the telephone of Dan Rowan of the comedy team of Rowan and Martin in Las Vegas, Nevada. It was determined the illegal wiretap was installed by one Arthur James Balletti. Balletti led us to former Special Agent Robert A. Maheu. On interview of Maheu, he stated the wiretap was installed on behalf of the CIA efforts to obtain Cuban intelligence data through the hoodlum element, including Sam Giancana. On contact with CIA, we learned of their involvement with Giancana and John Roselli, another top hoodlum, in connection with anti-Castro activities. We promptly disseminated the information to the Attorney General and Mr. Hoover was subsequently advised by then Attorney General Robert F. Kennedy that Kennedy had obtained the entire story from CIA and, because of CIA involvement, no prosecution was

FJC:vb(4)
62-116391

~~TOP SECRET~~

Classified by *4375*
Exempt from GDS, Categories 2 and 3
Date of Declassification Indefinite

ack
5-1-75
DAE

3rd
51 MAY 14 1975

~~TOP SECRET~~

Memorandum to Mr. J. A. Mintz

Re: Commission on CIA Activities Within the United States (Rockefeller Commission)
62-116391

possible, as such action which would involve Maheu and Giancana would
no doubt immediately bring out the fact that an agency of the United States
Government had approached Giancana to arrange for the assassination of
Castro. ~~(u)~~

ACTION:

This memorandum will be referred to the Legal Counsel Division for
their consideration in preparing a response to the Deputy Attorney General. *u*



~~TOP SECRET~~

UNITED STATES GOVERNMENT

Memorandum

TO : Mr. J. B. Adams

FROM : W. R. Wannall

SUBJECT: COMMISSION ON CIA ACTIVITIES
WITHIN THE UNITED STATES
(ROCKEFELLER COMMISSION)

- 1 - Mr. J. B. Adams
- 1 - Mr. W. V. Cleveland
- 1 - Mr. J. A. Mintz
- DATE: 4/8/75
- 1 - Mr. W. R. Wannall
- 1 - Mr. L. F. Schwartz
- 1 - Mr. F. J. Cassidy

Assoc. Dir. _____
 Dep. AD Adm. _____
 Dep. AD Inv. _____
 Asst. Dir.:

- Admin. _____
- Comp. Syst. _____
- Ext. Affairs _____
- Files & Com. _____
- Gen. Inv. _____
- Ident. _____
- Inspection
- Intell.
- Laboratory _____
- Legal Coun. _____
- Plan. & Eval. _____
- Spec. Inv. _____
- Training _____
- Telephone Rm. _____
- Director Sec'y _____

ALL INFORMATION CONTAINED
 HEREIN IS UNCLASSIFIED
 DATE 3/9/81 BY SP4 Jm/ka
 CIA info unclassified per
 John E. Bacon 8/27/80

By letter dated 3/25/75 to Mr. James A. Wilderotter, Associate Deputy Attorney General, Mr. James N. Roethe, staff attorney of captioned Commission, levied a number of requests for FBI documents to be supplied to the Commission.

One of the requests was for "any documents in possession of the Bureau, including interoffice memoranda, showing a connection between CIA and known or suspected Mafia personalities specifically for, but not limited to, the period 1958 through 1965."

A review of our files reveals a number of documents pertaining to a connection between the CIA and hoodlums John Roselli and Sam Giancana. All pertinent information is contained in the following documents:

- 1) memorandum W. R. Wannall to W. C. Sullivan, dated 3/6/67, captioned "Central Intelligence Agency's Intentions to Send Hoodlums to Cuba to Assassinate Castro";
- 2) memorandum from Director, FBI, to the Attorney General, dated 3/6/67, captioned as Item 1;
- 3) LHM dated 5/22/61, captioned "Arthur James Balletti, et al," which contains the results of an interview with Colonel Sheffield Edwards, who in 1961 was Director of Security, CIA.

In brief, we investigated Balletti in 1961 for placing an illegal wiretap. During the course of the investigation we determined that former Special Agent Robert H. Maheu was involved. Interview of Maheu surfaced a relationship between John Roselli and Sam Giancana, top hoodlums, and the CIA.

In addition, our files contain a letter dated 5/18/66 and a letter 5/27/66 from the Director of Security of CIA which reported contacts between Roselli and CIA officials in 1966, which letters would appear pertinent to Mr. Roethe's request.

Enclosures
 62-116391
 FJC:aso (7)

CONTINUED - OVER

ENCLOSURE

TOP SECRET MATERIAL ATTACHED

APR 25 1975

5-COT

84 JUN 26 1975

No follow made on any of said documents. That pertains to Roselli. Forwarded to Roselli. 62-116391-4559

Memorandum to Mr. J. B. Adams
Re: Commission on CIA Activities
Within the United States
(Rockefeller Commission)
62-116391

It is proposed that the above-mentioned communications be furnished to Mr. Roethe in response to his request. As the documents contain some information furnished to us by CIA on a strict need-to-know basis with a request that the information not be released outside the FBI without prior coordination with CIA, the Intelligence Division (INTD) through Liaison will obtain the necessary clearance from CIA to furnish same to the Commission.

The Special Investigative Division (SID) is requested to review the attached documents as the documents pertain to investigations of primary concern to SID and advise if SID interposes any objection to furnishing the documents to the Commission. u

ACTION:

1. SID review the attached documents in line with the above. u
2. If SID interposes no objection to furnishing the attached documents to the Commission, INTD through Liaison will obtain CIA clearance to furnish the documents to the Commission and thereafter prepare the necessary cover communication to transmit the documents to Mr. Roethe. u

pin WNC
JMB
JMB
u(RW)

ROUTE IN ENVELOPE

TOP SECRET

DECLASSIFIED BY SP-1 JMK/CAW
ON 3/9/81 FOIPA # 22,370

The Attorney General

March 6, 1967

Director, FBI

*CIA info Declassified per John E. Bacon 8/27/80

CENTRAL INTELLIGENCE AGENCY'S
INTENTIONS TO SEND HOOGLUMS TO
CUBA TO ASSASSINATE CASTRO

in 62-90750-455

Our files contain the following information concerning the captioned matter, much of which has been furnished by the Central Intelligence Agency (CIA) on a strictly highly confidential "need-to-know" basis. In view of this, it is requested that it be handled on a most restrictive basis. (u)

This matter first came to our attention in the Spring of 1961 in connection with our investigation of a violation of the Unauthorized Publication or Use of Communications Statute on the part of Arthur James Balletti, who had been arrested by local authorities in Las Vegas, Nevada, on a local wire tapping charge. Balletti and another unidentified individual in October, 1960, had reportedly placed a wire tap on the telephone of Dan Rowan, a member of the comedy team of Rowan and Martin. Rowan at the time reportedly was engaged to Phyllis McGuire of the well-known McGuire Sisters singing trio who was also known to be a girl friend of Sam Giancana, a top hoodlum.

During the course of the Balletti investigation it was ascertained that Robert A. Mahou, a private detective, was involved. Mahou during interview claimed he ordered coverage of Rowan in behalf of CIA's efforts to obtain intelligence information in Cuba through the hoodlum element, including Sam Giancana, which had interest there. Mahou said he was put in contact with Giancana in connection with these intelligence activities through John Roselli, a Los Angeles hoodlum. Mahou stated also that he authorized the wiring of Rowan's room and had discussed the matter with Roselli.

The essence of the above was furnished to former Attorney General Robert F. Kennedy by letter dated May 22, 1961, which enclosed a memorandum of the same date containing data made available on May 3, 1961, by Colonel Sheffield Edwards, who at that time was Director of Security at CIA, regarding his utilization of Mahou in connection with anti-Castro activities. Since our files show that Mr. Kennedy returned the original of our letter and its enclosed memorandum dated May 22, 1961,

Classified by 6009
Exempt from automatic
downgrading and
declassification
Date of Declassification Indefinite

TOP SECRET

62-11059-5

ENCLOSURE

GROUP 1
Excluded from automatic
downgrading and
declassification

The Attorney General

to us for filing purposes, a copy of the May 22, 1961, memorandum is attached hereto for your information. *(u)*

You will note that Colonel Edwards advised he personally contacted Robert Mahou during the Fall of 1960 for the purpose of using Mahou as a "cutout" in contacts with Sam Giancana in connection with CIA's clandestine efforts against Castro. Colonel Edwards stated that Giancana's activities were completely "backstopped" by Mahou, who would frequently report Giancana's actions and information to Edwards. No details or methods used by Mahou or Giancana in accomplishing their missions were reported to him, according to Edwards, as such involved "dirty business," of which Colonel Edwards could not afford to have knowledge. Accordingly, he said he had no prior knowledge of the above-mentioned wire tapping by Balletti. *(u)*

Further with respect to this matter, I was informed of the following on a highly confidential basis by former Attorney General Kennedy during a conference in my office on May 9, 1962:

He indicated that a few days prior thereto he had been advised by CIA that Robert A. Mahou had been hired by CIA to approach Sam Giancana with a proposition of paying \$150,000 to hire some gunmen to go into Cuba and kill Castro. He further stated CIA admitted having assisted Mahou in making the "bugging" installation in Las Vegas (referred to above) which uncovered this clandestine operation and for this reason CIA could not afford to have any action taken against Giancana or Mahou. Mr. Kennedy stated that upon learning CIA had not cleared its action in hiring Mahou and Giancana with the Department of Justice he issued orders that CIA should never again take such steps without first checking with the Department of Justice.

Mr. Kennedy further advised that because of this matter it would be very difficult to initiate any prosecution against Giancana, as Giancana could immediately bring out the fact the United States Government had approached him to arrange for the assassination of Castro. He stated the same was true concerning any action we might take against Mahou for any violation in which he might become involved.

On June 20, 1962, Mr. William Harvey, an official of CIA, advised that he had held a meeting with John Roselli (referred to above as Mahou's link with Giancana) for the purpose of closing out the entire matter with which Roselli had been involved. In this connection, Harvey stated that CIA had

The Attorney General

established contact with Roselli in "early 1961" with respect to a sensitive operation against Castro. Harvoy said that for all intents and purposes the operation was discontinued and canceled after the ill-fated Bay of Pigs invasion in April, 1961, but Roselli had not been completely cut off, as he periodically indicated he was in a position to be of assistance.

It appears Roselli has since that time, nevertheless, used his prior connections with CIA to his best advantage. For example, in May, 1966, when contacted by Agents of this Bureau in connection with our current investigation of his activities he refused to talk and immediately flew to Washington, D. C., and consulted with Colonel Sheffield Edwards, who is now retired from CIA. Colonel Edwards in turn advised CIA, which told us. Mr. Howard J. Osborn, the present Director of Security, CIA, freely has admitted to us that Roselli has CIA in an unusually vulnerable position and that he would have no qualms about embarrassing CIA if it served his own interests. In furnishing this information, Mr. Osborn stated that it be held within this Bureau on a strictly need-to-know basis. ~~(S)~~ (U)

In light of the above information furnished us by CIA and former Attorney General Kennedy, it appears that data which came to our attention in October, 1960, possibly pertains to the captioned matter. At that time a source close to Giancana advised that during a conversation with several friends Giancana stated that Fidel Castro was "to be done away with very shortly." Giancana reportedly assured those present that Castro's assassination would occur in November, 1960, and that he had already met with the assassin-to-be on three occasions, the last meeting having taken place on a boat docked at the Fontainebleau Hotel, Miami Beach, Florida. Reportedly, Giancana claimed that everything had been perfected for the killing and the "assassin" had arranged with a girl, not further described, to drop a "pill" in Castro's drink or food.

Also of possible interest is a news article carried in the August 13, 1963, issue of the "Chicago Sun Times." This article carried the headline, "CIA Sought Giancana's Help For Cuba Spying," and it was reported therein that CIA agents had contacted Giancana in an effort to obtain Cuban intelligence after Castro came into power. ✓

Enclosure

1 - The Deputy Attorney General

~~TOP SECRET~~

The Attorney General

NOTE:

See cover memorandum Wannall to Sullivan, same caption,
March 6, 1967, GCM:ams. ~

Classified "Top Secret" inasmuch as information contained
herein is so classified by CIA. ~

- 4 -
~~TOP SECRET~~

~~TOP SECRET~~

ROUTE IN ENVELOPE

DECLASSIFIED BY *SP-5 JWA/KO*
ON *3/9/81* *7/22/83*

CIA Staff Declassified by
John E. Bacon 8/27/80

N. C. Sullivan

March 6, 1967

N. R. Farnall

Classified by *W2A*
Exempt from automatic
downgrading and
declassification

WATSON
my in
62-116391-4559

CENTRAL INTELLIGENCE AGENCY'S
INTENTIONS TO SEND HOODLUMS TO
CUBA TO ASSASSINATE CASTRO

In accordance with instructions, attached letter has been prepared for Attorney General setting forth all data in our files concerning captioned matter. Briefly, information being furnished is as follows: ~

Matter first came to our attention in Spring of 1961 in connection with our investigation of violation of Unauthorized Publication or Use of Communications Statute on the part of Arthur James Dalletti, arrested in Las Vegas, Nevada, by local authorities on wire tapping charge. Wire tap involved was on telephone of Dan Rowan, member of Rowan and Martin comedy team. Rowan at the time reportedly was engaged to Phyllis McGuire, girl friend of top hoodlum Sam Giancana and member of McGuire Sisters' singing trio. ~

Through our investigation we determined involvement of Robert A. Mahou, private detective, who stated coverage on Rowan instituted in behalf of Central Intelligence Agency (CIA) efforts to obtain Cuban intelligence data through hoodlum element, including Sam Giancana. Mahou was in contact with Giancana through services of John Roselli, another hoodlum, and Mahou authorized wiring of Rowan's room.

We checked matter with CIA on 5/3/61 and learned CIA was utilizing Mahou as intermediary with Sam Giancana relative to CIA's "dirty business" anti-Castro activities. CIA insisted it did not give Mahou any instructions relative to use of technical installations. By letter 5/22/61 we furnished former Attorney General Kennedy a memorandum containing a rundown on CIA's involvement in this. The originals of the letter and memorandum were returned to us for filing purposes. A copy of that memorandum is being attached to instant letter being sent to Attorney General. *X(u)*

On 5/9/63 Kennedy discussed with the Director a number of matters, including admission by CIA that Robert Mahou had been

Enclosure

62-116391-59
CONTINUED - OVER

~~TOP SECRET~~

~~TOP SECRET~~

Memorandum for Mr. Sullivan:
Re: CENTRAL INTELLIGENCE AGENCY'S
INTENTIONS TO SEND HOODLUMS TO
CUBA TO ASSASSINATE CASTRO

hired by that Agency to approach Sam Giancana to have Castro assassinated at a cost of \$150,000. Kennedy stated he had issued orders that CIA should never undertake such steps again without first checking with Department of Justice and stated because of this matter it would be difficult to prosecute Giancana or Mahou then or in the future.

We learned on 6/20/63 from CIA that its contacts with John Roselli (Mahou's link with Giancana) had continued up until that time, when they were reportedly cut off.

It appears Roselli is using his prior connections with CIA to his best advantage. In May, 1966, when Bureau Agents endeavored to interview him he immediately flew to Washington and informed his former CIA intermediary. The current Director of Security, CIA, has advised through liaison channels that Roselli has CIA in an unusually vulnerable position and Roselli would have no qualms about embarrassing CIA to serve his own interests. In furnishing this information we were asked that it be held within this Bureau on a strictly need-to-know basis. We have, however, included it in the attached proposed letter to the Attorney General noting this CIA specific restriction. *X(u)*

We have two other references in our files to the over-all above information which we have included in the letter. One relates to a statement by Giancana in October, 1960, that he had met with an individual who was to assassinate Castro in November, 1950. The other is an article in the 8/16/63 issue of the "Chicago Sun Times" reporting that CIA agents had contacted Giancana to obtain Cuban intelligence.

ACTION:

If approved, attached letter will be sent to the Attorney General, with a copy for the Deputy Attorney General. *u*

~~TOP SECRET~~

May 22, 1961

~~CONFIDENTIAL~~

ARTHUR JAMES BALLETTI, et al.

On May 3, 1961, Colonel Sheffield Edwards, Director of Security, Central Intelligence Agency (CIA) furnished the following information.

Colonel Edwards advised that in connection with CIA's operation against Castro he personally contacted Robert Mahou during the fall of 1960 for the purpose of using Mahou as a "cut-out" in contacts with Sam Giancana, a known hoodlum in the Chicago area. Colonel Edwards said that since the underworld controlled gambling activities in Cuba under the Batista government, it was assumed that this element would still continue to have sources and contacts in Cuba which perhaps could be utilized successfully in connection with CIA's clandestine efforts against the Castro government. As a result, Mahou's services were solicited as a "cut-out" because of his possible entry into underworld circles. Mahou obtained Sam Giancana's assistance in this regard and according to Edwards, Giancana gave every indication of cooperating through Mahou in attempting to accomplish several clandestine efforts in Cuba. Edwards added that none of Giancana's efforts have materialized to date and that several of the plans still are working and may eventually "pay off."

Colonel Edwards related that he had no direct contact with Giancana; that Giancana's activities were completely "back stopped" by Mahou and that Mahou would frequently report Giancana's action and information to Edwards. No details or methods used by Mahou or Giancana in accomplishing their missions were ever reported to Edwards. Colonel Edwards said that since this is "dirty business" he could not afford to have knowledge of the actions of Mahou and Giancana in pursuit of any mission for CIA. Colonel Edwards added that he has neither given Mahou any instruction to use technical installations of any type nor has the subject of technical installations ever come up between Edwards and Mahou in connection with Giancana's activity.

*downgrade to Conf per IA memo dtd 12/21/76
by G-7, 12/17/76 JAG. Not. in 139-800143*

DECLASSIFIED BY *SP4 Gm/Kew*
ON *3/9/81*

TOP SECRET

~~CONFIDENTIAL~~

**C.I.A. Info. declassified per
John E. Bacon 8/27/80*

ENCLOSURE

62-116397-59

~~TOP SECRET~~

~~CONFIDENTIAL~~

Colonel Edwards related that Kabeu did come to him concerning the arrest in Las Vegas of Balletti for "wire tapping." Kabeu cautioned Edwards that the Balletti arrest could cause CIA some embarrassment since Balletti was in Las Vegas attempting to obtain coverage on some "Hollywood people" in connection with Giancana's efforts for CIA. Edwards said that he did not know the facts of the Balletti case and Kabeu claims "Balletti went too far" in his efforts to obtain information. Edwards added that he was unaware of any reason for this activity of Kabeu or Giancana in Las Vegas and that Giancana's activity in furtherance of the anti-Castro activity was left completely in Kabeu's hands.

Colonel Edwards advised that only Mr. Bissell (Deputy Director of Plans, CIA) and two others in CIA were aware of the Giancana - Kabeu activity in behalf of CIA's program and that Allen Dulles was completely unaware of Edwards' contact with Kabeu in this connection. He added that Mr. Bissell, during his recent briefings of General Taylor and the Attorney General in connection with their inquiries into CIA relating to the Cuban situation, told the Attorney General that some of CIA's associated planning included the use of Giancana and the underworld against Castro.

~~TOP SECRET~~

~~CONFIDENTIAL~~

UNITED STATES GOVERNMENT

Memorandum

TO : Mr. J. B. Adams

DATE: 5/21/75

FROM : Legal Counsel *[Signature]*

SUBJECT: STATUS OF RESPONSES TO
CONGRESSIONAL COMMITTEE REQUESTS

Assoc. Dir. _____
 Dep. AD Adm. _____
 Dep. AD Inv. _____
 Asst. Dir. _____
 Admin. _____
 Comp. Syst. _____
 Ext. Affairs _____
 Files & Com. _____
 Gen. Inv. _____
 Ident. _____
 Inspection _____
 Intell. _____
 Laboratory _____
 Plan. & Eval. _____
 Spec. Inv. _____
 Training _____
 Tele. Rm. _____
 Director Sec'y _____

[Signature]

The purpose of this memorandum is to set forth in summary form the requests we have received from various Committees in Congress and the status of our replies. U

Senate Select Committee on Intelligence Activities - Church Committee

We have substantially complied with requests from the Committee contained in their letter of 3/19/75. The remaining aspects of these requests involve decisions by the Department of Justice concerning COINTELPRO and our recommendation that one particular document not be furnished the Committee. U

Responses to the Senate Select Committee request of 4/30/75, which generally pertains to sections of the Manual of Rules and Regulations, the Manual of Instruction, Bureau forms, indexing information and classification materials has been partially complied with. We have received Departmental approval to make sections of the Manual of Rules and Regulations and the Manual of Instruction available to the Committee. Responses to the other aspects of this particular request are in various stages of approval at Headquarters. U

We have furnished a response to the Senate Select Committee of 4/28/75, concerning allegations of our possible involvement in the removal of documents from the residence of the late Director J. Edgar Hoover.

- 1 - Mrs. Metcalf
- 1 - Mr. Wannall (Attn: Mr. Cregar)
- 1 - Mr. Mintz
- 1 - Mr. Hotis
- 1 - Mr. Daly

MAY 29 1975

62-116391-
NOT RECORDED
170 MAY 29 1975

[Handwritten initials]

PVD:mfd (6)

CONTINUED - OVER

56 JUN 14 1975

F 330

ALL INFORMATION CONTAINED
 HEREIN IS UNCLASSIFIED
 DATE 3/10/81 BY SP4-Jmk/ka
 *CIA INFO unclassified per
 John E. Bacon 8/27/80

Memorandum to Mr. Adams
Re: Status of Responses to Congressional Committee Requests

A request of this Committee dated 5/12/75, concerning allegations of CIA's involvement in a plot to kill Castro has been responded to in that we advised the Department that CIA would have to give clearance before these documents could be furnished the Committee. Concerning this particular request, CIA has contacted the Department and the Senate Select Committee has reviewed the material in the Department with the approval of CIA. This procedure was approved by Deputy Attorney General Tyler. The material was reviewed by Chief Counsel F. A. O. Schwarz and Minority Counsel Curtis Smothers.

By letter dated 5/14/75, we received a lengthy request from the Committee which pertains to among other things information concerning all wiretaps including their location and other requests which would amount to a complete reconstruction of Bureau files, as well as Inspection surveys for ten offices. Mark Gitenstein and John Elliff, of the Committee staff, both indicated that this particular request should be considered entirely negotiable, however K. William O'Connor, Deputy Assistant Attorney General of the Department, who indicated that he was going to negotiate with the Committee on this matter, has not contacted the Committee to engage in such negotiations. We are, however, going over this request and where necessary preparing the responses. ~

Subcommittee on Civil and Constitutional
Rights of the House Judiciary Committee (Edwards Committee)

We have complied with all aspects of this Committee's request which was contained in their letter of 4/10/75 with the exception of one response pertaining to our authority to collect, retain and disseminate information which is in the process of receiving Bureau approval. In this regard it is to be noted that on 5/19/75, we received a complaint from Arden Schell, staff member of the Committee, that the Committee had not received our responses. We delivered our responses to the other aspects of the 4/10/75 request to the Department on 4/24/75 and 5/1/75, respectively. This matter has been brought to the attention of K. William O'Connor as well as Associate Deputy Attorney General Robert McDermott. ~

A. Mintz
Mr. J. B. Hotis)
R. Wannall
Mr. W. O. Cregar
R. Dickson

ALL INFORMATION CONTAINED
HEREIN IS UNCLASSIFIED

The Attorney General
Director, FBI

DATE 3/2/81 BY SP4 JRM/KZA
May 29, 1975
FOIPA # 22,330

Rockefeller Commission
CIA Info unclassified per let of
John E. Bacon 8/27/80

UNITED STATES SENATE SELECT COMMITTEE
ON INTELLIGENCE ACTIVITIES

This is in response to a request on May 19, 1975,
that we review our files for any information concerning
possible U. S. Government involvement in a plot to assassinate
the former Dominican Republic Dictator Raphael Leonidas
Trujillo.

A review was conducted of logical files; however, no
information was located indicating U. S. Government involve-
ment in the assassination of Trujillo, with the exception of
several recent newspaper articles which implicated the
Central Intelligence Agency in the assassination of Trujillo.

62-116398 According to PV Daly, this was a
Rockefeller Commission request, not that of
1 - The Deputy Attorney General SSC + should then be
DRD: cmc cmc
(9) 1 *file in 62-116391B*
hand delivered by R. DALY 5-29-75
John not deliv to Com

NOTE: JUL 8 1975 4 REG-102 62-116391-60
Reference is made to Legal Counsel memorandum to
Mr. J. B. Adams 5/20/75, captioned "SENSTUDY - 75," wherein it
was indicated that on 5/19/75, it was requested that the Bureau
determine through its files what information they might have
concerning possible Government involvement in a plot to assas-
sinate Dominican Republic Dictator Raphael Trujillo. Informatio
re the 5/19/75 conversation furnished orally by Director to
Mr. Adams. *W's JUL 8 1975*

- Assoc. Dir. _____
- Dep. AD Adm. _____
- Dep. AD Inv. _____
- Asst. Dir. _____
- Admin. _____
- Comp. Syst. _____
- Ext. Affairs _____
- Files & Com. _____
- Gen. Inv. _____
- Ident. _____
- Inspection _____
- Intell. _____
- Laboratory _____
- Plan. & Eval. _____
- Spec. Inv. _____
- Training _____
- Off. Cong. & Public Affs. _____
- Telephone Rm. _____
- Director's Sec'y _____

In this regard, all sections of the main file on
Trujillo (109-485), as well as a Correlation Summary dated
9/26/74 prepared from a review of all "see" references to
the subject, were reviewed with negative results. Additionally,
in connection with a recent request from the Rockefeller
Commission concerning any information in Bureau files which would
show connection of CIA with Mafia personalities, a review was
made by IS-3 of the CIA relations files, specifically directed
to any information concerning CIA involvement in assassination
attempts. Review failed to develop any information regarding
CIA involvement in a plot to assassinate Rafael Trujillo.

4 10/20/75 TELETYPE UNIT

✓ S. F. Phillips - 4063 818 *W's gpg*

UNRECORDED COPY FILED IN

FEDERAL BUREAU OF INVESTIGATION
FREEDOM OF INFORMATION/PRIVACY ACTS SECTION

SUBJECT: FIDEL CASTRO

FILE NUMBER: 62-109060 CROSS-REFERENCES

Memorandum

REC

TO : Mr. DeLoach

DATE: March 22, 1967

FROM : A. Rosen

3040
4/17/67

- 1 - Mr. DeLoach
- 1 - Mr. Rosen
- 1 - Mr. Malley
- 1 - Mr. Shroder
- 1 - Mr. Raupach
- 1 - Mr. Sullivan

SUBJECT: ASSASSINATION OF PRESIDENT
JOHN FITZGERALD KENNEDY
NOVEMBER 22, 1963
DALLAS, TEXAS

The attached sets forth the results of an interview with Edward P. Morgan (former Bureau Inspector) on 3/20/67.

By way of background, during February, 1967, James J. Rowley, U. S. Secret Service, advised that Drew Pearson, contacted Chief Justice Warren concerning information in possession of Edward P. Morgan. The Chief Justice refused to see Morgan, however, it was determined Morgan alleged that former Attorney General Robert F. Kennedy organized a group to go to Cuba to kill Castro. All of this group were killed or imprisoned except one person who escaped, and subsequently, after Castro learning of the plot, decided to utilize the same procedure to kill President Kennedy and that he hired Oswald to do the job. This information allegedly came from a client of Morgan. Secret Service made an appointment to talk to Morgan; however, he never showed up.

On 3/17/67, Mr. Watson at the White House advised that President Johnson desired the FBI to interview Morgan concerning any knowledge he might have had concerning the assassination of President Kennedy.

Morgan was interviewed on 3/20/67 by Washington Field Office Agents. Due to attorney-client relationship, Morgan would not identify the persons who furnished him information concerning the assassination. He stated his clients, while not directly involved in the assassination, had knowledge of the plot. Morgan alleges his clients were used by a Government Agency (obviously Central Intelligence Agency, CIA) to plot the assassination of Fidel Castro, and that Castro learned of the plot, and thereafter, dispatched teams of assassins to the U. S. for the purpose of assassinating President Kennedy. He said his clients were aware of the identity of some of these individuals, and he understood that two such individuals were

67-109060-4984

KMR:des

(7)

Enclosures

RECORDED - OVER

PLAS. REC. UNIT

6/1/67

Memorandum Report to DeLoach
RE: ASSASSINATION OF PRESIDENT JFK [REDACTED]

Morgan also stated that one of the clients he represented was a high type individual of the Catholic faith. When he queried this individual as to why he became involved in such a project as the assassination of Castro, his client indicated the project was so highly patriotically motivated that this overrode personal ethical or moral considerations.

During 1961, we conducted an investigation of a violation of Unauthorized Publication or Use of Communication Statute on the part of Arthur James Palletti, arrested in Las Vegas, Nevada, by local authorities on a wire tapping charge. Our investigation determined this involved Robert A. Maheu,* private detective, that coverage was instituted in behalf of CIA's efforts to obtain Cuban intelligence data through hoodlum element. [REDACTED]

We checked with CIA and learned CIA was utilizing Maheu as an intermediary with Sam Giancana, relative to CIA's "dirty business" anti-Castro activities. On 5/22/61 we furnished the then Attorney General Kennedy a memorandum containing the rundown of CIA's involvement of this which involved Maheu who had been hired by CIA to approach Sam Giancana to have Castro assassinated at a cost of \$150,000. On 5/9/62 Kennedy advised he had issued orders that CIA should never undertake such steps again without first checking with the Department of Justice. [REDACTED]

This information is briefly set forth in the enclosure as it appears to relate to information in Morgan's possession. Since CIA furnished information on a strictly highly confidential "need-to-know" basis and requested that it be handled on a most restrictive basis, this is being set forth in the communications attached.

ACTION:

Attached for approval is a letter to Mrs. Stegall at the White House, the Attorney General, and James J. Rowley, U. S. Secret Service, enclosing a memorandum setting forth the information furnished by Morgan, and information received from CIA. The enclosures to these communications are classified Top Secret.

*former Special Agent

[REDACTED]

**ASSASSINATION OF PRESIDENT JOHN
FITZGERALD KENNEDY**

He related that when he first heard the story from his clients he did not believe it, but conducted enough inquiry to satisfy himself that his clients had some basis in fact for their position and he felt they were telling the truth. He pointed out he represented substantial citizens, people who loved their country and had a high regard for the then President. If their story came out now, they would be damaged by the resultant publicity, and some prosecutor of the same type as District Attorney Garrison of New Orleans could conceivably attempt to initiate prosecution against them. At this point he noted that the charge against them might well be conspiracy to kill, which is a crime, and in the case of his clients the Statute of Limitations has not run.

In explaining this remark he pointed out that if he were a Government investigator assigned to unravel all facets of the assassination of President Kennedy, he would first concern himself with reading the newspaper articles dealing with the topic of a Castro plot. He said he would examine the Castro plot to determine precisely what bearing it had on the assassination of the President. He indicated the newspaper articles had considerable merit and were on the right track in regard to the theory of the assassination.

Without making any factual representations, and continuing to theorize, he went on to relate that his clients, whom he again characterize as respectable citizens, were called upon by a Governmental agency to assist in a project which was said to have the highest Governmental approval. The project had as its purpose the assassination of Fidel Castro, Premier of Cuba. Elaborate plans involving many people were made. These plans included the infiltration of the Cuban Government and the placing of informants in key posts within Cuba. The project almost reached fruition when Castro became aware of it and arrested a number of suspects. By pressuring captured suspects he was able to learn the full details of the plot against him and decided "if that was the way President Kennedy wanted it, he too could engage in the same tactics." Castro thereafter employed teams of individuals who were dispatched to the United States for the purpose of assassinating President Kennedy. ~~Mr. [REDACTED]~~ further

March 21, 1967

ASSASSINATION OF PRESIDENT
JOHN FITZGERALD KENNEDY
NOVEMBER 22, 1963, DALLAS, TEXAS

Declassified
2040
6/25/77, CAC

On the evening of March 20, 1967, Attorney Edward P. Morgan,
300 Farragut Building, Washington, D. C., furnished the following
information relating to the assassination of President John F. Kennedy.

He advised that while this covered a wide range or field, it probably arose as the result of comments he made during conversations in which he suggested Lee Harvey Oswald was not the only person involved in the crime. He stated that he did have information pertaining to the assassination which he considered pertinent and relevant. He said it was necessary for him, in his capacity of attorney, to invoke the attorney-client privilege, since the information in his possession was derived as a result of that relationship. He added that it was still possible for his clients to be prosecuted. He pointed out that he was not stating or implying his clients were either directly or indirectly involved in the death of President Kennedy or could be prosecuted in this regard. However, they definitely face possible prosecution for a crime not related to the assassination of Kennedy. Due to their participation in this crime, his clients learned of information pertaining to the President's assassination. Mr. Morgan said he represented these clients on this specific matter. He did not elaborate on when they sought his legal counsel and he indicated he could not fulfill his responsibility and identify them. He said he gave considerable thought to finding some way to make this information available to the Federal Bureau of Investigation, but as yet had not come up with a solution. He considered a possible waiver from his clients but decided against this because the type of protection they needed was for some competent authority to grant them complete immunity, not only from prosecution but from the publicity that would surely follow. If in the future it becomes possible to overcome all legal obstacles, he will immediately make this information available to the Government and, more particularly, the Federal Bureau of Investigation.

4987 X

GROUP 1
Excluded from automatic
downgrading and
declassification

[REDACTED]

**ASSASSINATION OF PRESIDENT
JOHN FITZGERALD KENNEDY**

explained that his clients (here noting that he, Morgan, was employed by more than one of those involved) obtained information concerning Castro's dispatch of these assassins from "feed back" furnished by sources close to Castro. Continuing, he said his clients were aware of the identity of some of the individuals who came to the United States for this purpose and he understood that two such individuals were now in the State of New Jersey.

Mr. Morgan further noted that one of the clients he represented was a high type individual of the Catholic faith. Morgan said he queried him as to why a person with his high ethical standard had ever become involved in such a project as the assassination of Fidel Castro. The client indicated that his conscience bothered him; however, the project was so highly patriotically motivated that this, in his mind, overrode personal ethical or moral considerations. He further described how one client, when hearing the statement that Lee Harvey Oswald was the sole assassin of President Kennedy, "laughs with tears in his eyes and shakes his head in apparent disagreement."

Mr. Morgan said if he were free of the attorney-client privilege to furnish full details, the information that he would be able to supply would not directly identify the alleged conspirators to kill President Kennedy. However, because of the project to kill Fidel Castro, those participating in the project whom he represents developed through feed back information that would identify Fidel Castro's counter-assassins in this country, who could very well be considered suspects in such a conspiracy. Morgan pointed out that from the information available to him from his clients he could not declare or conclude that Lee Harvey Oswald could not have committed this assassination alone.

Mr. Morgan pointed out that it was inconceivable to him that an agency of the Government which engages in the type of operations which he has described has not come forth to make this most important data available to the Warren Commission. He declined to identify the

[REDACTED]

**ASSASSINATION OF PRESIDENT
JOHN FITZGERALD KENNEDY**

name of the agency but indirectly described it as the investigative agency which conducts intelligence-type investigations outside the United States.

In conclusion, Mr. Morgan reiterated that he would immediately contact the Federal Bureau of Investigation if he discovered any way to reveal the full details of this matter.

In connection with the above it may be of interest to note that during 1961, an investigation was conducted concerning a violation of the Unauthorized Publication or Use of Communications Statute on the part of Arthur James Balletti, who had been arrested by local authorities in Las Vegas, Nevada, on a wire tapping charge. During the course of the Balletti investigation it was ascertained that Robert A. Maheu, a private detective, was involved. Maheu claimed he placed wire taps in behalf of CIA's efforts to obtain intelligence information in Cuba through the hoodlum element, including Sam Giancana. Maheu said he was placed in contact with Giancana in connection with these intelligence activities through John Roselli, a Los Angeles hoodlum.

A representative of the CIA stated he personally contacted Maheu during the Fall of 1960 for the purpose of using Maheu as a "cutout" in contacts with Sam Giancana in connection with CIA's clandestine efforts against Castro.

On May 9, 1962, former Attorney General Kennedy advised that a few days prior thereto he had been advised by CIA that Robert A. Maheu had been hired by CIA to approach Sam Giancana with a proposition of paying \$150,000 to hire some gunmen to go into Cuba and kill Castro. He further stated CIA admitted having assisted Maheu in making the "bugging" installation in Las Vegas (referred to above) which uncovered this clandestine operation and for this reason CIA could not afford to have any action taken against Giancana or Maheu. Mr. Kennedy stated that upon learning CIA had not cleared its action in hiring Maheu and Giancana with the Department of Justice he issued orders that CIA should never again take such steps without first checking with the Department of Justice.

UNITED STATES GOVERNMENT

Memorandum

Mr. Tolson	_____
Mr. DeLoach	_____
Mr. Mohr	_____
Mr. Bishop	_____
Mr. Casper	_____
Mr. Callahan	_____
Mr. Conrad	_____
Mr. Felt	_____
Mr. Gale	_____
Mr. Rosen	_____
Mr. Sullivan	_____
Mr. Tavel	_____
Mr. Trotter	_____
Tele. Room	_____
Mr. Holmes	_____
Miss Gandy	_____

TO : DIRECTOR

DATE: 3/27/67

FROM : CLYDE TOLSON

[Redacted]

SUBJECT:

Please note page 4 of the memorandum dated March 21, 1967

which was sent to Mrs. Stegall at the White House by the attached letter of March 22, and which covers the negotiations between Robert A. Maheu, acting for CIA, and Sam Giancana.

AM

TII

noted

CT:DSS

*File to OGC to advise re
request to inform SSC on
Intelligence of Communications
SEC/dmb 4/27/77*

REC-75

5080

9 APR 18 1967

103

AM

[Redacted]

[Redacted]

[Redacted]

DECLASSIFIED
2040, 670

APR 20 1967

March 21, 1967

ASSASSINATION OF PRESIDENT
JOHN FITZGERALD KENNEDY
NOVEMBER 22, 1963, DALLAS, TEXAS

On the evening of March 20, 1967, Attorney Edward P. Morgan,
320 Farragut Building, Washington, D. C., furnished the following
information relating to the assassination of President John F. Kennedy.

He advised that while this covered a wide range or field, it probably arose as the result of comments he made during conversations in which he suggested Lee Harvey Oswald was not the only person involved in the crime. He stated that he did have information pertaining to the assassination which he considered pertinent and relevant. He said it was necessary for him, in his capacity of attorney, to invoke the attorney-client privilege, since the information in his possession was derived as a result of that relationship. He added that it was still possible for his clients to be prosecuted. He pointed out that he was not stating or implying his clients were either directly or indirectly involved in the death of President Kennedy or could be prosecuted in this regard. However, they definitely face possible prosecution for a crime not related to the assassination of Kennedy. Due to their participation in this crime, his clients learned of information pertaining to the President's assassination. Mr. Morgan said he represented these clients on this specific matter. He did not elaborate on when they sought his legal counsel and he indicated he could not fulfill his responsibility and identify them. He said he gave considerable thought to finding some way to make this information available to the Federal Bureau of Investigation, but as yet had not come up with a solution. He considered a possible waiver from his clients but decided against this because the type of protection they needed was for some competent authority to grant them complete immunity, not only from prosecution but from the publicity that would surely follow. If in the future it becomes possible to overcome all legal obstacles, he will immediately make this information available to the Government and, more particularly, the Federal Bureau of Investigation.

5084
RECEIVED

[REDACTED]

**ASSASSINATION OF PRESIDENT JOHN
FITZGERALD KENNEDY**

He related that when he first heard the story from his clients he did not believe it, but conducted enough inquiry to satisfy himself that his clients had some basis in fact for their position and he felt they were telling the truth. He pointed out he represented substantial citizens, people who loved their country and had a high regard for the then President. If their story came out now, they would be damaged by the resultant publicity, and some prosecutor of the same type as District Attorney Garrison of New Orleans could conceivably attempt to initiate prosecution against them. At this point he noted that the charge against them might well be conspiracy to kill, which is a crime, and in the case of his clients the Statute of Limitations has not run.

In explaining this remark he pointed out that if he were a Government investigator assigned to unravel all facets of the assassination of President Kennedy, he would first concern himself with reading the newspaper articles dealing with the topic of a Castro plot. He said he would examine the Castro plot to determine precisely what bearing it had on the assassination of the President. He indicated the newspaper articles had considerable merit and were on the right track in regard to the theory of the assassination.

Without making any factual representations, and continuing to theorize, he went on to relate that his clients, whom he again characterize as respectable citizens, were called upon by a Governmental agency to assist in a project which was said to have the highest Governmental approval. The project had as its purpose the assassination of Fidel Castro, Premier of Cuba. Elaborate plans involving many people were made. These plans included the infiltration of the Cuban Government and the placing of informants in key posts within Cuba. The project almost reached fruition when Castro became aware of it and arrested a number of suspects. By pressuring captured suspects he was able to learn the full details of the plot against him and decided "if that was the way President Kennedy wanted it, he too could engage in the same tactics." Castro thereafter employed teams of individuals who were dispatched to the United States for the purpose of assassinating President Kennedy. ~~Mr. [REDACTED] further~~

[REDACTED]

[REDACTED]

**ASSASSINATION OF PRESIDENT
JOHN FITZGERALD KENNEDY**

explained that his clients (here noting that he, Morgan, was employed by more than one of those involved) obtained information concerning Castro's dispatch of these assassins from "feed back" furnished by sources close to Castro. Continuing, he said his clients were aware of the identity of some of the individuals who came to the United States for this purpose and he understood that two such individuals were now in the State of New Jersey.

Mr. Morgan further noted that one of the clients he represented was a high type individual of the Catholic faith. Morgan said he queried him as to why a person with his high ethical standard had ever become involved in such a project as the assassination of Fidel Castro. The client indicated that his conscience bothered him; however, the project was so highly patriotically motivated that this, in his mind, overrode personal ethical or moral considerations. He further described how one client, when hearing the statement that Lee Harvey Oswald was the sole assassin of President Kennedy, "laughs with tears in his eyes and shakes his head in apparent disagreement."

Mr. Morgan said if he were free of the attorney-client privilege to furnish full details, the information that he would be able to supply would not directly identify the alleged conspirators to kill President Kennedy. However, because of the project to kill Fidel Castro, those participating in the project whom he represents developed through feed back information that would identify Fidel Castro's counter-assassins in this country, who could very well be considered suspects in such a conspiracy. Morgan pointed out that from the information available to him from his clients he could not declare or conclude that Lee Harvey Oswald could not have committed this assassination alone.

Mr. Morgan pointed out that it was inconceivable to him that an agency of the Government which engages in the type of operations which he has described has not come forth to make this most important data available to the Warren Commission. He declined to identify the

[REDACTED]

**ASSASSINATION OF PRESIDENT
JOHN FITZGERALD KENNEDY**

name of the agency but indirectly described it as the investigative agency which conducts intelligence-type investigations outside the United States.

In conclusion, Mr. Morgan reiterated that he would immediately contact the Federal Bureau of Investigation if he discovered any way to reveal the full details of this matter.

In connection with the above it may be of interest to note that during 1961, an investigation was conducted concerning a violation of the Unauthorized Publication or Use of Communications Statute on the part of Arthur James Balletti, who had been arrested by local authorities in Las Vegas, Nevada, on a wire tapping charge. During the course of the Balletti investigation it was ascertained that Robert A. Maheu, a private detective, was involved. Maheu claimed he placed wire taps in behalf of CIA's efforts to obtain intelligence information in Cuba through the hoodlum element, including Sam Giancana. Maheu said he was placed in contact with Giancana in connection with these intelligence activities through John Troselli, a Los Angeles hoodlum.

A representative of the CIA stated he personally contacted Maheu during the Fall of 1960 for the purpose of using Maheu as a "cutout" in contacts with Sam Giancana in connection with CIA's clandestine efforts against Castro.

On May 9, 1962, former Attorney General Kennedy advised that a few days prior thereto he had been advised by CIA that Robert A. Maheu had been hired by CIA to approach Sam Giancana with a proposition of paying \$150,000 to hire some gunmen to go into Cuba and kill Castro. He further stated CIA admitted having assisted Maheu in making the "bugging" installation in Las Vegas (referred to above) which uncovered this clandestine operation and for this reason CIA could not afford to have any action taken against Giancana or Maheu. Mr. Kennedy stated that upon learning CIA had not cleared its action in hiring Maheu and Giancana with the Department of Justice he issued orders that CIA should never again take such steps without first checking with the Department of Justice.

UNITED STATES GOVERNMENT

Memorandum

Tolson	_____
DeLoach	_____
Mohr	_____
Bishop	_____
Casper	_____
Callahan	_____
Conrad	_____
Felt	_____
Gale	_____
Rosen	_____
Sullivan	_____
Tavel	_____
Trotter	_____
Tele. Room	_____
Holmes	_____
Gandy	_____

Mr. DeLoach *DL*

DATE: May 15, 1967

FROM: A. Rosen

- 1 - Mr. DeLoach
- 1 - Mr. Rosen
- 1 - Mr. Malley
- 1 - Mr. Shroder
- 1 - Mr. Wick
- 1 - Mr. Gale
- 1 - Mr. Sullivan
- 1 - Mr. Raupach

SUBJECT: EDWARD REID,
AKA, ED REID
INFORMATION CONCERNING

Ed Reid, a former newspaperman from Las Vegas, who has written several books concerning the hoodlum element and in the past has been described as an irresponsible newspaperman guilty of dishonest reporting, contacted an Agent of our Los Angeles Office.

Initial contact was telephonically made on 5/6/67 at which time Reid indicated he had information concerning John Roselli. On 5/9/67, our Los Angeles Agent met Reid at which time Reid displayed a rough draft manuscript of his new book "Jungle U.S.A.," described as a history and study of organized crime. Reid refers to Carlos Marcello and indicated there was a meeting on 9/11/63 at Churchill Farms, outside New Orleans, Louisiana, attended by several people including Marcello and Reid's informant. Marcello was alleged to have said that in order to get Bobby Kennedy they would have to get the President, and they could not kill Bobby because the President would use the Army and the Marines to get them. The result of killing the President would cause Bobby to lose his power as Attorney General because of the new President. Reid reported in his book that a person who attended this alleged meeting was interviewed by Agents of our Los Angeles Office and furnished them the information. Reid described his informant as reliable, and after leaving New Orleans, his informant traveled to Dallas and Los Angeles and several days later was interviewed concerning the Billie Sol Estes case, at which time he allegedly related to our Agents what he heard at Churchill Farms. Reid said his informant identified our Agents as Jim Ethridge and L. Blanton.

Based on this information, Los Angeles reviewed files concerning the Billie Sol Estes case which revealed that James E. Ethridge and Lanford L. Blanton interviewed Edward Nicholas Becker 11/26/62. In this interview, Marcello was mentioned, and other interviews contained no reference to Marcello. Therefore, it appeared that Becker is Reid's informant. In Becker's interview, Marcello was mentioned in connection with a business proposition

5/15/67

Jones to Wick

REC-61
6/2/67
GWS

5589

NOT RECORDED
CONTINUED - OVER

Memo Rosen to DeLoach
RE: EDWARD REID

and no mention was made of the Attorney General nor were other interviews conducted by these two Agents regarding this matter.

Agents who interviewed Reid told him that information regarding the Churchill Farms conversation was not received as he alleged. At this time, Reid refused to confirm or deny that Becker was his informant. It is noted Reid's informant indicated this information was received on 9/11/63; however, Becker's interview was conducted on 11/26/62, several months preceding. It is noted Edward Nicholas Becker is a private investigator in Los Angeles who in the past has had a reputation of being unreliable and known to misrepresent facts.

Reid declared although the FBI stated this information was not received from his informant, he intends to leave his story as it appears in his book as the book is now in the hands of his publisher.

In connection with John Roselli, Reid wanted to trade information concerning him which offer was refused. He mentioned he was concerned with Roselli's association with Attorney Edward Morgan of Washington, D. C. As you recall, Morgan was previously interviewed at the request of the White House concerning alleged information in his possession regarding the assassination. Also, Roselli was the connecting link between CIA and Robert Maheu who was hired by the CIA to approach Sam Giancana to have Castro assassinated. Roselli is also a member of the Chicago family of La Cosa Nostra who represents Chicago's interests on the West Coast and primarily in Las Vegas.

Carlos Marcello is a leading New Orleans hoodlum who was prosecuted in Federal Court for Fraud Against the Government - Conspiracy in connection with attempt to secure fraudulent birth records in Guatemala and was found not guilty 11/22/63.

The above information is set forth due to the fact the inaccurate information furnished by Reid will appear in a forthcoming publication.

ACTION:

For information.

*Make check discreetly
identify the
Guatemala
R*

JRM

KRM

AS

FEDERAL BUREAU OF INVESTIGATION
FREEDOM OF INFORMATION/PRIVACY ACTS SECTION

SUBJECT: FIDEL CASTRO

FILE NUMBER: 139-1201 CROSS-REFERENCES

UNITED STATES GOVERNMENT

Memorandum

TO : Mr. Belmont

DATE: February 2, 1962

FROM : A. Rosen

SUBJECT: ARTHUR JAMES BALLETTI, Et al.
UNAUTHORIZED PUBLICATION OR USE
OF COMMUNICATIONS

~~TOP SECRET~~

- Tolson
- Belmont
- Mohr
- Callahan
- Conrad
- DeLoach
- Evans
- Malone
- Rosen
- Sullivan
- Tavel
- Trotter
- Tele. Room
- Ingram
- Gandy

~~TOP SECRET~~

This case involves a wire tap placed on the telephone of Dan Rowan of the comedy team of Rowan and Martin by Arthur James Balletti and J. W. Harrison. Balletti was employed by Edward DuBois, a former Bureau Agent who runs a private investigating agency in Miami, Florida. Balletti admits to having been assigned to surveil Rowan in Las Vegas, Nevada, and was accompanied by J. W. Harrison, not further known to him who was supplied by Robert Maheu, another former Bureau Agent. Dan Rowan was reportedly engaged to Phyllis McGuire of the McGuire Sisters trio, who was also reportedly a girl friend of Sam Giancana. Giancana is under investigation by the Chicago Office as a top hoodlum.

Maheu claimed that he ordered coverage of Rowan in behalf of Central Intelligence Agency's (CIA) efforts to obtain intelligence information in Cuba through the hoodlum element, including Sam Giancana, which had interest there. Maheu said he was put in contact with Giancana in connection with these intelligence activities through John Roselli, a Los Angeles top hoodlum. Maheu authorized wiring of Rowan's room and discussed this matter with John Roselli. (u)

Colonel John Sheffield Edwards, Director of Security, CIA, on 5/3/61 advised that Maheu was used as an intermediary with Sam Giancana, relative to CIA's anti-Castro activities. Colonel Edwards said that since this was "dirty business," CIA could not be knowledgeable of Maheu's techniques and therefore had no information as to whether a telephone tap was authorized.

CURRENT DEVELOPMENTS

The Department, by memorandum dated 1/31/62, has requested that we reinterview Colonel Edwards to determine whether the CIA would object to the institution of a criminal prosecution in which Robert Maheu might be a defendant. (u)

- 1- Mr. Evans
- 1- Liaison Section

JWH:mc
(8)

Classified by 6049
 Exempt from GDS by 2
 Date of Declassification Indefinite
 12/17/92

~~TOP SECRET~~ REC 91-1221-1

CIA #16 Dec 6/52 per John E. Bacon 8/27/80

DECLASSIFIED BY SP4-jm/kop ON 3/11/81 FOIA # 22, 330

Brown
Rosen

Memorandum to Mr. Belmont
Re: ARTHUR JAMES BALLETTI

ACTION

It is recommended that the Liaison Agent with CIA reinterview Colonel Edwards in accordance with the Department's request.

[Handwritten signatures and initials: "JWB", "CWB", "R. J. ...", "Yes.", "D.", "V. ..."]

ADDENDUM 2-8-62 (SJK:ban):

On February 7, 1962, Colonel Edwards advised the Liaison Agent that his agency would object to any prosecution which would necessitate the use of CIA personnel or CIA information. He pointed out that an introduction of any evidence concerning the CIA operation would be most embarrassing to the U. S. Government.

~~TOP SECRET~~

UNITED STATES GOVERNMENT

Memorandum

Tolson	_____
Belmont	_____
Mohr	_____
Callahan	_____
Conrad	_____
DeLoach	_____
Evans	_____
Malme	_____
Rosen	_____
Sullivan	_____
Tavel	_____
Trotter	_____
Tele. Room	_____
Holmes	_____
Gandy	_____

TO : MR. SULLIVAN

DATE: April 13, 1962

FROM : D. J. BRENNAN

SUBJECT: ARTHUR JAMES BALLETTI, ET. AL.
UNAUTHORIZED PUBLICATION OR USE
OF COMMUNICATIONS

~~CONFIDENTIAL~~

Reference is made to my memorandum dated April 5, 1962, advising that Central Intelligence Agency (CIA) was opposed to prosecution of Robert Maheu since such action could lead to exposure of most sensitive information relating to the Cuban invasion of April, 1961, and could result in damaging embarrassment to the U. S. Government. (u)

For your information, Colonel Sheffield Edwards, Director of Security, CIA, advised that his Agency was giving serious consideration to conferring with the Department of Justice concerning this matter. It is Edwards' understanding that if this is done contact will be made with the Attorney General or Mr. Herbert J. Miller, Jr., of the Criminal Division.

ACTION:

The above information is being directed to the attention of the General Investigative Division.

SJP:ban
(7)

- 1 - Mr. Belmont
- 1 - Mr. Sullivan
- 1 - Mr. Rosen
- 1 - Mr. McGowan
- 1 - Liaison
- 1 - Mr. Papich

Classified by 6094
Exempt from GDS, Category 2
Spec. De-classification Authority

DECLASSIFIED BY SP4-Jmk/ka
ON 3/10/81
CIA Info declassified per
John E. Bacon 8/27/80

~~CONFIDENTIAL~~

ST-104

REC-9 139-1271-57

APR 18 1962

FEDERAL BUREAU OF INVESTIGATION
FREEDOM OF INFORMATION/PRIVACY ACTS SECTION

SUBJECT: FIDEL CASTRO

FILE NUMBER: 62-116395 CROSS-REFERENCES

UNITED STATES GOVERNMENT

Memorandum

TO: D: K. William O'Connor
Special Counsel for Intelligence
Coordination

FROM: JK: John C. Keeney
Acting Assistant Attorney General
Criminal Division

SUBJECT: Summaries of File #82-46-5

DATE: JUL 1 1975

JCK:mez

In response to your memorandum of June 30, 1975, in this matter, there is attached the requested summary of File Number 82-46-5. Also attached is a xerox copy of the May 14, 1962 memorandum from Sheffield Edwards of the CIA to the Attorney General.

While the attached file summary is more detailed and specific than we would ordinarily submit in response to a request of a Chairman of a Congressional Committee, nonetheless, in view of the background and previous access of the Committee representatives to this file, the more extended summary may be appropriate. We have not submitted the summary to the FBI, and I believe this should be done before it is sent to the Committee.

* CIA Info unclassified per
John E. Bacon 8/27/80

TOP SECRET MATERIAL ATTACHED

ALL INFORMATION CONTAINED
HEREIN IS UNCLASSIFIED 707 pgs #22,330
DATE 3/10/81 BY SP4 Jpm/Ksa

* DOJ Info unclassified per E. Ross Buckley 3/2/81

ENCLOSURE
Attachments



REC-107

62-116375-354

3 JUL 16 1975

[Signature]
LEGAL COUNSEL



Buy U.S. Savings Bonds Regularly on the Payroll Savings Plan

Nevada
SUBJECTS: Sam Giancana, Robert Maheu, Edward L. Dubois, Jr.,
Arthur James Balletti and Unknown Subject, aka
J. W. Harrison
Conspiracy to Violate Title 47, U.S.C. §605
(Wiretapping)

The following consists of a summary of the Bureau's investigation and the results of their investigation into the wiretapping of Dan Rowan's phone in his hotel room at the Riviera Hotel, Las Vegas, Nevada, in October 1960.

The Bureau's initial investigative report dated November 10,

1960, reflects the results of an interview with [REDACTED]

b7C
[REDACTED] Clark County Sheriff's Office on November 1, 1960, involving the arrest of Arthur Balletti on October 31, 1960 for bugging the telephone box in Dan Rowan's hotel room. A search of Balletti's hotel room reflected notes and notations which Balletti had written down dates and times on which he had recorded portions of Rowan's telephone conversations. A black suitcase in Balletti's room was opened and it contained a large quantity of electronic devices, including transmitters, receivers, wall plugs, a minifon wire recorder and a set of 17 professional-type lock picks. On his arrival at the Clark County Sheriff's Office, Balletti admitted that he had been hired by Investigations Incorporated of Miami, Florida, a company owned by former FBI Agent Edward DuBois, and that this company apparently had a client who had requested an investigation concerning Rowan's private life. Balletti admitted listening to and recording Rowan's telephone conversations since October 26, 1960. According to Balletti, one Fred T. Harris, an investigator from Miami, had entered Rowan's room and installed the listening device.

*DECLASSIFIED BY SP4 JML/lee
ON 3/10/81 BY [REDACTED] # [REDACTED]
CIA Info Declassified Per
John E. Bacon 8/27/00*

This document consists of 28 pages No 1 of 2 copies

b7C

In the course of questioning by [redacted] Dan Rowan

advised that within an hour of discussing the wiretapping of his phone with Phyllis McGuire of the McGuire Sisters.

[redacted]

b7C

1960, referred to if Sam Giancana, the Chicago hoodlum, who was known to have of the Detective Bureau, Clark County Sheriff's Office kept company with Phyllis McGuire in the recent past might November 1, 1960 have wanted to know what conversations Rowan and McGuire were October 31, 1960 having. Rowan replied, "How do you know about that?" and stated, "You certainly could have the answer." On November 1,

notes and 1960, Rowan appeared at the Clark County Sheriff's Office and signed a release, stating that he desired that all charges against Balletti be dropped and that no action be taken by the Clark County Sheriff's Office with regard to the burglary and the intrusion of privacy by use of a listening device, stating that Balletti was only working for someone else.

Request for Investigation

By memorandum dated December 5, 1960, the Criminal Division requested the Federal Bureau of Investigation to conduct a full investigation, noting that the facts set forth in the report referred to above indicated a violation of the provisions of 47 U.S.C. §605, and a conspiracy by Arthur James Balletti, Fred T. Harris, and possibly Investigations, Inc., Edward DuBois and others.

Results of Bureau Investigation Conducted
at Criminal Division Request

By a report dated December 23, 1960, at Miami, captioned, "Arthur James Balletti; J. W. Harrison Unauthorized Publication and Use of Communications," a Special Agent of the Bureau advised that Edward L. DuBois, Jr., was interviewed on December 13, 1960, in Miami, Florida, at which time he stated that he had handled certain matters for a Robert Maheu, who operates a private investigation organization in Washington, D.C. DuBois stated that on October 25, 1960, he received a telephone call from Maheu's principal assistant, one Walter Fitzpatrick, requesting him to send two men to Las Vegas, Nevada right away for physical surveillance work. Maheu subsequently instructed DuBois to send only one man to Las Vegas and advised DuBois that he had hired one J. W. Harrison to accompany whomever DuBois sent. DuBois advised that he sent Balletti to Las Vegas on October 26, 1960. DuBois next heard from Balletti when Balletti phoned stating that he had been arrested in Las Vegas as a result of a wiretap and DuBois added that Balletti had been hired strictly for a physical surveillance.

The above-mentioned report dated December 23, 1960, reflects that on December 13, 1960, Arthur James Balletti was interviewed in Miami, concerning his activities in Las Vegas, Nevada. Balletti stated that he would discuss his activities with great reluctance and that it was very probable that he would refuse to answer many questions. Balletti advised that on October 26, 1960 he had flown from Miami, Florida to Las Vegas on a physical surveillance assignment on the orders of his employer, Edward L. DuBois, and that it was his understanding that he was actually working for some other private

investigator who had requested the assistance of DuBois. According to Balletti, at the Miami International Airport he met an individual he identified as J. W. Harrison from a description previously given him and they flew together to Las Vegas. Balletti advised that while in Las Vegas he physically surveilled Dan Rowan and that Harrison apparently put some sort of wiretap in Rowan's room there and monitored Rowan's phone conversations and that he, Balletti, had nothing to do with the tap, did not see it installed and never did any monitoring. Balletti denied that he was accompanied to Las Vegas by one Fred T. Harris, stating that Harrison had used a ticket in the name of Harris and, for this reason, the police in Las Vegas apparently assumed Harrison was Harris. According to Balletti, Harrison left Las Vegas before Balletti was arrested on October 31, 1960. Balletti said he could not comment upon the electronic equipment found in his room.

An FBI investigative report dated December 22, 1960, at Los Angeles, reflects that on December 21, 1960, Dan Rowan furnished a signed statement to special agents of the Bureau at Los Angeles, California. According to Rowan, after originally signing a complaint against Balletti, he discussed the phone tapping incident with Harvey Silbert and Elias Atoll, members of the corporation which operates the Riviera Hotel and he, Rowan, decided that pressing charges against Balletti would inconvenience him. On November 1, 1960 at the Sheriff's Office, Rowan signed a release and dropped charges against Balletti. Rowan advised that he

~~TOP SECRET~~

- 5 -

did not give
/anyone authority to record telephone calls or to install
listening devices in his Room No. 228 or No. 226 at the
Riviera Hotel.

A Bureau investigative report dated December 30, 1960
at Salt Lake City reflects that on December 20, 1960, Lt.
Carl Smith advised that Balletti had been charged with in-
vasion of privacy, a felony; possession of burglary tools,
a misdemeanor; and operating as a private detective without
a license, a misdemeanor, with a preliminary hearing set
for April 24, 1961 in Justice of the Peace Court, Las Vegas.

The manager of Trans World Airlines, Las Vegas, advised
that company records reflect that one, F. T. Harris departed
Las Vegas on Trans World Airlines Flight No. 292 at 10:30 a.m.,
on October 30, 1960, to St. Louis, Missouri, where he made
connections with Trans World Airlines Flight No. 76 to Miami,
Florida.

On December 22, 1960, the desk clerk at the Riviera Hotel
was contacted and shown nine photographs, including one of
Fred T. Harris. The desk clerk advised that he could not
identify anyone whose photo had been exhibited as being identical
with the individual who checked into the Hotel on October 26,
1960 under the name of J. W. Harrison. The desk clerk added
that he did not think he would recognize either Balletti or
Harrison if he should see them in person.

b2 On December 21, 1960, at Las Vegas, Nevada, [REDACTED]
[REDACTED] Clark County Sheriff's Office, furnished a list of
articles in Balletti's possession at the time of his arrest.

~~TOP SECRET~~

These included a telephone bug transmitter recovered from behind the bed in Room 228 at the Riviera Hotel; 17 lock picks; 2 telephone bug devices; one ear phone; one cigarette case containing a miniature transmitter; one Minox camera; one Minox film and other electronic and physical devices, equipment and tools, all enumerated on three typed pages of the foregoing investigative report dated December 30, 1960.

The hotel manager of the Riviera Hotel advised that hotel records reflect that from October 27 to November 5, 1960, ~~Rowan made 15 long distance calls to Edgebrook, Nevada,~~ and that most of the calls had ~~apparently been made to~~ Phyllis McGuire.

The hotel manager also advised on December 21, 1960 at Las Vegas, Nevada, that according to hotel records, Arthur J. Balletti checked into the hotel on October 26, 1960 and was assigned Room 331 and that the registration card bears the notation, "in room with Harrison". Since Balletti's hotel bill was in excess of \$100 and he was not known, the manager and the chief of security for the hotel went to Room 331 and no one was in the room when they entered. At this time, they observed a yellow pad with the notation of time and a date which referred to ~~Dan Rowan~~ and the hotel manager observed in the top desk drawer what appeared to be a recording device. After discussing the bill with Balletti and receiving a somewhat uncertain identification, the hotel manager subsequently notified the Clark County Sheriff's Office that he had observed what appeared to be a recording device in Balletti's room and suspected that a listening device might be installed in Rowan's room. The hotel manager and Deputy Sheriff Eversole

and another Deputy, name unrecalled, entered Rowan's room and the hotel manager observed what appeared to be some type of microphone taped to the rear headboard on the bed in Rowan's room with wires running to the telephone wall box. The hotel manager observed the Deputy Sheriff remove the article from the headboard.

This matter was discussed with Assistant United States Attorney Raymond Sutton on December 22, 1960, and he advised Special Agents of the Bureau that he desired to have the results of a full investigation prior to rendering a prosecutive opinion. Mr. Sutton stated that upon the receipt of results of full investigation he would, in all probability, present the matter to the next federal grand jury which meets in Las Vegas.

By letter dated January 19, 1964, the Assistant Attorney General of the Criminal Division advised the United States Attorney at Reno, Nevada, Mr. Howard W. Babcock, attention: Mr. Raymond Sutton, that the United States Attorney furnish the Criminal Division with his prosecutive opinion upon completion of the investigation and that he not institute criminal prosecution without our prior authorization, unless time is of the essence.

According to a Bureau report dated December 12, 1961, at Washington, D. C., Robert Maheu of Maheu and King Associates, Inc., Washington, D. C., advised on December 27, 1960 that he had received a call from a Los Angeles attorney asking Maheu to recommend someone to do investigative work in Las Vegas,

Nevada for a client. Maheu stated that he recommended Edward DuBois and that the Los Angeles attorney requested him to contact DuBois to make the necessary arrangements to handle the investigation in Las Vegas. Maheu stated that he could not recall if he or Walter Fitzpatrick, an associate of Maheu, had contacted DuBois regarding this request. He stated that his firm was not involved in this matter and that DuBois had been contacted only as a favor to the Los Angeles attorney.

Maheu denied that he had made a second call to DuBois instructing him to send only one man to Las Vegas, adding that he does not know any J. W. Harrison and is not acquainted with Arthur James Balletti. Maheu advised that he did not desire to furnish the identity of the Los Angeles attorney who originally contacted him without the attorney's consent.

By letter dated January 27, 1961, Mr. Howard Babcock advised the Criminal Division that prior to any presentment that office would be furnished with a prosecutive opinion and noted that the Bureau investigation in this matter has not yet been completed.

An FBI investigative report dated February 8, 1961, at Salt Lake City, reflects that efforts to identify unknown subject, J. W. Harrison, have been unsuccessful.

The above report dated February 8, 1961 also reflects that on January 2, 1961, at New York City, Phyllis McGuire advised that she had not given authority to anyone to install a listening device on Dan Rowan at any time and had no prior knowledge that such a device had been used before the arrest of Arthur James Balletti.

~~TOP SECRET~~

- 9 -

The above report also reflects that Thomas Foley, Attorney-at-Law, advised on February 6, 1961, at Las Vegas, Nevada, that during the latter part of October 1960, he received a telephone call from James P. Cantillion, a Los Angeles attorney, requesting Foley to represent Arthur J. Balletti who had been arrested by the Clark County Sheriff's Office. Foley asked Cantillion about payment of the legal fee and Cantillion stated that he would personally guarantee its payment. Foley stated that he immediately contacted a bail bondsman and arranged bond for Balletti. Foley stated that he was of the opinion that James P. Cantillion is the son of father and son team, Cantillion and Cantillion, a law firm in Los Angeles, California. Foley advised that Balletti's trial on the local charge was set for April, 1961.

A Bureau investigative report dated January 28, 1961 at Miami, Florida, reflects that Fred T. Harris advised on January 24, 1961 that although he formerly worked as a private investigator for Investigations, Inc., from June 1960 until November 16, 1960, he did not work for Edward L. DuBois. However, since November 16, 1960, he has been back with DuBois almost full time. Harris stated he definitely did not accompany Balletti to Las Vegas and knew nothing of this affair and while he could not pinpoint his complete activities, he was certain that he was never out of Miami during the period from October 26 through 30, 1960. Harris also stated that he knew nothing of electronic devices and never had any sound training and would have no idea as how to install any/wiretap.
sort of

~~TOP SECRET~~

~~TOP SECRET~~

- 10 -

The same report reflects that Edward DuBois was interviewed on January 24, 1961, at Miami, Florida, stating again that Maheu had informed him that he could only send one man to Las Vegas, that he gave two round-trip tickets to Balletti who went to the Airport, met Maheu's man and travelled to Las Vegas. DuBois stated that Fred Harris definitely did not accompany Balletti to Las Vegas and did not work for him from June until the middle of November, 1960. DuBois stated he had no idea who had hired Maheu and that he had received \$1,000 from Maheu for Balletti's services in Las Vegas. When he, DuBois, learned of Balletti's arrest, he contacted Maheu in Los Angeles and Maheu knew of Balletti's arrest and arranged for a Los Angeles attorney to defend him. Maheu indicated he had made these arrangements through a Los Angeles attorney whose identity he did not disclose.

According to the above-mentioned report, dated January 28, 1961, at Miami, Florida, the desk clerk of the Kenilworth Hotel advised, on January 25, 1961, that registration records reflect that Robert A. Maheu of Washington, D. C., was registered in Room 722 from October 11-29, 1960 and that he was accompanied by one J. A. Rollins, also of Washington, D. C., who stayed in Room 701 from October 11-30, 1960. It was the desk clerk's recollection that Maheu paid the bill, for both of the rooms and she noted that it was possible that either Rollins or Maheu could have left the hotel for a few days and return and if the room was not given up, such information would not be reflected on the registration card.

~~TOP SECRET~~

~~TOP SECRET~~

- 11 -

A Bureau investigative report dated February 14, 1961, at Miami, Florida, reflects numerous long distance phone calls of Robert Maheu made in October 1960 from the Kenilworth Hotel and four such calls made by J.A. Rollins during October 1960.

A Bureau investigative report dated March 6, 1961, at Los Angeles, California, reflects the telephone listing for the Los Angeles number called by DuBois immediately after Balletti's arrest and the telephone listing for Los Angeles numbers called by Maheu and J.A. Rollins from Miami Beach in October 1960. In addition, the report reflects that James P. Cantillion, attorney, Los Angeles, California, advised on March 1, 1961, that his first knowledge of the microphone incident in Las Vegas, Nevada, came from a telephone call to him from a man in custody at Las Vegas whose name he could not recall. When given the name Balletti, Cantillion acknowledged that the name was probably correct but stated that he had no knowledge of Balletti prior to the call which came from a Lieutenant either from the Clarke County's Sheriff's Office or the Las Vegas City Jail. He claimed privilege for his conversation with Balletti but advised that he referred the caller to attorney Tom Foley in Las Vegas. Cantillion stated that he knew Robert Maheu. Cantillion denied telephoning or otherwise contacting Maheu in Washington, D. C., or elsewhere, to ask him to perform surveillance on Dan Rowan.

A Bureau memorandum dated March 13, 1961, at Los Angeles, California, reflects information concerning James P. Cantillion, including that one John Roselli stayed at the Beverly Hilton Hotel when he came to Los Angeles and he visits with an attorney,

~~TOP SECRET~~

James Cantillion of Beverly Hills, California. Records of the Los Angeles, California Police Department reflect that John Roselli, FBI # 3339986, was first arrested by the Los Angeles Police Department in 1924 for carrying concealed weapons, but the charge was dismissed. During the period from 1924 to 1932, he was arrested on several occasions on charges of suspicion of grand larceny, carrying concealed weapons and robbery. In testimony before the Kefauver Committee in October 1950, Roselli advised that he met Al Capone in Chicago and that he spent a day with Capone in Los Angeles, California, in about 1930. Records of the United States District Court indicate that on December 22, 1943, Roselli was found guilty of violation of Section 402A, Title 18, U.S.C., and sentenced to 10 years imprisonment. The charge involved extorting money from motion picture producers to insure the studios against labor strikes.

The above report reflects that Cantillion was apparently involved in business transactions with Roselli and had been visited by Roselli and one Louis J. Lederer, a close friend of Roselli and apparently linked to nationally-known hoodlum and gambler, Frank Costello, of New York. Cantillion, Lederer and Roselli were, according to the report, all involved in hotels and gambling operations in Las Vegas, Nevada.

A Bureau investigative report dated March 27, 1961, at Washington, D. C. reflects that on January 19 and January 30, 1961, Robert Maheu was interviewed and remained unable to supply the name of the Los Angeles attorney who had originally contacted him and requested him to contact Edward DuBois.

Maheu advised that he had stayed at the Kenilworth Hotel in Miami Beach during the latter part of October 1960, but denied that he had instructed DuBois to send only one man to Las Vegas and stated that his only involvement in the matter was to have DuBois contacted at the request of the Los Angeles attorney. Maheu identified the J.A. Rollins who was with him at the Kenilworth Hotel as John A. Rollins and would not identify him further, stating Rollins was working indirectly for him in Miami. Maheu denied that Rollins was the individual who went to Las Vegas to assist Balletti. Shortly after the interview, Mr. Maheu telephonically contacted a Special Agent of the Bureau at the Washington Field Office, stating that "he had just received a telephone call and if this matter could be held up for a few days, it would be all straightened out."

A Bureau report dated April 6, 1961, at Miami, Florida, reflects that Balletti was interviewed on March 29, 1961 at which time he denied ownership of the technical equipment confiscated in his hotel room aside from a tape recorder and cameras. Balletti stated that he did not recall telling the arresting officers at Las Vegas that J. W. Harrison was actually Fred Harris of Miami. Balletti stated that on October 30 or 31, 1960, he received a long distance telephone call from Robert Maheu who instructed him to contact T. W. Richardson at the New Frontier Hotel. Maheu advised Balletti

that Richardson would pay him \$1,000 and that when Balletti contacted Richardson giving a password, Richardson gave him 10 one hundred dollar bills in a men's room. Balletti again denied that he knew the true identity of J. W. Harrison.

The same report reflects that on March 20, 1961, DuBois advised that Robert Maheu had paid him \$1,000 in cash as his retainer. DuBois claimed that Balletti had told him that on October 31, 1960, he, Balletti, received a long distance telephone call from Maheu who claimed that he was calling from Los Angeles and instructed Balletti to contact a Mr. Richardson and that Richardson would pay him the retainer. DuBois was asked if he knew John A. Rollins and he stated that he did not know anyone by that name. DuBois was questioned regarding the equipment found in Room 331 of the Riviera Hotel at the time Balletti was arrested and DuBois denied that any of the technical equipment aside from the minifon tape recorder and the cameras belonged to his agency. DuBois assumed that the equipment belonged to J. W. Harrison. DuBois reiterated that he did not know the name of the principal in this case who contacted Maheu to have the surveillance conducted on Rowan.

A Bureau report dated April 11, 1961 reflects that a communication from the Washington Field Office dated February 13, 1961, advised that Maheu was still unable to secure permission from the attorney to divulge the attorney's name to the FBI. Maheu denied that Rollins was the individual who went to Las Vegas with Balletti, stating that the Kenilworth Hotel records

in Miami would reflect that Rollins was there during the period Balletti was in Las Vegas.

This report reflects that by communication dated March 28, 1961, the Riviera Hotel registration card, which contained the handwriting of the unknown subject, also known as J. W. Harrison, was submitted to the FBI Laboratory to be compared with the handwriting on the registration card from the Kenilworth Hotel at Miami Beach which bears the name J. A. Rollins.

According to a Bureau investigative report dated April 12, 1961 at Los Angeles, California, Dan Rowan telephonically contacted a special agent of the Bureau on April 5, 1961 at which time he advised that he did not believe that he had any information of pertinence to add. Rowan stated that he first heard of Sam Giancana from a ~~██████████~~ with the Clark County Sheriff's Office, Las Vegas, Nevada and stated that he had never met Giancana. Rowan advised that he has discussed Giancana on one or two occasions with Phyllis McGuire, observing that she was hesitant to discuss Giancana and stated that her relationship with him took place long ago and she saw no reason to discuss it. McGuire stated that Giancana still sends her gifts and flowers, but that this is entirely his idea and she has nothing to do with him.

CIA Involvement

A Bureau memorandum dated April 20, 1961 at Washington, D.C., reflects that on April 18, 1961, Maheu advised that following the recent invasion of Cuba by anti-Castro forces

he was now in a position to furnish additional information regarding the situation involving the subjects at Las Vegas, Nevada. At this time, Maheu offered his explanation (set forth in detail in a previous memorandum concerning Central Intelligence Agency involvement in this matter) that Rowan's hotel room was to be the subject of electronic surveillance in connection with determining the source of a leak of information on the part of an individual in the Chicago area. Maheu stated that his work could be verified by "Shef Edwards", Colonel Sheffield Edwards, Director of Security, CIA.

The Director of the Bureau advised the Attorney General by memorandum dated May 22, 1961 that the full investigation requested in this matter is continuing, although the memo noted in view of the information regarding CIA's attempted utilization of the "hoodlum element" in connection with anti-Castro activities, CIA has requested that this information be handled on a "need-to-know" basis. The Bureau also attached to this memorandum the results of an interview on May 3, 1961 with Colonel Sheffield Edwards, Director of Security, Central Intelligence Agency, which has previously been set forth in detail in the memorandum setting forth the CIA's involvement in this matter.

By communication dated April 11, 1961, the FBI Laboratory advised that the handwriting on the Kenilworth Hotel, Miami Beach, registration card and the hand-printed name of J.A. Rollins was not comparable with the handwriting on the Riviera

Hotel, Las Vegas, Nevada, registration card bearing the signature of J.W. Harrison.

On May 13, 1961, records of the Clark County Sheriff's Office reflect that the State charges against Arthur James Balletti were dismissed on April 24, 1961, since the complaining witness did not desire to prosecute.

A Bureau investigative report dated June 6, 1961 at Washington, D. C. reflects that on May 25, 1961, Maheu again advised of his involvement with the Central Intelligence Agency in connection with their attempt to utilize Giancana in connection with the CIA's activities against the Castro government. Maheu stated that the original contact with Giancana was made by "Johnny" who Maheu declined to further identify. Maheu stated that it was his decision to have a microphone coverage installed in Rowan's room and he was extremely careful as he did not want to involve the CIA. Maheu advised that DuBois did not know the CIA's interest in this matter and in requesting DuBois to handle the assignment, he had used a pretext indicating to DuBois that a Los Angeles, California attorney had made the original request for coverage of Rowan. Maheu still denied that he had called one DuBois instructing him to send only/man to Los Angeles and that he, Maheu, would supply the second man. Maheu subsequently advised that he had sent word to Sam Giancana as to the extent of the investigation following his Bureau interview on May 25, 1961.

An FBI report dated June 26, 1961 at Miami, Florida reflects that Edward DuBois and Arthur Balletti, after viewing a photo of John Roselli, said on June 20, 1961 that they did not recognize him and that they have not been in contact with him in connection with their investigation of Rowan at Las Vegas, Nevada. However, one employee of the Kenilworth Hotel advised that she believed the photograph of John Roselli was a photograph of J.A. Rollins, but could not make a positive identification without seeing the man in person. An FBI report dated June 29, 1961, at Las Vegas, Nevada, reflects that on June 17, 1961, the manager of the Riviera Hotel advised that he knows John Roselli by sight and that so far as he knew, Roselli had never stayed at that hotel and he felt sure that Roselli was not the individual who checked into the hotel on October 26, 1960, using the name J.W. Harrison.

According to a Bureau investigative report dated June 30, 1961, at Los Angeles, Robert Maheu advised on June 29, 1961 that the "Johnny" to whom he made contact with Sam Giancana was John Roselli and that he discussed the plan to wire Rowan's room with Roselli before it was done. It was pointed out to Maheu that the explanation he gave in a previous interview for wiring Rowan's room did not appear logical and was far removed from the purpose for which he was hired by the Central Intelligence Agency. Maheu stated that he would stick to the explanation previously given and wished to add that he would never have ordered Rowan's room wired except for his connection with the CIA.

An FBI investigative report dated July 19, 1961, at Chicago, reflects that Samuel M. Giancana was interviewed at O'Hare International Airport, Chicago, on July 12, 1961 by special agents of the Bureau and he refused to make any comment regarding Maheu and refused to admit that he was acquainted with Dan Rowan. In the course of the interview, Giancana became very abusive and obscene. During this time, Miss Phyllis McGuire, who apparently traveled with Giancana, was also interviewed by special agents of the Bureau, although the results of that interview were not reflected. The special agents' conversation with Giancana was terminated upon the appearance of Miss McGuire. Giancana left accompanied by Miss McGuire.

An FBI report dated July 20, 1961 at Los Angeles, California, reflects that Maheu was interviewed on July 15, 1961 and persisted in his story with respect to the bugging of Rowan's hotel room. Maheu denied that the installation of the device in Rowan's room was made at the request or for the benefit of Sam Giancana or John Roselli.

The same report reflects that Roselli was interviewed on July 7, 1961, and admitted that he had known Maheu for approximately 5 years. When asked if he knew Giancana, Roselli stated, "Let's discuss the weather. I do not care to answer any more questions."

On August 2, 1961, United States Attorney Howard W. Babcock, at Las Vegas, Nevada, advised that he is not certain that it could be proven that any information received by Balletti and the unknown subject was ever "disseminated" and also

he was very concerned about the possibility of information becoming known of Robert Maheu performing work for the CIA.

By letter dated October 13, 1961, Mr. Babcock noted that his successor assumes office on October 16, 1961 and, therefore, felt it appropriate that his successor review the file and investigative reports.

In response to a request from the Criminal Division dated January 31, 1962, the Bureau ascertained from the Director of Security of the Central Intelligence Agency, Col. Sheffield Edwards, that his Agency would object to any prosecution which would necessitate the use of CIA personnel or CIA information and that the introduction of any evidence concerning the CIA operation would be most embarrassing to the United States Government. This Bureau reply was dated February 9, 1962.

In response to an additional request from the Criminal Division dated March 19, 1962, the Bureau replied, by memorandum dated April 10, 1962, that Col. Edwards advised that Maheu's prosecution undoubtedly would lead to exposure of most sensitive information relating to the abortive Cuban invasion in April 1961 and in view of this, his Agency objects to the prosecution of Maheu.

By memorandum dated April 24, 1962, Mr. Herbert J. Miller, Jr., Assistant Attorney General, Criminal Division, advised the Attorney General that it is clear that the national interest will preclude any prosecution resulting from the Nevada wiretap case, adding at the conclusion of the memo that prosecutive action will be declined.

1 - Mr. J. B. Adams
1 - Mr. W. V. Cleveland

The Attorney General

September 3, 1975

Director, FBI

2 - Mr. J. A. Mintz
(1 - Mr. J. B. Hotis)
1 - Mr. W. R. Wannall
1 - Mr. W. O. Cregar
1 - Mr. F. J. Cassidy

UNITED STATES SENATE SELECT COMMITTEE ON INTELLIGENCE ACTIVITIES (SSC)

Reference is made to the letter addressed to Mr. Shaheen from the SSC dated August 25, 1975, which requested staff access to "all memoranda written by Special Agent Sam Papich or Special Agent Mel Kurtz concerning contacts between any CIA personnel and (a) Robert Mahu; (b) Sam Giancana; (c) John Roselli; or (d) Santos Trafficante during the period 1960-1963."

Attached for your approval and forwarding to the SSC is the original of a memorandum which responds to the request contained in the above-mentioned SSC letter.

A copy of the memorandum is also being furnished for your records.

Enclosures - 2

62-116395

1 - The Deputy Attorney General
Attention: Michael E. Shaheen, Jr.
Special Counsel for
Intelligence Coordination

REC-20

62-116395-712

EX 103

SEP 19 1975

DELIVERED TO COMMITTEE 9-3-75

Jan/81

*CIA Info unclassified per John E. Brown 8/27/80
ALL INFORMATION CONTAINED HEREIN IS UNCLASSIFIED
DATE 3/10/81 BY SP4 Jm/Kaa

- Assoc. Dir. _____
- Dep. AD Adm. _____
- Dep. AD Inv. _____
- Asst. Dir.:
- Admin. _____
- Comp. Syst. _____
- Ext. Affairs _____
- Files & Com. _____
- Gen. Inv. _____
- Ident. _____
- Inspection _____
- Intell. _____
- Laboratory _____
- Plan. & Eval. _____
- Spec. Inv. _____
- Training _____
- Legal Coun. _____
- Telephone Rm. _____
- Director Sec'y _____

NOTE:

We have previously disseminated information to the SSC concerning information developed re CIA involvement with the hoodlum element as it concerns efforts to assassinate Fidel Castro. We first became aware of such CIA involvement in connection with our investigation of an Unauthorized Publication or Use of Communications case involving one Arthur James Balletti

NOTE CONTINUED - PAGE 2

MAIL ROOM TELETYPE UNIT

84 SEP 22 1975

The Attorney General

NOTE CONTINUED:

in 1961. Prior to that investigation, we had developed information through a source that Sam Giancana was involved in an operation to assassinate Fidel Castro; however, that information did not concern involvement with any Government agency. Information developed in connection with the Balletti case surfaced CIA's involvement with Robert Maheu, Sam Giancana, and John Roselli, the latter two being hoodlums. We promptly disseminated this information to the Attorney General. All pertinent material has been made available to the SSC; however, they continue to seek underlying material on which our dissemination was based. One of the SSC investigators recently interviewed former SA Papich who indicated to the investigator he had dictated a number of memoranda concerning CIA's involvement with hoodlums. Apparently, based on that interview, the SSC has now made this additional request. Extensive file reviews of all individuals mentioned in the SSC request have been made and a number of memoranda dictated by Papich have been found. None of these memoranda shed any additional light on assassination attempts against Castro. They do show, however, continuing contact between representatives of the CIA and John Roselli during the period we were mounting an operation against Roselli. They further show that CIA officials did not consider attempting to interfere with our operations or prosecution of Roselli. Section Chief R. J. McCarthy, Criminal Intelligence and Organized Crime Section, Special Investigative Division, has advised that the Special Investigative Division interposes no objection to making the documents available for review by the SSC.

- 1 - Mr. J. B. Adams
- 1 - Mr. W. V. Cleveland
- 2 - Mr. J. A. Mintz
(1 - Mr. J. B. Hotis)
- 1 - Mr. W. R. Wannall

September 3, 1975

- 1 - Mr. W. O. Cregar
- 1 - Mr. F. J. Cassidy

**U. S. SENATE SELECT COMMITTEE TO
STUDY GOVERNMENTAL OPERATIONS WITH
RESPECT TO INTELLIGENCE ACTIVITIES (SSC)**

**RE: REQUEST FOR STAFF ACCESS TO
UNDERLYING MATERIALS LOGICALLY
RELATED TO INFORMATION IN FBI
FILES CONCERNING ASSASSINATION
ATTEMPTS AGAINST FIDEL CASTRO
IN WHICH THE CENTRAL INTELLIGENCE AGENCY
WAS INVOLVED**

ALL INFORMATION CONTAINED
 HEREIN IS UNCLASSIFIED
 DATE 3/10/81 BY SP4-Jmi/Kan
 CIA Info unlessified
 Per John E. Bacon 8/27/80

Reference is made to the letter to Michael E. Shaheen, Jr., Special Counsel for Intelligence Coordination, Office of the Deputy Attorney General, U. S. Department of Justice, dated August 25, 1975, from John T. Elliff, Director, Domestic Intelligence Task Force, of captioned Committee.

Referenced letter requested Committee access to "all memoranda written by Special Agent Sam Papich or Special Agent Mef Kurtz concerning contacts between any CIA personnel and (a) Robert Mabeu; (b) Sam Giancana; (c) John Roselli; or (d) Santos Trafficante during the period 1960-1963."

The "Mef Kurtz" mentioned above is identical with former Special Agent Maffert W. Kuhrtz, who retired from the FBI on November 21, 1962.

For your information, Mr. Kuhrtz served on the Domestic Liaison staff of the FBI until May 29, 1961, when he was transferred to the Inspection Division of the FBI. From November 16, 1961, until January 4, 1962, he was temporarily assigned to the FBI Domestic Liaison staff to handle duties of former Special Agent Sam Papich, who was on a special assignment.

- Assoc. Dir. _____
- Dep. AD Adm. _____
- Dep. AD Inv. _____
- Asst. Dir.:
- Admin. _____
- Comp. Syst. _____
- Ext. Affairs _____
- Files & Com. _____
- Gen. Inv. _____
- Ident. _____
- Inspection _____
- Intell. _____
- Laboratory _____
- Plan. & Eval. _____
- Spec. Inv. _____
- Training _____
- Legal Coun. _____
- Telephone Rm. _____
- Director Sec'y _____

Extensive file reviews, including our complete holdings on Mabeu, Giancana, Roselli, and Trafficante, as well as our holdings on anti-Castro activities, have again been made and the only memorandum written by Mr. Kuhrtz concerning the subject matter of interest is the memorandum

FJC:glw
(10)

Handwritten initials and signatures:
 SA [initials] wra/hal
 [signature]
 wop [signature]

Senate Select Committee on Intelligence Activities (SSC)

Re: Request for Staff Access to Underlying Materials Logically Related to Information in FBI Files Concerning Assassination Attempts Against Fidel Castro in which the Central Intelligence Agency Was Involved

dated May 4, 1961, captioned "Arthur James Balletti, et al., Unauthorized Publication or Use of Communications," which reported his interview of Colonel Sheffield Edwards, then Director of Security of the Central Intelligence Agency (CIA), on May 3, 1961. Staff access to this document was provided to Messrs. Epstein and Postal on August 20, 1975.

With regard to memoranda written by Mr. Papich concerning the subject matter of interest during the period 1960-1963, extensive file review has located the following documents: u

Addendum to a memorandum dated February 2, 1962, captioned "Arthur James Balletti, et al., Unauthorized Publication or Use of Communications," which reported a Papich contact of Colonel Sheffield Edwards on February 7, 1962, at Department of Justice instruction, to determine if CIA would object to the institution of a criminal prosecution in which Robert Maheu might be a defendant. Messrs. Epstein and Postal reviewed this document on August 20, 1975.

Memorandum dated April 5, 1962, captioned "Arthur James Balletti, et al., Unauthorized Publication or Use of Communications," which reported a contact of Colonel Edwards by Papich on April 2, 1962, at the request of the Department of Justice. This memorandum was reviewed by Messrs. Epstein and Postal on August 20, 1975.

Memorandum dated April 13, 1962, captioned "Arthur James Balletti, et al., Unauthorized Publication or Use of Communications," which reported that Colonel Edwards advised Papich that CIA was giving serious consideration to conferring with the Department of Justice concerning possible proposed prosecutive action by the Department against Robert Maheu and the resultant damaging embarrassment such action could cause the U. S. Government. Mr. Edwards indicated it was his understanding that if such contact was made it would be with the Attorney General or Mr. Herbert J. Miller, Jr., Assistant Attorney General, Criminal Division of the Department.

Senate Select Committee on Intelligence Activities (SSC)

**Re: Request for Staff Access to Underlying Materials Logically
Related to Information in FBI Files Concerning Assassination
Attempts Against Fidel Castro in which the Central Intelligence Agency
Was Involved**

Memorandum dated June 21, 1968, which reported a Papich interview of William Harvey, a CIA employee, charged with closing out the relationship between CIA and John Roselli. According to Harvey he had met with Roselli on June 20, 1968, for that purpose.

The pertinent portions of this interview were reported in our dissemination to the Attorney General, dated March 6, 1967, captioned "Central Intelligence Agency's Intentions to Send Hoodlums to Cuba to Assassinate Castro."

A copy of the above-mentioned communication has been provided to your Committee. u

Extensive file review has located a number of documents which, while not in the time frame of your request, do have a bearing on the subject of interest. These memoranda were prepared by Mr. Papich between the years 1966-1968 and for the most part concern contacts between John Roselli and William Harvey. Harvey was charged with winding up the relationship between Roselli and CIA. One memorandum, dated June 3, 1968, concerns advice from CIA that that Agency had terminated its working arrangement with Robert Mabeu.

The above-mentioned documents are available for review in Room 4171, J. Edgar Hoover Building, by appropriate personnel of the Committee staff. ~

1 - The Attorney General

5-140 (Rev. 1-21-74) FEDERAL BUREAU OF INVESTIGATION
WASHINGTON, D. C. 20535

Addressee: Senate Select Committee

LTR LHM Memo Report dated 9/3/75

Caption of Document: Req for Staff access to underlying materials logically related to info in FBI files concerning assassination attempts against Castro in which CIA was involved.

Originating Office: FBI

Delivered by: Mr. Schwarz Date: 9/5/75

Received by: Maitha Talley

Title: Research

Return this receipt to the Intelligence Division, FBI

ALL INFORMATION CONTAINED
HEREIN IS UNCLASSIFIED *FOIA #22,330*
DATE 3/10/81 BY SP4-jpm/ka
*CIA info unclassified per
John E. Bacon 8/27/80*

TO: Intelligence Community Staff ATTN: Central Index		FROM: FBI	
SUBJECT: Abstract of Information Provided to Select Committees			
1. HOW PROVIDED (check appropriate term. If a document was made available for review but not transmitted, so note.)			2. DATE PROVIDED
<input checked="" type="checkbox"/>	DOCUMENT	<input type="checkbox"/>	BRIEFING
<input type="checkbox"/>		<input type="checkbox"/>	INTERVIEW
<input type="checkbox"/>		<input type="checkbox"/>	TESTIMONY
<input type="checkbox"/>		<input type="checkbox"/>	OTHER
			9/3/75
FOR REVIEW			
3. TO WHOM PROVIDED (check appropriate term; add specific names if appropriate)			
<input checked="" type="checkbox"/>	SSC	ALL INFORMATION CONTAINED HEREIN IS UNCLASSIFIED <i>70199#22,330</i> *CIA info unclassified per DATE <u>3/10/81</u> BY <u>SP4-gym/k20</u> JOHN E. Bacon 8/27/80	
<input type="checkbox"/>	HSC		
4. IDENTIFICATION (provide descriptive data for documents; give name or identification number of briefer, interviewee, testifier and subject)			
Memorandum			
5. IN RESPONSE TO (list date and item number if in response to formal request, otherwise state verbal request of (name), initiative, subpoena, etc.)			6. CLASSIFICATION OF INFORMATION (enter U, C, S, TS or Codeword)
SSC letter 8/25/75			U
7. KEY WORDS (enter the appropriate key words from the list provided separately; if key words not listed are used underline for emphasis)			
Intelligence activities, domestic			
8. SUMMARY (see reverse side before completing this item)			
<p>Made available to appropriate personnel of the SSC Staff for review at FBIHQ, memorandum prepared by Sam Papich between years 1966-68 and for the most part concerns contacts between John Roselli and William Harvey. Harvey was charged with winding up the relationship between Roselli and CIA. One memorandum 6/3/66 concerning advice from CIA that that Agency had terminated its working arrangement with Robert Mahou.</p> <p>62-116395 FMK: fak (4) ORIGINAL VIA LIAISON TO CENTRAL COMMUNITY INDEX IN CONNECTION WITH SENSTUDY 75</p> <p style="text-align: right;">AS YELLOW <i>5- WOC</i></p>			

INSTRUCTIONS

- Type or print clearly in ink.
- Indicate classification of the abstract top and bottom.
- Date the abstract and put on any internal control numbers required.
- "FROM" entry should clearly identify the organization providing the information.
- If additions (as when a copy of document sent to SSC is later sent to HSC) or changes to a previously submitted form are necessary, submit a copy of the original abstract, with the change indicated.

SPECIFIC ITEM NO. 8. SUMMARY - enter brief narrative statement describing substance of information and showing relationship to Intelligence Community matters if appropriate. Any feedback or evidence of investigatory interests should be noted. Commitments made to supply additional information should be noted. Additionally, certain administrative information may be entered here, e.g., restrictions on review of a document, if document was paraphrased, whether interviewee is current or former employee, etc. If actual document or transcript is provided, that fact should be noted and no summary is required. Additional pages may be attached if necessary.

1 - Mr. J. B. Adams
1 - Mr. W. V. Cleveland

The Attorney General

September 16, 1975

Director, FBI
SI 117-100-61

62-116395-798

2 - Mr. J. A. Mintz
(1 - Mr. J. B. Hotis)
1 - Mr. W. R. Wannall
1 - Mr. W. O. Cregar
1 - Mr. F. J. Cassidy

U. S. SENATE SELECT COMMITTEE ON
INTELLIGENCE ACTIVITIES (SSC)

Reference is made to the letter to the Attorney General from Senator John Tower, Vice Chairman, SSC, which enclosed two letters from John T. Elliff, Director, Domestic Intelligence Task Force, SSC, both dated September 11, 1975. One of these letters contained 26 requests, the second 8 requests, all of which requests relate to SSC interest in CIA involvement with the hoodlum element in connection with plans to assassinate Fidel Castro.

With regard to Item 6 in the letter containing eight requests, we believe that the document requested is in the Department's Giancana correspondence file, as we have no such file designated as such, nor could we locate such a document in our files. Further, we feel the Phil White referred to in the request was connected with the Department.

Enclosed is a memorandum for your approval and forwarding to the Committee in response to the above-mentioned letters of September 11, 1975.

Also enclosed for your records is a copy of the memorandum prepared for the Committee.

Enclosures - 2

62-116395

ENCLOSURE

ALL INFORMATION CONTAINED
HEREIN IS UNCLASSIFIED
DATE 3/11/81 BY SP4 Jmm/klc
CIA Info unclassified per
John E. Bacon 8/27/80

- Assoc. Dir. _____
- Dep. AD Adm. _____
- Dep. AD Inv. _____
- Asst. Dir.:
- Admin. _____
- Comp. Syst. _____
- Ext. Affairs _____
- Files & Com. _____
- Gen. Inv. _____
- Ident. _____
- Inspection _____
- Intell. _____
- Laboratory _____
- Plan. & Eval. _____
- Spec. Inv. _____
- Training _____
- Legal Coun. _____
- Telephone Rm. _____

1 - The Deputy Attorney General
Attention: Michael E. Shaheen, Jr.
Special Counsel for
Intelligence Coordination

SEE NOTE PAGE 2

FJC:glw
(11)

84 OCT 14 1975

MAIL ROOM TELETYPE UNIT

GPO

The Attorney General

NOTE:

The SSC requests were directed to the Attorney General by letter from Senator Tower, Vice Chairman, SSC, who asked that the furnishing of the material requested be afforded the highest priority. In forwarding the request, the Department has requested that the material be made available by 9/16/75. The requests, copies of which are attached, deal mainly with communications concerning John Rosselli and Sam Giancana, top hoodlums who were utilized by CIA through a cutout in efforts to assassinate Fidel Castro. The FBI has promptly disseminated any and all information received concerning this subject at the time of its occurrence specifically to then Attorney General Robert Kennedy and the Committee has been so advised. It appears that the majority members of the Committee are attempting to prove that the Kennedys were unaware of the CIA assassination plot while the minority members are attempting to prove otherwise. As the majority of the information being requested by the Committee concerns the hoodlum element, the documents being furnished have been reviewed by representatives of the Special Investigative Division and they interpose no objection to the transmission of these documents to the Committee.

WTS

- 1 - Mr. J. B. Adams
- 1 - Mr. W. V. Cleveland
- 2 - Mr. J. A. Mintz
(1 - Mr. J. B. Hotis)
- 1 - Mr. W. R. Wannall

September 16, 1975

- 1 - Mr. W. O. Cregar
- 1 - Mr. F. J. Cas

**U. S. SENATE SELECT COMMITTEE TO
STUDY GOVERNMENTAL OPERATIONS WITH
RESPECT TO INTELLIGENCE ACTIVITIES (SSC)**

Reference is made to the two letters, both dated September 11, 1975, to Michael E. Shaheen, Special Counsel for Intelligence Coordination.

The letter containing 26 requests will hereinafter be referred to as request #1. The second letter containing 8 requests will be referred to as request #2.

The materials requested in the above-mentioned letters have been processed and will be delivered to the Committee on September 16, 1975, with this communication.

It is noted that Item 6, request #1, and Item 5, request #2, are identical requests.

With regard to Item 5 of request #1 which refers to an "FBI Report of November 11, 1962 re: Crime Conditions in Los Angeles," we can find no such report; however, we have located such a report dated November 15, 1962. Please advise if that is the report of interest to you.

With regard to Item 10 of request #1 identified as an FBI memorandum of February 6, 1962, from Rosen to Belmont, your letter states that Mr. Postal of your staff had previously reviewed this memorandum. The memorandum which Mr. Postal reviewed was dated February 2, 1962. A copy of this memorandum is being furnished.

With regard to Item 12 of request #1 identified as an FBI report of October 10, 1961, contained in Bureau file 92-3267, we can locate no such report in that file; however, we did locate a report in that file dated October 16, 1961, a copy of which is being furnished.

* CIA Info unclassified Per John E. Bacon 8/6/75
 ALL INFORMATION CONTAINED HEREIN IS UNCLASSIFIED DATE 3/11/81 BY SP4-SJK/STW

- Assoc. Dir. _____
- Dep. AD Adm. _____
- Dep. AD Inv. _____
- Asst. Dir.:
- Adm. _____
- Comp. Syst. _____
- Ext. Affairs _____
- Files & Com. _____
- Gen. Inv. _____
- Ident. _____
- Inspection _____
- Intell. _____
- Laboratory _____
- Plan. & Eval. _____
- Spec. Inv. _____
- Training _____
- Legal Coun. _____
- Telephone Rm. _____
- Director Sec'y _____

FJC:glw
(10)

62-118395-79
 JBA
 PM
 WRS
 WRS

MAIL ROOM TELETYPE UNIT

ENCLOSURE

This document is prepared in response to your request and is not for dissemination.

U. S. Senate Select Committee On Intelligence Activities (SSC)

b7C
05
With regard to Item 24 of request #1, our indices contain no references to a [REDACTED]. One reference concerning a [REDACTED] and one reference to a [REDACTED] were located. A Xerox copy of each of these indices cards is being furnished. \

b7C
With regard to Item 25 of request #1 which requested advice as to whether there is any information contained in the John Rosselli electronic surveillance logs concerning 18 individuals or situations, a check of our electronic surveillance indices revealed references to three of the individuals; namely, Sam Giancana, [REDACTED] and Robert Mabeu, as having been overheard through electronic surveillance coverage on John Rosselli. Without further advice as to the identity of "any White House person" or "any DOJ person" no logical search of electronic surveillance indices can be made. \

With regard to Item 26 of request #1 in which you requested to be advised if six individuals had been the subject of electronic surveillance, our files reveal that two of the six named were the subjects of such coverage; namely, Sam Giancana and Santos Trafficante. \

In view of the fact that some of the information contained in the material being furnished originates from sensitive FBI sources in the criminal field and because of privacy considerations of individuals referred to in this material, it is requested that access be restricted to those persons having an absolute need to know. \

1 - The Attorney General

SEP 12 1975

TO: Richard L. Thornburgh
Assistant Attorney General
Criminal Division

John A. Mintz, Assistant Director
Legal Counsel Division
Federal Bureau of Investigation

FROM: Michael E. Shaheen, Jr.
Special Counsel for Intelligence
Coordination

SUBJECT: Senate Select Committee Requests

Attached for your attention and priority response are two letters from the Senate Select Committee.

One letter makes 26 numbered requests. Requests numbered 11, 19 thru 23, invite Criminal Division response. All other requests seek Bureau response. (I have also attached a letter from Senator Tower to the Attorney General in which he asks that the Attorney General assign these requests the highest priority.)

The second letter contains 8 numbered requests, all of which are addressed to the Bureau. (You will note they involve the same area of inquiry as those for which Senator Tower requests priority treatment.)

Please arrange for the prompt preparation of responses.

8/24/75 H.G.
9/10/75 FJC:glw
(Encls-2)
LHM:JSC
9/10/75 FJC:glw

23 Encls
ENCLOSURE

ENCL BEHIND FILE

cc: Paul Daly

REC-61

ST. 114

OCT 2 1975

LEGAL COUNSEL

FIVE

Rec'd 9:25 AM
9/15/75
FJC

5-140 (Rev. 1-21-74) FEDERAL BUREAU OF INVESTIGATION
WASHINGTON, D. C. 20535

Addressee: Senate Select Committee

LTR LHM Memo Report dated 9/16/75

Caption of Document: Re two letters both dated 9/11/75.
Contained 26 requests & 8 requests relating to
CIA involvement with hoodlum element in con-
nection with plans assassinate Castro.

Originating Office: FBI

Delivered by: Paul Kelly Date: 9/16/75

Received by: Lynsey Carter

Title: Click

Return this receipt to the Intelligence Division, FBI

ALL INFORMATION CONTAINED
HEREIN IS UNCLASSIFIED ^{FOIA} # 22,330
DATE 3/11/81 BY SP4-jm/ken
*CIA Info unclassified per
John E. Bacon 8/27/80

TO: Intelligence Community Staff
ATTN: Central Index

FROM: **FBI**

SUBJECT: Abstract of Information Provided to Select Committees

1. HOW PROVIDED (check appropriate term. If a document was made available for review but not transmitted, so note.)
 DOCUMENT BRIEFING INTERVIEW TESTIMONY OTHER

2. DATE PROVIDED
9/16/75

3. TO WHOM PROVIDED (check appropriate term; add specific names if appropriate)
 SSC
 HSC

CIA info unclassified per John E. Bacon 8/27/80
ALL INFORMATION CONTAINED HEREIN IS UNCLASSIFIED
DATE 3/11/81 BY SP4 GJM/KZA

4. IDENTIFICATION (provide descriptive data for documents; give name or identification number of briefer, interviewee, testifier and subject)
Memorandum and enclosures

5. IN RESPONSE TO (list date and item number if in response to formal request, otherwise state verbal request of (name), initiative, subpoena, etc.)
SSC letter 9/11/75

6. CLASSIFICATION INFORMATION (U, C, S, TS or Codeword)
U

7. KEY WORDS (enter the appropriate key words from the list provided separately; if key words not listed used underline for emphasis)
Surveillance, electronic

8. SUMMARY (see reverse side before completing this item)
Information furnished relates to communications concerning John Rosselli and Sam Giancana, top hoodlums utilized by CIA in efforts to assassinate Fidel Castro.
62-116395
FMK:lhb (4)
ORIGINAL VIA LIAISON TO CENTRAL COMMUNITY INDEX IN CONNECTION WITH SENSSTUDY 75
TREAT AS YELLOW

INSTRUCTIONS

- Type or print clearly in ink.
- Indicate classification of the abstract top and bottom.
- Date the abstract and put on any internal control numbers required.
- "FROM" entry should clearly identify the organization providing the information.
- If additions (as when a copy of document sent to SSC is later sent to HSC) or changes to a previously submitted form are necessary, submit a copy of the original abstract, with the change indicated.

SPECIFIC ITEM NO. 8. SUMMARY - enter brief narrative statement describing substance of information and showing relationship to Intelligence Community matters if appropriate. Any feedback or evidence of investigatory interest should be noted. Commitments made to supply additional information should be noted. Additionally, certain administrative information may be entered here e.g., restrictions on review of a document, if document was paraphrased, whether interviewee is current or former employee, etc. If actual document or transcript is provided, that fact should be noted and no summary is required. Additional pages may be attached if necessary.

CLASSIFY AS APPROPRIATE

SEE INSTRUCTIONS ON REVERSE BEFORE COMPLETING.

TO: Intelligence Community Staff
ATTN: Central Index

FROM:
FBI

SUBJECT: Abstract of Information Provided to Select Committees

1. HOW PROVIDED (check appropriate term. If a document was made available for review but not transmitted, so note.)

2. DATE PROVIDED
9/15/75

DOCUMENT	BRIEFING	<input checked="" type="checkbox"/> X	INTERVIEW	TESTIMONY	OTHER
----------	----------	---------------------------------------	-----------	-----------	-------

3. TO WHOM PROVIDED (check appropriate term; add specific names if appropriate)

The Attorney General with copy for forwarding to the White House

SSC

HSC

4. IDENTIFICATION (provide descriptive data for documents; give name or identification number of briefer, interviewee, testifier and subject)

Memorandum reporting results of an interview by SSC Staff Member of incumbent SA Fred J. Cassidy

5. IN RESPONSE TO (list date and item number if in response to formal request, otherwise state verbal request of (name), initiative, subpoena, etc.)

NA

6. CLASSIFICATION OF INFORMATION (enter U, C, S, TS or Codeword)

U

7. KEY WORDS (enter the appropriate key words from the list provided separately; if key words not listed use underline for emphasis)

Liaison
Intelligence Collection

ALL INFORMATION CONTAINED
HEREIN IS UNCLASSIFIED 704422,330
DATE 3/11/81 BY SP4-Jmm/Kex

8. SUMMARY (see reverse side before completing this item)

Concerning FBI's knowledge of, and participation in, the so-called "Huston Plan."

62-116395

FMK:lhb
(4)

ORIGINAL VIA LIAISON TO CENTRAL COMMUNITY INDEX
IN CONNECTION WITH SENSTUDY 75

TREAT AS YELLOW

INSTRUCTIONS

- Type or print clearly in ink.
- Indicate classification of the abstract top and bottom.
- Date the abstract and put on any internal control numbers required.
- "FROM" entry should clearly identify the organization providing the information.
- If additions (as when a copy of document sent to SSC is later sent to HSC) or changes to a previously submitted form are necessary, submit a copy of the original abstract, with the change indicated.

SPECIFIC ITEM NO. 8. SUMMARY - enter brief narrative statement describing substance of information and showing relationship to Intelligence Community matters if appropriate. Any feedback or evidence of investigatory interest should be noted. Commitments made to supply additional information should be noted. Additionally, certain administrative information may be entered e.g., restrictions on review of a document, if document was paraphrased, interviewee is current or former employee, etc. If actual document or transcript is provided, that fact should be noted and no summary is required. Additional pages may be attached if necessary.

FRANK CHURCH, IDAHO, CHAIRMAN
JOHN G. TOWER, TEXAS, VICE CHAIRMAN
PHILIP A. HART, MICH.
WALTER F. MONDALC, MINN.
WALTER D. HUDSON, KY.
ROBERT MORGAN, N.C.
GARY HART, COLO.
HOWARD H. BAKER, JR., TENN.
BARRY GOLDWATER, ARIZ.
CHARLES MCC. MATHEWS, JR., MD.
RICHARD S. SCHWEIKER, PA.
WILLIAM G. MILLER, STAFF DIRECTOR

United States Senate

SELECT COMMITTEE TO
STUDY GOVERNMENTAL OPERATIONS WITH
RESPECT TO INTELLIGENCE ACTIVITIES
(PURSUANT TO S. RES. 21, 94TH CONGRESS)
WASHINGTON, D.C. 20510

September 11, 1975

SENSITIVE

Honorable Edward H. Levi
Attorney General
Department of Justice
Washington, D. C. 20530

Dear Mr. Attorney General:

You are doubtless aware of the fact that this Committee is completing its work on an interim report on the assassination question. Evidence relating to critical aspects to the report have recently come to the attention of our staff. It appears that certain documentary and other evidence in the possession of your Department has direct and material bearing upon our ability to fully explore these new matters.

In consultation with the Chairman, it has been determined that these matters should be assigned the highest priority. Accordingly, it is requested that you provide such assistance as may be appropriate to facilitate production of the materials called for by the attached document request which has been transmitted to Mr. Michael E. Shaheen, Jr., your Special Counsel for Intelligence Coordination. It is anticipated that witnesses having information relative to these new matters under investigation will be interviewed as early as Tuesday of the coming week.

While it is with the greatest reluctance that the Committee must request this further burdening of your resources, it is hoped that the specificity of this request will expedite compliance.

Your continuing cooperation in support of our mandate is greatly appreciated.

Sincerely,

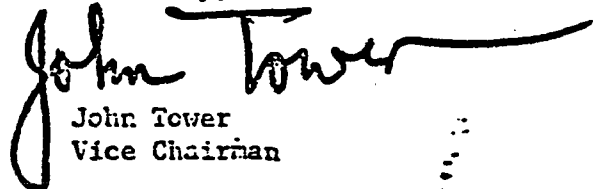
John Tower
Vice Chairman



FRANK CHURCH, IDAHO, CHAIRMAN
 JOHN G. TOWER, TEXAS, VICE CHAIRMAN
 PHILIP A. HART, MINN.
 WALTER F. MONDALE, MINN.
 WALTER D. MIDDLETON, KY.
 ROBERT MORGAN, N.C.
 GARY HART, COLO.
 HOWARD H. BAKER, JR., TENN.
 BARRY GOLDWATER, ARIZ.
 CHARLES MCC. MATHIAS, JR., MD.
 RICHARD S. SCHWEIKER, PA.
 WILLIAM G. MILLER, STAFF DIRECTOR

United States Senate

SELECT COMMITTEE TO
 STUDY GOVERNMENTAL OPERATIONS WITH
 RESPECT TO INTELLIGENCE ACTIVITIES

(PURSUANT TO S. RES. 21, 94TH CONGRESS)

WASHINGTON, D.C. 20510

September 11, 1975

SENSITIVE

Michael E. Shaheen, Jr., Esquire
 Special Counsel for Intelligence
 Coordination
 Office of the Deputy Attorney General
 U. S. Department of Justice
 Washington, D. C. 20530

Dear Mr. Shaheen:

The following list of documents and materials contained in the FBI and Justice Department files are hereby requested by the Senate Select Committee on Government Operations with Respect to Intelligence Activities:

- ① Memorandum of February 27, 1962 from Director, FBI to Attorney General re: John Rosselli.
- ② FBI Report of January 3, 1962 contained in Bureau file #92-3171.
- ③ Memorandum of January 12, 1962 from Director, FBI to Attorney General re: Nevada Gambling Industry.
- ④ FBI Report of October 17, 1962 contained in Bureau file #92-3267.
- ⑤ FBI Report of November 11, 1962 re: Crime Conditions in Los Angeles contained in field file #94-250 Los Angeles.
- ⑥ Memorandum of July 9, 1963 from Director, FBI to Attorney General re: Samuel Giancana.
- ⑦ FBI Report of July 15, 1963 contained in Bureau file #92-3267.

*4 copies to Mr. Shaheen
 5 or 2 per request
 EY*



Michael E. Shaheen, Jr., Esquire
Page two
September 11, 1975

SENSITIVE

⑧ FBI Report of August 5, 1963 contained in Bureau file #92-3171.

Items 9 and 10 are contained in documents previously made available for inspection by A. Postal.

⑨ FBI Memorandum of April 5, 1968 from Brennan to Sullivan.

⑩ FBI Memorandum of February 6, 1962 from Rosen to Belmont.

Post
⑪ Letter from Department of Army, Security Division, received April 3, 1962, and contained in the Samuel Giancana correspondence file, in Organized Crime and Racketeering Section, Criminal Division.

⑫ FBI Report of October 10, 1961 contained in Bureau file #92-3267.

⑬ FBI Report of November 22, 1961 contained in Bureau file #92-3267.

⑭ FBI Report of August 4, 1961 contained in Bureau file #92-3267.

⑮ Memorandum of March 7, 1961 from Director, FBI to Attorney General in abovementioned Giancana correspondence file.

⑯ Memorandum of May 18, 1961 from Director, FBI to Attorney General.

⑰ Letter to Attorney General from Director, FBI of December 11, 1961, re: Giancana or Rosselli.

⑱ Letter from Director, FBI to Attorney General of November 24, 1961, re: Giancana or Rosselli.

⑲ FBI Report of January 28, 1961 contained in DOJ file #82-46-5.

⑳ FBI Report of July 18, 1961 contained in DOJ file #82-46-5.

Dept
㉑ Memorandum re: AUSA in Las Vegas of August 16, 1961, and contained in DOJ file #82-46-5.

㉒ Note of October 6, 1961 contained in DOJ file #82-46-5.

SENSITIVE

Michael E. Shaheen, Jr., Esquire
Page three
September 11, 1975

Sept

23. Access to Criminal Division file #71-4-16-27 re: anti-Castro activities.

24. Xerox copies of name index cards, and subject of each file identified on:

b7C
OS
[Redacted] - N.R.

25. The Committee wishes to be advised whether there is any information contained in the John Rosselli electronic surveillance logs concerning:

*Wire calling
LA + LV to
send in logs
OS b7C
b7D*

- a. Castro
- b. CIA
- c. Judy Campbell
- d. Robert Maheu
- e. [Redacted]
- f. Balletti Wiretap Case
- g. [Redacted]
- h. Bill Harvey
- i. Sheffield Edwards
- j. Samuel Giancana
- k. Santos Trafficante
- l. [Redacted]
- m. [Redacted]
- n. [Redacted]
- o. [Redacted]
- p. Balletti
- q. any White House person
- r. any DOJ person

b7D OS
b7C OS
11-5-61

b7C OS

26. The Committee wishes to be advised whether there was any electronic surveillance on Judy Campbell, [Redacted] Samuel Giancana, Robert Maheu, [Redacted] or Santos Trafficante.

b7C OS

Sincerely,

John T. Elliff

John T. Elliff
Director
Domestic Intelligence Task Force

*copy of the
Kennedy's
Evelyn Link*

FRANK CHURCH, IDAHO, CHAIRMAN
 JOHN G. TOWER, TEXAS, VICE CHAIRMAN
 PHILIP A. HART, MICH. HOWARD H. BAKER, JR., TENN.
 WALTER F. MONDALE, MINN. BARRY GOLDWATER, ARIZ.
 WALTER D. MIDDLETON, KY. CHARLES MCC. MATHIAS, JR., MD.
 ROBERT MORGAN, N.C. RICHARD S. SCHWEIKER, PA.
 GARY HART, COLO.
 WILLIAM G. MILLER, STAFF DIRECTOR

United States Senate

SELECT COMMITTEE TO
 STUDY GOVERNMENTAL OPERATIONS WITH
 RESPECT TO INTELLIGENCE ACTIVITIES

(PURSUANT TO S. RES. 21, 94TH CONGRESS)

WASHINGTON, D.C. 20510

September 11, 1975

Michael E. Shaheen, Jr., Esquire
 Special Counsel for Intelligence
 Coordination
 Office of the Deputy Attorney General
 U. S. Department of Justice
 Washington, D. C. 20530

Dear Mr. Shaheen:

The following list of documents and materials contained in the FBI and Justice Department files are hereby requested by the Senate Select Committee on Government Operations with Respect to Intelligence Activities:

- ① FBI Memorandum of November 1, 1967 from Brennan to Sullivan.
- ② FBI Memorandum of May 8, 1967 from Brennan to Sullivan.
- ③ FBI Memorandum of June 21, 1963 from Brennan to Sullivan.
- ④ FBI Report of March 10, 1962 contained in Bureau file #92-3267.
- ⑤ Letter of July 9, 1963 from Director, FBI to Attorney General, contained in abovementioned Giancana correspondence file.
- ⑥ Letter from Robert Plummer to Phil White of February 6, 1962, contained in abovementioned Giancana correspondence file.
- ⑦ Memorandum of July 14, 1961 from Director, FBI to Attorney General, re: Giancana or Rosselli.

*Send on to 6
on 11/10/75*

*PA unit Dept file?
tell Dept*

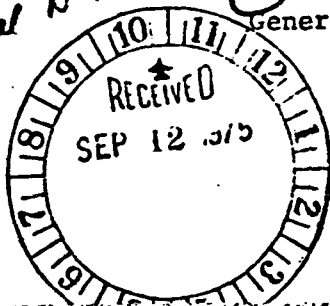

Michael E. Shaheen, Jr., Esquire

Page two

September 11, 1975

⑧ Memorandum of July 26, 1961 from Director, FBI to Attorney General, re: Giancana or Rosselli.

Sincerely,

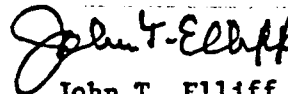

John T. Elliff

Director

Domestic Intelligence Task Force

FEDERAL BUREAU OF INVESTIGATION
FREEDOM OF INFORMATION/PRIVACY ACTS SECTION

SUBJECT: FIDEL CASTRO

FILE NUMBER: 62-80750 CROSS-REFERENCES

CLASS. & EXT. BY *out for [unclear]*
REASON-FCIM II, 1-2.4.2
DATE OF REVIEW *7/2/85*

UNITED STATES

Memorandum

~~SECRET~~

*CIA info classified
per let of John E. Bacon
9/27/80*

- Tolson
- Belmont
- Mohr
- DeLoach
- Casper
- Callahan
- Conrad
- Felt
- Gale
- Rosen
- Sullivan
- Tavel
- Trotter
- Tele. Room
- Holmes
- Gandy

TO : Mr. W. C. Sullivan

DATE: 7/2/65 1 - Liaison

FROM : Mr. D. J. Brennan, Jr. *DJB*

- 1 - Mr. Sullivan
- 1 - Mr. Branigan
- 1 - Mr. R. W. Smith
- 1 - Mr. Wannall
- 1 - Mr. Cotter
- 1 - Personnel File of Robert Mah
- 67-172006
- 1 - Mr. Papich

SUBJECT: CENTRAL INTELLIGENCE AGENCY (CIA)
ROBERT A. MAHEU ASSOCIATES *215*

[REDACTED]

[REDACTED]

[REDACTED]

[REDACTED]

Maheu is a former Bureau Agent who entered on duty in 1940 and resigned in 1947. For several years he has been operating a private investigative agency which has included the handling of public relations business. The Bureau has been most circumspect in its dealings with Maheu since 1953.

In 1961, he was a possible subject of a case involving a telephone wire tap but he claimed that he had ordered this technical coverage in behalf of CIA efforts to obtain intelligence information in Cuba. We did verify that CIA had utilized Maheu as an intermediary in their operations directed against Castro. In April, 1962, CIA objected to prosecution of Maheu, taking the position that such action might lead to the exposure of sensitive information relating to the abortive Cuban invasion of April, 1961, and would result in damaging embarrassment to the U.S. Government. The Director made the notation at this time "this is an outrage."

ACTION:
ALL INFORMATION CONTAINED HEREIN IS UNCLASSIFIED EXCEPT WHERE SHOWN OTHERWISE
SJP:chs (10)

ST-110

67-8750-4347

Certainly ill-advised

79 JUL 9 - 1965

JUL 8 1965

~~SECRET~~

5. [unclear]

*b1
b3
per
CIA*

*b6
b7c*

~~TOP SECRET~~

- 1 - Mr. DeLoach
- 1 - Mr. Gale
- 1 - Mr. Wick
- 1 - Mr. Sullivan

DECLASSIFIED BY *SP4 Gmm/K*
 ON *3/2/81*
 CIA Info declassified per Let
 of John E. Bacon 8/27/80
 The Attorney General

ROUTE IN ENVELOPE
 TO IPA# 22,330
 Classified by *6049*
12/27/71

March 6, 1967

Director, FBI

Mr. Papich
 Mr. Wannall
 Inspector

**CENTRAL INTELLIGENCE AGENCY'S
 INTENTIONS TO SEND HOODLUMS TO
 CUBA TO ASSASSINATE CASTRO**

I know cc to 62-116391
Wannall to Adams
more 4/8/75

CC to Rockefeller Commission
12 CIA activities (62-116391)
4-24-75
Senate Select Committee

Our files contain the following information concerning the captioned matter, much of which has been furnished by the Central Intelligence Agency (CIA) on a strictly highly confidential "need-to-know" basis. In view of this, it is requested that it be handled on a most restrictive basis. *u*

This matter first came to our attention in the Spring of 1961 in connection with our investigation of a violation of the Unauthorized Publication or Use of Communications Statute on the part of Arthur James Balletti, who had been arrested by local authorities in Las Vegas, Nevada, on a local wire tapping charge. Balletti and another unidentified individual in October, 1960, had reportedly placed a wire tap on the telephone of Dan Rowan, a member of the comedy team of Rowan and Martin. Rowan at the time reportedly was engaged to Phyllis McGuire of the well-known McGuire Sisters singing trio who was also known to be a girl friend of Sam Giancana, a top hoodlum. *u*

During the course of the Balletti investigation it was ascertained that Robert A. Maheu, a private detective, was involved. Maheu during interview claimed he ordered coverage of Rowan in behalf of CIA's efforts to obtain intelligence information in Cuba through the hoodlum element, including Sam Giancana, which had interests there. Maheu said he was put in contact with Giancana in connection with these intelligence activities through John Roselli, a Los Angeles hoodlum. Maheu stated also that he authorized the wiring of Rowan's room and had discussed the matter with Roselli. *u*

The essence of the above was furnished to former Attorney General Robert F. Kennedy by letter dated May 22, 1961, which enclosed a memorandum of the same date containing data made available on May 3, 1961, by Colonel Sheffield Edwards, who at that time was Director of Security at CIA, regarding his utilization of Maheu in connection with anti-Castro activities. Since our files show that Mr. Kennedy returned the original of our letter and its enclosed memorandum dated May 22, 1961.

MAILED 2
 MAR 6 1967
 COMM-FBI

REC-20
 MAR 7 1967
 4553

GCM:ans

SEE NOTE, PAGE 4

MAR 13 1967

MAIL ROOM TELETYPE UNIT

~~TOP SECRET~~

GROUP 1
 Excluded from automatic
 downgrading and
 declassification

own
WAD
slm

The Attorney General

to us for filing purposes, a copy of the May 22, 1961, memorandum is attached hereto for your information. ~~(u)~~

You will note that Colonel Edwards advised he personally contacted Robert Maheu during the Fall of 1960 for the purpose of using Maheu as a "cutout" in contacts with Sam Giancana in connection with CIA's clandestine efforts against Castro. Colonel Edwards stated that Giancana's activities were completely "backstopped" by Maheu, who would frequently report Giancana's actions and information to Edwards. No details or methods used by Maheu or Giancana in accomplishing their missions were reported to him, according to Edwards, as such involved "dirty business," of which Colonel Edwards could not afford to have knowledge. Accordingly, he said he had no prior knowledge of the above-mentioned wire tapping by Balletti. ~~(u)~~

Further with respect to this matter, I was informed of the following on a highly confidential basis by former Attorney General Kennedy during a conference in my office on May 9, 1962:

He indicated that a few days prior thereto he had been advised by CIA that Robert A. Maheu had been hired by CIA to approach Sam Giancana with a proposition of paying \$150,000 to hire some gunmen to go into Cuba and kill Castro. He further stated CIA admitted having assisted Maheu in making the "bugging" installation in Las Vegas (referred to above) which uncovered this clandestine operation and for this reason CIA could not afford to have any action taken against Giancana or Maheu. Mr. Kennedy stated that upon learning CIA had not cleared its action in hiring Maheu and Giancana with the Department of Justice he issued orders that CIA should never again take such steps without first checking with the Department of Justice.

Mr. Kennedy further advised that because of this matter it would be very difficult to initiate any prosecution against Giancana, as Giancana could immediately bring out the fact the United States Government had approached him to arrange for the assassination of Castro. He stated the same was true concerning any action we might take against Maheu for any violation in which he might become involved.

On June 20, 1963, Mr. William Harvey, an official of CIA, advised that he had held a meeting with John Roselli (referred to above as Maheu's link with Giancana) for the purpose of closing out the entire matter with which Roselli had been involved. In this connection, Harvey stated that CIA had

The Attorney General

established contact with Roselli in "early 1961" with respect to a sensitive operation against Castro. Harvey said that for all intents and purposes the operation was discontinued and canceled after the ill-fated Bay of Pigs invasion in April, 1961, but Roselli had not been completely cut off, as he periodically indicated he was in a position to be of assistance.

It appears Roselli has since that time, nevertheless, used his prior connections with CIA to his best advantage. For example, in May, 1966, when contacted by Agents of this Bureau in connection with our current investigation of his activities he refused to talk and immediately flew to Washington, D. C., and consulted with Colonel Sheffield Edwards, who is now retired from CIA. Colonel Edwards in turn advised CIA, which told us. Mr. Howard J. Osborn, the present Director of Security, CIA, freely has admitted to us that Roselli has CIA in an unusually vulnerable position and that he would have no qualms about embarrassing CIA if it served his own interests. In furnishing this information, Mr. Osborn asked that it be held within this Bureau on a strictly need-to-know basis. ~~XS~~(u)

In light of the above information furnished us by CIA and former Attorney General Kennedy, it appears that data which came to our attention in October, 1960, possibly pertains to the captioned matter. At that time a source close to Giancana advised that during a conversation with several friends Giancana stated that Fidel Castro was "to be done away with very shortly." Giancana reportedly assured those present that Castro's assassination would occur in November, 1960, and that he had already met with the assassin-to-be on three occasions, the last meeting having taken place on a boat docked at the Fontainebleau Hotel, Miami Beach, Florida. Reportedly, Giancana claimed that everything had been perfected for the killing and the "assassin" had arranged with a girl, not further described, to drop a "pill" in Castro's drink or food.

Also of possible interest is a news article carried in the August 16, 1963, issue of the "Chicago Sun Times." This article carried the headline, "CIA Bought Giancana's Help For Cuba Spying," and it was reported therein that CIA agents had contacted Giancana in an effort to obtain Cuban intelligence after Castro came into power. u

Enclosure

1 - The Deputy Attorney General (Enclosure)

~~TOP SECRET~~

The Attorney General

NOTE:

See cover memorandum Wannall to Sullivan, same caption,
March 6, 1967, GCM:ams. u

Classified "Top Secret" inasmuch as information contained
herein is so classified by CIA. u

- 4 -

~~TOP SECRET~~

UNITED STATES GOVERNMENT
ROUTE IN ENVELOPE
Memorandum

- Tolson _____
- DeLoach _____
- Mohr _____
- Wick _____
- Casper _____
- Callahan _____
- Conrad _____
- Felt _____
- Gale _____
- Rosen _____
- Sullivan _____
- Tavel _____
- Trotter _____
- Tele. Room _____
- Holmes _____
- Gandy _____

TO : W. C. Sullivan

DATE: March 6, 1967

FROM : W. R. Wannall

- 1 - Mr. Sullivan
- 1 - Mr. Papich
- 1 - Mr. Wannall
- 1 - Inspector

~~TOP SECRET~~

SUBJECT: ~~TOP SECRET~~ CENTRAL INTELLIGENCE AGENCY'S
 INTENTIONS TO SEND HOODLUMS TO
 CUBA TO ASSASSINATE CASTRO
 DECLASSIFIED BY SPY-SEARCH
 ON 3/2/81 FOIPA# 22,330

CIA Info declassified
 per let of John C. Baker
 8/27/80

Jale
Wannall

In accordance with instructions, attached letter has been prepared for Attorney General setting forth all data in our files concerning captioned matter. Briefly, information being furnished is as follows:

Matter first came to our attention in Spring of 1961 in connection with our investigation of violation of Unauthorized Publication or Use of Communications Statute on the part of Arthur James Balletti, arrested in Las Vegas, Nevada, by local authorities on wire tapping charge. Wire tap involved was on telephone of Dan Rowan, member of Rowan and Martin comedy team. Rowan at the time reportedly was engaged to Phyllis McGuire, girl friend of top hoodlum Sam Giancana and member of McGuire Sisters singing trio.

Through our investigation we determined involvement of Robert A. Maheu, private detective, who stated coverage on Rowan instituted in behalf of Central Intelligence Agency (CIA) efforts to obtain Cuban intelligence data through hoodlum element, including Sam Giancana. Maheu was in contact with Giancana through services of John Roselli, another hoodlum, and Maheu authorized wiring of Rowan's room.

We checked matter with CIA on 5/3/61 and learned CIA was utilizing Maheu as intermediary with Sam Giancana relative to CIA's "dirty business" anti-Castro activities. CIA insisted it did not give Maheu any instructions relative to use of technical installations. By letter 5/22/61 we furnished former Attorney General Kennedy a memorandum containing a rundown on CIA's involvement in this. The originals of the letter and memorandum were returned to us for filing purposes. A copy of that memorandum is being attached to instant letter being sent to Attorney General.

On 5/9/62 Kennedy discussed with the Director a number of matters, including admission by CIA that Robert Maheu had been

Enclosure sent 3-6-67

TOP SECRET
 ↓ REC-72 ↓ 62 80750-4557

61 MAR 23 1967

CONTINUED - OVER

6 MAR 13 1967

cc to Rockefeller Commission on CIA
 Attached 4/24/75 (62-116391) FK

139-1201
 UNRECORDED COPY FILED IN

62-116391
 4/8/75

L. T. ...
 7/1/67

Memorandum for Mr. Sullivan
Re: CENTRAL INTELLIGENCE AGENCY'S
INTENTIONS TO SEND HOODLUMS TO
CUBA TO ASSASSINATE CASTRO

hired by that Agency to approach Sam Giancana to have Castro assassinated at a cost of \$150,000. Kennedy stated he had issued orders that CIA should never undertake such steps again without first checking with Department of Justice and stated because of this matter it would be difficult to prosecute Giancana or Maheu then or in the future.

We learned on 6/20/63 from CIA that its contacts with John Roselli (Maheu's link with Giancana) had continued up until that time, when they were reportedly cut off.

It appears Roselli is using his prior connections with CIA to his best advantage. In May, 1966, when Bureau Agents endeavored to interview him he immediately flew to Washington and informed his former CIA intermediary. The current Director of Security, CIA, has advised through liaison channels that Roselli has CIA in an unusually vulnerable position and Roselli would have no qualms about embarrassing CIA to serve his own interests. In furnishing this information we were asked that it be held within this Bureau on a strictly need-to-know basis. We have, however, included it in the attached proposed letter to the Attorney General noting this CIA specific restriction. *AS(u)*

We have two other references in our files to the over-all above information which we have included in the letter. One relates to a statement by Giancana in October, 1960, that he had met with an individual who was to assassinate Castro in November, 1960. The other is an article in the 8/16/63 issue of the "Chicago Sun Times" reporting that CIA agents had contacted Giancana to obtain Cuban intelligence.

ACTION:

If approved, attached letter will be sent to the Attorney General, with a copy for the Deputy Attorney General. U

gen

over

WCS

The Attorney General asked for this information on Friday, 3/3/67.

ps

~~TOP SECRET~~

UNITED STATES GOVERNMENT

Memorandum

- 1 - Mr. W.C. Sullivan
- 1 - Mr. J.H. Gale
- 1 - Mr. T.E. Bishop

- Tolson _____
- Sullivan _____
- Mohr _____
- Bishop _____
- DeLoach _____
- Casper _____
- Callahan _____
- Conrad _____
- Felt _____
- Gale _____
- Rosen _____
- Tavel _____
- Walters _____
- Soyars _____
- Tele. Room _____
- Holmes _____
- Gandy _____

TO : Mr. C. D. Brennan

DATE: 1/18/71

FROM : W. R. Wannall *[Signature]*

- 1 - Mr. C.D. Brennan
- 1 - Mr. W. A. Branigan
- 1 - Mr. W.R. Wannall
- 1 - Mr. Nasca

SUBJECT: ~~CENTRAL INTELLIGENCE AGENCY'S INVOLVEMENT IN ATTEMPTS TO ASSASSINATE CASTRO~~

~~TOP SECRET~~

~~TOP SECRET~~

Memorandum concerns Jack Anderson's column in 1/18/71 "Washington Post," which indicates Central Intelligence Agency (CIA) made six attempts to assassinate Premier Fidel Castro. *u*

Anderson claims CIA's first attempt began as part of Bay of Pigs operation (1961); after it failed sent five more assassination teams to Cuba; and among those privy to CIA conspiracy is suspicion, unsupported by Warren Commission's findings, that Castro became aware of assassination plot and somehow recruited Lee Harvey Oswald to retaliate against President Kennedy. With regard to first attempt, Anderson stated CIA enlisted Robert Maheu, former FBI Agent, who recruited gambler John Roselli to arrange assassination. *u*

CIA's involvement in Castro assassination plan first came to our attention in 1961. At that time, we conducted investigation of violation of Unauthorized Publication or use of Communications Statute by Arthur James Balletti, arrested in Las Vegas, Nevada, by local authorities on wire tapping charge. Our investigation determined this involved Maheu who stated coverage was instituted in behalf of CIA's efforts to obtain Cuban intelligence data through hoodlum element, including Sam Giancana. Maheu was in contact with Giancana through services of John Roselli another hoodlum. *u*

On 5/3/61, CIA advised it was utilizing *u* as intermediary with Giancana relative to CIA's "dirty business" anti-Castro activities. On 5/22/61, we furnished facts to then Attorney General Kennedy. On 5/9/62, Kennedy stated he had issued orders that CIA should never undertake such steps again without first checking with Department of Justice. On 3/6/67, all information in our files concerning this matter was furnished to Attorney General and Deputy Attorney General. *u*

Classified by: 701044 22, 330
DECLASSIFIED BY: SP4-Jgm/1022
ON 3/10/81
*CIA INFO Declassified per John E. Bacon 3/27/80

REC-65 62-80750-4811

VHN:enj
(8) 58

JAN 22 1971

~~TOP SECRET~~

TOP SECRET CONTINUED - OVER

ENCLOSURE

3 XEROX

3002

JAN 22 1971

Exempt from GDS, Category 2, 3 per 62-109060-4984
Date of Declassification Indefinite

5 N...

Memorandum W. R. Wannall to Mr. C. D. Brennan
Re: Central Intelligence Agency's Involvement in
Attempts to Assassinate Castro

~~TOP SECRET~~

In February, 1967, Secret Service advised columnist Drew Pearson contacted former Chief Justice Warren concerning information in possession of Attorney Edward P. Morgan, former Bureau Inspector. Morgan alleged former Attorney General Kennedy organized group to kill Castro. Subsequently, after Castro learned of plot, he decided to utilize same procedure to kill President Kennedy and hired Oswald to do the job. On 3/17/67, White House requested Bureau interview Morgan concerning assassination of President Kennedy.

Morgan was interviewed on 3/20/67. Due to attorney-client relationship, Morgan would not identify persons who furnished information concerning assassination. Morgan alleged his clients were used by a Government Agency (obviously CIA) to plot assassination of Castro and that Castro learned of plot and thereafter dispatched teams of assassins to U. S. to assassinate President Kennedy. He stated that the information attributed to Drew Pearson probably arose as a result of comments Morgan made suggesting that Lee Harvey Oswald "was not the only person involved" in the assassination of President Kennedy. Morgan furnished no information to the effect Castro hired Oswald to assassinate Kennedy and we developed no such information during our extensive investigation of the Kennedy assassination. Results of our interview with Morgan together with the information we previously had concerning CIA's involvement in plot to assassinate Castro, was furnished White House, Attorney General, and Secret Service on 3/22/67.

We have no information concerning the other five CIA alleged assassination plots against Castro.

ACTION:

For information.

W.R.W.
Ozall
W.C.F.
WBS
12/2

~~TOP SECRET~~

~~TOP SECRET~~

- Tolson _____
- Sullivan _____
- Mohr _____
- Bishop _____
- Brennan, C.D. _____
- Callahan _____
- Casper _____
- Conrad _____
- Felt _____
- Gale _____
- Rosen _____

WFO

The Washington Merry-Go-Round THE WASHINGTON POST Monday, Jan. 16, 1971 B7

6 Attempts to Kill Castro Laid to CIA

By Jack Anderson

Locked in the darkest recesses of the Central Intelligence Agency is the story of six assassination attempts against Cuba's Fidel Castro.

For 10 years, only a few key people have known the terrible secret. They have sworn never to talk. Yet we have learned the details from sources whose credentials are beyond question.

We spoke to John McCone, who headed the CIA at the time of the assassination attempts. He acknowledged the idea had been discussed inside the CIA but insisted it had been "rejected immediately." He vigorously denied that the CIA had ever participated in any plot on Castro's life. Asked whether the attempts could have been made with his knowledge, he replied: "It could not have happened."

We have complete confidence, however, in our sources.

The plot to knock off Castro began as part of the Bay of Pigs operation. The intent was to eliminate the Cuban dicta-

tor before the motley invaders landed on the island. Their arrival was expected to touch off a general uprising, which the Communist militia would have had more trouble putting down without the charismatic Castro to lead them.

After the first attempt failed, five more assassination teams were sent to Cuba. The last team reportedly made it to a rooftop within shooting distance of Castro before they were apprehended. This happened around the last of February or first of March, 1963.

Nine months later, President Kennedy was gunned down in Dallas by Lee Harvey Oswald, a fanatic who previously had agitated for Castro in New Orleans and had made a mysterious trip to the Cuban Embassy in Mexico City.

Among those privy to the CIA conspiracy, there is still a nagging suspicion—unsupported by the Warren Commission's findings—that Castro became aware of the U.S. plot upon his life and somehow recruited Oswald to retal-

iate against President Kennedy.

To set up the Castro assassination, the CIA enlisted Robert Maheu, a former FBI agent with shadowy contacts, who had handled other undercover assignments for the CIA out of his Washington public relations office. He later moved to Las Vegas to head up billionaire Howard Hughes' Nevada operations.

Maheu recruited John Roselli, a ruggedly handsome gambler with contacts in both the American and Cuban underworlds, to arrange the assassination. The dapper, hawk-faced Roselli, formerly married to movie actress June Lang, was a power in the movie industry until his conviction with racketeer Willie Bioff in a million-dollar Hollywood labor shakedown. The CIA assigned two of its most trusted operatives, William Harvey and James (Big Jim) O'Connell, to the hush-hush murder mission. Using phony names, they accompanied Roselli on trips to Miami to line up the assassination teams.

The full story reads like the script of a James Bond movie,

complete with secret trysts at glittering Miami Beach hotels and midnight powerboat dashes to secret landing spots on the Cuban coast. Once Roselli's boat was shot out from under him.

For the first try, the CIA furnished Roselli with special poison capsules to slip into Castro's food. The poison was supposed to take three days to act. By the time Castro died, his system would throw off all traces of the poison, so he would appear to be the victim of a natural if mysterious ailment.

Roselli arranged with a Cuban, related to one of Castro's chefs, to plant the deadly pellets in the dictator's food. On March 12, 1961, Roselli delivered the capsules to his contact at Miami Beach's glamorous Fontainebleau Hotel.

A couple of weeks later, just about the right time for the plot to have been carried out, a report out of Havana said Castro was ill. But he recovered before the Bay of Pigs invasion on April 17, 1961.

Four more attempts were made on Castro's life.

© 1971, Bell-McCune Syndicate, Inc.

ALL INFORMATION CONTAINED

HEREIN IS UNCLASSIFIED

DATE 3/10/81 BY SP4-jm/kcc Date

Note: Cover Memo Classified 6/1/82 stat

get 1/22

62-80750-4811

XEROX

ENCLOSURE

22 1971

*Memo W.R. Wiroell
Mr. C.V. Brennan, 11
Re: CIA's Involvement
in Attempts to Assassinate
O.H.V. any*

Tolson _____
 Sullivan _____
 Mohr _____
 Bishop _____
 Brennan, C.D. _____
 Callahan _____
 Casper _____
 Conrad _____
 Felt _____
 Gale _____
 Rosen _____
 Tavel _____
 Walters _____
 Soyars _____
 Tele. Room _____
 Holmes _____
 Gandy _____

*See memo Wannell to
 Brennan 11/18/71
 Re: Central Intelligence
 Agency involvement in
 plans to assassinate
 Castro and 1/18/71*

W.D.

The Washington Merry-Go-Round

6 Attempts to Kill Castro Laid to CIA

By Jack Anderson

Locked in the darkest recesses of the Central Intelligence Agency is the story of six assassination attempts against Cuba's Fidel Castro.

For 10 years, only a few key people have known the terrible secret. They have sworn never to talk. Yet we have learned the details from sources whose credentials are beyond question.

We spoke to John McCone, who headed the CIA at the time of the assassination attempts. He acknowledged the idea had been discussed inside the CIA but insisted it had been "rejected immediately." He vigorously denied that the CIA had ever participated in any plot on Castro's life. Asked whether the attempts could have been made with his knowledge, he replied: "It could not have happened."

We have complete confidence, however, in our sources.

The plot to knock off Castro began as part of the Bay of Pigs operation. The intent was to eliminate the Cuban dicta-

tor before the motley invaders landed on the island. Their arrival was expected to touch off a general uprising, which the Communist militia would have had more trouble putting down without the charismatic Castro to lead them.

After the first attempt failed, five more assassination teams were sent to Cuba. The last team reportedly made it to a rooftop within shooting distance of Castro before they were apprehended. This happened around the last of February or first of March, 1963.

Nine months later, President Kennedy was gunned down in Dallas by Lee Harvey Oswald, a fanatic who previously had agitated for Castro in New Orleans and had made a mysterious trip to the Cuban Embassy in Mexico City.

Among those privy to the CIA conspiracy, there is still a nagging suspicion—unsupported by the Warren Commission's findings—that Castro became aware of the U.S. plot upon his life and somehow recruited Oswald to retal-

*See
 Anderson*

- The Washington Post Times Herald 8-7
- The Washington Daily News _____
- The Evening Star (Washington) _____
- The Sunday Star (Washington) _____
- Daily News (New York) _____
- Sunday News (New York) _____
- New York Post _____
- The New York Times _____
- The Daily World _____
- The New Leader _____
- The Wall Street Journal _____
- The National Observer _____
- People's World _____

Date JAN 18 1971

ALL INFORMATION CONTAINED
 HEREIN IS UNCLASSIFIED
 DATE 3/10/81 BY SP4-jml/ka

3 XEROX, 62-70750-4811
 APR 22 1971 ENCLOSURE

late against President Kennedy.

To set up the Castro assassination, the CIA enlisted Robert Maheu, a former FBI agent with shadowy contacts, who had handled other undercover assignments for the CIA out of his Washington public relations office. He later moved to Las Vegas to head up billionaire Howard Hughes' Nevada operations.

Maheu recruited John Roselli, a ruggedly handsome gambler with contacts in both the American and Cuban underworlds, to arrange the assassination. The dapper, hawk-faced Roselli, formerly married to movie actress June Lang, was a power in the movie industry until his conviction with racketeer Willie Bioff in a million-dollar Hollywood labor shakedown. The CIA assigned two of its most trusted operatives, William Harvey and James (Big Jim) O'Connell, to the hush-hush murder mission. Using phony names, they accompanied Roselli on trips to Miami to line up the assassination teams.

The full story reads like the script of a James Bond movie,

complete with secret trysts at glittering Miami Beach hotels and midnight powerboat dashes to secret landing spots on the Cuban coast. Once, Roselli's boat was shot out from under him.

For the first try, the CIA furnished Roselli with special poison capsules to slip into Castro's food. The poison was supposed to take three days to act. By the time Castro died, his system would throw off all traces of the poison, so he would appear to be the victim of a natural if mysterious ailment.

Roselli arranged with a Cuban, related to one of Castro's chefs, to plant the deadly pellets in the dictator's food. On March 13, 1961, Roselli delivered the capsules to his contact at Miami Beach's glamorous Fontainebleau Hotel.

A couple of weeks later, just about the right time for the plot to have been carried out, a report out of Havana said Castro was ill. But he recovered before the Bay of Pigs invasion on April 17, 1961.

Four more attempts were made on Castro's life.

© 1971, The McGraw-Hill Companies, Inc.

Tolson ✓
 Sullivan ✓
 Mohr ✓
 Bishop ✓
 Brennan, C.D. ✓
 Callahan _____
 Casper _____
 Conrad _____
 Felt _____
 Gale _____
 Rosen _____
 Tavel _____
 Walters _____
 Soyars _____
 Tele. Room _____
 Holmes _____
 Gandy _____

The Washington Merry-Go-Round

Castro Plot Raises Ugly Questions

D12
By Jack Anderson

The plot to kill Cuban dictator Fidel Castro, hidden for 10 years from the public, raises some ugly questions that high officials would rather keep buried deep inside the Central Intelligence Agency.

1. Has the CIA tried to assassinate any other leaders? John McCone, who headed the CIA during the six attempts to knock off Castro, denied emphatically that the CIA has tried to kill anyone. But ex-Sen. George Smathers, one of John F. Kennedy's closest friends, told us the late President suspected that the CIA had arranged the shootings of the Dominican Republic's Rafael Trujillo in 1961 and South Vietnam's Ngo Dinh Diem in 1963.

2. Did President Kennedy personally sanction the plot against Castro? The preparations to assassinate the Cuban dictator began during the last months of the Eisenhower administration as part of the Bay of Pigs scheme. All six attempts, however, were made during 1961-63 when Mr. Kennedy occupied the White House. Smathers told us he once spoke to the late President about assassinating Castro. Mr. Kennedy merely rolled back his eyes, recalled Smathers, as if to indicate the idea was too wild to discuss. Subsequently, Mr. Kennedy told Smathers of his suspicion that the CIA may have been

behind the Trujillo and Diem assassinations.

3. Did the late Robert Kennedy know about the assassination attempts? After the Bay of Pigs fiasco, President Kennedy swore to friends he would like "to splinter the CIA in a thousand pieces and scatter it to the winds." He put his brother, Robert, in charge of the CIA with instructions to shake it up. The CIA made five attempts on Castro's life after the Bay of Pigs while Robert Kennedy was riding herd on the agency.

4. Could the plot against Castro have backfired against President Kennedy? The late President was murdered nine months after the last assassination team was caught on a Havana rooftop with high-powered rifles. Presumably, they were subjected to fiendish tortures until they told all they knew. None of the assassination teams, however, had direct knowledge of the CIA involvement. The CIA instigators had represented themselves as oilmen seeking revenge against Castro for his seizure of oil holdings.

PLOT BACKFIRE?

Former associates recall that Robert Kennedy, deeply despondent, went into semi-seclusion after his brother's assassination. Could he have been tormented by more than natural grief? He certainly learned that the assassin, Lee Harvey Oswald, had been active in the pro-Castro move-

The last surviving brother, Sen. Ted Kennedy (D-Mass), could give us no insight. His brothers had never spoken to him about any assassination attempts against Castro, he said. He was aware, he volunteered, only that Sen. Smathers had talked to the late President about eliminating Castro.

Smathers told us that President Kennedy seemed "horrified" at the idea of political assassinations. "I remember him saying," recalled Smathers, "that the CIA frequently did things he didn't know about, and he was unhappy about it. He complained that the CIA was almost autonomous."

Watters
Jack

- The Washington Post Times Herald D-15
- The Washington Daily News _____
- The Evening Star (Washington) _____
- The Sunday Star (Washington) _____
- Daily News (New York) _____
- Sunday News (New York) _____
- New York Post _____
- The New York Times _____
- The Daily World _____
- The New Leader _____
- The Wall Street Journal _____
- The National Observer _____
- People's World _____

Date JAN 19 1971

ALL INFORMATION CONTAINED
HEREIN IS UNCLASSIFIED
DATE 3/10/81 BY SP4 Jmk/ka

62-70750-4811
LOSURE

3
Jan 23 1971
12

"He told me he believed the CIA had arranged to have Diem and Trujillo bumped off. He was pretty well shocked about that. He thought it was a stupid thing to do, and he wanted to get control of what the CIA was doing."

But McCone, disagreeing vigorously, told us that "no plot was authorized or implemented" to assassinate Castro, Trujillo, Diem or anyone else.

"During those days of tension, there was a wide spectrum of plans ranging from one extreme to another," McCone admitted. "Whenever this subject (assassinating Castro) was brought up—and it was — it was rejected immediately on two grounds. First, it would not be condoned by anybody. Second, it wouldn't have achieved anything."

There was also talk in high places, McCone acknowledged, of supporting a coup to oust Diem. The former CIA director said he had argued against this at a secret session with both Kennedy brothers. He had contended that there was no one strong enough to take Diem's place and that a coup, therefore, would bring "political upheaval."

"I told the President and Bobby together," recalled McCone, "that if I were running a baseball team and had only one pitcher, I wouldn't take him out of the game."

The November, 1963, coup caught the United States completely by surprise, he said. While the plotters were moving on the palace, he said, then-Ambassador Henry Cabot Lodge was visiting Diem. Adm. Ulysses Sharp, then our Pacific commander, had also been present, but had left early to go to the airport.

McCone said President Diem escaped through a tunnel but was caught in nearby Cholon and "shot in a station wagon."

ROUTE IN ENVELOPE

TOP SECRET

- 1 - Mr. DeLoach
- 1 - Mr. Gale
- 1 - Mr. Wick
- 1 - Mr. Sullivan

The Attorney General

March 6, 1967

Director, FBI

- 1 - Mr. Papich
- 1 - Mr. Wannall
- 1 - Inspector

CENTRAL INTELLIGENCE AGENCY'S INTENTIONS TO SEND HOODLUMS TO CUBA TO ASSASSINATE CASTRO

DECLASSIFIED BY SP4 GJM/KZA ON 3/10/81 FILE # 22,330 CIA info declassified per John E. Bacon 8/27/80

Our files contain the following information concerning the captioned matter, much of which has been furnished by the Central Intelligence Agency (CIA) on a strictly highly confidential "need-to-know" basis. In view of this, it is requested that it be handled on a most restrictive basis. (u)

This matter first came to our attention in the Spring of 1961 in connection with our investigation of a violation of the Unauthorized Publication or Use of Communications Statute on the part of Arthur James Balletti, who had been arrested by local authorities in Las Vegas, Nevada, on a local wire tapping charge. Balletti and another unidentified individual in October, 1960, had reportedly placed a wire tap on the telephone of Dan Rowan, a member of the comedy team of Rowan and Martin. Rowan at the time reportedly was engaged to Fayllis McGuire of the well-known McGuire Sisters singing trio who was also known to be a girl friend of Sam Giancana, a top hoodlum. U

MAILED 2
MAR 6 1967
COMM-FBI

During the course of the Balletti investigation it was ascertained that Robert A. Maheu, a private detective, was involved. Maheu during interview claimed he ordered coverage of Rowan in behalf of CIA's efforts to obtain intelligence information in Cuba through the hoodlum element, including Sam Giancana, which had interests there. Maheu said he was put in contact with Giancana in connection with these intelligence activities through John Roselli, a Los Angeles hoodlum. Maheu stated also that he authorized the wiring of Rowan's room and had discussed the matter with Roselli. 62-80750-4523

The essence of the above was furnished to former Attorney General Robert F. Kennedy by letter dated May 22, 1961, which enclosed a memorandum of the same date containing data made available on May 3, 1961, by Colonel Sheffield Edwards, who at that time was Director of Security at CIA, regarding his utilization of Maheu in connection with anti-Castro activities. Since our files show that Mr. Kennedy returned the original of our letter and its enclosed memorandum dated May 22, 1961.

- DeLoach
- Wick
- Mohr
- Bishop
- Callahan
- Conrad
- Felt
- Gale
- Rosen
- Sullivan
- Tavel
- Trotter
- Tele. Room
- Holmes
- Gandy

GCH:ams(1)

SEE NOTE, PAGE 4

29-MAR-13-1967

TELETYPE UNIT

TOP SECRET

GROUP 1
Excluded from automatic downgrading and declassification

ENCLOSURE

~~TOP SECRET~~

The Attorney General

to us for filing purposes, a copy of the May 22, 1961, memorandum is attached hereto for your information. (u)

You will note that Colonel Edwards advised he personally contacted Robert Maheu during the Fall of 1960 for the purpose of using Maheu as a "cutout" in contacts with Sam Giancana in connection with CIA's clandestine efforts against Castro. Colonel Edwards stated that Giancana's activities were completely "backstopped" by Maheu, who would frequently report Giancana's actions and information to Edwards. No details or methods used by Maheu or Giancana in accomplishing their missions were reported to him, according to Edwards, as such involved "dirty business," of which Colonel Edwards could not afford to have knowledge. Accordingly, he said he had no prior knowledge of the above-mentioned wire tapping by Balletti. (u)

Further with respect to this matter, I was informed of the following on a highly confidential basis by former Attorney General Kennedy during a conference in my office on May 9, 1962:

He indicated that a few days prior thereto he had been advised by CIA that Robert A. Maheu had been hired by CIA to approach Sam Giancana with a proposition of paying \$150,000 to hire some gunmen to go into Cuba and kill Castro. He further stated CIA admitted having assisted Maheu in making the "bugging" installation in Las Vegas (referred to above) which uncovered this clandestine operation and for this reason CIA could not afford to have any action taken against Giancana or Maheu. Mr. Kennedy stated that upon learning CIA had not cleared its action in hiring Maheu and Giancana with the Department of Justice he issued orders that CIA should never again take such steps without first checking with the Department of Justice.

Mr. Kennedy further advised that because of this matter it would be very difficult to initiate any prosecution against Giancana, as Giancana could immediately bring out the fact the United States Government had approached him to arrange for the assassination of Castro. He stated the same was true concerning any action we might take against Maheu for any violation in which he might become involved.

On June 20, 1963, Mr. William Harvey, an official of CIA, advised that he had held a meeting with John Roselli (referred to above as Maheu's link with Giancana) for the purpose of closing out the entire matter with which Roselli had been involved. In this connection, Harvey stated that CIA had

- 2 -

~~TOP SECRET~~

The Attorney General

established contact with Roselli in "early 1961" with respect to a sensitive operation against Castro. Harvoy said that for all intents and purposes the operation was discontinued and canceled after the ill-fated Bay of Pigs invasion in April, 1961, but Roselli had not been completely cut off, as he periodically indicated he was in a position to be of assistance.

It appears Roselli has since that time, nevertheless, used his prior connections with CIA to his best advantage. For example, in May, 1966, when contacted by Agents of this Bureau in connection with our current investigation of his activities he refused to talk and immediately flew to Washington, D. C., and consulted with Colonel Sheffield Edwards, who is now retired from CIA. Colonel Edwards in turn advised CIA, which told us. Mr. Howard J. Osborn, the present Director of Security, CIA, freely has admitted to us that Roselli has CIA in an unusually vulnerable position and that he would have no qualms about embarrassing CIA if it served his own interests. In furnishing this information, Mr. Osborn asked that it be held within this Bureau on a strictly need-to-know basis. *XS(u)*

In light of the above information furnished us by CIA and former Attorney General Kennedy, it appears that data which came to our attention in October, 1960, possibly pertains to the captioned matter. At that time a source close to Giancana advised that during a conversation with several friends Giancana stated that Fidel Castro was "to be done away with very shortly." Giancana reportedly assured those present that Castro's assassination would occur in November, 1960, and that he had already met with the assassin-to-be on three occasions, the last meeting having taken place on a boat docked at the Fontainebleau Hotel, Miami Beach, Florida. Reportedly, Giancana claimed that everything had been perfected for the killing and the "assassin" had arranged with a girl, not further described, to drop a "pill" in Castro's drink or food.

Also of possible interest is a news article carried in the August 16, 1963, issue of the "Chicago Sun Times." This article carried the headline, "CIA Sought Giancana's Help For Cuba Spying," and it was reported therein that CIA agents had contacted Giancana in an effort to obtain Cuban intelligence after Castro came into power. *u*

Enclosure

1 - The Deputy Attorney General (Enclosure)

~~TOP SECRET~~

The Attorney General

NOTE:

See cover memorandum Wannall to Sullivan, same caption,
March 6, 1967, GCM:ams.

Classified "Top Secret" inasmuch as information contained
herein is so classified by CIA.

- 4 -

~~TOP SECRET~~

*Unsanitized
 Containing
 info on
 139-1201-43
 139-1201-43
 139-1201-43
 139-1201-43*

DECLASSIFIED BY SP4 Jmm/Kear
 ON 3/10/81 TO FOIA # 22,330
 CIA Info Declassed per
 John E. Bacon 8/27/80
 May 22, 1961

~~CONFIDENTIAL~~

ARTHUR JAMES DALLETTI, et al.

On May 3, 1961, Colonel Sheffield Edwards,
 Director of Security, Central Intelligence Agency (CIA)
 furnished the following information.

Colonel Edwards advised that in connection with
 CIA's operation against Castro he personally contacted Robert
 Mahou during the Fall of 1960 for the purpose of using Mahou
 as a "cut-out" in contacts with Sam Giancana, a known hoodlum
 in the Chicago area. Colonel Edwards said that since the
 underworld controlled gambling activities in Cuba under the
 Batista government, it was assumed that this element would
 still continue to have sources and contacts in Cuba which
 perhaps could be utilized successfully in connection with
 CIA's clandestine efforts against the Castro government.
 As a result, Mahou's services were solicited as a "cut-out"
 because of his possible entree into underworld circles.
 Mahou obtained Sam Giancana's assistance in this regard and
 according to Edwards, Giancana gave every indication of
 cooperating through Mahou in attempting to accomplish several
 clandestine efforts in Cuba. Edwards added that none of
 Giancana's efforts have materialized to date and that several
 of the plans still are working and may eventually "pay off."

*6099-2-61ab
 B12577-61ab*

Colonel Edwards related that he had no direct
 contact with Giancana; that Giancana's activities were
 completely "back stopped" by Mahou and that Mahou would
 frequently report Giancana's action and information to
 Edwards. No details or methods used by Mahou or Giancana
 in accomplishing their missions were ever reported to
 Edwards. Colonel Edwards said that since this is "dirty
 business" he could not afford to have knowledge of the actions
 of Mahou and Giancana in pursuit of any mission for CIA.
 Colonel Edwards added that he has neither given Mahou any
 instruction to use technical installations of any type nor has
 the subject of technical installations ever come up between
 Edwards and Mahou in connection with Giancana's activity.

ORIGINAL TO DEPARTMENT

- Director _____
- Deputy _____
- Asst. Dir. _____
- Adm. Serv. _____
- Ident. _____
- Intell. _____
- Lab. _____
- Legal Coun. _____
- Plan. & Insp. _____
- Rec. Mgmt. _____
- Tech. Serv. _____
- Training _____
- Off. Liaison _____
- Tele. Room _____
- Director's Sec'y _____

EJM:aeq/10
 (14)

- 1 - Mr. Evans
- 1 - Mr. Belmont

See cover memo to AG, 5/22/61, same caption, EJm:aeo

MAIL ROOM TELETYPE UNIT

ENCLOSURE

139-1201-43
 62-80747-5138

~~CONFIDENTIAL~~

MAY 19 1961

~~CONFIDENTIAL~~

Colonel Edwards related that Maheu did come to him concerning the arrest in Las Vegas of Balletti for "wire tapping." Maheu cautioned Edwards that the Balletti arrest could cause CIA some embarrassment since Balletti was in Las Vegas attempting to obtain coverage on some "Hollywood people" in connection with Giancana's efforts for CIA. Edwards said that he did not know the facts of the Balletti case and Maheu claims "Balletti went too far" in his efforts to obtain information. Edwards added that he was unaware of any reason for this activity of Maheu or Giancana in Las Vegas and that Giancana's activity in furtherance of the anti-Castro activity was left completely in Maheu's hands.

Colonel Edwards advised that only Mr. Bissell (Deputy Director of Plans, CIA) and two others in CIA were aware of the Giancana - Maheu activity in behalf of CIA's program and that Allen Dulles was completely unaware of Edwards' contact with Maheu in this connection. He added that Mr. Bissell, during his recent briefings of General Taylor and the Attorney General in connection with their inquiries into CIA relating to the Cuban situation, told the Attorney General that some of CIA's associated planning included the use of Giancana and the underworld against Castro.

"Property of FBI
This report and its contents are
loaned to you by the FBI and
neither it nor its contents are
to be distributed outside the agency
to which loaned."

~~CONFIDENTIAL~~

Airtel to SAC, Tampa
 Re: JULY 26 MOVEMENT, TAMPA, FLORIDA
 REGISTRATION ACT - CUBA
 INTERNAL SECURITY - CUBA

103491

attorney of Tampa, Florida, was working on the case and [redacted]
 [redacted] is apparently identical
 with [redacted] Tampa, Florida.)

b6
 b7C

Bufiles do not indicate that the Tampa Office has initiated an investigation of the July 26 Movement there. The scope and seriousness of the organizational activity, heavily infiltrated by communists, as described in the attached document give rise to the questions not only of whether there is some validity to the data but also of whether the prior coverage of the Cuban situation by the Tampa Office will enable an accurate appraisal. This is particularly true in the absence of any past intensive investigative attack upon the July 26 Movement activity in Tampa. It is recognized that data provided by [redacted] may be colored to some extent by his anti-Castro position. However, this information cannot be discounted and must be resolved investigatively.

By 12-1-60 the Bureau desires that the Miami Office submit a complete and detailed report on the organized activities of the July 26 Movement, Tampa, Florida, from inception to the point that the Tampa Office was created. This should include all pertinent data available during that period. The report should also include all pertinent data from the attached document regarding the applicable period together with all pertinent data available or which can be acquired investigatively which would serve to show the authenticity of the data or the lack thereof on the basis of facts. This report deadline of 12-1-60 must be met. The report should be carefully organized with headings and subheadings where appropriate and a table of contents. Miami should include any comments or conclusions as to the validity of the [redacted] data in an airtel accompanying the report.

b7D

The Tampa Office, as office of origin, must submit its first report no later than 12-12-60. It should cover the period from the creation of the Tampa Office to date and include all pertinent data developed regarding the subject organization during that period, pertinent data from the attached document applicable to that period and to the present time and data which would to establish by facts the validity, or lack thereof, of the [redacted] supplied by [redacted]. The Tampa Office should include any [redacted] comments or conclusions as to the validity of the [redacted] data in [redacted]

- 2 -

97-4455-1

TELETYPE UNIT

Airtel to SAC, Tampa
Re: JULY 26 MOVEMENT, TAMPA, FLORIDA
REGISTRATION ACT - CUBA
INTERNAL SECURITY - CUBA

103492

an airtel accompanying its report. Included in that airtel should be a specific listing of all separate investigative cases now pending or which have been initiated on individuals named in the document. This listing should include the full title, character, Tampa, file number and Bureau file number, where available. Under no circumstances should this organizational file be utilized as a framework within which to initiate and report separate investigations regarding individuals. Data pertinent to the over-all organizational picture should, of course, be extracted from individual case files and included in reports in this case. b7D

The later deadline of 12-12-60 has been set for the Tampa Office to prevent duplicate reporting and to allow a sensible chronology in the presentation of data. This matter must receive continuous and preferred attention in both offices and sufficient personnel must be assigned to meet the deadlines set and to do an effective job.

November 10, 1960

40232

Airtel

743

To: SAC, Tampa (Enclosures - 2)
2 - Miami (Enclosure)

From: Director, FBI

Subject: JULY 26 MOVEMENT, TAMPA, FLORIDA
REGISTRATION ACT - CUBA
INTERNAL SECURITY - CUBA

Attached for the information of the Tampa Office are two Photostats of a "Report on 'The 26th of July Movement Club' of Tampa, Florida." One Photostat is attached for the Miami Office.

This report was made available to the Bureau by

on 11-7-60. advised the report

was prepared by who apparently is associated in some way with a a lawyer in Tampa, Florida. The fact that the report was received from

b6
b7C
b7D

should not be disclosed outside the Bureau in interviews, correspondence or any manner. In reporting data from the document it should be attributed to T-1, a source who has furnished reliable information in the past. who received the information from

According to an incoming airgram from the American Embassy in Ottawa, Canada, to the Department of State, dated 11-7-60, classified "Confidential."

This information came from the Canadian Immigration authorities who advised they were seeking to . The also indicated an

Document received by SA E.C. Kemper from advised Kemper upon recontact on 11-7-60. FBI is free to utilize data investigatively.

NOV 16 1960

NOV 10 1960
COMM-FBI

Person
Mr.
Messrs.
Mr. Tolson
Mr. DeLoach
Mr. Mohr
Mr. Bishop
Mr. Casper
Mr. Callahan
Mr. Conrad
Mr. Felt
Mr. Gale
Mr. Rosen
Mr. Sullivan
Mr. Tavel
Mr. Trotter
Tele. Room
Miss Holmes
Miss Gandy

ENCLOSURE

SED:dmd (8)

51 NOV 22 1960

104

ALL INFORMATION CONTAINED
HEREIN IS UNCLASSIFIED
DATE 02-19-2010 BY UC 60322 LP/STP/SZ



ENCLOSURE

ENCLOSURE

97-4455-1

ALL INFORMATION CONTAINED
HEREIN IS UNCLASSIFIED
DATE 02-22-2010 BY UC 60322 LP/STP/SZ

F B I

Date: 11/30/60

26 of July Movement TAMPA, FLORIDA

Transmit the following in PLAIN TEXT
(Type in plain text or code)

AIRTEL AIR MAIL REGISTERED
(Priority or Method of Mailing)

TO: DIRECTOR, FBI (105-82024)
FROM: SAC, TAMPA (97-2) *97-3214*
SUBJECT: JULY 26 MOVEMENT, TAMPA, FLORIDA
REGISTRATION ACT - CUBA
INTERNAL SECURITY - CUBA *97-217 TAMPA*

2/
51

ReBuairtel 11/10/60 which enclosed a report allegedly prepared by [redacted] captioned "Report on 'The 26th of July Movement Club' of Tampa, Florida." Mention was made therein of [redacted] Tampa attorney, said to be representing [redacted]

b6
b7C
b7D

In order that the Bureau may better evaluate the above-mentioned report the following information is submitted:

The last four pages of the [redacted] report" consists of a list of names of individuals with comments beside each name. It was at once apparent to the Tampa SAs investigating Cuban matters that this list bore great similarity to a list of names received 10/13/60 by SA [redacted] from [redacted] now a PSI of Tampa office. A comparison of the two lists shows they contain the same names and addresses except that [redacted] list contains one name, [redacted] which was not included on the [redacted] list, and the latter contains six names not on [redacted] list. These six are the last five names on [redacted] list and that of [redacted]. Even the order in which the names are listed is similar although there are some variations in the order. The nicknames [redacted] and [redacted] appear on both lists, as do the incomplete names [redacted]. Whereas the [redacted] list contains the incomplete name [redacted] did not name this person but merely listed him as [redacted].

It is noted the only name omitted from the [redacted] list, [redacted] is also the only name on [redacted] list concerning whom there was no identifying data.

- 3 - Bureau (RM-AM)
- 1 - Miami (97-268) (Info) (RM-AM)
- 2 - Tampa

EX-105
REC-72

97-3214-3
97-4455-2
DEC 2 1960

Approved: *[Signature]*
Special Agent in Charge.

Sent

M. P. SEC.
NAC

51 DEC 16 1960

Principal differences noted in the two lists are as follows: Whereas the [redacted] list is captioned "List of Members of the Communist Cell Inside the 26th of July Movement Club of Tampa, Florida", [redacted] identified his list as merely the names of people affiliated with one of the pro-FIDEL CASTRO organizations in Tampa, the Patriotic Movement of Tampa for Aid to Cuban Farmers or the 26th of July Movement. Moreover, the comments in [redacted] list are for the most part identifying data only such as residence, employment, affiliation, whereas the [redacted] list contains in almost every instance additional comments such as "Agent of the D.I.E.R.", "Active member of the Communist Party", etc.

From the foregoing comparison it was apparent that:

- (1) [redacted] had obtained the list from [redacted] or (2) [redacted] had obtained his list from [redacted] or (3) [redacted] and [redacted] had each obtained the list from a common source.

On 11/23/60 PSI [redacted] advised SAs [redacted] and [redacted] that the list he had furnished was personally prepared by him from his own knowledge of the individuals thereon or from information he has received concerning them from his associates in Tampa. He said the only copies of the list other than the one furnished the FBI were given by him to [redacted]

b6
b7C
b7D

[redacted] and to [redacted] Miami. On further questioning he admitted he did not personally deliver the list to [redacted] but gave it to "an intermediary" [redacted]. Although obviously reluctant to identify this "intermediary" he eventually did so, saying [redacted]. He requested this information be kept confidential. [redacted] was asked whether he had information any of the persons on the list was an agent of the D.I.E.R. or whether he had ever told anyone these people were D.I.E.R. agents. He said he never did so for the reason he has no way of knowing who might or might not be an agent of D.I.E.R.

Reference is made to Buairtel to Tampa 11/8/60 captioned [redacted] "IS-Cuba" wherein mention was made of a [redacted]. [redacted] It is suggested the [redacted] mentioned therein was probably [redacted].

TP 97-2 .

On 11/30/60 [redacted]
Tampa, who was [redacted] and
who has previously furnished information concerning Cuban matters,
advised SA [redacted] she knows [redacted]
[redacted] She
said [redacted] is a "nice girl" but she volunteered the comment
that little credence can be put in anything she says. She said
[redacted] she came here from Cuba
and started work at the [redacted]
[redacted] often
says things without any basis in fact and apparently without
realizing the consequences thereof. I want to emphasize that no
indication was given [redacted] that this office had received
any information from [redacted] She was approached on the
pretext the SA was considering whether [redacted] might have
information of value re Cuban activities.

b6
b7C
b7D

[redacted] further stated that [redacted]
[redacted] support of the FIDEL
CASTRO revolution and that, in fact, [redacted] has always
been pro-BATISTA. She explained that [redacted]
[redacted]

Records of the Clerk of Circuit Court, Hillsborough
County Courthouse, were checked 11/30/60 by SA [redacted] and
they reflect [redacted]
[redacted]

While the [redacted] report contains much information that
is true, it makes many allegations incapable of proof and contains
some errors. The organization described in paragraph 2 on page
2 which is called "Comite de Ayuda a la Liberacion Cubana" actually
appears to refer to the Committee for Revolutionary Unity, which
was described in report under that caption by SA [redacted]
Miami, February 4, 1958, Bufile 97-3449. The organization de-
scribed in paragraph 2, page 3 and called "Club Patriotico 26 de
Julio" appears actually to refer to the Patriotic Movement of
Tampa for Aid of Cuban Farmers (Bufile 97-4219). [redacted]
[redacted]

DIRECTOR, FBI (100-157394)

11/29/60

SAC, TAMPA (100-27)

SM - C

aka

July 26 Movement

Rebuairtel 11/10/60 entitled "July 26 Movement, Tampa, Fla.,
Registration Act - Cuba; Internal Security - Cuba" with
attached photostat of "Report" on this organization. The
second name on page 7 of this document is shown as [redacted] 5-
whose last name was not known, [redacted]

It appears that the [redacted] referred to in this report is
identical with above captioned subject who is described as
[redacted]
Tampa, Florida.

b6
b7C
b7D

Instant case was opened under Reserve Index Program. Subject's
residence verified and information developed through PSI
[redacted] on 10/13/60 that subject is [redacted] and
makes statements in favor of Russia and Communism [redacted]

[redacted] (protect identity) has stated that subject is
pro-CASTRO and critical of the United States.

PCI [redacted] on 10/23/60 advised that although subject
makes pro-Communist and pro-CASTRO statements, he is generally
[redacted]

Subject was formerly on Security Index, but was removed from
Security Index in June, 1955.

C

3-Bureau
(1cc Bufile re 26th of July Movement, Tampa, Florida,
RA - Cuba; IS - Cuba)

3-Tampa
(1- 97-2)
(1- 100-63)

FCH; jap
(6)

97 4455-
NOT RECORDED
185 DEC 1 1960

51 DEC 7 1960

151
1960

100-157394-14

TP 100-27

In view of the foregoing information, subject is being retained in Section B of the Reserve Index and this case is being closed, subject to re-opening if subject's activities warrant such action.



ALL INFORMATION CONTAINED
HEREIN IS UNCLASSIFIED
DATE 02-22-2010 BY UC 60322 LP/SZ



F B I

Date: 12/1/60

Transmit the following in _____
(Type in plain text or code)

Via AIRTEL _____
(Priority or Method of Mailing)

TO: DIRECTOR (105-82024)

FROM: SAC, TAMPA (97-2)

JULY 26 MOVEMENT, TAMPA, FLORIDA
REGISTRATION ACT - CUBA
INTERNAL SECURITY - CUBA

*0-7 to Tampa
in the future
Bureau 10 97-4455
12-15-60
6RH:veo*

103490

b6
b7C
b7D

ReBuairtel 11/10/60 and TP airtel 11/30/60; both of which make reference to a report allegedly prepared by [redacted] captioned "Report on 'The 26th of July Movement Club' of Tampa, Florida."

Reference is now made to Bulet to Miami 11/29/60 captioned "CUBAN INTELLIGENCE ACTIVITIES IN THE UNITED STATES; IS-CUBA."

It is believed that this office has pretty well established that the list furnished by [redacted] emanated from [redacted] and that, as pointed out in TP refairtel, someone along the line added a few names plus uncorroborated statements indicating certain individuals as DIER agents.

It is suggested that if the Bureau has not already done so, they request the [redacted] list to have [redacted] questioned along the lines set out in Bulet 11/29/60 concerning Cuban intelligence activities.

OOI REC-88

97-4455-3

*Have checked
with Committee
Conclude with
12-1-60*

It would appear to me that [redacted] is undoubtedly trying to "sell a bill of goods" to somebody in the United States with bald statements and for his own personal benefit, [redacted]

3 Bureau (RM)
3 Tampa (1 - 105-13)
JFS:KH
(6)

20 DEC 3 1960

[Handwritten signatures and initials]

Approved: 62 DEC 20 1960
Special Agent in Charge

97-4455

Sent _____ M Per _____

FEDERAL BUREAU OF INVESTIGATION

b6
b7c

Reporting Office MIAMI	Office of Origin TAMPA	Date 12/5/60	Investigative Period 11/16-29/60	40229
----------------------------------	----------------------------------	------------------------	--	--------------

TITLE OF CASE JULY 26TH MOVEMENT, TAMPA, FLORIDA	Report made by 	Typed By: sah
--	------------------------	-------------------------

CHARACTER OF CASE
RA - CUBA;
IS - CUBA

Synopsis:
REFERENCE: Bureau airtel to Tampa dated 11/10/60.
- RUC -

ADMINISTRATIVE

This report has been compiled on the basis of a complete review of Miami files 97-139 (Bufile 97-3244) Miami 97-268 (Bufile 105-82024), and a search of Miami indices regarding the names of all individuals mentioned in the attachment to Bureau airtel where pertinent information was located. In this connection, it is noted that the Miami files in certain cases reflected that the file had been transferred to the Tampa Office, and in most of those cases no information was located regarding these individuals.

105 Cds

97-4455-4

- Special Agent in Charge
- 9 - Bureau (RM)
3 - Tampa (97-2) (RM)
1 - Miami (105-2374)

Do not write in spaces below

97-3244-325

DEC 8 1960

Copy to: CIA/State/RAB

ONI/OSI/G2/JAC
by routing slip for info
Date 12-14-60 by ERH/002

DEC 20 1960

62 DEC 21 1960

40230

MM 105-2374

INFORMANTS

Identity of Source

Location of Information

MM T-1 is Report furnished
by [redacted]
[redacted]

105-2374-5

MM T-2 is [redacted]

109-25-40

MM T-3 is PCI [redacted]
[redacted] (Tampa Office)

97-139-26, page 13
97-139-423
97-139-427
97-139-2148

b6
b7C
b2
b7D

MM T-4 is [redacted]

97-139-331
97-139-415

MM T-5 is CS [redacted]
[redacted] (Tampa Office)

97-139-1047
62-1014-4

MM T-6 is Former [redacted]

97-268

MM T-7 is [redacted]
[redacted]

Instant Report, page 19

MM T-8 is Anonymous Source

100-800-617

MM T-9 is Anonymous Source

97-268-200

MM T-10 is [redacted]

100-2164-83, page 7

- B -

COVER PAGE

97-4453-4

Identity of Source

Location of Information

MM T-11 is [redacted]
[redacted] and
captioned [redacted]
[redacted] - R

100-800-1126

MM T-12 is [redacted] (Former)

105-313-2

MM T-13 is [redacted]

MM T-14 is [redacted]

MM T-15 is Former [redacted]

b6
b7C
b2
b7D

100-10286-231

Careful consideration has been given to the sources concealed, and T-symbols were utilized only in those instances where the identities of the informants must be concealed.

- C* -

COVER PAGE

97-4455-4

UNITED STATES DEPARTMENT OF JUSTICE
FEDERAL BUREAU OF INVESTIGATION

ALL INFORMATION CONTAINED
HEREIN IS UNCLASSIFIED
DATE 02-22-2010 BY UC 60322 LP/STP/SZ

Copy to:

Report of:

Office: Miami, Florida

Date: December 5, 1960

Field Office File #: Miami 105-2374

Bureau File #:

b6
b7c

Title:

JULY 26TH MOVEMENT, TAMPA, FLORIDA

Character:

REGISTRATION ACT - CUBA
INTERNAL SECURITY - CUBA

Synopsis:

MM T-1 advised on 11/7/60 that Tampa organization of "July 26th Movement" second in stature in planned infiltration of U.S. by Cuban "Red agents". July 26 Movement, Tampa, Fla., founded in 11/55 on occasion of visit to Tampa by FIDEL CASTRO, leader of July 26 Movement. CASTRO stated purpose of Movement to remove BATISTA Government and restore liberty and democratic government to Cuban people. VICTORIANO MANTEIGA named to head Tampa Club in 11/55. Total of \$191.02 collected at meeting 11/27/55. MANTEIGA advised in 4/56 no July 26 Club then in existence in Tampa, but that he and 3 others met weekly at office of his newspaper, Spanish weekly "La Gaceta", and contributed \$1. per week each for support of CASTRO in Mexico. Stated RAUL VILLAMIA then acting as Secretary-Treasurer. MM T-1 said no "real and positive action" inside this organization until 1957. Said "real revolutionary activities began" 10/15/57 with Comite de Ayuda a la Liberacion Cubana (Committee to Aid Cuban Liberation) (CALC) which included leaders from July 26 Movement and other groups. MM T-3 advised first activity in 1957 on behalf of FIDEL CASTRO took place in Tampa on 6/30/57. July 26 Club members reported to have picketed Cuban Consulate on 7/25/57 per "Tampa Tribune", 7/26/57. "Diario Las Americas", Miami Spanish daily newspaper, published letter from VICTORIANO MANTEIGA, 9/25/57, in which he stated he was then President

MM 105-2374

SYNOPSIS (cont.)

of July 26 Movement of Tampa. Dr. GARCIA MENENDEZ advised 12/57 that Central Committee for Revolutionary Unity formed 10/57 to unite Cubans opposed to BATISTA, and included members of 26 of July Movement. VICTORIANO MANTEIGA advised 11/57 that July 26 Movement, Tampa, had been split and that other groups headed by Dr. GARCIA MEMENDEZ, ANIBAL VELAZ and RAUL VIANA joined Committee for Revolutionary Unity. MANTEIGA advised on 2/13/58 he believed Committee for Revolutionary Unity had died and that he had resigned as President of July 26 Movement of Tampa. "La Gaceta", 1/17/58, listed Dr. EDUARDO V. MIJARES PUJALS as President. MM T-3 advised 3/58 that July 26 Movement activity had come to standstill. July 26 Club demonstration by 8 persons held 12/31/58, downtown Tampa. MM T-1 advised CALC dissolved by CASTRO after fall of BATISTA 1/1/59, and July 26 Club reinstated with FELIPE JIMENEZ as President. Said VICTORIANO MANTEIGA, although appearing retired, is President. "La Gaceta" reported meetings of July 26 Club, Tampa, in August and October, 1959, with CARLOS CARBONELL listed as Secretary. The 2/26/60 issue of "La Gaceta" lists VICTORIANO MANTEIGA as President. MM T-1 alleged all officers and members of July 26 Club of Tampa "are active Communist Party members or agents of CASTRO's G-2 Organization", and furnished "list of members of Communist cell inside the '26th of July Movement Club' of Tampa, Florida." Available information re names listed by MM T-1 set forth. MM T-13 advised that as of 2/3/58 there were 7 CP members in Tampa. Status under Foreign Agents Registration Act of 1938, as amended, set forth.

- RUC -

MM 105-2374

TABLE OF CONTENTS

	<u>Page</u>
I. ORIGIN OF JULY 26TH MOVEMENT OF TAMPA, FLORIDA	2
II. STATUS OF JULY 26TH MOVEMENT OF TAMPA, MID-1957 TO December 31, 1958	8
III. STATUS OF THE JULY 26 TH MOVEMENT OF TAMPA, January 1, 1959, to May 31, 1960	16
IV. ALLEGED COMMUNIST INFILTRATION OF THE JULY 26TH MOVEMENT OF TAMPA	20
V. STATUS UNDER FOREIGN AGENTS REGISTRATION ACT OF 1938, AS AMENDED	29

MM 105-2374

DETAILS:

b7D

All information in this report attributed to MM T-1 was received by MM T-1 from [redacted]

[redacted]

Information was received from MM T-1 on November 7, 1960.

According to MM T-1, the "July 26th Movement" organization in Tampa, Florida, is second in stature in the United States, and first in Florida, in the planned Communist infiltration of the United States by Cuban "Red agents". This is attributed to the large Cuban and inter-related Spanish-Latin colony in Tampa consisting primarily of elements of the "lower social classes or the working class, the ones that give most of their members to the Communist movement throughout the world...", and to the pressure exerted by the "powerful Spanish Commies of Tampa - the oldtimers of the Spanish Civil War - who have remained in obscurity throughout the years, but, who, now, when ordered by the leaders of International Communism rallied around the Cuban Communist Revolutionary Group."

*B. 328-1892 Cuba
Camaguary
Spain
Mexico*

I. ORIGIN OF THE JULY 26TH MOVEMENT OF TAMPA, FLORIDA, November, 1955, to Mid-1957

MM T-1 advised that in 1955, FIDEL CASTRO was in exile in Mexico, and was ordered by General ALBERTO BAYO to visit cities in the United States having a large Latin population, such as New York, Tampa and Miami, to establish 26 of July Movement clubs, which would eventually become an "organized Communist nucleus inside the United States". In connection with the organization of the Tampa club, General BAYO furnished CASTRO with the names of two men, VICTORIANO MANTEIGA, publisher of Spanish newspaper "La Gaceta", and Dr. JORGE A. TRELLES, owner of Dr. Trelles Clinic, Inc. These individuals were contacted

Cuba

*JORGE
TRELLES²*

*Tampa, Fla
Cuba*

MM 105-2374

by emissaries of CASTRO one week prior to his arrival in Tampa. When he reached Tampa, CASTRO was to personally choose one of these individuals to become organizer and head of the July 26 Movement in Tampa. CASTRO subsequently visited Dr. TRELLES, but TRELLES refused the post, not due to any disagreement, but because he was already head of another political organization, Organizacion Autentica, the militant division of the Authentic Party whose head was CARLOS PRIO SOCARRAS, former President of Cuba, overthrown by BATISTA in March, 1952. CASTRO then approached VICTORIANO MANTEIGA, who accepted the position.

MM T-1 advised that on November 25, 1955, a Patriotic Club of the 26 of July Movement was formed at the Union Club, 19th Street and 12th Avenue, Tampa, Fla with officers as follows:

1. VICTORIANO MANTEIGA, President
2. RAUL VILLAMILA, Secretary
3. FLORENTINO SANTOS, Treasurer
4. CARLOS CARBONELL, Chief of Publications.

Regarding General ALBERTO BAYO, mentioned above, it is noted that on July 8, 1957, EDUARDO HERNANDEZ, then Cuban Consul General in Miami, Florida, advised that General BAYO was born March 28, 1892, at Camaguay, Cuba, but later went to Spain, where he served with the Spanish Republican (Loyalists) Army, and following the defeat of that army by forces of FRANCISCO FRANCO, BAYO went to Mexico under the sponsorship of LOMBARDO TOLEDANO, described by HERNANDEZ as a Mexican Communist labor leader.

On November 15, 1955, MM T-2, who was at that time a [redacted] Cuba Fla

[redacted] advised that FIDEL CASTRO RUZ arrived in Miami during the preceding week from Mexico City, where he had been attempting to collect funds for the purpose of overthrowing the BATISTA Government in Cuba. MM T-2 said

MM 105-2374

that CASTRO claimed to lead an organization known as the Patriotic Clubs of July 26, with a large following in Cuba, and that he planned to organize chapters of this club in Miami and Tampa.

On November 23, 1955, [redacted] Investigator, Immigration and Naturalization Service (INS), Miami, advised that FIDEL CASTRO had come to the INS office in Miami, at which time he had been interrogated regarding his status as an alien in the United States. CASTRO, according to [redacted], last entered the United States on October 20, 1955, at San Antonio, Texas. During this interview, CASTRO advised that he entered the United States for the purpose of visiting his son, and at the same time to comply with invitations which Cubans in New York, Miami, Tampa and Key West had made to him for the purpose of explaining to Cubans in the United States the situation in Cuba, as well as his ideas and plans as the leader of the Movement of the 26th of July, 1953. CASTRO said the Movement was so named to commemorate the assassination of 80 young Cubans, who on July 26, 1953, made an unsuccessful attempt to overthrow BATISTA. CASTRO stated that the purpose of the Movement was to remove the BATISTA Government and restore liberty and a democratic system of government to the people of Cuba. He denied that he planned to use force at that time to bring about the downfall of BATISTA, but hoped rather to use the force of public opinion. ✓

b6
b7c

CASTRO said that the money collected in the United States was to be used for publicity purposes, and the general fight. He claimed that he had remained within the laws of the United States, and that he planned to give talks in Tampa and Key West, Florida. He stated that while in Tampa he could be reached at the home of VICTORIANO MANTEIGA, [redacted], Director of the "Tampa Gazette", a Spanish language newspaper. ✓

MM 105-2374

CASTRO stated ~~at this time~~ that he had never been a member of any organization affiliated with the Communist Party (CP).

The Communist Party, USA, has been designated by the Attorney General of the United States pursuant to Executive Order 10450.

On November 23, 1955, MM T-2 advised that CASTRO was leaving Miami for Tampa, Florida, on the following day.

The November 26, 1955, issue of the "Tampa Tribune", a Tampa daily newspaper, carried an article entitled "Anti Batista Cuban Comes Here to Seek Revolt Funds", by TOM O'CONNOR, Staff Writer, who stated that CASTRO had come to Tampa under the auspices of a recently formed society in Tampa known as the 26 July Club, provisionally headed by VICTORIANO MANTEIGA, publisher of a Spanish language newspaper. CASTRO was quoted as stating, "We will try every legal means to oust the tyrant Batista from Cuba, but failing in that we will take to arms." ✓

b6
b7c

SAs [redacted] and [redacted] attended a meeting of the July 26 Club of Tampa, which was held at 3:00 P.M., Sunday, November 27, 1955, at the CIO Hall, 1226 7th Avenue, Tampa. Among the speakers at this meeting was VICTORIANO MANTEIGA, who was introduced as the secretary of the Patriotic Club of July 26 of Tampa. The final speech at this meeting was made by FIDEL CASTRO, who solicited the support of all Cubans who love liberty.

It is noted that on November 29, 1957, the newspaper, "La Gaceta", published a report on the collection which had been taken up at the meeting, which was held two years ago on November 27, 1955, by the July 26 Club of Tampa, at which FIDEL CASTRO spoke. This

MM 105-2374

report showed that a total contribution of \$191.02 was received, and that expenses of \$81.00 had been incurred. This report was signed by VICTORIANO MANTEIGA and FIDEL CASTRO.

The masthead of the December 20, 1957, issue of "La Gaceta" reflects that it is a Spanish newspaper published every Friday at 2015 15th Street, Tampa, Florida. The editor and publisher was listed as VICTORIANO MANTEIGA, and the Business Manager as ROLAND MANTEIGA. *Rolando*
Manteiga

On January 18, 1956, JUAN ORTA CORDOVA was interviewed by Investigator [redacted] at the office of INS, Miami. ORTA identified himself as the President of the Patriotic Club of July 26 of Miami, *Fla* and stated that this group was affiliated with the July 26 Movement in Cuba, which he said was headed by FIDEL CASTRO. He said that there were other such clubs in the United States, including a club located in Tampa, Florida, but that the Miami club had no connection with any other club in the United States. *b6*
b7c

MM T-3, a long time resident of Tampa, Florida, with a wide acquaintance among the Spanish speaking people in that city, advised on February 14, 1956, that he had recently [redacted] *b7D*
He said that MANTEIGA had been named provisional head of the Patriotic Club of July 26 of Tampa, in November, 1955. He said that [redacted] MANTEIGA said that the July 26 Club had had little activity in Tampa, but that there were several people who contributed \$1.00 per week each to the club, which money was going for the support of FIDEL CASTRO and his group in Mexico.

T-3 advised on April 27, 1956, that he had made inquiries among many of his acquaintances of Cuban origin in Tampa, and that nobody seemed to know anything about the Tampa July 26 Club. He stated that in his opinion the club at that time was either non-existent or inactive.

MM 105-2374

VICTORIANO MANTEIGA, 2015 15th Street, Tampa, Florida, editor of "La Gaceta", advised on April 26, 1956, that at that time there was actually no July 26 Club in existence in Tampa. He said that he first met FIDEL CASTRO when CASTRO came to Tampa in November, 1955, and that he was sympathetic with what CASTRO was trying to do just as he was sympathetic to all opposition to the dictatorship of BATISTA in Cuba. MANTEIGA said that CASTRO made the announcement in Tampa that a club was being founded, and that he had wanted to make it appear that he had substantial backing in Tampa, as well as elsewhere in the United States. MANTEIGA stated, however, that the people of Tampa had not responded to CASTRO's appeal sufficiently to establish a club.

MANTEIGA said that he and three other persons met each Sunday at 11:00 A.M. in the office of "La Gaceta", and each contributed \$1.00 per week. He said that the other three persons who had been attending these Sunday meetings were [redacted]

[redacted] He stated that they had no officers with the exception of [redacted]

[redacted] He recalled at the last meeting [redacted] had reported a total collection of \$42.00 which money remained in the treasury. He said that this money was contributed for the support of CASTRO in Mexico.

Juan V. Cheda

MANTEIGA advised that the Tampa group had no contact with any other Patriotic Club of July 26 in the United States, nor with any organized group in Cuba. He said he was aware that there was a large club in Miami, where there was a large colony of Cubans. MANTEIGA said that the president of the Miami club was JUAN CHEDA,

Florida

The May 2, 1957, issue of "Diario Las Americas", a Spanish language daily newspaper published in Miami, Florida, contained an article announcing that a meeting of the July 26 Club of Miami was to be held on May 4, 1957,

MM 105-2374

and that the speakers would include VICTORIANO MANTEIGA, Director of "La Gaceta" of Tampa and president of the July 26 Movement in that city.

MM T-4, a person who was well informed concerning certain Cuban agents, and concerning some counter-revolutionary activities in the Miami area, advised on May 7, 1957, that a meeting of the July 26 Club of Miami was held on May 4, 1957, at 215 N.W. 4th Street, Miami. He said that about 60 persons were present at this meeting, and that among the speakers was VICTORIANO MANTEIGA of Tampa, who commented on the atrocities of the BATISTA regime, and stated that in Cuba there would be no peace until BATISTA disappeared from the scene.

MM T-4 advised on July 15, 1957, that he had attended a meeting of the July 26 Movement of Miami on July 13, 1957. The final speaker of the evening was VICTORIANO MANTEIGA, who stated that two weeks previously a successful meeting had been held in Tampa of the July 26 organization in that city, and that they were uniting because "in union there is strength".

II. STATUS OF JULY 26TH MOVEMENT OF TAMPA, Mid-1957 to December 31, 1958

MM T-1 advised that following the creation of the July 26 Club of Tampa in 1955, and until 1957, there was no "real and positive action inside this organization" because FIDEL CASTRO was still unknown and had not yet received the support of "International Communism". MM T-1 said that on October 15, 1957, in Tampa, the "real revolutionary activities began". "All revolutionary leaders of the different organizations" met, including the July 26 Movement, Authentic Organization (OA), and Revolutionary Directory, and numerous other little groups, at the Clinic of Dr. TRELLES, and formed the Comite de Ayuda a la Liberación de Cuba (Committee to Aid Cuban Liberation) (CALC).

MM 105-2374

File Cuba

File Cuba Representative of ORGANIZATION Authentic

The OA was represented by Dr. TRELLES and ROBERTO DELLOS RIOS, the Revolutionary Directory by VICTOR FERRE LOPEZ and MARIO ENCINOSA, and the July 26 Movement by RAUL VIANA, ANIBAL VELAS and Dr. FRANCISCO GARCIA MENENDEZ.

Representatives of July 26 movement Tampa Fla

MM T-1 said that CALC "did a remarkable job -- from selling bonds to the sending of medicines, armaments, distribution of propaganda for FIDEL CASTRO, and the aid of Cuban Communists persecuted by the BATIS regime. Dr. TRELLES' Clinic was the center of operation of this organization."

MM T-1 also alleged

[Redacted]

b6
b7C
b7D

ment

York City, Fla

MM T-5,

[Redacted]

advised on December 7, 1950, that

[Redacted] Florida, and that [Redacted] was patronized by many Communists. MM T-5 said that [Redacted] was at one time an [Redacted]

b6
b7C
b7D

[Redacted] in Tampa, Florida, in 1948.

The newspaper, "La Gaceta", issue of June 28, 1957, reported that a meeting of Revolutionary Unity had been held the past Sunday at the Flagler Theater in Miami, Florida. This article related that the Tampa delegation to this meeting was composed of VICTORIANO MANTEIGA, FLORENTINO SANTOS, RAUL VILLAMIA, CARLOS CARBONELL, and his son, and ENRIQUE SOMEILLAN.

File

MM 105-2374

The "Tampa Tribune" issue of July 1, 1957, contained an article captioned "BATISTA Foes Rally Here, Aid Rebels".

It was stated that "some 200 Tampans of Latin extraction and a scattering of Cuban exiles-heard speakers whip up support here yesterday for Cuban Revolutionary Leader FIDEL CASTRO, who is opposing the regime of President BATISTA." The article stated that JACINTO VASQUEZ, President of the July 26 Club of Miami, and VICTORIANO MANEIGA, who was described as the Tampa leader for CASTRO, addressed the meeting. The article stated that MANEIGA had said that the Cuban people were asking citizens of the United States "only for fair play and not intervention." It was stated that the audience contributed an estimated \$250.00 to help CASTRO. (u) b6

On July 16, 1957, MM T-3 advised that he had not attended the meeting of June 30, 1957 in Tampa, but that he had learned from [redacted] that the main purpose of the meeting was to stimulate interest in behalf of CASTRO and to collect funds. b6
b7C

MM T-3 said that this meeting was the first activity conducted on behalf of CASTRO in Tampa in 1957, and that he knew of no activity on the part of the July 26 Movement Club in Tampa.

It is noted that on June 24, 1957, VICTORIANO MANEIGA advised SA [redacted] that a meeting was to be held by supporters of FIDEL CASTRO in Tampa on June 30, 1957, and that this activity would be the first such activity in Tampa since CASTRO, himself, had spoken there. MANEIGA stated that in reality there was no July 26 Movement Club in existence in Tampa due to public apathy.

MM T-3 advised on July 18, 1957, that the July 26 Club of Tampa had been active in distributing leaflets on that date at the cigar factory of Perfecto Garcia and

MM 105-2374

Brothers Company. He said that these leaflets appealed to those workers who had "helped the Spanish Republic when it was attacked by International Fascism" to assist the youth of Cuba and FIDEL CASTRO in returning Cuba to "its liberty". The leaflet was signed "For the 26th of July Club of Tampa, VICTORIANO MANTEIGA, President, RAUL VILLAMIA, Secretary," and was dated July, 1957.

The "Tampa Tribune" issue of July 26, 1957, contained an article captioned "Cubans Place Pickets at Consulate". This article stated that "members of the July 26 Club, sympathizers with the Cuban revolutionists, yesterday set up picket lines in front of the Cuban Consulate Office in downtown Tampa".

The article related that VICTORIANO MANTEIGA, President of the July 26 Club, had stated that members were also collecting donations throughout Tampa to assist some 50 or 60 Cuban youths exiled in Tampa and unable to get work. The article stated that the picketers carried placards attacking BATISTA, and identifying themselves as July 26 Club members.

The September 25, 1957, issue of "Diario Las Americas", in its column entitled "Reloj", published a letter from VICTORIANO MANTEIGA in which MANTEIGA stated that he was then the president of the July 26 Movement of Tampa, and that he had been appointed by FIDEL CASTRO personally.

On October 7, 1957, [redacted] previously mentioned, made available to SA [redacted] a leaflet which stated as follows: "Join the 'July 26th Movement' by becoming a member of the 'July 26th Patriotic Club of Tampa'." This leaflet stated that in order to join this club people could apply at the newspaper "La Gaceta" at 10th Avenue and 15th Street in Ybor City, and that anyone who wished to contribute financial assistance could do so by mailing their contribution to that address.

Spanish Newspaper

b6
b7c

KM 105-2374

[redacted] stated that the above-mentioned leaflet was one of a number which had been distributed in Miami by persons unknown to him.

On December 17, 1957, [redacted]

[redacted] advised SA [redacted] that the Central Committee for Revolutionary Unity had been formed in October, 1957, in Tampa by from 10 to 15 persons, members of several different organizations opposed to the administration of BATISTA in Cuba. He said that the purpose of the Committee was to give an "aspect of unity" to the Cubans opposed to BATISTA. [redacted] said that he did not remember the names of all who participated in the formation of this Committee, but that among them were [redacted] VICTOR FERRER, ANIBAL VELAZ, RODOLFO VAZQUEZ, and RAUL VIANA.

[redacted] participated in the founding of the Committee as an individual, but not as a representative of any group.

b6
b7c

He said that [redacted]

[redacted] this group then consisted of from 10 to 12 members who meet at 8:00 P.M. each Monday at 1924 East Broadway, Tampa. He stated that these were essentially the same persons who formed the Committee for Revolutionary Unity, with the exception of [redacted] and VICTOR FERRER, neither of whom belonged to the 26 of July Movement. [redacted] stated that VICTORIANO MANTEIGA, who calls himself President of the 26th of July Movement, was the President when the organization was first formed about two years ago. [redacted] stated, however, that the organization had been completely inactive, and that he, himself, had never personally met MANTEIGA. He also identified [redacted] and [redacted] as other members of the July, 26th Movement.

It is noted that the "Diario Las Americas" issue of October 10, 1957, carried an announcement in the

MM 105-2374

column "Reloj" that a ~~Committee~~ Committee for Revolutionary Unity had been established in Tampa, Florida, with VICTOR FERRER, Dr. FRANCISCO GARCIA MENENDEZ, and Dr. JORGE TRELLES as officers. It was stated that the purpose of this Committee was to unite the various factions of the Revolutionary Movement.

On November 18, 1957, VICTORIANO MANTEIGA was interviewed at his office, 2015 15th Street, Tampa, by SA [redacted] stated that he continued to act as President of the 26 of July Movement in Tampa, although the Movement had been split in two. He stated that the other group was headed by Dr. FRANCISCO GARCIA MENENDEZ, ANIBAL VELAZ and RAUL VIANA. MANTEIGA said that he had no respect for and did not wish to associate with the other group as their purpose was only to create "a fuss". MANTEIGA said that he and his associates in the July 26 Movement had had no part in the Tampa Committee for Revolutionary Unity, but that the GARCIA MENENDEZ faction had joined that Committee.

On January 17, 1958, VICTOR FERRER LOPEZ, [redacted] Tampa, advised SA [redacted] that he, as head of the Revolutionary Directory in Tampa, had participated in the founding of the Central Committee for Revolutionary Unity in October, 1957. He said that this Committee was composed of representatives from the various revolutionary groups, and that the faction representing the 26 of July Club consisted of Dr. GARCIA MENENDEZ, RAUL VIANA and Dr. VIRGILIO JACAS. FERRER stated that the sole purpose of the Committee was for the dissemination of propaganda. He said that the original manifesto of the Committee was published in book form and printed in a book shop located on 15th Street opposite the Gonzalez Clinic. He said that he believed the arrangements for the printing had been handled by [redacted] a member of the 26 of July Club, and [redacted] FERRER also stated that other leaflets had been published for the Committee by the ABC Printing Company located in the 1700 block on 28th Avenue. He said that he recalled one of these leaflets had called on the people in Tampa to unite in

b6
b7c

MM 105-2374

opposition to BATISTA, and that another asked people to cooperate with the Committee in the sale of bonds.

On January 24, 1958, Dr. JORGE TRELLES, owner and operator of the Trelles Clinic, 1612 Eighth Avenue, Tampa, advised SA [redacted] that he had assisted in the founding of the Central Committee for Revolutionary Unity, and that he had actually written the original manifesto. He said that in addition to the Authentic Organization, of which he said he was a member, the Committee was represented by members of the 26th of July Club and the Revolutionary Directory.

b6
b7c

On February 13, 1958, VICTORIANO MANTIEGA was reinterviewed by SA [redacted] at which time he stated that he had never taken part in the Committee for Revolutionary Unity, and that it was his belief that the Committee had been specifically repudiated by FIDEL CASTRO and had died. MANTIEGA said that he had resigned as President of the July 26 Movement of Tampa, and that he no longer was attending any meetings. He stated that he was personally disgusted with the so-called revolutionary activities because everyone interested had been soliciting contributions individually, and each wanted to be head of his own organization. He said that as a result the people of Tampa had no confidence in any of these organizations.

"La Gaceta" issue of January 17, 1958, on page 11 published a letter addressed to the director of that paper, which stated that "we are sending you the following declarations formulated by the July 26 Revolutionary Club of Tampa". This letter goes on to state that the decisions of the National Director of the July 26 Movement are to be followed without discussion or argument. It asked that all members and sympathizers who were not then in Cuba shedding blood to assist the Movement economically. This letter was signed by the Executive Committee of the 26 of July Revolutionary Movement of Tampa, and listed Dr. EDUARDO V. MIJARES PUJALS as President and

MM 105-2374

July 26 Club Tampa
VIRGILIO JACAS ~~QUINTANA~~ as Secretary General. In a comment *Florida* on the letter, "La Gaceta" stated that it applauded statements of the Executive Committee representing the July 26 Club of Tampa, and mentioned that the director of "La Gaceta" had presided over that club until a few weeks ago.

On February 12, 1958, VICTOR FERRER LOPEZ was recontacted by SA [] and advised that at that time there was no organized revolutionary activity in Tampa due to the dissention within the July 26 Movement. He said that one club headed by Dr. GARCIA MENENDEZ had broken off from the original organization, and that to that date all efforts to resolve their differences had been unsuccessful.

On March 11, 1958, MM T-3 advised that in recent weeks the activity of the July 26 Movement in Tampa had come to a standstill with the exception of the distribution on March 8, 1958, of some circulars over the signature of the "Directing Committee, Patriotic Club of July 26 of Tampa", which appealed for contributions. b6
b7C

On December 31, 1958, MM T-3 advised that the July 26 Patriotic Club of Tampa had made plans to stage a demonstration on that date at 15th Street and 10th Avenue in Tampa to protest the bombing of the civilian population of Cuba by BATISTA.

At approximately 4:30 P.M., on December 31, 1958, SA [] observed a group of eight pickets parading back and forth on the sidewalk in front of the U.S. Post Office Building in downtown Tampa. These individuals carried placards identifying themselves as representatives of the July 26 Patriotic Club of Tampa, and protesting the bombing of Cuban civilians by Batista.

MM 105-2374

III. STATUS OF THE JULY 26TH MOVEMENT OF TAMPA
January 1, 1959, to May 31, 1960

MM T-1 advised that following the fall of the BATISTA regime "a number of figures of the July 26 Movement of Tampa were given important positions in the new Communist regime." MM T-1 also advised that the CALC was dissolved by order of CASTRO, and that the Patriotic Club of July 26 came back into existence with the following officers:

Tampa, Florida
President - FELIPE ~~VIMENEZ~~ "Indio"
Vice President - MANUEL MIGUEL
Secretary - RAUL VILLAMIA
Treasurer - GUSTAVO MORAN
Head of Publicity - RAMON ~~SANCHEZ~~

Fla
cu. 22

According to MM T-1, however, "the president of this organization is VICTORIANO MANTEIGA, although he appears retired from political activity."

It is noted that the government of FULGENCIO BATISTA was overthrown on January 1, 1959, and the forces of FIDEL CASTRO assumed control of the Cuban Government.

On January 3, 1959, Inspector [redacted] Chief of the Tampa Police Department Detective Bureau, advised SA STEPHEN J. LABADIE that on January 2, 1959, Tampa leaders of the July 26 Movement had been notified by the police that continuous police protection was being provided for the Cuban Consulate until such time as there had been a peaceful change in the Consulate. He said that the leaders of the July 26 Movement, RAUL VILLAMIA and GUS ~~RANDCLIFFE~~, had agreed that they would take over the Consulate without force or firearms.

b6
b7c

Tampa, Fla.

MM 105-2374

The "Tampa Tribune" for January 5, 1959, contained an article and photographs under the caption "Tampa Followers of Castro Make Peaceful Invasion of Cuban Consulate Here". The article indicated that RAUL VILLAMIA, described as the local CASTRO leader, and GUILLERMO BOLIVAR had reached an agreement on joint occupancy of the Cuban Consulate until such time as the new Consul General had been named. The photograph accompanying this article showed four individuals at the Consulate, and described them as FIDEL CASTRO supporters. These four were identified as RAUL VILLAMIA, JUAN PEREZ, CARLOS SUREDA and JUAN TORRES.

The "Tampa Tribune" for January 21, 1959, contained an article captioned "Two Rivals Still Share Cuban Consul Office Here". The article said that the Cuban Consulate in Tampa was still suspended between CASTRO and BATISTA, and that after a great deal of argument, but no violence, it had been agreed that the incumbent, GUILLERMO BOLIVAR, and RAUL VILLAMIA, representative of the 26 of July Group, would continue sharing the office until official word had been received from Cuba.

The April 8, 1959, issue of "Diario Las Americas" contained an article captioned "Cuba and the United States". This article consisted of a letter to that paper from the "Committee to Aid the Cuban Revolution" located in Tampa, Florida. This letter defended the Cuban revolution and CASTRO as an example of liberty, justice and dignity, and took exception to attacks on Cuba by the press in the United States and Latin America. This letter was signed for the Committee by the following:

Dr. M. AGUERO, President
RAUL MORAN, Vice-President
ROBERTO DE LOS RIOS, Secretary
ENRIQUE MENDOZA, Organizing Secretary
ENRIQUE SOMEILLAN, Publicity
FELIPE JIMENEZ, member at large
FLORENTINO SANCHEZ, member at large
MARTA MENDOZA, member at large, and
JOE ALVAREZ, member at large.

MM 105-2374

It is noted that MM T-1 furnished a "List of Members of the Communist Cell Inside 'The 26th of July Movement Club' of Tampa, Florida" In this list, which is set forth, beginning on page 20 of this report, MMT-1 has set forth the names of several of the above-mentioned individuals. He describes ENRIQUE MENDOZA, MARTA MENDOZA, and JOE ALVAREZ as CP members, and FELIPE JIMENEZ as "Head of the D. I. E. R. in Tampa". DIER is the Department of Investigations of the Revolutionary Army.

MM 105-2374

"La Gaceta" issue of August 7, 1959, contained an article reporting that a meeting of the July 26 Patriotic Club of Tampa took place on the preceding Tuesday. This article mentioned that the club had accepted the resignation of one member, and dissolved the membership of another.

The issue stated that the club was disposed to cooperate with those Cuban groups which accept with absolute sincerity the postulates of the revolution.

It was indicated that the information regarding this meeting had been received from [redacted]
[redacted]

The October 16, 1959, issue of "La Gaceta" carried an article reflecting that a meeting of the 26 of July Movement of Tampa had been held the previous Tuesday. The article related that a committee of the club had advised that they had carried out the agreement to plant rose bushes at Jose Marti Park, and that "Live Free Cuba" posters had been distributed in various parts of the city. It was stated that two new members who had previously been investigated, had joined the group. The information had been furnished by [redacted]
[redacted]

b6
b7c

Cuba
File

The February 26, 1960, issue of "La Gaceta" contained an article captioned "Secretary of July 26 Movement Miami Pays A Visit". The article related that JUAN RODRIGUEZ, the secretary of the July 26 Movement of Miami, had recently visited the office of "La Gaceta" and the headquarters of the July 26 Movement in Tampa. It was stated that he attended a meeting at the Tampa Office of the July 26 Movement, and that he had made a speech to the members. The article related that comments regarding the speech of RODRIGUEZ were also made by the President, VICTORIANO MANTEIGA.

MM 105-2374

On May 2, 1960, [redacted] INS, Miami, made available lists of passengers aboard Cubana Airlines Flights 809 and 811 of April 29, 1960, and Flight 811 of April 30, 1960. These flights were all destined to Havana. Included in the names which appear on these lists was that of VICTORIANO MANTEIGA, [redacted] Tampa, a United States citizen.

It is noted that on April 25, 1960, MM T-6, a person who is acquainted with numerous Cubans in the Miami area, advised that the 26 of July Club of Miami, chartered several Cubana Airlines flights to Havana on April 29, 1960, and that the individuals making these flights were going to Havana to attend the May Day Celebration there.

MM T-7, a Cuban who [redacted] [redacted] advised on November 29, 1960, that the July 26 Club of Tampa and the July 26 Club of Miami have never had a close affiliation. He said that the Tampa club's principal activities in the past have consisted of pro-CASTRO propaganda and fund collecting, but that this club has never been highly regarded by members of the Miami 26 of July Club. He said that this is due to the fact that the Tampa club has been the victim of frequent disagreements among club members, as well as with the Cuban Consulate in Tampa. As an example, MM T-7 cited a situation which developed in February, 1960, in connection with a celebration planned by the 26 of July Club in Tampa, for February 28, 1960, to commemorate the Cuban hero, [redacted] RENE DECHARD, the Cuban Consul in Tampa, would only agree to participate in this celebration if the July 26 Club of Tampa did not. MM T-7 said that he [redacted]

b6
b7C
b7D

[redacted] He said that he believes that MANTEIGA is still president of the July 26 Club of Tampa.

MM 105-2374

IV. ALLEGED COMMUNIST INFILTRATION OF THE
JULY 26TH MOVEMENT OF TAMPA

MM T-1 furnished the following list, which he described as a "list of members of the Communist cell inside the '26th of July Movement Club' of Tampa, Florida."

b6
b7C
b7D

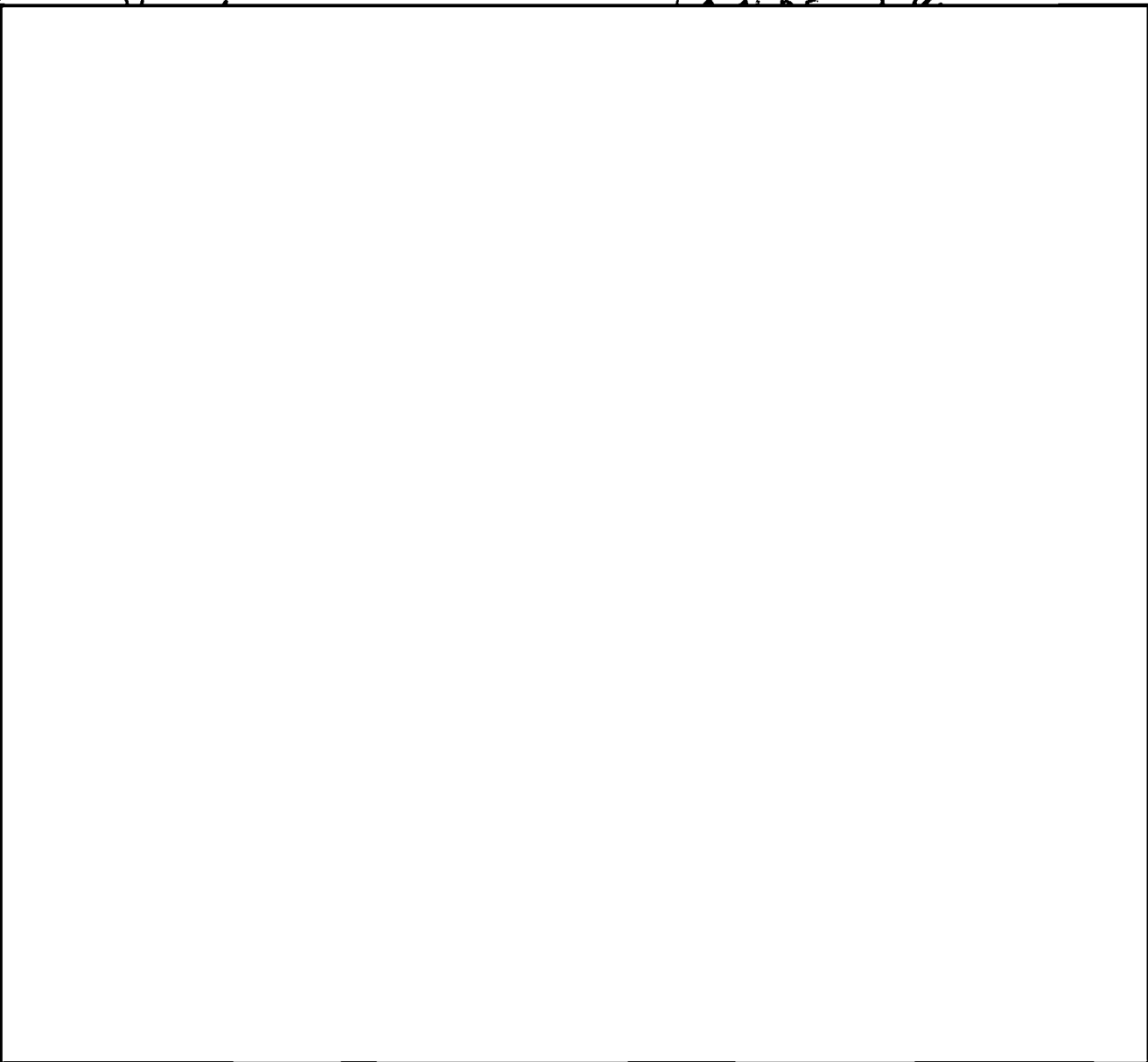

MM 105-2374

b6
b7C
b7D

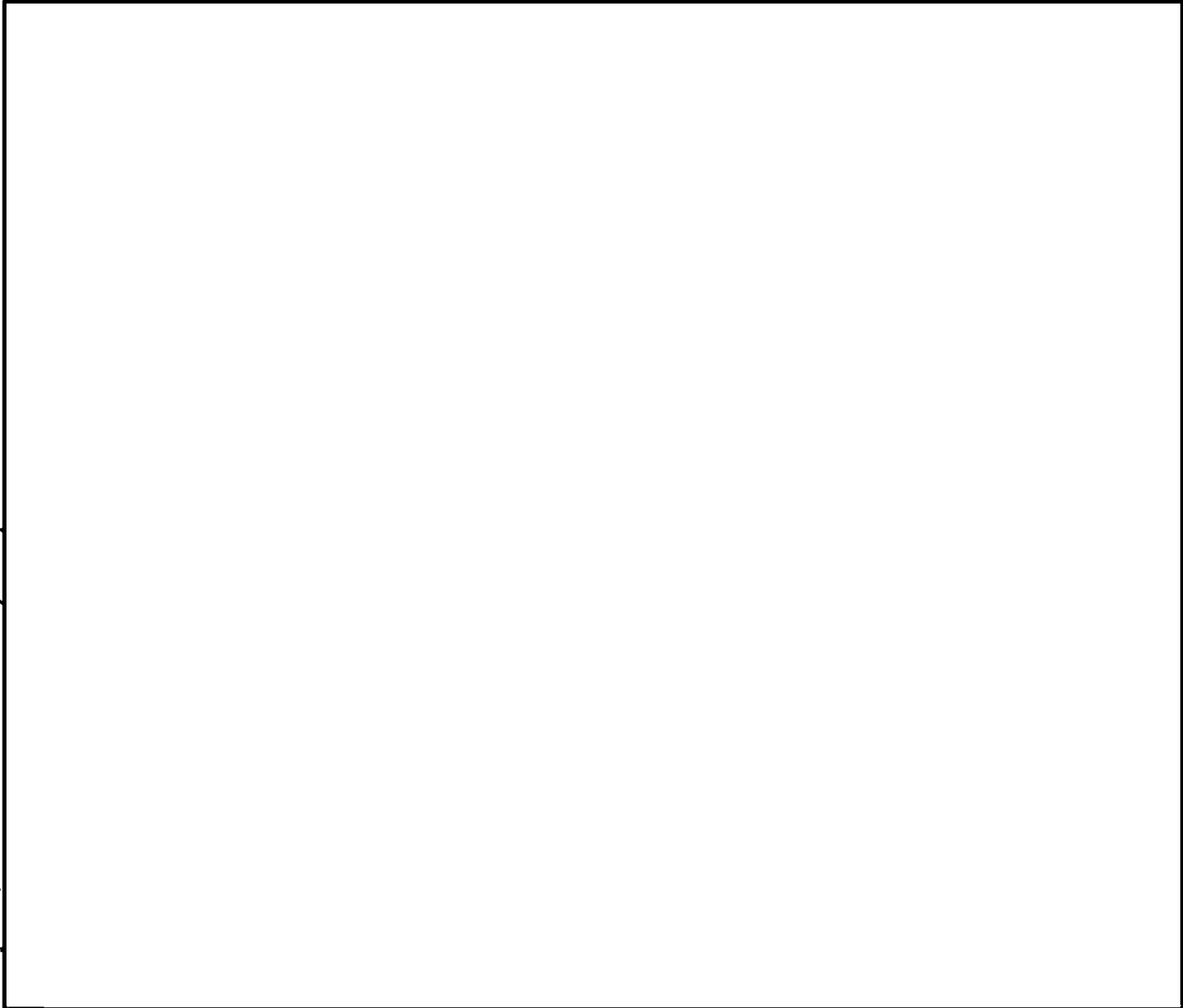

*Number of Communist Cell
inside July 26 - Movement -
Tampa, Florida*

Regarding [redacted] MM T-8 advised in 1945 that the name [redacted] Florida, appeared on a list of subscribers to the "Worker". It was indicated that [redacted] subscription expired as of May, 1944.

Regarding [redacted] it is noted that the September, 1957, issue of "La Prensa", a Spanish language daily newspaper published in New York City, contained an article on page two captioned "July 26th Movement is Unified Here." This article stated that on September 8,

b6
b7C
b7D

MM 105-2374

1957, the organizations known as the Democratic Labor Committee, the Cuban Civic Committee, and the Orthodox Committee had been united to form a single organization to be known as the July 26 Revolutionary Movement. The article set forth a list of individuals who were elected as secretaries of the new organization, and included in this list was the name [redacted]

b6
b7c

[redacted] It is not known whether this [redacted] is identical to the person mentioned by MM T-1.

Regarding [redacted] MM T-9 advised on July 9, 1960, that the name [redacted] was then listed as a member of the July 26 Club of Miami.

Regarding [redacted] it is noted that MM T-15 advised on February 6, 1955, that on December 13, 1954, information had been received that [redacted] Florida, had been a subscriber to the "Proletarian News", but that his subscription had lapsed.

The masthead of the "Proletarian News" states that it is the official organ of the Proletarian Party of American (PPA).

The PPA has been designated by the Attorney General of the United States pursuant to Executive Order 10450.

Regarding [redacted] it is noted that MM T-10, a person who is familiar with some CP activities and personalities in the Tampa area, advised in early 1945 that [redacted] Tampa, was then a member of the Tampa section of the National Council of American Soviet Friendship (NCASF).

The NCASF has been designated by the Attorney General of the United States pursuant to Executive Order 10450.

MM 105-2374

Regarding [redacted] it is noted that MM T-11, a confidential source abroad, advised on July 26, 1944.

[redacted]

Regarding [redacted] it is noted that on October 12, 1949, MM T-12 made available information reflecting that [redacted] Tampa, was listed as a subscriber to "The Worker" in 1949.

"The Worker" is an East Coast Communist weekly newspaper.

Regarding VICTORIANO MANTEIGA, it is noted that the Office of Naval Intelligence, 6th Naval District, by letter dated August, 1940, furnished a list of persons who were suspected of being Communists. Included among the names appearing on this list was VICTORIANO MANTEIGA, [redacted] Florida. MANTEIGA was described as the publisher of a Spanish newspaper and as a rabid Communist, who had kept the Spanish element in Tampa in a turmoil for years. It was stated he had been the leader of a group of radicals who were active in obtaining funds for the Loyalists in Spain, and that [redacted]

b6
b7c

[redacted] It was stated that at that time he was continuing to agitate among the Spanish element in Tampa.

MM T-13 advised on May 20, 1959, that as of February and March, 1958, there were 36 CP members in the State of Florida, and that of those 36, there were seven CP members in Tampa.

On March 10, 1960, MM T-14 advised that at that time there was no CP activity as such in Florida, although there were isolated groups and individuals who from time to time would contribute to the CP, but not as a part of any organized movement or club.

It is noted MM T-1 stated all officers and members of July 26 Club of Tampa "are active CP members or agents of CASTRO's G-2 Organization".

MM 105-2374

MM T-7 advised on November 29, 1960, that he was in possession of no information indicating that the members of the July 26 Club of Tampa were actually members of the CP or that they were operating as agents of DIER (Department of Investigations of the Revolutionary Army).

V. STATUS UNDER THE FOREIGN AGENTS REGISTRATION ACT OF 1948, AS AMENDED

On May 8, 1957, [redacted] [redacted] Registration Section, Internal Security Division, Department of Justice, Washington, D.C., made available for review by SA LIONEL E. BELANGER, registration statement number 998 filed on February 6, 1957, by the Patriotic Club of July 26 of Miami, Florida, pursuant to Section 2 of the Foreign Agents Registration Act of 1938, as amended. The following notation appeared on this statement:

"All answers apply to former activities of registrant - inactive since August 1, 1956."

According to this statement, the organization was created in approximately November, 1955, in Florida, and was a voluntary group with approximately 100 members in the United States. The address of the principal office was 2334 N.W. 7th Street, Miami, and JUAN V. CHEDA was listed as the person in charge of the office. The names of the foreign principals of the registrant were as follows:

1. Underground: Nameless groups in Cuba sympathetic to restoring liberty and constitutional government to Cuba.
2. FIDEL CASTRO RUZ, address unknown.

This statement also listed three branch or local units of the registrant together with the name of the person in charge. One of these three was the Patriotic Club of July 26 of Tampa, Florida, and VICTORIANO MANTEIGA, [redacted] [redacted] Tampa, Florida, was listed as President.

MM 105-2374

On November 10, 1959, the Registration Section of the Department of Justice advised that information received indicated that the Patriotic Club of July 26 of Miami had suspended operations as of January, 1959, and that the leaders had returned to Cuba. Therefore, the registration number 998 of the club was being marked terminated as of January 1, 1959, the date of the change of government in Cuba.



UNITED STATES DEPARTMENT OF JUSTICE
FEDERAL BUREAU OF INVESTIGATION

In Reply, Please Refer to
File No.

Miami, Florida

105-2374

DEC 5 - 1960

RE: JULY 26TH MOVEMENT,
TAMPA, FLORIDA

Reference is made to the report of Special Agent [redacted] dated and captioned as above at Miami, Florida.

All sources mentioned in referenced report have furnished reliable information in the past with the exception of the following:

b6
b7c

MM T-7, a source with whom insufficient contact has been had to make a determination as to reliability, but who is in an excellent position to furnish reliable information.

MM T-8, MM T-9 and MM T-13, who were in a position to obtain the information furnished.

PROPERTY OF FBI - This document is the property of the FBI and is loaned to your agency; neither it nor its contents is to be distributed outside the agency to which loaned.

ALL INFORMATION CONTAINED
HEREIN IS UNCLASSIFIED
DATE 02-22-2010 BY UC 60322 LP/STP/SZ

UNITED STATES GOVERNMENT

Memorandum
FD-205

TO: Director, FBI (File 97-4455-2) DATE: 12/5/60

FROM: *ROT* SAC, Miami (File 105-2374)

SUBJECT: JULY 26 MOVEMENT, TAMPA, FLA.
IS- CUBA; RA - CURA

This case will be delinquent.

Date of Bureau deadline: TO REACH BUREAU 12/6/60

Reason for the delinquency: REPORT CORRECTED + READY
FOR MULTI-LITH 12/3/60. MULTI-LITH MACHINE
BROKE DOWN. REPORT WILL BE ASSEMBLED + MAILED
ON 12/6/60

Date the Report or necessary communication will reach the
Bureau: 12/7/60

AEC zone designation, e.g., OR, CH, etc.:
(This applies only to 116 cases.)

No admin. action recommended.

380

97-4455

ANAT. ~~INT~~ SEC. *CA*

UNITED STATES GOVERNMENT

Memorandum
FD-205

ALL INFORMATION CONTAINED
HEREIN IS UNCLASSIFIED
DATE 02-22-2010 BY UC 60322 LP/STP/SZ

TO : Director, FBI (File 97-4455-2) DATE: 11/30/60

FROM : *RST* SAC, Miami (File 105-2374)

SUBJECT: JULY 26 MOVEMENT, TAMPA, FLORIDA
RA - CUBA ; IS - CUBA

This case will be delinquent.

Date of Bureau deadline: 12/1/60

Reason for the delinquency:

NECESSITY TO OBTAIN INFORMANT EVALUATION INFORMATION
AND INTERVIEW A. GONZALEZ, PAST PRESIDENT 7/26 CLUB, MIAMI.
REPORT HAS BEEN DICTATED, AWAITING TRANSCRIPTION.
Date the Report or necessary communication will reach the
Bureau: 12/6/60.

AEC zone designation, e.g., OR, CH, etc.:
(This applies only to 116 cases.)

No admin. action recommended.
Hastell

SW 97-4455

~~CONFIDENTIAL~~

EXEMPTED FROM AUTOMATIC
DECLASSIFICATION
AUTHORITY DERIVED FROM:
FBI AUTOMATIC DECLASSIFICATION GUIDE
EXEMPTION CODE 25X(1-HUMAN/AAG)
DATE 02-22-2010

FEDERAL BUREAU OF INVESTIGATION
U. S. DEPARTMENT OF JUSTICE
COMMUNICATIONS SECTION



- Mr. Tolson _____
- Mr. Mohr _____
- Mr. Parsons _____
- Mr. Belmont _____
- Mr. Callahan _____
- Mr. DeLoach _____
- Mr. Malone _____
- Mr. McCallister _____
- Mr. Rosen _____
- Mr. Tavel _____
- Mr. Trotter _____
- Mr. Tele. Room _____
- Miss Holmes _____
- Miss Gandy _____

NOV 16 1960

TELETYPE

103489

ALL INFORMATION CONTAINED
HEREIN IS UNCLASSIFIED EXCEPT
WHERE SHOWN OTHERWISE

URGENT 11-16-60 6-90 P RHD

TO DIRECTOR, FBI /105-84576/ AND SACS, NEW YORK /105-39468/ AND

MIAMI /105-2747/

NEW YORK VIA WASHINGTON

FROM SAC, TAMPA /105- NEW/ 1 P
July Twenty-Six Club, Tampa Fla.

JOSE VAZQUEZ BLANCO, AKA, IS DASH CUBA, RE MIAMI TEL TODAY.

TAMPA IN AIRTEL DATED SIXTEENTH INSTANT BUREAU, AND ABOVE OFFICES
WERE FURNISHED INFO RECEIVED EVENING NOVEMBER FOURTEEN FROM PSI

[REDACTED] TAMPA, THAT VAZQUEZ IS IN MAIMI AND EXPECTS TO
COME TO TAMPA THURSDAY NOVEMBER SEVENTEENTH WITH CONSUL GENERAL
EDELBERTO DIAZ ALVAREZ. [REDACTED] HE WANTS TO MEET

PRO CASTRO PEOPLE IN TAMPA AND FIND OUT WHY TWENTY SIXTH OF JULY

MOVEMENT IN TAMPA IS DEAD. HE EXPECTS TO BE IN TAMPA TWO DAYS

AND WILL RETURN TO CUBA SATURDAY OR SUNDAY. [REDACTED] DESCRIBED

VAZQUEZ AS INSPECTOR OF ALL CONSULATES IN UNITED STATES AND EMPLOYER

OF CONSULATE GENERAL IN NEW YORK BUT SAID HE WILL NOT RETURN TO

NEW YORK FROM CUBA, EXPECTS INSTEAD TO BE SENT TO SOUTH AMERICA

TO ORGANIZE ANTI DASH AMERICAN AND PRO DASH CASTRO MOVEMENTS.

[REDACTED] SAID HE ALERTED [REDACTED] WHO HAS [REDACTED]

END N ACK PLS

WA 6-49 PM OK FBI WA JDS

52 DEC 6 1960
FBI COURHR

DISCV

~~CONFIDENTIAL~~

119-7-4455

NOT RECORDED

180 NOV 30 1960

12-1

RELAYED

NY

ORIGINAL FILED IN 105-84576-413

b1

b6

b7C

b7D

FBI

ALL INFORMATION CONTAINED
HEREIN IS UNCLASSIFIED
DATE 02-22-2010 BY UC 60322 LP/STP/SZ

Date: 12/5/60

Transmit the following in _____
(Type in plain text or code)

Via AIRTEL AIRMAIL
(Priority or Method of Mailing)

TO: DIRECTOR, FBI
FROM: SAC, MIAMI (105-2374)
①
JULY 26TH MOVEMENT,
TAMPA, FLORIDA
IS - CUBA; RA - CUBA

SD/ser

5-1

[Handwritten signature]

Re Bureau airtel to Tampa 11/10/60, and report of SA [redacted] dated 12/5/60 at Miami.

Based on a review of all pertinent references, as well as interview with [redacted] there has apparently been only limited liaison between the Tampa and Miami Clubs of the July 26th Movement in the past. Furthermore, there is no reason to believe that the activity of the Tampa Club in the field of propaganda and fund collective, have been at all extensive.

b6
b7C
b7D

It is noted that [redacted] in his report, follows the customary procedure utilized by many [redacted]

[redacted] While it is not being implied that the information furnished by [redacted] is totally inaccurate, it does appear that in many instances [redacted] has made these allegations based on the premise that to support CASTRO is to indicate Communist affiliation or sympathy. It would appear that [redacted] information relating

[Handwritten mark]

Wick

- RUC
- 3 - Bureau (RM) (AM)
- 2 - Tampa (RM) (AM)
- 1 - Miami

REC-33

97-4455-5
97-3244

329

EX-111

15 DEC 7 1960

JAKES

WMD:sah

Approved: *[Signature]*
(6)
Special Agent in Charge

Sent _____

[Handwritten signatures and stamps]

JAN 3 1961

DEC 5 1960

MM 105-2374

to the formation and early development of the Tampa July 26th Club is essentially accurate as to the individuals involved and the times mentioned.

Based on information available in Miami files, it has not been possible to substantiate allegations of CP membership or sympathy on the part of most of those mentioned.

A review of Miami file 100-800, which file covered the CP of Tampa, does not support [redacted] allegations of CP membership. As of February and March, 1958, there were only seven members of the CP, USA, known to be in Tampa. Based on previous descriptive data obtained from CP registrations, it was believed that the seven CP members were as follows:

- 1.
- 2.
- 3.
- 4.
- 5.
- 6.
- 7.

[redacted]

b6
b7C
b7D

The only one of the six names mentioned above which may be identical with any of those mentioned by [redacted] is the name [redacted] possibly identical with [redacted]

The entire file re [redacted] was transferred from Miami to Tampa, and no additional identifying information regarding [redacted] was located in Miami files.

It, therefore, seems possible that [redacted] for reasons of his own, has given an exaggerated version of the July 26 Club of Tampa. It is known that [redacted]

MM 105-2374

b7D

Miami will remain alert for any pertinent information relating to the Tampa 26th of July Movement, and same will be promptly furnished to the Tampa Office.

~~CONFIDENTIAL~~



UNITED STATES GOVERNMENT

Memorandum

TO : DIRECTOR, FBI (~~105-82024~~)

DATE: 12/8/60

FROM : SAC, TAMPA (97-2)

EXEMPTED FROM AUTOMATIC
DECLASSIFICATION
AUTHORITY DERIVED FROM:
FBI AUTOMATIC DECLASSIFICATION GUIDE
EXEMPTION CODE 25X(1-HUMAN/AAG)
DATE 02-22-2010

SUBJECT: JULY 26th MOVEMENT
TAMPA, FLORIDA
REGISTRATION ACT-CUBA
IS-CUBA

ALL INFORMATION CONTAINED
HEREIN IS UNCLASSIFIED EXCEPT
WHERE SHOWN OTHERWISE

b1

Bureau authority is requested for use of following
Characterization of captioned organization. The first
source referred to in the second paragraph below is PSI

The other source mentioned is PSI

(C)

According to an editorial appearing Sept. 30, 1960, in La Gaceta, a Spanish Language weekly newspaper published at Tampa, Florida, by VICTORIANO MANTEIGA, the 26th of July Club of Tampa was founded November 27, 1955, in Tampa in the presence of Dr. FIDEL CASTRO, and while CASTRO was fighting in Cuba, issued propaganda and collected donations for the revolutionaries. According to other articles appearing in this newspaper and source in a position to know, MANTEIGA was president and directed this Club, variously known as the 26th of July Club, 26th of July Movement and other variations and translations, for a number of years. The Club maintains headquarters at 1318 9th Street, Tampa.

b6
b7C
b7D

A source in a position to know advised that after CASTRO gained power in Cuba, a number of persons active in the Tampa 26th of July Club returned to Cuba and assumed positions of varying importance in the CASTRO government. Thereafter, according to another source who has furnished reliable information in the past, the Tampa Club diminished in size, importance and activity, and the only activity noted in recent months has been the publication in La Gaceta of releases by

[Redacted block]

2-Bureau
2-Tampa
(1-100-49)
RSC;jap
(4)

MAILED 5
DEC 19 1960
COMM-FBI

REC-30

97-4455-6
~~97-3211-327~~

10 DEC 12 1960

APPROVED

DATE

12/19/60

SMB/PLC
-102

NATC SEC

MAIL ROOM
JAN 3 1961

~~CONFIDENTIAL~~

~~CONFIDENTIAL~~

No deletion per OGA letter dated
3/1/2010

FEDERAL BUREAU OF INVESTIGATION

Reporting Office TAMPA	Office of Origin TAMPA	Date 12/10/60	Investigative Period 11/14-12/8/60
TITLE OF CASE JULY 26TH MOVEMENT, TAMPA, FLORIDA		Report made by <div style="border: 1px solid black; width: 150px; height: 20px;"></div>	Typed By: JN
		CHARACTER OF CASE RA - CUBA IS - CUBA	

b6
b7C

~~EXEMPT~~
REFERENCES: Bureau airtel to Tampa 11/10/60.
Report of SA , Miami, 12/5/60.

- P -

LEADS

TAMPA

AT TAMPA, FLORIDA

1. Endeavor to locate bank account of subject organization and review same for pertinent information.
2. Follow and report activities of subject organization.
3. If organization continues to function, obtain further identifying data re its members.

ALL INFORMATION CONTAINED
HEREIN IS UNCLASSIFIED EXCEPT
WHERE SHOWN OTHERWISE

EXEMPTED FROM AUTOMATIC
DECLASSIFICATION
AUTHORITY DERIVED FROM:
FBI AUTOMATIC DECLASSIFICATION GUIDE
EXEMPTION CODE 25X(1 - HUMAN)/AAC
DATE 03-08-2010

EX-109

Approved <div style="font-size: 2em; font-weight: bold;">8</div>	Special Agent in Charge	Do not write in spaces below	
Copies made: 9 - Bureau (105-82024)-(RM) 1 - OSI, MacDill AFB, Fla. (RM) 1 - G-2, Ft. McPherson, Ga. (RM) 1 - ONI, Charleston, S.C. (RM) 3 - Tampa (97-2)		97-3244-230	REG-19 EX-109
		16 DEC 14 1960	

97-4455-7

Copy to: CIA/State/RAB
ONI/OSI/G2
by routing slip for info.
Date: 12/15/60 by: EKH:ada

~~CONFIDENTIAL~~
NATIONAL SECURITY

JAN 3 1961

TP 97-2

ADMINISTRATIVE:

This report is classified ~~confidential~~ inasmuch as it contains information from TP T-2 and TP T-4 which might reasonably result in identification of informants of continuing value and impair the future effectiveness thereof.

In connection with the list of names attributed to [redacted] which was a part of the enclosure with referenced Bureau airtel, many of the names thereon are known members of the Patriotic Movement of Tampa for Aid of Cuban Farmers, which is the subject of a separate investigation (Bu-file 97-4219). Therefore the pertinent information concerning those individuals is not set out in instant report, but will be included in the next report on the PMT.

b7D

INFORMANTS

IDENTITY

LOCATION OF ORIGINAL INFORMATION

TP T-1 is [redacted]
[redacted]

97-2-40

TP T-2 is PSI [redacted]

This report, pages 2,3, 4,6,12,14

b1

TP T-3 is [redacted]
[redacted] Tampa, Florida

97-2-52

b6
b7C
b2
b7D

TP T-4 is PSI [redacted]

97-2-59

TP T-5 is [redacted]

97-2-15, 105-82-50

TP T-6 is [redacted]

105-82-41, 43
97-2-61, p. 27

TP T-7 is [redacted]
[redacted] Fla.

105-105-1

TP T-8 is [redacted]
[redacted]

97-2-48

Careful consideration has been given to the sources concealed herein, and T symbols were used only in those instances where identity must be concealed.

~~CONFIDENTIAL~~

UNITED STATES DEPARTMENT OF JUSTICE
FEDERAL BUREAU OF INVESTIGATION

Copy to: 1 - OSI, MacDill AFB, Fla. (RM) 1 - ONI, Charleston, S. C. (RM)
1 - G-2, Ft. McPherson, Ga. (RM) 1 - INS, Miami, Fla. (RM)

Report of: SA [REDACTED]
Date: December 10, 1960

Office: TAMPA

b6
b7c

Field Office File #: 97-2

Bureau File #: 105-82024

Title: JULY 26TH MOVEMENT,
TAMPA, FLORIDA

DECLASSIFICATION AUTHORITY DERIVED FROM:
FBI AUTOMATIC DECLASSIFICATION GUIDE
DATE 02-23-2010

Character: REGISTRATION ACT - CUBA
INTERNAL SECURITY - CUBA

Synopsis: Persons named by TP T-1 11/7/60 as officers of July 26th Movement in Tampa are identified by Tampa source as officers of a different pro-CASTRO organization known as the Patriotic Movement of Tampa for Aid of Cuban Farmers, except RAUL VILLAMIA who was correctly identified with subject organization. Complete list of officers as of 3/11/60 set out. VICTORIANO MANTEIGA, editor of Spanish-language newspaper "La Gaceta", publicly announced resignation as President of organization in May 1960. Leadership since then exercised by RAUL VILLAMIA as President and CARLOS CARBONELL as Secretary, but they are reported in frequent contact with MANTEIGA and possibly being directed by him. Membership reported at one time around 80 but in spring 1960 totaled 40 and in September 1960 only 6. MARCELINO VILA, former Vice-president, states he resigned in April 1960 when delegate came from Cuba with orders to disband the organization. Informant reported 12/3/60 organization has ceased to exist. Two shipments of old clothes sent to Cuba in May and July 1960. Propaganda allegedly distributed by organization in Tampa described. Announcements on behalf of organization appear in "La Gaceta" over signature of CARLOS CARBONELL, Secretary. On 10/21/60 public rally sponsored by July 26 Movement and other pro-CASTRO groups in Tampa, on which occasion the speaker praised FIDEL CASTRO, Cuba, Russia and China while criticizing U. S. policy toward Cuba. Informant reported 9/12/60 that [REDACTED] stated Cuban Government had requested names of all officers and leaders in order to register them under FARA. List of alleged communists in July 26 Movement of Tampa, as furnished by TP T-1, found to have been prepared from a similar list which originated with

b6
b7c

~~CONFIDENTIAL~~

TP 97-2

TP T-2, but latter did not identify persons thereon as communists or intelligence agents of Cuban Government and states he has no evidence they are so affiliated. Alleged communist affiliations of VICTORIANO MANTEIGA, JUAN PEREZ, and RAMON RODRIGUEZ set out.

- P -

- la -

TP 97-2

DETAILS:

All information in this report attributed to TP T-1 was received on November 7, 1960, and TP T-1 advised he had received the information from [redacted]

b7D

[redacted]

OFFICERS

TP T-1 advised the Club Patriotico 26 de Julio (26th of July Patriotic Club) of Tampa, has as its officers:

*FLA
CUBA*

President	-	FELIPE LIMENEZ
Vice-President	-	MANUEL MIGUEL
Secretary	-	RAUL VILLAMIA
Treasurer	-	GUSTAVO MORAN
Head of Publicity	-	RAMON SANCEZ

TP T-1 stated that in reality, however, the President of this organization is VICTORIANO MANTEIGA, although he appears retired from political activity.

b6
b7C
b7D

TP T-2, a [redacted] advised December 8, 1960, that [redacted]

[redacted] have never been affiliated with the 26th of July Movement, but are in fact known to him [redacted] of a different pro-CASTRO organization known as the Patriotic Movement of Tampa for Aid of Cuban Farmers. A characterization of the latter organization appears in the appendix hereto.

FLA "La Gaceta", a Spanish-language weekly newspaper at Tampa, is edited and published by VICTORIANO MANTEIGA, on March 11, 1960, published the following list of officers of the 26th of July Movement of Tampa: *FLA*

President	-	VICTORIANO MANTEIGA
Vice-President	-	MARCELINO VILA
Secretary General	-	RAUL VILLAMIA
Recording Secretary	-	CARLOS CARBONELL
Propaganda Secretary	-	RAY DELGADO
Secretary of Order and Discipline	-	CRISTO PEREZ
Assistant Recording Secretary	-	HUMBERTO BAEZ
Assistant Secretary of Order and Discipline	-	ALBERTO NUNEZ BORDON

CUBA

TP 97-2

The "Tampa Tribune", a daily newspaper, Tampa, Florida, on May 13, 1960, contained a news story to the effect that VICTORIANO MANTEIGA had resigned as President of the 26th of July organization in Tampa, shortly after he returned from May Day demonstrations in Havana. The story said ill health and the press of business were given as reasons for MANTEIGA's resignation, but it was added that he had stepped down in the wake of reports that United States Immigration and Customs Officials had intensified questioning of persons returning to the United States from Cuba.

TP T-2 stated on December 8, 1960, that since MANTEIGA's resignation, RAUL VILLAMIA has been identified as President, and CARLOS CARBONELL as Secretary of the 26th of July Movement. He added that in recent weeks the name of VILLAMIA has not appeared in connection with publicity for this organization, but only that of CARBONELL, the secretary. TP T-2 also expressed the belief that MANTEIGA continues to be the real leader of the 26th of July Movement, and he stated the reason for this belief is that both VILLAMIA and CARBONELL are seen almost daily visiting MANTEIGA in the offices of "La Gaceta".

TP T-3, who is also a [redacted] Tampa, stated on November 25, 1960, that RAUL VILLAMIA is reported to be the head of the organization now, but that he has observed VILLAMIA visiting the offices of "La Gaceta" almost every day, and he believes his activities are directed by VICTORIANO MANTEIGA.

b7D

MEMBERSHIP

TP T-3 on November 25, 1960, stated he has not been [redacted]

[redacted] TP T-3 stated the 26th of July Movement is not very active and appears to have few members at the present time.

TP T-4, who is in contact with many of the [redacted] [redacted] advised December 1, 1960, that early in 1960 he was told the captioned organization had a membership of around eighty members. He said a short time later he learned the membership only numbered about forty people.

TP 97-2

In September when the organization summoned its members to a joint meeting with the Patriotic Movement of Tampa, only five or six showed up, and the remaining names were summarily stricken from the membership rolls. He said, to the best of his knowledge, there are still only five or six members, possibly even fewer at this time, and the organization has ceased to hold meetings or to have any activity. He said the only members at this time whom he knows by name are RAUL VILLAMIA and CARLOS CARBONELL. On December 3, 1960, he said CARBONELL had stated the Movement has ceased to exist.

~~TAMPA, FLA~~
MARCELINO VILA, owner of La Crema Bakery, 1702 East
[redacted] advised December 8, 1960, [redacted]

[redacted] He said the organization had eighty members at one time, but in the latter part of April, 1960, an official delegate from the July 26th Movement of Cuba, came to Tampa with orders to dissolve the Club. He said at that time all the officers were relieved of their posts [redacted]

b6
b7C

[redacted] He said he is aware that an office is still maintained in the name of the July 26th Movement, and that notices appear in "La Gaceta" from time to time under that name, but he cannot explain this. He said it is his impression that only a committee continues to function at this time.

TP T-2 advised December 8, 1960, concerning the delegate from Cuba in April, 1960, and identified this man as JINES JORRIN CASTROMAN. However TP T-2 said the purpose of this delegate's visit was to unify the pro-CASTRO groups in Tampa, FL. This source expressed the belief that the 26th of July Movement, although it gives the appearance of little activity and few members, actually has many members who never go near the club headquarters because their leaders want them to do their propaganda work under cover. TP T-2 said he has no proof of this, but has reached this conclusion because he knows some of the members who were formerly active in the organization, continue to make propaganda in favor of FIDEL CASTRO, although no longer maintaining any visible contact with the organization leaders.

[redacted]
[redacted] where the headquarters of the 26th of July Movement are located, stated December 8, 1960, that the rent for the headquarters is paid through December 15, 1960, and is payable each month in advance. He said there are very few people who go to the head-

b6
b7C

TP 97-2

quarters at the present time, but that he observed a group meeting there on the night of December 6, 1960, which group numbered some six persons. He said the only ones he knows by name are RAUL VILLAMIA and CARLOS CARBONELL.

ACTIVITIES

CUBA
TP T-1 advised the present work of Tampa's 26th of July Movement Club is the same as in all the other clubs in different American cities. The objective is the distribution of Communist propaganda in this country, and the infiltration of Cuban G-2 that can spy on military installations, etc. The distribution of Cuban Communist propaganda in the Club in Tampa is received directly from the Cuban Consulate in Tampa. *FLA* The Consul, Mr. ALBERTO SACASAS, distributes the propaganda and also pays the members of the G-2 in the locality. Mr. MAXIMILIANO PEREZ, the Vice-Consul, is also a member of the D.I.E.R. and acts as a checking agent on the other G-2 personnel found in Tampa. *OR CLERK* *FLA* *CUBA*

The D.I.E.R. is the Department of Intelligence of the Revolutionary Army.

G-2 is the term used to describe the Intelligence Section of the Cuban Army.

FLA *CUBA*
TP T-4 advised August 13, 1960, [redacted] in Tampa is [redacted] (not ALBERTO) and TP T-4 said he knew for a certainty that all propaganda material furnished by the Cuban Government to the Consulate up to that time, was in the Spanish language, principally the pamphlets titled "Obra Revolucionaria" and "Boletin Cultural". He stated he understood the Cuban Government intended to publish in the near future some propaganda pamphlets concerning the INRA (Agrarian Reform). He said the propaganda received by the Consulate is placed in the anteroom of the Consulate, where it can be readily picked up by any visitor who is interested. He stated the Consul has never made any other efforts to distribute this material.

On December 3, 1960, TP T-4 stated the Consulate has not received any propaganda from Cuba for more than two months.

b6
b7C
b7D

TP 97-2

The same source advised August 13, 1960, and December 1, 1960, he is not aware of the identity of any Cuban intelligence agents in Tampa and his information is to the effect no such agents are paid by the Cuban Consul or known to him. He further stated December 1, 1960, that

[redacted] or that he knows the identity of Cuban intelligence agents in Tampa.

TP T-2 on November 23, 1960, stated he has no information that members of the 26th of July Movement are affiliated with any intelligence organization of the Cuban Government.

b6
b7C

On June 17, 1960, "La Gaceta" published a notice that the 26th of July Movement of Tampa continues to collect clothes and money for the victims of the Chilean earthquake. TP T-4 stated on December 1, 1960, the 26th of July Movement had made two shipments of old clothing to Cuba. One was on May 27, 1960, and consisted of forty-three boxes, the other was on July 8, 1960, and consisted of eighteen boxes. Both shipments were on the MV Privateer, and were directed to the Bienestar Social (Social Welfare), Havana. The shipper of record was CARLOS CARBONELL, Secretary of the 26th of July Movement. TP T-4 said he

On June 10, 1960, [redacted]

[redacted] turned over to SA [redacted] a 29-page pamphlet entitled "The Revolution Has Not Betrayed Cuba" by Dr. OSVALDO DORTICOS TORRADO, President of Cuba, this being a letter directed by President DORTICOS to the students of Chile. The pamphlet contained both Spanish and English language texts of the letter. It was printed by the Ministry of Foreign Relations of Cuba, April 16, 1960. Dr. GONZALEZ stated it was distributed in Tampa by the 26th of July group.

b6
b7C

On July 20, 1960, TP T-5, who is acquainted with many people in the Cuban community in Tampa, made available a pamphlet captioned "ADOLF EICHMANN and the Murderers Among Us". This pamphlet does not show where it was printed but states it was published by the 26th of July Movement in the United States. TP T-5 said he did not know the source of the pamphlet, but that some have been circulated in Tampa presumably by the 26th of July Movement of Tampa.

TP 97-2

The "Tampa Times", a daily newspaper at Tampa, Florida, on August 23, 1960, reported that vandals had the previous night tossed red paint on the windows of the 26th of July Movement, as well as on the door and window of the newspaper "La Gaceta".

On September 23, 1960, "La Gaceta" carried an item captioned "Note from the 26th of July Movement of Tampa", which was over the signature of CARLOS CARBONELL, Secretary. This note criticized an organization of Cubans, which formerly supported CASTRO, but now oppose him and implies they were the persons responsible for two attacks on the headquarters of the 26th of July Movement when windows were broken and other damage done. The note states the 26th of July members have never wanted to indulge in violence, but that they know how to defend themselves when attacked. It calls upon Cubans and Tampanans to support the Cuban Revolution, which it says is not Communist, but humane and Cuban. It states the 26th of July Movement supports the Revolution because it is giving the people of Cuba an honorable government, is concerning itself with the country people who have always been exploited, and is accomplishing many good works for the benefit of the majority of the Cuban people.

TP T-4 advised August 13, 1960, that as far as he could observe, the 26th of July Movement was not active and had barely been collecting enough money to pay the rent for its headquarters. He said no funds had been sent to Cuba in recent months, but that plans were under way for it to get together with other pro-CASTRO groups in Tampa to bring in some out-of-town speakers for a public rally in the near future.

On August 25, 1960, TP T-4 stated the public rally to whip up support for the present government of Cuba was being planned for September 30, 1960. He said that although the 26th of July Movement was active with other pro-CASTRO groups in planning this rally, it was to be advertised as sponsored by the Fair Play for Cuba Committee (FPCC), because it was felt this would have more appeal for the American public generally than the other groups made up primarily of Cubans or Cuban-Americans. A characterization of the Fair Play for Cuba Committee appears in the appendix hereto.

It was subsequently announced, the rally would be

postponed from September 30 to October 21, 1960, and would be held in the Municipal Auditorium.

On October 18, 1960, Deputy United States Marshal [redacted] turned over to the FBI a letter he received that date. The letter was not signed but it referred to the rally to be held October 21st in the Municipal Auditorium by friends of the Cuban Government, and it stated "an anti-Communist group" was planning to go to the rally and attack the pro-CASTRO men. It was stated the 26th of July Movement had given guns to three of their men to defend against such attack, and that the Patriotic Movement of Tampa had also armed some of its men for the same purpose.

b6
b7C

The information in the above letter was furnished the Tampa Police Department October 18, 1960.

The "Tampa Times" on October 17, 1960, reported the city had cancelled the use of the Auditorium for the rally to avoid any possible trouble on city-owned property, in view of the strained Cuban-American relations.

TP T-4 advised October 22, 1960, that the rally, which had been scheduled for October 21st, was held at the headquarters of the 26th of July Movement of Tampa. He said he had understood it was cancelled until about 4:00 PM that date [redacted]

b7D

[redacted] He said approximately eighty people were present, and the press had reported faithfully the speeches that were made.

FZA
The "Tampa Tribune" on October 22, 1960, published an account of the rally. It identified the principal speaker as MERLE E. BYERS, of Mokena, Illinois, a spokesman for the U. S. Farm Association of Iowa, which organization BYERS described as an outgrowth of the Iowa Farmers Union with headquarters in Des Moines. It was reported BYERS claimed to be a "small businessman who is getting put through the wringer, one of the forgotten people, the unsubsidized, who are victims of our moronic national administration." BYERS was quoted as saying "The United States is a fortress of Fascism and the enemy of intellectualism;" also that Cubans are full of purpose as are millions of Chinese and Russians, but ours is a sick society with no meaning or purpose. He was further quoted as saying: "The people will lose no matter which candidate wins (in the 1960 Presidential elections) because they were not chosen by the

people but by a selected few representing the interests of the ruling economic oligarchy."

The "Tampa Tribune" report went on to say that BYERS indirectly praised Soviet Premier KRUSHCHEV, using an ironic tone in quoting a Chicago "Sun-Times" editorial accusing the Communist boss of being "a troublemaker who wants us to end the arms race." BYERS declared:

"We don't want to end the arms race because of the jobs and profits from the valuable munitions contracts which support our economic system. The pattern of the cold war has been set as has our attitude toward Cuba."

The last statement, noted the "Tribune", drew an outburst of rhythmic applause, as did BYERS' statement the U. S. sugar-land barons had grown fat on the bodies of the children of Cuba's slave workers. It was said BYERS had high praise for FIDEL CASTRO and that he said:

"The United States doesn't like to help under-developed nations like Cuba because this helps to build socialism which is wrong except where it benefits the oligarchy. That's why we are so hostile to CASTRO, because our heartstrings, I mean, our pursestrings have been hurt."

"La Gaceta" on October 21, 1960, published an item captioned "Note from the 26th of July Movement", which was over the signature of CARLOS CARBONELL, Secretary, a translation of which follows:

"We advise the people of Tampa that unscrupulous people have been threatening to get worthy Cuban fired from their jobs by denouncing them as Communists.

"Those people believe they are the law, in spite of their antecedents, and we advise them that they will be brought into court if they try to prejudice American citizens who sympathize with the Government of Cuba because it is honorable and seeks the well being of

the Cuban people.

"No member of this club is Communist and his civil rights cannot be trampled upon.

"We know of two cases, one a youth who works on Seventh Avenue, and the other a worker in an industry on 22nd Street."

On November 4, 1960, "La Gaceta" carried a notice addressed to the people of Tampa and stating that again vandals had broken the windows of the 26th of July Movement Headquarters and damaged the American flag inside the club. The notice concluded with the following statement:

"And if they really want to fight FIDEL CASTRO, remember that in Miami and Guatemala expeditions are being prepared against the Cuban Government in spite of the Organization of American States and the United Nations.

"By agreement of the 26th of July Club,
CARLOS CARBONELL; Secretary."

On November 18, 1960, "La Gaceta" carried an item captioned "Note from the 26th of July Movement" over the signature of CARLOS CARBONELL, Secretary, which warned that a man had announced in a local paper he would give Cuban money for American money on a basis of three for one. The note warned that people should not agree to such an exchange because it is not intelligent to go to visit a country, and fall into something which is unworthy, and for the further reason that they would be running a risk of being jailed.

On December 2, 1960, "La Gaceta" reported that the 26th of July Movement of Tampa had on the preceding Sunday placed a crown of flowers in the Jose Marti Park of Tampa. It was stated that although a daily newspaper had reported only two persons placed the flowers in the park, there actually had been more than twenty people present for the ceremony.

CONNECTIONS WITH CUBAN GOVERNMENT

TP T-4 reported September 12, 1960, that [redacted] whom he identified as a representative of the 26th of July Movement in Tampa, had that day been heard to state the Cuban State Department had directed a cable to an unnamed person in Tampa to obtain the names of the officers and leaders of both the 26th of July Movement and the Patriotic Movement of Tampa for Aid of Cuban Farmers, and forward same to Cuba so that they could be registered with the United States State Department as Cuban agents.

b6
b7C
b7D

✓ TP T-4 reported November 14, 1960, that [redacted] also known as [redacted] whom he described as an [redacted]

CUBA
NY
FLA

[redacted] was reported to have said he wanted to find out why the 26th of July Movement in Tampa is dead.

TP T-4 reported later the same week that [redacted] did not come to Tampa because he and the Consul General in Miami had received orders from the Cuban Government to stay in Miami in view of increased tensions due to the sending of American naval vessels to patrol the Caribbean.

ALLEGED COMMUNIST INFILTRATION OF
JULY 26 MOVEMENT OF TAMPA

It has been previously reported that TP T-1 made the statement that all the officers and members of the July 26 Movement are active Communist Party (CP) members or agents of CASTRO's G-2, and he furnished a list of individuals which he described as "List of Members of the Communist Cell Inside 'The 26th of July Movement Club' of Tampa, Florida."

This list is almost identical to a list of names furnished October 13, 1960, by TP T-2 except that TP T-2's list does not allege all the persons thereon to be affiliated with the CP or with Cuban intelligence organizations.

The Communist Party, U.S.A., has been designated by the Attorney General of the United States pursuant to Executive Order 10450.

On November 23, 1960, TP T-2 advised he personally prepared the list of names which he had earlier furnished the FBI, doing so from his own knowledge of the individuals or from information he has received concerning them from his associates in Tampa. He stated he knows a copy of his list subsequently reached the possession of [redacted]

b6
b7C
b7D

On December 5, 1960, [redacted] attorney, Tampa, Fla., advised that [redacted] is his client and that he knows [redacted]

TP T-2 also stated November 23, 1960, he cannot identify any of the persons on the list he furnished as connected with the D.I.E.R. or G-2 for the reason he is not in a position to know who might or might not be so connected.

TP T-8, [redacted] on October 22, 1960, advised that in view of the turn of events in the Cuban Government it is his belief that all members of the July 26 Movement are necessarily communists. He furnished a list of persons in various cities of the United States said to be members of this organization, adding that he had compiled the list from information appearing in the newspaper "Revolucion", which is published daily in Havana as the official organ of the July 26 Movement.

TP 97-2

The list furnished by TP T-8 contained the following names for Tampa, Florida:

CUBA

CARMEN LOPEZ
TERESA DELGADO
VIDAL FIALLO

*Believed To be
C.P. members*

Concerning VICTORIANO MANTEIGA, the former President and alleged to be possibly still the leader of subject organization, TP T-6, who has knowledge of some CP activities and personalities at Tampa, reported in December 1942 and on March 12, 1943, that MANTEIGA had at one time been a member of the CP and active in various front organization but that he had had some disagreement with the CP four or five years before that and had not been active since then. He further stated March 12, 1943, that during the preceding year or two MANTEIGA's writings in "La Gaceta" had been critical of the CP.

TP T-6 advised in February 1944 that MANTEIGA was not then active in the CP or any of its front organizations.

TP T-5 on September 3, 1953, reported that during the preceding week a newspaper editor named [redacted] in Havana stated in the presence of about ten persons that VICTORIANO MANTEIGA, of Tampa, Florida, is a member of the CP in Cuba. He allegedly stated he was going to write some articles about it and then turn over to the FBI his evidence.

b6
b7C

On July 12, 1960, [redacted]

CUBA

[redacted] stated he considered MANTEIGA dangerous to this country because of influence ^{b6} has on the Spanish-speaking community through "La Gaceta", ^{b7C} he added a check into MANTEIGA's past would show he has had ^{b7D} communist sympathies since the 1920s or 1930s. On December 1, 1960, [redacted] stated he has no first-hand knowledge or evidence that MANTEIGA is or ever has been a communist, but his opinion is based upon MANTEIGA's writings in "La Gaceta" and his knowledge that the United States Government was investigating MANTEIGA in connection with communist activities at Tampa as far back as the 1930s.

b6
b7C

Concerning [redacted]

TP T-6 reported in March 1942 this individual had been an active member of Unit #1 of District 25 of the CP, Tampa, and served as a Party "mailman" for about six months in 1939 but was no longer active in that respect. The same source in December 1943 stated [redacted] did not attend CP meetings and was not then known as a CP member.

TP 97-2

In July 1942 [redacted] Tampa, stated [redacted] had been a CP member for many years and in a recent conversation stated that things were really going well for the Party and that people were going to be surprised at the rise of the CP.

On August 2, 1950, [redacted] Florida, reported that he was in [redacted] July 31, 1950, at which time [redacted] expressed his views in favor of communism.

[redacted] was interviewed by Special Agents of the FBI February 28, 1957, at which time he denied membership in the CP although admitting he had been outspoken in his "liberal" ideas and he knew some acquaintances considered him a communist. At the same time he said he had read the "Daily Worker" and other communist literature in the past.

B. APPROX. 1937

Concerning [redacted] TP T-7 reported July 5, 1960, this person is a leader in the July 26 Movement, and he described him as anti-American and communist. Questioned concerning the allegation of communism on December 8, 1960, TP T-7 said he has no evidence of RODRIGUEZ' affiliation with the CP but based his allegation upon the man's fanatical support of the present Government of Cuba which TP T-7 considers to be communist.

b6
b7c

In connection with the possibility this [redacted] might be identical with an individual of the same name who was reported by TP T-6 in early 1945 as a member of the Tampa section of the National Council of American-Soviet Friendship, TP T-2 advised that the [redacted] of the July 26 Movement is now [redacted]

The National Council of American-Soviet Friendship has been designated by the Attorney General of the United States pursuant to Executive Order 10450.

[redacted] advised December 8, 1960, he never heard communism or Russia talked of in meetings of the organization and was never aware of any communist influence in the July 26 Movement.

APPENDIX
THE PATRIOTIC MOVEMENT OF TAMPA
FOR AID OF THE CUBAN FARMERS

The Patriotic Movement of Tampa for Aid of the Cuban Farmers (Movimiento Patriotico de Tampa de Ayuda al Campesino Cubano) (PMT) was formed in Tampa, Florida in August, 1959 by ROBERTO DE LOS RIOS, FELIPE JIMENEZ and ENRIQUE MENDOZA, Cuban nationals, for the ostensible purpose of aiding the Cubans peasants in the agrarian reform by the collection of money and goods. The bylaws state the purpose of the organization is to give moral and material aid to the Cuban farmers at the same time promoting a better understanding between the peoples of the U.S. and Cuba.

Although this was its ostensible purpose, sources, who are considered reliable and who were in a position to have this information, advised that it was common knowledge known to all members that the actual original purpose of the organization was to buy airplanes for Cuba for defense.

Investigation indicates that the PMT has had little success in its collections; however DE LOS RIOS, who has returned to Cuba, and his successor JIMENEZ, who distributes the Cuban newspaper "REVOLUCION" in Tampa, and other officers of the PMT have issued considerable propaganda in the form of speeches, press releases and pamphlets universally lauding FIDEL CASTRO and his policies and criticizing U.S. "Imperialism" and policies.

The PMT maintains its headquarters in an office rented at 2006 14th Street, Tampa, Florida, in the same building wherein the Tampa 26th of July Movement has its headquarters.

~~CONFIDENTIAL~~

TP 97-2

APPENDIX

FAIR PLAY FOR CUBA COMMITTEE

The April 6, 1960, edition of the "New York Times", a daily New York City newspaper, carried a full page advertisement captioned "What is Really Happening in Cuba?" The article maintained that the United States press has made certain charges against Cuba which are not true and the Fair Play for Cuba Committee was organized to tell the truth about Cuba in the interest of fair play. The advertisement closes with a note which states "This public appeal for Fair Play for Cuba has the support of a group of thinking individuals holding a variety of political persuasions, representing no one but themselves, linked here by a single common concern for the overriding principle of justice which is always at issue, whenever partisan interests clash with simple truth."

- 16* -

~~CONFIDENTIAL~~



UNITED STATES DEPARTMENT OF JUSTICE

FEDERAL BUREAU OF INVESTIGATION

In Reply, Please Refer to
File No.

Tampa, Florida
December 12, 1960

Title July 26th Movement,
Tampa, Florida

Character Registration Act - Cuba
Internal Security - Cuba

b6
b7c

Reference is made to the report of Special
Agent [redacted] dated and captioned above,
at Tampa, Florida.

All sources used in referenced communication
have furnished reliable information in the past, with
the exception of TP T-2, T-3, T-7 and T-8, with whom
contact has been insufficient to establish their relia-
bility.

This document contains neither recommendations
nor conclusions of the FBI. It is the property of the
FBI and is loaned to your agency; it and its contents are
not to be distributed outside your agency.

F B I

Date: 12/12/60

Transmit the following in _____
(Type in plain text or code)

Via AIRTEL AIRMAIL
(Priority or Method of Mailing)

TO: DIRECTOR, FBI (105-82024)

No deletion per OGA letter dated 3/1/2010

FROM: SAC, TAMPA (97-2)

JULY 26 MOVEMENT, TAMPA, FLORIDA
REGISTRATION ACT - CUBA
INTERNAL SECURITY - CUBA

ALL INFORMATION CONTAINED
HEREIN IS UNCLASSIFIED
DATE 03-08-2010 BY UC 60322 LP/STP/SZ

ReBuairtel to Tampa 11/10/60

Enclosed to Bureau are nine copies of report of
SA [redacted] dated 12/10/60 at Tampa.

The [redacted] report, which was enclosed with reBuairtel, shows a general knowledge of the Cuban community of Tampa and the history of the July 26th Movement there, but it contains some inaccuracies, as shown in enclosed report, and is replete with allegations of affiliation with Cuban intelligence organizations and "International Communism" for which no factual basis is given.

b6
b7C
b7D

Reference is also made to my airtel 11/30/60. As pointed out therein and in enclosed report, it appears reasonably well established that the/so-called [redacted] report" was actually prepared by [redacted] of Tampa, who has been identified as the [redacted]. It also appears the "List of Members of the Communist Cell Inside the July 26 Movement Club of Tampa, Fla." was prepared by [redacted] from a list of names originally compiled by [redacted]

[redacted] although [redacted] identified his list as members of the two pro-CASTRO organizations in Tampa and he has acknowledged he has no information linking the persons thereon with Cuban intelligence organizations.

3 - Bureau (Encls 9) (RM)
2 - Tampa
HKR:cwp
(5) ENCLOSURE

EX 109

REC-7 97-4455-8

~~97-3247-331~~

Copy to: CIA/State/RAB
ONI/OSI/G2/~~DOC~~ 16 DEC 14 1960
by routing slip for info. ~~ICC Customs~~
Date 12-15-60 by ERH: [redacted]

CC - WICK

Approved: [redacted] Special Agent in Charge

Sent _____ M Per _____

7 DEC 21 1960

Comments re the reliability of [redacted] are contained in my airtel of 11/30/60.

Information in Tampa files does not substantiate the allegations of CP membership or sympathy in most of the cases, although some substantiation is found in the following instances:

[redacted] is identical with [redacted] previously identified as a member of the CP at Tampa. He is a member of the Patriotic Movement of Tampa for Aid of Cuban Farmers, rather than the July 26 Movement. E.H. ✓

[redacted] aka [redacted] is identical with the [redacted] mentioned on page 3 of the [redacted] list. He has been identified as a CP member in Tampa in the past. He is reported to [redacted]

[redacted] and [redacted] have all been investigated in the past in connection with alleged communist activities, and a synopsis of the information concerning [redacted] and [redacted] is contained in enclosed report. [redacted] and [redacted] have not been connected with the July 26 Movement. [redacted] is reported to have [redacted]

b6
b7C
b7D

FLA

Following are the individuals listed in the [redacted] report on whom investigations were already pending prior to receipt of that report:

	<u>Tampa file</u>	<u>Bureau file</u>
[redacted]	100-27	100-157394
	100-95	100-327943
	105-86	
	105-89	
	105-221	105-93078
	105-187	

TP 97-2

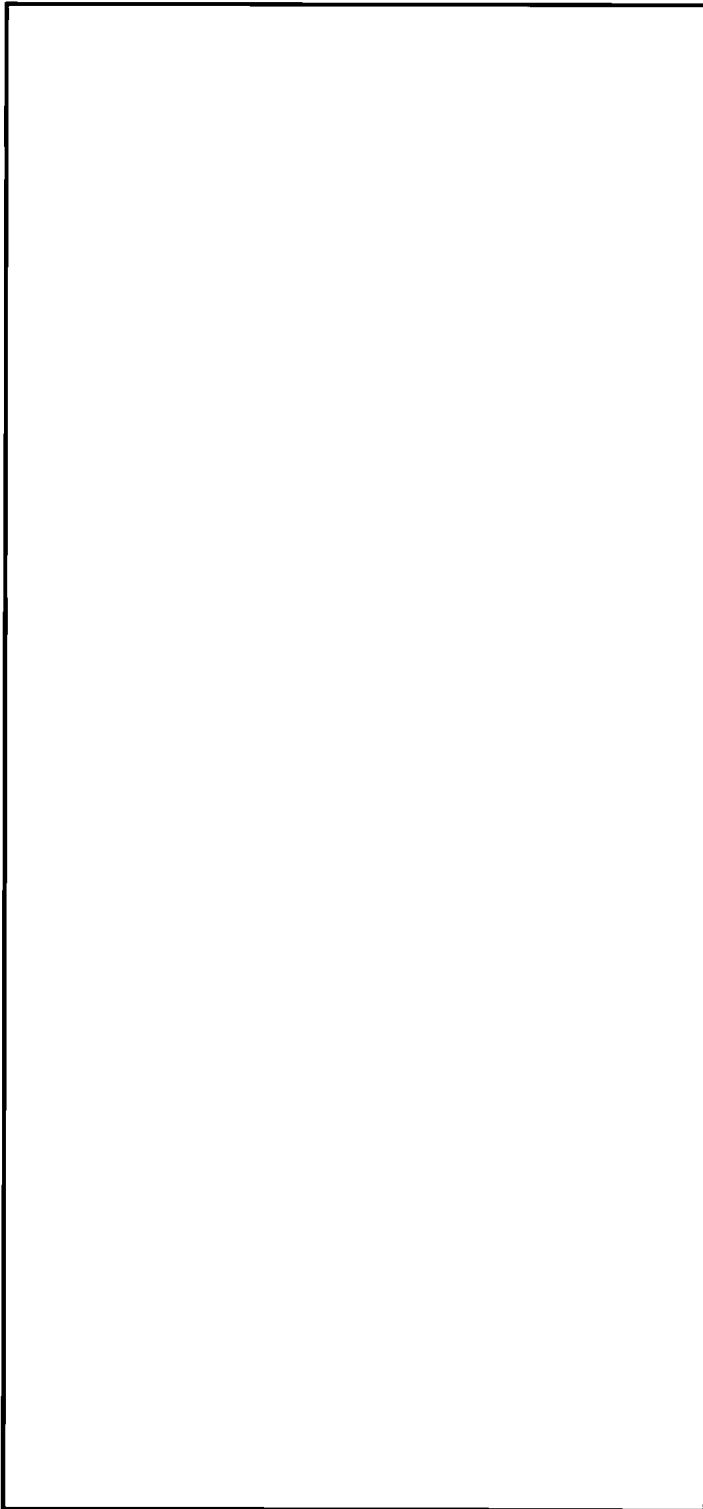

105-184	105-93648
105-183	105-93656
105-51	105-93599
105-93	
105-201	100-194274
105-198	105-93600
105-82	100-21195
105-103	b6
105-95	b7C
105-97	b7D
105-98	105-93406
105-120	105-91218
100-96	100-19014
100-37	
105-84	105-91211
105-196	
105-105	
105-218	
105-180	105-93399
105-141	105-93616
105-181	105-93618
105-99	

TP 97-2



105-96	105-93551
105-101	105-91147

Following are cases under IS-Cuba character wherein investigation has been initiated on the basis of information contained in the  report:

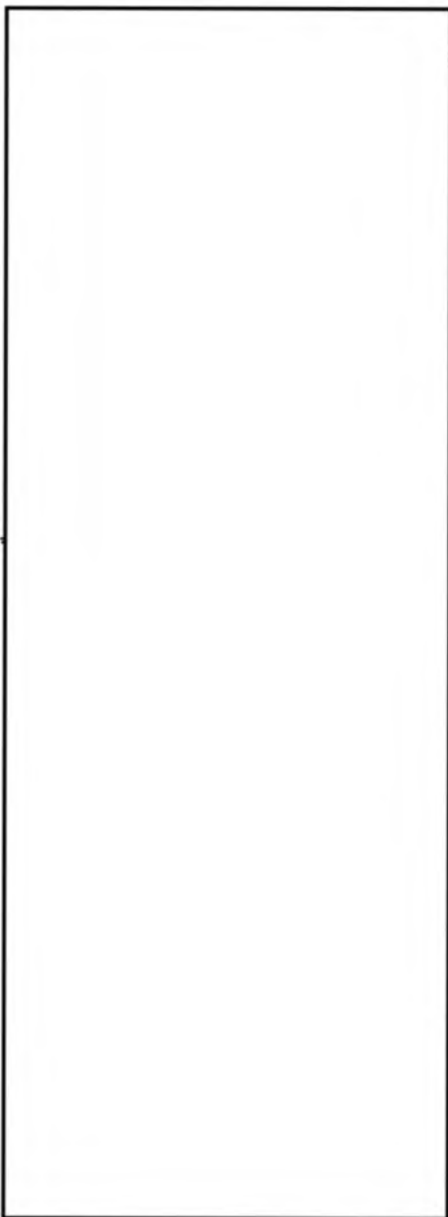

105-257	
105-261	
105-260	105-93557
105-262	105-93535
105-263	105-93536
105-288	
105-264	
105-244	
105-267	105-93590
105-268	105-93580
105-269	105-93577
105-270	105-93572
105-256	105-93555
105-266	105-93591
105-289	105-93598
105-271	105-93549
105-278	105-93595
105-279	105-93594

b6
b7C
b7D

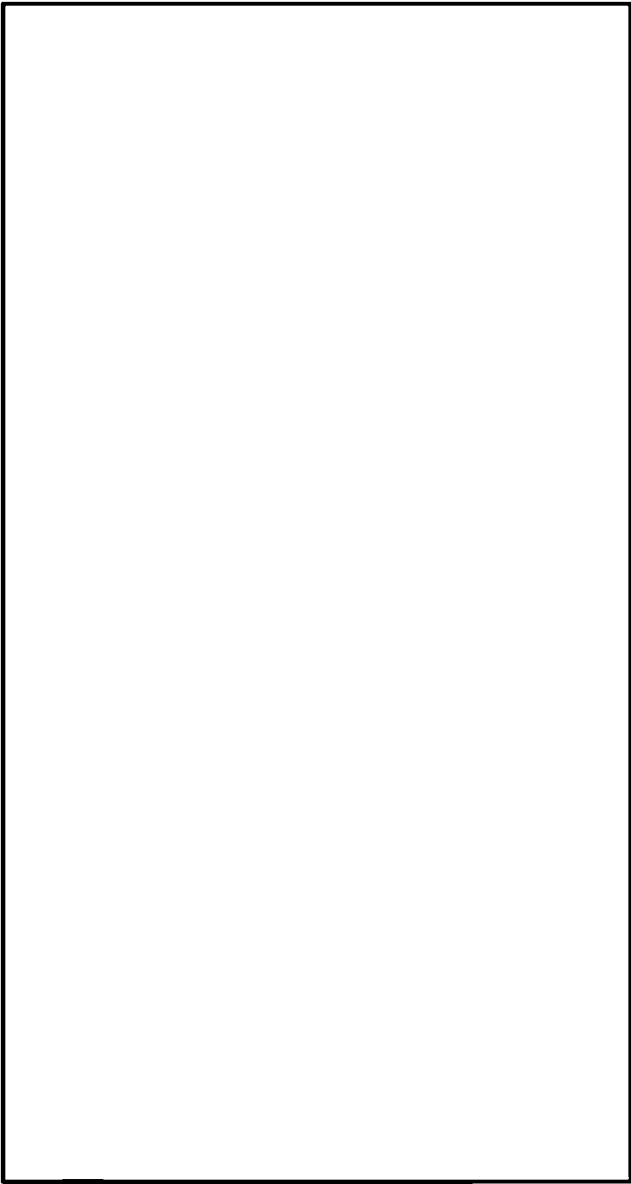

105-280	105-93661
105-281	105-93667
105-282	
105-283	105-93637
105-284	105-93613
105-285	105-93636
105-245	105-93597
105-277	105-93635
105-276	105-93634
105-274	105-93631
105-275	
105-286	
105-258	
105-241	
105-252	105-93552
105-253	105-93570
105-254	105-93553
105-255	

b6
b7C
b7D

Cases are also in the process of being opened on the individuals identified in the [redacted] list only as [redacted]. The Bureau will be advised as these persons are identified sufficiently to enable a search of Bureau and Miami indices.

FEDERAL BUREAU OF INVESTIGATION

Reporting Office TAMPA	Office of Origin TAMPA	Date 2/2/61	Investigative Period 12/12/60-1/20/61
TITLE OF CASE JULY 26TH MOVEMENT TAMPA, FLORIDA		Report made by <div style="border: 1px solid black; width: 150px; height: 15px;"></div>	Typed By: JN
		CHARACTER OF CASE RA - CUBA IS - CUBA	

b6
b7C

~~XXXXX~~
ST
C 17
ADMINISTRATIVE:
REFERENCE: Report of SA Tampa, 12/10/60.

- C -

This report is classified confidential inasmuch as it contains information from TP T-1 which might reasonably result in identification of an informant of continuing value and impair the future effectiveness thereof.

Inasmuch as the July 26th Movement of Tampa has been disbanded and the official headquarters, Club 26 de Julio, located at the corner of 9th Avenue and 14th Street, Tampa, Florida, has been closed and no further investigation is to be conducted in this matter, a closing report is submitted herewith.

Approved 	Special Agent in Charge	Do not write in spaces below	
Copies made: 9 - Bureau (97-4455) (RM) 1 - OSI, MacDill AFB, Fla. (RM) 1 - G-2, Ft. McPherson, Ga. (RM) 1 - ONI, Charleston, S.C. (RM) 1 - Tampa (97-2)		97-4455-91	REC-91
59 FEB 13 1961		FEB 6 1961	

Copy to: CIA/State/RAB
ONI/OSI/G2/FAO

by routing slip for info.

Date 2/10/61 by CRH:sdw

NAT. SECURITY

TP 97-2

INFORMANTS

IDENTITY

LOCATION OF ORIGINAL
INFORMATION

TP T-1 is

[REDACTED]

97-2-72

b6
b7C
b7D

Careful consideration has been given to the sources concealed herein, and T symbols were used only in those cases where identity must be concealed.

~~CONFIDENTIAL~~
 UNITED STATES DEPARTMENT OF JUSTICE
 FEDERAL BUREAU OF INVESTIGATION

DECLASSIFICATION AUTHORITY DERIVED FROM:
 FBI AUTOMATIC DECLASSIFICATION GUIDE
 DATE 02-23-2010

Copy to: 1 - OSI, MacDill AFB, Fla. (RM)
 1 - G-2, Ft. McPherson, Ga. (RM)
 1 - ONI, Charleston, S.C. (RM)
 1 - INS, Miami, Fla. (RM)

Report of: SA [REDACTED]
 Date: 2/2/61

Office: Tampa

Field Office File No.: TP 97-2

Bureau File No.: 97-4455

Title: JULY 26TH MOVEMENT,
 TAMPA, FLORIDA

Character: REGISTRATION ACT - CUBA
 INTERNAL SECURITY - CUBA

Synopsis: On 1/4/61 vandals wrecked the clubrooms of the 26th of July Movement and the Patriotic Movement of Cuba at 14th Street and 9th Avenue. Clubroom windows and furniture were smashed. Red paint was smeared in the 26th of July offices. On 1/9/61 Detective [REDACTED] Tampa Police Department, advised that he has been assigned to investigate Cuban matters in Tampa, particularly acts of vandalism on the Cuban Consulate, 26th of July Club, and Patriotic Movement of Tampa offices. [REDACTED] said that RAUL VILLAMIA, president of the 26th of July Club, was asked to take down some signs displayed at the 26th of July office as they were considered inflammatory and might inspire further vandalism. VILLAMIA advised that the 26th of July was closing its offices and that the lease on their office space would expire 1/15/61. [REDACTED] said that [REDACTED] was writing a letter disbanding the 26th of July organization in Tampa. This letter was published in "La Gaceta" on 1/13/61 and stated that by unanimous agreement the 26th of July Club was being closed because the government of the United States has broken its relations with Cuba.

b6
 b7c

- C -

DETAILS:

Cuba *FLA*
 "La Gaceta", a Spanish language newspaper at Tampa, reported on December 2, 1960, that CARLOS CARBONELL, President of the 26th of July Movement of Tampa, had represented his organization in placing a wreath at the statue of JOSE MARTI in Jose Marti Park, corner of 8th Avenue and 13th Street, Tampa, Florida, on November 27, 1960. This was in honor of the fifth anniversary of the founding of the movement and CARBONELL made a speech in memory of the medical

19
~~CONFIDENTIAL~~

TP 97-2

students who had been shot by the Spanish volunteers. The wreath was removed during the night by unknown persons.

TP T-1 who is a [redacted] Florida, advised December 26, 1960, that [redacted]

[redacted] Source said the individuals who made such reports were members of the July 26 Movement of Tampa and the Patriotic Movement of Tampa for Aid of Cuban Farmers, a characterization of which appears in the appendix hereto. The only individual he could identify by name was VICTORIANO MANTEIGA, editor of "La Gaceta" and former president of 26th of July Movement.

b6
b7C
b7D

On January 4, 1961, the "Tampa Tribune", a daily newspaper, Tampa, Florida, published an article stating that police were hunting vandals who wrecked the clubrooms of the 26th of July Movement and the Patriotic Movement of Tampa on the night of January 3, 1961. It was stated the two clubrooms, located in the same building at the corner of 14th Street and 9th Avenue, had their windows and furniture smashed and that red paint had been smeared in the July 26th offices.

On January 9, 1961, Detective [redacted] Tampa Police Department, advised SA [redacted] that he had been assigned to investigative matters relating to Cuban activities in Tampa, particularly those investigations concerning acts of vandalism perpetrated on the Cuban Consulate in Tampa and the 26th of July and Patriotic Movement of Tampa for Aid to the Cuban Farmers (PMT) as well as to private residences.

b6
b7C

During the course of investigation of vandalism at the 26th of July Club on 9th Avenue, [redacted] contacted PAUL VILLAMIA, a city employee and president of the 26th of July, and requested that he take down some signs displayed at the 26th of July which he considered inflammatory and might inspire further vandalism. These signs called attention to previous vandalism and their perpetrators in insulting terms. VILLAMIA took down the signs. From VILLAMIA and the manager of the building where the club is located, he learned that the 26th of July is closing its offices there. VILLAMIA said their lease was expiring January 15, 1961, and they were not renewing it. The manager said the 26th of July was being asked to move out January 15, 1961. The PMT, which has offices in the same building, but located on 14th Street, closed down the night of the breaking of relations between the United States and Cuba and moved into the 26th of July offices.

Furthermore, [redacted] told [redacted] on January 8, 1961, that [redacted] was writing or publishing a letter disbanding the 26th of July organization in Tampa this week.

b6
b7c

On January 13, 1961, "La Gaceta" published an item captioned "For the People of Tampa -- About the 26th of July Movement", a translation of which follows:

"In a meeting that took place a few days ago, we decided to close the 26th of July Club, not for the depredations of some individuals that call themselves anti-communists in order to carry out criminal acts in Tampa, but because the government of the United States has broken off its relations with Cuba.

"Everyone was in complete accord with this decision to dissolve the Club and pray for better relations between the people and the governments of Cuba and the United States.

"In the 26th of July Club there were no communists but only civic-minded men, enemies of violence and defamation.

"Those who in Tampa and other places, wish to defeat FIDEL CASTRO by throwing stones and paint, destroying furniture and window glass, are fascists or anti-democratic. As far as the case of Consul SACASA goes, he has said that since last October he has been 'turning over the secrets' of the government that paid his salary and to which he had promised his loyalty.

"Any man can stop sympathising with another person, party, or government, but it is 'ugly', nauseating, that he be living off the man, business or government and at the same time, stabbing him in the back.

"With a hope for better relations between Cuba and the United States, we salute all, and especially the tobacco factory workers classified as communist by SACASA and other individuals that have come to this city during the last few months to disturb the tranquil life of Ybor City, West Tampa and of Tampa.

"COMMITTEE OF THE 26TH OF JULY OF TAMPA"



UNITED STATES DEPARTMENT OF JUSTICE
 FEDERAL BUREAU OF INVESTIGATION
 Tampa, Florida
 February 2, 1961

In Reply, Please Refer to
 File No. 97-2

Title JULY 26TH MOVEMENT
 TAMPA, FLORIDA

Character REGISTRATION ACT - CUBA -
 INTERNAL SECURITY - CUBA

Reference Report of SA [REDACTED]
 dated 2/2/61, at Tampa.

b6
 b7C

All sources (except any listed below) used in referenced communication have furnished reliable information in the past.

TP T-1 who is mentioned in this report and with whom there has been insufficient contact to determine his reliability, furnished information but it is noted that he is in a position to provide reliable information.

ALL INFORMATION CONTAINED
 HEREIN IS UNCLASSIFIED
 DATE 02-23-2010 BY UC 60322 LP/STP/SZ



- Tolson _____
- Mohr _____
- Parsons
- Belmont
- Callahan _____
- DeLoach
- Malone _____
- McGuire _____
- Rosen _____
- Tamm _____
- Trotter _____
- W.C. Sullivan _____
- Tele. Room _____
- Ingram _____
- Gandy _____

at bank

Pro-Castro Unit to Disband
 TAMPA, Fla., Jan. 14 (UPI) — The pro-Castro 26th of July Movement here, discouraged by the break in Cuban - United States relations, vandalism and defections, announced yesterday that it would disband.

The Tampa branch, founded personally by Fidel Castro in 1955 when he was in exile, had long been a stronghold of Cuban revolutionary sentiment in this country. At one time its membership was estimated at 20,000.

The 26th of July offices here have been subjected recently to attacks from vandals who smashed furniture, files and windows and smeared the walls with red paint.

Handwritten notes:
 [Illegible scribbles]
 Nathaniel
 [Illegible]

ALL INFORMATION CONTAINED
 HEREIN IS UNCLASSIFIED
 DATE 02-23-2010 BY UC 60322 LP/STP/SZ

Handwritten notes:
 July 26th MOVEMENT,
 TAMPA, FLA.
 IS - CUBA
 RA - CUBA

- The Washington Post and Times Herald _____
- The Washington Daily News _____
- The Evening Star _____
- New York Herald Tribune _____
- New York Journal-American _____
- New York Mirror _____
- New York Daily News _____
- New York Post _____
- The New York Times 3
- The Worker _____
- The New Leader _____
- The Wall Street Journal JAN 15 1961
- Date _____

Vertical stamp:
 RECEIVED
 20 MAR 21 1961

Handwritten: File #5 - EA
 97-4455 - A
 NOT RECORDED
 JAN 24 1961

63 JAN 24 1961

Handwritten: 97-4455 -



S. B. Donahoe

1-5-61

E. R. Farrell

1 - Mr. Donahoe
1 - Mr. Farrell

CUBAN FUNDS
IS - CUBA

In accordance with Foreign Assets Control memo 7-11-60 confirming its request for reports concerning certain pro-Castro individuals and organizations, the following reports were sent to Foreign Assets Control, Treasury Department, on the dates indicated:

<u>DATE</u>	<u>PAGES</u>	<u>DATE</u>	<u>OFFICE OF ORIGIN</u>
	3	12-20-60	Tampa
	4	12-20-60	Los Angeles
	2	12-21-60	Tampa
July 26th Movement of New York 355		12-21-60	New York
	1	12-14-60	Miami
	2	12-15-60	Tampa
July 26th Movement of Tampa, Florida	Report dated 12-12-60	12-15-60	Tampa
	4	12-29-60	Philadelphia
	3	12-30-60	WFO

b6
b7c

ORIGINAL COPY FILED IN 62-105411-

Treasury has indicated it is considering freezing the assets of Cuban agents in the United States.

97-4455-
NOT RECORDED
184 JAN 10 1961

ACTION:

For record purposes.

- 1 - 105-91151
- 1 - 105-23687
- 1 - 105-93616
- 1 - 97-3243 (July 26 Movement - NY)
- 1 - 105-93301

- 1 - 105-91211
- ① - 97-4455 (July 26th Movement - Tampa)
- 1 - 105-89776
- 1 - 105-92534

62 JAN 22 1961

744

UNITED STATES GOVERNMENT
MEMORANDUM

Copy to: CIA/State/RAB
ONI/OSI/G2 / JAC
by routing slip for info.
Date 3-10-61 by ECH/peo

TO: DIRECTOR, FBI (97-4455) DATE: MAR 1 1961
FROM: SAC, TAMPA (97-2)
SUBJECT: JULY 26TH MOVEMENT, Tampa, Florida
IS-CUBA; RA-CUBA

EX 10961

REC 74 encl

REFERENCES:

- Report of SA [redacted] 12/10/60, at Tampa
- Report of SA [redacted] 12/5/60, at Miami
- Miami airtel to Bureau, 12/5/60.
- Tampa letter to Bureau, 11/29/60 -
- Tampa airtels to Bureau 12/1/60 and 11/30/60
- Bureau airtel to Tampa and Miami, 11/10/60.

Enclosed herewith are nine copies of a letterhead memorandum relating to an interview with [redacted]

- 2 - Bureau (Encl. 9) **EXCLOSURE**
- 1 - Miami (105-2374) (Info) (Encl. 1)

- 74 - Tampa
 - cc - 97-16
- | | | | | |
|---------|---------|---------|---------|------------|
| 105-101 | 105-241 | 105-267 | 105-285 | |
| 100-27 | 105-103 | 105-244 | 105-268 | 105-286 |
| 100-37 | 105-105 | 105-245 | 105-269 | 105-288 |
| 100-95 | 105-107 | 105-252 | 105-270 | 105-289 |
| 100-96 | 105-120 | 105-253 | 105-271 | 105-310 |
| 105-51 | 105-141 | 105-254 | 105-274 | 105-311 |
| 105-82 | 105-180 | 105-255 | 105-275 | 105-312 |
| 105-84 | 105-181 | 105-256 | 105-276 | 105-314 |
| 105-86 | 105-183 | 105-257 | 105-277 | [redacted] |
| 105-89 | 105-184 | 105-258 | 105-278 | |
| 105-93 | 105-187 | 105-260 | 105-279 | 2-97-2 |
| 105-95 | 105-196 | 105-261 | 105-280 | |
| 105-96 | 105-198 | 105-262 | 105-281 | |
| 105-97 | 105-201 | 105-263 | 105-282 | |
| 105-98 | 105-218 | 105-264 | 105-283 | |
| 105-99 | 105-221 | 105-266 | 105-284 | |

REC-85

97-4455-10

EX-112

CLASSIFIED

RSC: ih
(77)

57 MAR 27 1961

Let to Tampa 27 1961
3-7-61 6 H...
17

NAT. SEC.

197-4541
REPRO COPY AND COPY OF ENCL. ENCL. 2

This information is a follow-up of information recorded in reference communications and others treating with the information furnished by [redacted]

As noted in referenced communications the [redacted] information consists of a history of the 26th of July Movement in Tampa, considered relatively accurate, plus a list of names of persons in Tampa termed Communists or agents of the Cuban D. I. E. R. This list of names is almost identical to a similar list furnished this office by PSI [redacted] except that [redacted] furnished the list as being the identities of pro-CASTRO individuals in Tampa [redacted]

[redacted] stated he made up this list from his own knowledge and furnished a copy to [redacted]

The "report" produced by [redacted] referred to herein, was examined by SA [redacted] and determined to be an identical Spanish language version of the report furnished by the [redacted]

b6
b7C
b7D

[redacted] and therefore was not reproduced herein.

[redacted] during the course of this interview, stated she made up this list from information [redacted]

[redacted] and from her own knowledge. She stated that she furnished a copy of this list to [redacted]

She stated that both she and [redacted]

It is noted that [redacted] furnished his list to this office on the early afternoon of October 13, 1960. According to information from Miami the raid on the Cuban Consulate there, which [redacted]

b6
b7C
b7D

[redacted]
[redacted]
occurred about noon on October 13, 1960. [redacted]

[redacted]

Furthermore, Miami has advised that a supposed list of persons obtained in the raid on the Consulate in Miami has been circulated about and is considered to have no value. Also, no information is available that the D. I. E. R. has ever operated agents outside of Cuba, and in the summer of 1960, was reported in the process of dissolution (see report of SA [redacted] 8/19/60, at Miami, captioned Cuban Intelligence Activities in the U. S., Bufile 105-80787).

The above tends to substantiate information previously received to the effect that [redacted] cannot be considered reliable, and this plus numerous inaccuracies in the [redacted] list are considered to render this information valueless.



UNITED STATES DEPARTMENT OF JUSTICE
FEDERAL BUREAU OF INVESTIGATION

In Reply, Please Refer to
File No.

Tampa, Florida

MAR 1 1961

ALL INFORMATION CONTAINED
HEREIN IS UNCLASSIFIED
DATE 02-23-2010 BY UC 60322 LP/STP/SZ

26TH OF JULY MOVEMENT
TAMPA, FLORIDA

[redacted] advised
that she is the [redacted]

[redacted] She advised that [redacted]
[redacted] is a Cuban citizen and
has been interested and involved in Cuban political and
revolutionary affairs all his adult life. She advised that
in 1954, he applied for U. S. Citizenship, [redacted]

FLA
GA

[redacted]

[redacted] In 1959, at
the end of the five year period when citizenship must be
granted or denied, [redacted] of INS was planning to
hold a hearing in Tampa regarding [redacted] petition,
but at the last minute [redacted] attorney advised him to
withdraw his request for citizenship.

b6
b7C
b7D

She advised that she was [redacted]

[redacted] just after FIDEL CASTRO gained power in
Cuba, and [redacted] He has since
[redacted] who works in
the Clinic. She advised that during the time she was [redacted]

Call
FLA

for the overthrow of BATISTA as the Tampa head of the
ORGANIZATION AUTENTICA (OA), so designated by [redacted]
former Cuban president CARLOS PRIO, and head of the JUNTA DE
LIBERACION, a coalition of all the anti-BATISTA groups, includ-
ing CASTRO's 26th of July. She advised [redacted]

[redacted] As a result she advised [redacted]

[redacted]

97-4455-10
ENCLOSURE

TP 97-2

[REDACTED]

She stated that it is her belief that the 26th of July Movement was formed to provide a nucleus of Communists throughout the hemisphere. She stated it was her opinion that all members of the 26th of July Movement, in Tampa and elsewhere were Communists. She stated that all the people who were active in the 26th of July Movement in Tampa, and hence were Communists, are now active in the FRENTE REVOLUCIONARIO DEMOCRATICO (FRD), [REDACTED] in Miami. She stated that the FRD is the second front of Communism.

CUBA

[REDACTED]

She stated that

[REDACTED]

b6
b7C
b7D

This "report", in the Spanish language, was determined to consist of several pages of generalized history of persons and groups active on behalf of CASTRO in Tampa particularly the 26th of July group in Tampa.

[REDACTED]

TP 97-2

[redacted]
[redacted] advised that, concerning the origin of these names and the source of the allegations.

b6
b7C
b7D

[redacted]

[redacted]
She advised that these names and the allegations concerning them are based on the above two incidents. However, she stated additionally that she is

[redacted]

She thereupon furnished the following supplemental information from memory concerning various persons named in this list.

She advised that [redacted] were very active in the 26th of July in Tampa since its inception in 1955.

CUBA
FLA

TP 97-2

[Redacted]

FLI
CUBA

[Redacted]

[Redacted]

FLI
CUBA

[Redacted]

FLI

b6
b7C
b7D

[Redacted]

FLI
CUBA

[Redacted]

FLI
CUBA

[Redacted]

CUBA

[Redacted]

[Redacted]

BA

[Redacted]

FLA
UBA

[Redacted]

FLA
UBA

[Redacted]

FLA
UBA

[Redacted]

b6
b7C
b7D

[Redacted]

[Redacted] advised that she came to know about these people and their activities during the time she was [Redacted] which was during the same time that [Redacted]

[Redacted] She advised she [Redacted]

[Redacted] shortly after CASTRO came to power and therefore [Redacted]

[Redacted]

[REDACTED]
[REDACTED] For example she did not know if [REDACTED] himself has engaged in any such activity since that time and did not know his present attitude, particularly in view of the fact that [REDACTED]
[REDACTED]

b6
b7C
b7D

This document contains neither recommendations nor conclusions of the FBI. It is the property of the FBI and is loaned to your agency; it and its contents are not to be distributed outside your agency.

2/21/61

PLAIN TEXT

AIRTEL

AIRMAIL

TO: DIRECTOR, FBI (97-4193)
FROM: SAC, TAMPA (97-1)

FAIR PLAY FOR CUBA COMMITTEE
RA - CUBA
IS - CUBA
(OO: NEW YORK)

*July 26, 1961 11:41 AM 117
TAMPA, FLA*

Reaytel 2/13/61.

b6
b7c

On 2/20/61, Detective [redacted] Tampa PD, advised that he had determined through a source that a meeting was to be held at a local Unitarian church building, rented for the purpose, at the corner of Eay to Eay Boulevard and Concordia Avenue, Tampa, to discuss a possible demonstration to protest recent statements of Florida's senator GEORGE SMATHERS, said meeting to be held on 2/22/61 and demonstration, if undertaken, on 2/24/61.

[redacted] said that he had information that an unknown Cuban doctor was coming to speak at the meeting. He said that he had also heard that [redacted] subject of Tampa [redacted]

This matter will be followed closely and the Bureau kept advised.

P

- 4 - Bureau (RM)
 - (1 - 97-4455)
 - (1 - 97-4219)
- 1 - New York (97-1752) (Info) (RM)
- 1 - Miami (Info) (RM)
- 5 - Tampa
 - (1 - 97-1)
 - (2 - 105-19)
 - (1 - 97-2)
 - (1 - 105-93)

SWJ:jn
(11)

97-4455
NOT RECORDED
183 MAR 1 1961

97-4196-350
ORIGINAL FILED IN

57 MAR 2 1961



2/13/61

AIRTEL

AIRMAIL

ALL INFORMATION CONTAINED
HEREIN IS UNCLASSIFIED
DATE 02-23-2010 BY UC 60322 LP/STP/SZ

TO: DIRECTOR, FBI (97-4196)

FROM: SAC, TAMPA (97-1)

**FAIR PLAY FOR CUBA COMMITTEE
RA - CUBA
IS - CUBA
(OO:NY)**

0 JULY 26TH MOVEMENT - TAMPA, FLA.

Rebulet 2/8/61 and Butel 2/9/61.

Information regarding possible demonstrations to be undertaken by captioned organization and 26th of July Movement was furnished to Det. [redacted] Tampa PD, in charge of Tampa Latin American activities, on 2/9/61, by SA [redacted]

Later on 2/9/61, Det. [redacted] advised SA [redacted] that he had learned from one of his sources that a tentative date has been set for a demonstration planned by captioned organization and the Patriotic Movement of Tampa. He said the date set is 2/24/61.

[redacted] said he would report to the FBI any further pertinent information he receives.

This matter will be followed closely and the Bureau kept advised of pertinent developments.

P

- 4 - Bureau (RM)
 - (1 - 97-4455)
 - (1 - 97-4210)
- 1 - New York (97-1792) (Info) (RM)
- 1 - Miami (Info) (RM)
- 5 - Tampa
 - (2 - 105-19)
 - (1 - 97-2)

HKR:cwp.
(11)

97-4455-

NOT RECORDED
60 FEB 17 1961

b6
b7c

97-4196-16

ORIGINAL FILED IN

59 FEB 23 1961

SAC, Tampa (97-2)

3/14/61

b6
b7c

Director, FBI (97-4455)

O
JULY 26TH MOVEMENT
TAMPA, FLORIDA
IS - CUBA

Reurlet 2/24/61.

Authority denied for utilization of thumbnail sketch of captioned organization as submitted by referenced letter pending following corrections:

The thumbnail sketch as furnished mentions three different sources but provides no identification of those sources as required.

Resubmit your contemplated thumbnail sketch to fully comply with instructions set out in Part II, Section 4, page 22, Item IV of the Manual of Rules and Regulations:

ERH:ct
(4)

ALL INFORMATION CONTAINED
HEREIN IS UNCLASSIFIED
DATE 02-23-2010 BY UC 60322 LP/STP/SZ

3 ENCLOSURE

REC-73

97-4455-512
11/20/61
SP/PR

19 MAR 13 1961

EX 101

- Tolson _____
- Parsons _____
- Mohr _____
- Belmont _____
- Callahan _____
- Conrad _____
- DeLoach _____
- Evans _____
- Malone _____
- Rosen _____
- Tavel _____
- Trotter _____
- W.C. Sullivan _____
- Tele. Room _____
- Gram _____
- Gandy _____

MAILED 8
MAR 13 1961
COMM-FBI

MAR 20 1961 *we* MAIL ROOM TELETYPE UNIT

PRH

UNITED STATES GOVERNMENT

Memorandum

TO : DIRECTOR, FBI (97-4455)

DATE: 2/24/61

FROM : SAC, TAMPA (97-2)

SUBJECT: JULY 26TH MOVEMENT
TAMPA, FLORIDA
IS-CUBA

Attached herewith as the second page of this letter is an amended characterization for captioned organization, amended to show that it has relinquished office space and reportedly ceased to exist.

UACB this characterization will be used in future reports.

2-Bureau
1-Tampa
RSC;rsc
(3)

ALL INFORMATION CONTAINED
HEREIN IS UNCLASSIFIED
DATE 02-23-2010 BY UC 60322 LP/STP/SZ

ENCLOSURE

ENCLOSURE

97-4455-11

Let - Tampa
4/4/61 ERH:CH

~~97-4455-11~~
~~NOT RECORDED~~
~~MAR 6 1961~~

NAT. SEC.

CONNECTION
NO ACTION

APPENDIX

JULY 26TH MOVEMENT
TAMPA, FLORIDA

According to an editorial appearing September 30, 1960 in La Gaceta, a Spanish Language weekly newspaper published at Tampa, Florida by VICTORIANO MANTEIGA, the 26th of July Movement or Club was founded November 27, 1955 at Tampa in the presence of Dr. FIDEL CASTRO, and subsequently, when CASTRO was fighting in Cuba, issued propaganda and collected donations for the revolutionaries. According to other articles appearing in this newspaper and source in a position to know, MANTEIGA was president and directed this Club, variously known as the 26th of July Club, 26th of July Movement, the Club Patriotic 26 de Julio and other variations and translations, for a number of years. Until January, 1961 the club maintained office space at 1318 9th Avenue, Tampa, Florida.

A source in a position to know advised that after CASTRO gained power in Cuba in January, 1959, a number of persons active in the captioned group returned to Cuba and assumed positions of varying importance in the CASTRO government. Subsequently, according to another source who has furnished reliable information in the past and who was in a position to know, the Tampa 26th of July Movement has diminished in size, importance and activity. He was told by an officer of the Movement in December, 1960 that the Movement had ceased to exist. The office space was relinquished January 15, 1961.

ENCLOSURE

97-4455-11

~~CONFIDENTIAL~~
P
REP

0

UNITED STATES

Memo

TO : DIRECTOR, FBI (97-4455)

DATE: 3/15/61

FROM : SAC, TAMPA (97-2)

EXEMPTED FROM AUTOMATIC
DECLASSIFICATION
AUTHORITY DERIVED FROM:
FBI AUTOMATIC DECLASSIFICATION GUIDE
EXEMPTION CODE 25X(1-HUMAN/AAG)
DATE 02-23-2010

SUBJECT: JULY 26TH MOVEMENT
TAMPA, FLORIDA
IS-CUBA

Rebulet to Tampa 3/14/61.

Attached herewith as second page of this letter is amended thumbnail sketch for captioned organization for which Bureau authority is sought. UACB Tampa will utilize this amended characterization.

- 2-Bureau
- 2-Tampa (1 97-2
1 Thumbnail file)

MB

RSC:rsc
(4)

ALL INFORMATION CONTAINED
HEREIN IS UNCLASSIFIED EXCEPT
WHERE SHOWN OTHERWISE

Copy to Tampa
by routing slip for
 info action
date 3-23-61
by ERH/peo

EX 104
REC 19

REC-91

97-4455-12
9 MAR 17 1961

NAT. SEC.

APPROVED

DATE 3-23-61

FBI
REC-11A SEC1

MB 55 3 SH BH 81

RECEIVED

63 MAR 24 1961

Mail Room

~~CONFIDENTIAL~~

JULY 26TH MOVEMENT
TAMPA, FLORIDA

According to an editorial appearing September 30, 1960 in La Gaceta, a Spanish language weekly newspaper published at Tampa, Florida, by VICTORIANO MANTEIGA, the 26th of July Movement or Club was founded November 27, 1955 at Tampa in the presence of Dr. FIDEL CASTRO, and subsequently, when CASTRO was fighting in Cuba, issued propaganda and collected donations for the revolutionaries. According to other articles appearing in this newspaper and source in a position to know, MANTEIGA was president and directed this Club, variously known as the 26th of July Club, 26th of July Movement, the Club Patriotico 26 de Julio and other variations and translations, for a number of years. Until January, 1961 the club maintained office space at 1318 9th Avenue, Tampa, Florida.

A source in a position to know advised that after CASTRO gained power in Cuba in January, 1959, a number of persons active in the captioned group returned to Cuba and assumed positions of varying importance in the CASTRO government. Subsequently, according to another source in a position to know, the Tampa 26th of July Movement has diminished in size, importance and activity. He was told by an officer of the Movement in December, 1960, that the Movement had ceased to exist. Their office space was relinquished January 15, 1961.

b6
b7C
b7D

(C) The first two references to sources above refer to PSI. [redacted]

[redacted] who has furnished reliable information concerning it. The latter reference to source concerns former PSI [redacted] who has furnished reliable information in the past.

b1

3/17/61

SAC, Tampa

Director, FBI

ALL INFORMATION CONTAINED
HEREIN IS UNCLASSIFIED
DATE 02-23-2010 BY UC 60322 LP/STP/SZ

REGISTRATION ACT - CUBA

Reurlet 3/1/61 captioned "July 26th Movement,
Tampa, Florida," with enclosure.

In view of the admission by subject that she is
[redacted] you should submit a separate
report on her in accordance with instructions contained in
Bulet to LMI 10/26/60 captioned "Anti-Fidel Castro Activities,"
copies of which were furnished your office. See last
paragraph, page 2, of this letter.

b6
b7C
b7D

1 - 97-4455 (July 26th Movement, Tampa, Florida)

VHN:njpcct
(5)

NOTE: Subject on interview admitted she was [redacted]

[redacted] Bulet to LMI 10/26/60 advised that in connection
with possible obligation to register of possible violation
of Registration Act by anti-Castro individuals where this
is the primary basis of investigation, the office of origin
should obtain basic facts and submit closing report. In
view of subject's admission she is [redacted] we
should follow this procedure.

97-4455-

NOT RECORDED
60 MAR 21 1961

MAILED 10
MAR 16 1961
COMM-FBI

- Olson _____
- Wesons _____
- Mohr _____
- Belmont _____
- Callahan _____
- Conrad _____
- DeLoach _____
- Evans _____
- Malone _____
- Rosen _____
- Tavel _____
- Trotter _____
- W.C. Sullivan _____
- Tele. Room _____
- Ingram _____
- Gandy _____

XEROX
MAR 21 1961
VPC

19 MAR 20 1961

51 MAR 23 1961

MAIL ROOM TELETYPE UNIT

ORIGINAL FILED IN
97-4541

~~CONFIDENTIAL~~
FEDERAL BUREAU OF INVESTIGATION

Reporting Office TAMPA	Office of Origin TAMPA	Date 4/17/61	Investigative Period 2/10 - 4/5/61
TITLE OF CASE THE JULY 26th MOVEMENT TAMPA, FLORIDA		Report made by SA [redacted]	Typed By: ms
		CHARACTER OF CASE IS - CUBA ALL INFORMATION CONTAINED RA - CUBA HEREIN IS UNCLASSIFIED EXCEPT WHERE SHOWN OTHERWISE b6 b7C	

ST
WLO
3
4
5
6
10
11
12

REFERENCES: Report of SA [redacted] 2/2/61, Tampa.
Tampa letter to Bureau 3/1/61.
Tampa airtel to Bureau 3/20/61.

LEADS:
TAMPA DIVISION
AT TAMPA, FLORIDA

EXEMPTED FROM AUTOMATIC
DECLASSIFICATION
AUTHORITY DERIVED FROM:
FBI AUTOMATIC DECLASSIFICATION GUIDE
EXEMPTION CODE 25X(1-HUMAN)/AAC
DATE 02-22-2010

1. Tampa will through logical sources attempt to determine if pro-CASTRO Cubans are meeting at unknown dairy barn and if so identify the barn and the group meeting there.

2. Will, if it is determined that captioned group is holding meetings again, investigate and report results.

Approved <i>Jurb</i> Special Agent in Charge	Do not write in spaces below
Copies made: 9 - Bureau (97-4455) (RM) 1 - INS, Miami (RM) 1 - ONI, Charleston, S.C. (RM) 1 - G-2, Ft. McPherson, Ga. (RM) 1 - 11th CIC Group, Orlando, Fla. (RM) 1 - OSI, Robins. AFB, Ga. (RM) 3 - Tampa (97-2)	97-4455-13 (ST REC-6) 14 APR 20 1961

Copy to: CIA/State/RAB
ONI/OSI/GZ/7AC
by routing slip for info
Date 4-25-61 by ERH/pea

NATIONAL SEC.

55 APR 26 1961

~~CONFIDENTIAL~~

~~SECRET~~

TP 97-2

ADMINISTRATIVE

This report is being classified ~~confidential~~ inasmuch as it contains information furnished by informants of lasting value whose investigative effectiveness would be impaired if such information were disclosed. The information furnished by [redacted]

[redacted] which is contained herein is in connection with information furnished by [redacted]

[redacted] information consists of a history of the July 26th Movement in Tampa, considered relatively accurate, plus a list of names of persons in Tampa termed Communist or Agents of the Cuban DIER. This list of names is almost identical to a similar list furnished this office by PSI [redacted] except that [redacted] furnished the list as being the identities of pro-CASTRO individuals in Tampa [redacted]

[redacted] stated he made up this list from his own knowledge and furnished a copy to [redacted]

b6
b7C
b7D

The "report" produced by [redacted] referred to herein, was examined by SA [redacted] and determined to be an identical Spanish language version of the report furnished by the [redacted] and therefore was not reproduced herein.

[redacted] during the course of this interview, stated she made up this list from information [redacted] and from her own knowledge. She stated that she furnished a copy of this list to [redacted]

She stated that both she and [redacted]

TP 197-2

It is noted that [redacted] furnished his list to this office on the early afternoon of October 13, 1960. According to information from Miami, the raid on the Cuban Consulate there, which [redacted]

[redacted] occurred about noon on October 13, 1960. [redacted]

[redacted] Furthermore, Miami has advised that a supposed list of persons obtained in the raid on the consulate in Miami has been circulated about and is considered to have no value.

The above is to substantiate information previously received to the effect that [redacted] can not be considered reliable and this plus numerous inaccuracies in the [redacted] list are considered to render this information valueless.

b6
b7C
b7D

INFORMANTS

Identity

Location of Information

TP T-1 is PSI [redacted]

[redacted] and 97-2-98

TP T-2 is [redacted]

97-2-87

[redacted]

[redacted] (requested).

b6
b7C
b2
b7D

TP T-3 is PSI, [redacted]

[redacted]

TP 97-2

TP T-4 is PSI [redacted] [redacted]

TP T-5 is [redacted] 97-2-106

[redacted]
(requested)

TP T-6 is CS [redacted] [redacted]
[redacted]

TP T-7 is [redacted] TP 97-2-49

[redacted]
[redacted] (request)

b6
b7C
b2
b7D

(C)

Sources utilized in the characterization of the July 26th Movement appearing in the Appendix hereto are PSI [redacted] and former PSI [redacted]

b1

Careful consideration has been given to each source concealed, and T symbols were used only in those instances where the identity of these sources must be concealed.

D*
(Cover Page)

UNITED STATES DEPARTMENT OF JUSTICE
FEDERAL BUREAU OF INVESTIGATION

~~CONFIDENTIAL~~

Copy to: 1 - INS, Miami (RM)
1 - ONI, Charleston, S.C. (RM)
1 - G-2, Ft. McPherson, Ga. (RM)
1 - 111th CIC Group, Orlando, Fla. (RM)
1 - OSI, Robins AFB, Ga. (RM)

Report of: SA [redacted]
Date: 4/17/61

Office: TAMPA

b6
b7C

Field Office File #: 97-2

Bureau File #: 97-4455

Title: THE JULY 26th MOVEMENT
TAMPA, FLORIDA

DECLASSIFICATION AUTHORITY DERIVED FROM:
FBI AUTOMATIC DECLASSIFICATION GUIDE
DATE 02-23-2010

Character: INTERNBASECURITY - CUBA
REGISTRATION ACT OF CUBA

Synopsis: Information received from informants, Tampa, July 26th Movement possibly moving toward reactivation. Investigation and interviews of former members fail to reflect that group as actually reactivated or is holding meetings. Photograph of July 26th Movement group, as of 3/27/59, obtained. Information regarding bank account previously maintained set forth. [redacted] interviewed on 2/10/61. Information concerning history of the July 26th Movement, and members and associates furnished by [redacted] set forth as background information. Reliability of [redacted] questionable.

b6
b7C
b7D

- P -

DETAILS: AT TAMPA, FLORIDA

Information Reflecting
Possible Reactivation
of July 26th Movement,
Tampa, Florida

On February 16, 1961, TP T-1 advised that a group of people held a meeting on the evening of [redacted] at the home of [redacted]. TP T-1 advised that inasmuch as those present were largely Cubans, it appeared that it was meeting of the July 26th Movement.

b6
b7C

~~CONFIDENTIAL~~

TP 97-2

A characterization of the July 26th Movement appears in the Appendix to this report.

On February 21, 1961, TP T-2 advised that he had received information that the July 26th Movement had held some meetings [redacted]

TP T-3 advised on February 17, 1961 that a meeting of some kind took place the preceding Sunday at 1:00 [redacted]

TP T-3 advised [redacted]

On March 1, 1961, TP T-1 advised that he had inferred that the group of people who were at the home of [redacted] on the evening of [redacted] were there for a meeting of the July 26th Movement. Informant advised that he deduced this because of [redacted] background in these activities. Source said [redacted]

b6
b7C
b7D

[redacted] He stated he had no evidence or concrete information that the July 26th Movement has held meetings in Tampa since the abandonment of its headquarters shortly after the 1st of January, 1961. TP T-1 advised he doubts this group has held any meetings officially.

On March 1, 1961, [redacted] advised he is presently [redacted] said that he [redacted] on December 11, 1960 and has [redacted] since about that time.

[redacted] advised that there have not been any meetings of any group of any kind in this establishment since he has been operating it. He said he would not allow any to be held here and has never been approached to do so.

TP 97-2

[redacted] noted that the area is extremely restricted and in no way would serve as a meeting place. [redacted] said that no meetings were ever held here to his knowledge and doubts that any were ever held in the [redacted]
[redacted]

[redacted] said he has never belonged to any pro-CASTRO group and is not interested in doing so.

Tampa, Fla
On April 5, 1961, [redacted] *Cu int*
[redacted] advised that he was never a member of the July 26th Movement. [redacted] said he has never been a member of the Communist Party and that he does not know what constitutes Communism. [redacted] said that there never has been a meeting of any pro-CASTRO group held at this address to the best of his knowledge. [redacted] said that [redacted] who also lives at this address [redacted] *Tampa, Fla*
was a former member of the July 26th Movement. [redacted] said [redacted]

[redacted] said he plans to go to Cuba at a future date with [redacted] for a visit.

b6
b7c

The Communist Party has been designated by the Attorney General of the U. S. pursuant to Executive Order 10450.

On February 27, 1961, [redacted]
[redacted] Tampa, Florida was interviewed concerning his activities in relation to the July 26th Movement. [redacted] advised that he had been a member of the July 26th Movement during the early stages of its organization and development.

[redacted] advised that he left the organization approximately 7 months prior to this interview and has not returned to activity in the group and has divorced himself completely from it.

TP 97-2

[redacted] advised he has no knowledge of the present activities of the July 26th Movement. He said that to the best of his knowledge it has been completely disbanded. He said that as far as he knows, it has no headquarters, officials or meeting place.

On March 14, 1961, [redacted] Tampa, advised that he was formerly [redacted]
[redacted]
[redacted]

[redacted] advised that the offices of the July 26th Movement were closed on about January 1, 1961. [redacted] advised that many members of the group had become dissatisfied prior to the closing of the offices and had disassociated themselves from the group. [redacted] advised that the July 26th Movement was disorganized and has become completely defunct to the best of his knowledge. He said that as far as he knows there are no activities of the group being carried on presently, either overtly or secretly.

b6
b7C

[redacted] stated that he feels many of the old members broke away because of the Communistic tendencies of CASTRO and the CASTRO Government in Cuba. He said he believes this was a major reason for the disbanding of the organization of the July 26th Movement.

The July 26th Movement formerly maintained its headquarters at 2006 Avenida Republica de Cuba. To date, this space remains unoccupied.

On January 13, 1961, "La Gadeta", Spanish weekly newspaper of Tampa edited by VICTORIANO MANTEIGA, who has reportedly served as President of the July 26th Movement, published an item in the form of a letter addressed to the people of Tampa disbanding the July 26th Movement in Tampa as of that date. The article explained that all members of the Movement were in complete accord with the dissolution of the club and gave as their reason the recent break in diplomatic relations between the U.S. and Cuba. The article was signed by the July 26th Movement of Tampa. F. L. G.

TP 97-2

On March 2, 1961, CARLOS/CARBONELL advised that he was Secretary of the Tampa July 26th Movement from the visit of FIDEL CASTRO to Tampa in 1955 until January 9, 1961 when the organization was disbanded. Throughout this same period VICTORIANO MANTEIGA has been President and RAUL VILLAMIA, Secretary General. CARBONELL advised that after CASTRO gained power in January 1959 there was no longer any need for the Tampa July 26th Movement and thereafter the club existed only for symbolical reasons and had no regular meetings or activities, except those of a commemorative nature, such as placing wreaths on the statue of JOSE MARTI on Cuban holidays. He said they had no regular meetings or dues and the rent and expenses were met by special collections as needed. FLA

CARBONELL advised that on January 9, 1961, it was decided at an informal meeting of those active in the group to disband and terminate the group because of repeated vandalism to their offices. FLA

On March 31, 1961, TP T-6 advised that [redacted]

[redacted]
[redacted] TP T-6 advised that [redacted] has stated he will [redacted]

b6
b7C
b7D

Photograph of July 26th
Movement Group

On February 14, 1961, TP T-4 furnished a copy of the Tampa Spanish Language weekly newspaper, La Gaceta, dated March 27, 1959. On the front page of this edition appears a photograph of a group of individuals, with the caption (in Spanish) "Photograph of the 26th of July Movement of Tampa". The legend under the photograph stated "All those who appear here are members of the 26th of July Movement of Tampa. Seated from left to right, [redacted]

[redacted] standing [redacted]

TP 97-2

members of Subject Organization Tampa, FLA

from left to right, [redacted]

[redacted]

b6
b7C

Not appearing in this photograph are [redacted]

[redacted] It is felt that the above constitutes a membership list of the Tampa July 26th Movement as of March 27, 1959.

Financial Information
Concerning Tampa July 26th
Movement

On February 21, 1961, during the course of investigation at the [redacted] [redacted] were made available for examination by TP T-5 and the following information pertaining to instant organization was noted.

Records of the [redacted]

[redacted]

b7D

[redacted]

[redacted]

[redacted]

[redacted]

TP 97-2

[REDACTED]

The foregoing records are available upon the issuance of a subpoena duces tecum directed to [REDACTED]

b6
b7C
b7D

[REDACTED]

Background Information
Concerning July 26th
Movement and Reported
Associations.

[REDACTED] advised on February 10, 1961, that she is the [REDACTED]

[REDACTED] She advised that [REDACTED] is a Cuban citizen and has been interested and involved in Cuban political and revolutionary affairs all his adult life. She advised that in 1954, he applied for U. S. Citizenship, [REDACTED]

[REDACTED] In 1959, at the end of the five year period when citizenship must be granted or denied, [REDACTED] of INS was planning to hold a hearing in Tampa regarding [REDACTED] petition, but at the last minute [REDACTED] attorney advised him to withdraw his request for citizenship.

b6
b7C

She advised that she was [REDACTED]

[REDACTED] just after FIDEL CASTRO gained power in Cuba, and [REDACTED] He has since [REDACTED] who works in [REDACTED] She advised that during the time she was [REDACTED] he was extremely

TP 97-2

active in working for the overthrow of BATISTA [redacted]
[redacted] so designated by
his good friend [redacted]
[redacted] a coalition of all the anti-
BATISTA groups, including CASTRO's 26th of July. She advised
[redacted] As
a result she advised [redacted]

b6
b7C
b7D

She stated that it is her belief that the 26th of July Movement was formed to provide a nucleus of Communists throughout the hemisphere. She stated it was her opinion that all members of the 26th of July Movement, in Tampa and elsewhere were Communists. She stated that all the people who were active in the 26th of July Movement in Tampa, and hence were Communists, are now active in the FRENTE REVOLUCIONARIO DEMOCRATICO (FRD), headed by TONY VARONA in Miami. She stated that the FRD is the second front of Communism. [redacted]

[redacted]

She stated that [redacted]

[redacted]

b6
b7C
b7D

TP 97-2

This "report", in the Spanish language, was determined to consist of several pages of generalized history of persons and groups active on behalf of CASTRO in Tampa, particularly the 26th of July group in Tampa. [redacted]

[redacted]

[redacted] advised that, concerning the origin of these names and the source of the allegations, [redacted]

[redacted]

b6
b7C
b7D

[redacted]

TP 97-2

She advised that these names and the allegations concerning them are based on the above two incidents. However, she stated additionally that she is [redacted]

[redacted]

She thereupon furnished the following supplemental information from memory concerning various persons named in this list.

She advised that [redacted] were very active in the 26th of July in Tampa since its inception in 1955.

b6
b7C
b7D

MOVEMENT

[redacted]

[redacted]

FAA

[redacted]

[redacted]

TP 97-2

[Redacted]

[Redacted]

SUBJECT ORGANIZATION

[Redacted]

b6
b7C
b7D

FAA

[Redacted]

See 67

[Redacted]

[Redacted]

FAA

TP 97-2

[Redacted]

F + A

[Redacted]

[Redacted]

[Redacted]

F + A b6
b7C
b7D

interview
[Redacted] advised that she came to know about these people and their activities during the time she was [Redacted] which was during the same time that he was actively engaged in efforts to bring about the overthrow of the BATISTA government. She advised she [Redacted] shortly after CASTRO came to power and therefore [Redacted]

[Redacted]

[Redacted] For example she did not know if [Redacted] himself has engaged in any such activity since that time and did not know his present LES-
~~attitude~~ particularly in view of the fact that he was

b6
b7C
b7D

[Redacted]

TP T-7 advised November 30, 1960, that she has [Redacted]

[Redacted] She stated she likes [Redacted] but has found that little credence can be put in anything she has to say.



UNITED STATES DEPARTMENT OF JUSTICE

FEDERAL BUREAU OF INVESTIGATION

In Reply, Please Refer to
File No.

Tampa, Florida
April 17, 1961

Title: The July 26th Movement
Tampa, Florida

Character: IS - CUBA
RA - CUBA

Reference: Report SA
dated and captioned as
above.

b6
b7C

All sources (except any listed below) used in referenced communication have furnished reliable information in the past.

TP T-2, TP T-3 and TP T-7 with whom contact has been insufficient to determine their reliability.

This document contains neither recommendations nor conclusions of the FBI. It is the property of the FBI and is loaned to your agency; it and its contents are not to be distributed outside your agency.

DIRECTOR, FBI (109-551)

4/9/61

SAC, TAMPA (97-2)

JULY 26th MOVEMENT - Tampa, Florida
INTERNAL SECURITY - CUBA
REGISTRATION ACT - CUBA

Re Bureau letter to New York, 3/31/61.

Set forth below is the information regarding the Tampa Office's live informant coverage of captioned organization as requested in re letter.

(It is noted that the dissolution of captioned group was reported in the closing report of SA [redacted] at Tampa, captioned as above, and dated 2/2/61, as occurring just prior to January 15, 1961. To date, investigation has failed to reflect that the July 26th Movement has reactivated in this area.)

b6
b7C

- | I. ESTABLISHED SOURCES AND INFORMANTS (CUBA) | <u>Total</u> |
|--|--------------|
| | 6 |
| (a) TP 1-S, Bufile 100-379740
(Information re names of former members and activities.) | |
| (b) TP 27-S, Bufile 100-390202
(Information re names of former members and activities.) | |
| (c) C.S. [redacted]
[redacted] (Information re names of former members and activities.) | |

b6
b7C
b2
b7D

ORIGINAL FILED IN 109-551-

P

3 - Bureau (109-551)
2 - Tampa (97-2)

SWJ:blp
(5)

97-4455-

NOT RECORDED

APR 20 1961

56 APR 21 1961

- (d) [redacted] (Information re those former members who seek medical aid.)
- (e) [redacted] (General information re former members.)
- (f) C.S. [redacted] Bufile 100-372393, (Information re names of former members, their whereabouts, and activities.)

ii. POTENTIAL SOURCES OF INFORMATION

Total
6

- (a) PSI [redacted] (Information re names of former members, their whereabouts, and activities.)
- (b) PSI [redacted] (Information re names of former members, their whereabouts, and activities.)
- (c) PSI [redacted] (Information re names of former members, their whereabouts, and activities.)
- (d) PSI [redacted] (Information of general nature concerning July 26th Movement and former members.)

b6
b7C
b2
b7D

(e) PSI [redacted]
[redacted] (General
information.)

(f) PSI [redacted]
[redacted] (Information
re former members, whereabouts,
and past and present activities.)

b6
b7C
b2
b7D

III: MEMBERS OF JULY 26th MOVEMENT INTERVIEWED DURING LAST MONTH	<u>Total</u>
(a) Cooperative and having potential as source.	0
(b) Having no informant or source potential.	7
(c) Uncooperative	0

FEDERAL BUREAU OF INVESTIGATION

REPORTING OFFICE TAMPA	OFFICE OF ORIGIN TAMPA	DATE JUN 8 1961	INVESTIGATIVE PERIOD 4/11-6/1/61
TITLE OF CASE THE JULY 26TH MOVEMENT, TAMPA, FLORIDA		REPORT MADE BY [Redacted]	TYPED BY jn
		CHARACTER OF CASE IS - CUBA RA - CUBA	

b6
b7c

REFERENCE: Report of SA [Redacted] dated 4/17/61, at Tampa.

- P -

LEADS

TAMPA

AT TAMPA, FLORIDA

1. Will continue to develop information concerning subject organization through interview of former members of this organization and interviews of persons connected with related matters.
2. Will continue to investigate to determine if subject organization has moved toward possible reactivation.

ADMINISTRATIVE

This report is being classified confidential inasmuch as it contains information furnished by TP-T-2, an informant of lasting value.

APPROVED <i>[Signature]</i>	SPECIAL AGENT IN CHARGE	DO NOT WRITE IN SPACES BELOW	
COPIES MADE: <ul style="list-style-type: none"> 9 - Bureau (97-4455) (RM) 1 - INS, Miami (RM) 1 - ONI, Charleston, S. C. (RM) 1 - G-2, Ft. McPherson, Ga. (RM) 1 - CIC, Orlando, Florida (RM) 1 - OSI, Robin AFB, Ga. (RM) 3 - Tampa (97-2) 		97-4455-16	REC-17
		16 JUN 12 1961	EX-113
Dissemination Record of Attached Report		Notations	
Agency	Copy to: CIA/State/RAB ONI/OSI/IG2/IAAC	NAT. INT. SEC.	
Request Recd.			
Date Fwd.	by routing slip for info		
How Fwd.	Date 6-14-61 by CEH/ale		
By			

ALL INFORMATION CONTAINED HEREIN IS UNCLASSIFIED EXCEPT WHERE SHOWN OTHERWISE

56 JUN 14 1961 *[Signature]* F246

TP 97-2

value, whose investigative effectiyeness would be impaired if such information were disclosed.

INFORMANTS

IDENTITY

LOCATION OF ORIGINAL INFORMATION

TP T-1 is [redacted]
Tampa, Florida
(Requested)

97-2-127

b6
b7C
b2
b7D

TP T-2 is [redacted]

[redacted]

TP T-3 is [redacted]
Tampa, Florida

[redacted]

Sources utilized in the characterization of the July 26th Movement appearing in the appendix of this report are:

(C) PSI [redacted]
Former PSI [redacted]

b1

Careful consideration has been given to each source. concealed and T symbols were used only in those instances where the identity of these sources must be concealed.

CONFIDENTIAL

UNITED STATES DEPARTMENT OF JUSTICE
FEDERAL BUREAU OF INVESTIGATION

DECLASSIFICATION AUTHORITY DERIVED FROM:
FBI AUTOMATIC DECLASSIFICATION GUIDE
DATE 02-23-2010

Copy to: 1 - INS, Miami (RM)
1 - ONI, Charleston, S. C. (RM)
1 - G-2, Ft. McPherson, Ga. (RM)
1 - CIC, Orlando, Fla. (RM)
1 - OSI, Robin AFB, Ga. (RM)

Report of: SA [REDACTED]
Date: JUN 8 1961

Office: TAMPA

Field Office File #: TP 97-2

Bureau File #: 97-4455

Title: THE JULY 26TH MOVEMENT,
TAMPA, FLORIDA

b6
b7C

Character: INTERNAL SECURITY-- CUBA
REGISTRATION ACT - CUBA

Synopsis: Former Secretary General of July 26th Movement in Tampa interviewed on 4/11/61 and advised Movement organized in Tampa by FIDEL CASTRO in 1955. He advised the group maintained headquarters at 14th Street and 9th Avenue, Tampa, until the severance of diplomatic relations between the U. S. and Cuba, and has ceased to exist since that time in Tampa. He advised original purpose of group was to aid Cubans in overthrow of BATISTA and continued after CASTRO attained power to collect clothing for poor of Cuba. Former Secretary of Propaganda of this group advised 5/23/61 that July 26th completely discontinued. Former member interviewed 5/17/61, advised July 26th now defunct in Tampa. Informants advised group not presently holding meetings.

- P -

DETAILS: AT TAMPA, FLORIDA

RAUL VILLAMIA, 2718 Collins Street, Tampa, Fla former Secretary General of the July 26th Movement in Tampa, advised on April 11, 1961, that the July 26th Movement was organized in Tampa upon the visit of FIDEL CASTRO to Tampa in 1955. The group maintained its headquarters in an office at 14th Street and 9th Avenue, Tampa. VILLAMIA advised that on the day the United States severed diplomatic relations with Cuba, a group of anti-CASTRO people broke into their office and destroyed the furniture. He said the July 26th Movement members decided to disband, and the organization has ceased to exist since that time. VILLAMIA said the group was originally formed to help the people of Cuba overthrow the Dictator BATISTA. After FIDEL CASTRO successfully gained control in Cuba, the group continued to exist to collect clothing for the poor people of Cuba.

This document contains neither recommendations nor conclusions of the FBI. It is the property of the FBI and is loaned to your agency; it and its contents are not to be distributed outside your agency.

CONFIDENTIAL

A characterization of the July 26th Movement appears in the appendix hereto.

On May 23, 1961, RAY DELGADO, [redacted] Tampa, former Secretary of Propaganda of subject organization, advised that he knows of no plans of the former members of the Movement to reactivate, nor of any meetings presently being held by this group. He said that as far as he knows, the July 26th Movement in Tampa has been completely discontinued.

b6
b7C

FIA
On May 17, 1961, ARMANDO DIAZ RAMIREZ, [redacted] Tampa, advised that he was a member of the Tampa July 26th Movement prior to the break-off in relations between the United States and Cuba. DIAZ stated that the July 26th Movement became disbanded in January, 1961, and is now defunct. He said that it holds no meetings presently to the best of his knowledge.

On May 25, 1961, TP T-1 advised that he [redacted] He stated that he has [redacted] TP T-1 said that there is no active July 26th Movement in Tampa at present to the best of his knowledge. TP T-1 is in a position to [redacted]

b6
b7C
b7D

On April 27, 1961, TP T-2 advised that [redacted] who is associated with the Cuban situation in Tampa, had indicated that the July 26th Movement is no longer in existence and had disbanded because of continuing attacks against the organization and its meeting place by anti-CASTRO elements.

FIA.

TP T-3 advised on May 17, 1961, that he had attempted to determine if subject organization was holding meetings in a dairy barn in the Tampa vicinity, in order to verify rumors to that effect. He said he has not been able to locate this rumored meeting place of the July 26th Movement and doubts that any exists.

~~CONFIDENTIAL~~APPENDIXJULY 26TH MOVEMENT, TAMPA, FLORIDA

According to an editorial appearing September 30, 1960, in "La Gaceta," a Spanish language weekly newspaper published at Tampa, Florida, by VICTORIANO MANTEIGA, the July 26th Movement or Club was founded November 27, 1955, at Tampa in the presence of Dr. FIDEL CASTRO, and subsequently, when CASTRO was fighting in Cuba, issued propaganda and collected donations for the revolutionaries. According to other articles appearing in this newspaper, MANTEIGA was president and directed this club, variously known as the 26th of July Club, 26th of July Movement, the Club Patriotico 26 de Julio and other variations and translations, for a number of years. Until January, 1961, the club maintained office space at 1318 9th Avenue, Tampa, Florida.

A source in a position to know advised that after CASTRO gained power in Cuba, in January, 1959, a number of persons active in the captioned group returned to Cuba and assumed positions of varying importance in the CASTRO government. Subsequently, according to another source in a position to know, the Tampa July 26th Movement diminished in size, importance and activity. He was told by an officer of the Movement in December, 1960, that the Movement had ceased to exist. Their office space was relinquished January 15, 1961.

On January 13, 1961, "La Gaceta" carried an item in the form of a letter addressed to the people of Tampa disbanding the July 26th Movement in Tampa as of that date by common accord of all members.

The following, who served as officers of captioned organization, advised on the dates indicated that the July 26th Movement in Tampa is dissolved and at present conducts no activities, either openly or covertly:

RAUL VILLAMIA, Secretary General, on April 11, 1961;
FLORENTINO SANTOS, Treasurer, on March 14, 1961;
CARLOS CARBONELL, Secretary, on March 2, 1961.

~~CONFIDENTIAL~~



UNITED STATES DEPARTMENT OF JUSTICE

FEDERAL BUREAU OF INVESTIGATION

Tampa, Florida

In Reply, Please Refer to
File No.

TP 97-2

JUN 8 1961

TITLE THE JULY 26TH MOVEMENT,
TAMPA, - FLORIDA

CHARACTER INTERNAL SECURITY - CUBA
REGISTRATION ACT - CUBA

REFERENCE Report of SA [REDACTED]
captioned and dated as above.

b6
b7C

All sources (except any listed below) used in referenced communication have furnished reliable information in the past.

Insufficient contact has been had with TP T-1 and [REDACTED] to determine their reliability.

This document contains neither recommendations nor conclusions of the FBI. It is the property of the FBI and is loaned to your agency; it and its contents are not to be distributed outside your agency.

b2
b7D

DIRECTOR, FBI (109-551)

6/5/61

SAC, TAMPA (97-2)

~~JULY 26th MOVEMENT~~ Tampa

IS - CUBA

RA - CUBA

Reylet, dated 5/9/61.

Set forth below is the information regarding the Tampa Office's current live informant coverage of captioned organization. (Dissolution of captioned group has been reported previously. Investigation to date fails to reflect renewed activity on part of subject organization.)

- | | | |
|--|-------|---|
| 1. ESTABLISHED SOURCES AND INFORMANTS (CUBA) | Total | 5 |
| 2. POTENTIAL SOURCES OF INFORMATION | Total | 5 |
| 3. MEMBERS OF JULY 26th MOVEMENT INTERVIEWED DURING LAST MONTH | Total | 9 |
| (a) Cooperative and having potential as source | Total | 7 |
| (b) Having no informant or source potential | | 2 |
| (c) Uncooperative | | 0 |

For the information of the Bureau, the following named individuals, which have informant potential relating to coverage of this matter, have been opened for appropriate background investigation:

- P
- 2 - Bureau
 - 2 - Tampa

SWJ:ew
(4)

NOT RECORDED
87 JUN 19 1961

50 JUN 12 1961

ORIGINAL FILED IN 109-551-243

TP 97-2

(a) [redacted] as an PSI.

(b) [redacted] as a PSI.

(c) [redacted] as a PSI.

b6
b7C
b2
b7D

In addition, [redacted] Bufile 105-93665,
[redacted] is being considered for
utilization as a Security Source.

~~CONFIDENTIAL~~

EXEMPTED FROM AUTOMATIC
DECLASSIFICATION
AUTHORITY DERIVED FROM:
FBI AUTOMATIC DECLASSIFICATION GUIDE
EXEMPTION CODE 25X(1-HUMAN/AAG)
DATE 02-23-2010

ALL INFORMATION CONTAINED
HEREIN IS UNCLASSIFIED EXCEPT
WHERE SHOWN OTHERWISE

Letter from Sac, Tampa 5/15/61 Re: Subversive Organizations

JULY 26TH MOVEMENT, TAMPA, FLORIDA

Tampa File 97-2 BuFile 97-4455

According to an editorial appearing September 30, 1960, in La Gaceta, a Spanish language weekly newspaper published at Tampa, Florida, by VICTORIANO MANTEIGA, the July 26th Movement or Club was founded November 27, 1955, at Tampa in the presence of Dr. FIDEL CASTRO, and subsequently, when CASTRO was fighting in Cuba, issued propaganda and collected donations for the revolutionaries. According to other articles appearing in this newspaper, MANTEIGA was president and directed this club; variously known as the 26th of July Club, 26th of July Movement, the Club Patriotico 26 de Julio and other variations and translations, for a number of years. Until January, 1961, the club maintained office space at 1318 9th Avenue, Tampa, Florida.

A source in a position to know advised that after CASTRO gained power in Cuba, in January, 1959, a number of persons active in the captioned group returned to Cuba and assumed positions of varying importance in the CASTRO government. Subsequently, according to another source in a position to know, the Tampa July 26th Movement diminished in size, importance and activity. He was told by an officer of the Movement in December, 1960, that the Movement had ceased to exist. Their office space was relinquished January 15, 1961.

On January 13, 1961, La Gaceta carried an item in the form of a letter addressed to the people of Tampa disbanding the July 26th Movement in Tampa as of that date by common accord of all members.

The following, who served as officers of captioned organization, advised on the dates indicated that the July 26th Movement in Tampa is dissolved and at present conducts no activities, either openly or covertly:

APPROVED **MAY 23 1961**
Date

97-4455-
NOT RECORDED
185, MAY 18 1961

66 MAY 29 1961

~~56 MAY 26 1961~~

~~CONFIDENTIAL~~

ORIGINAL FILED IN 100-7254-3205

Handwritten signatures and initials

RAUL VILLAMIA, Secretary General,
on 4/11/61;
FLORENTINO SANTOS, Treasurer,
on 3/14/61;
CARLOS CARBONELL, Secretary,
on 3/2/61

(C)

SOURCES:

PSI [redacted]
Former PSI [redacted]
[redacted]

b6
b7C
b7D

b1

~~ENCLOSURE~~

1-2-1-

DIRECTOR, FBI (100-551)

5/9/61

SAC, TAMPA (97-2)

WJH
ST

JULY 26TH MOVEMENT - TAMPA
IS - CUBA;
RA - CUBA

Re: CRYLOT, dated 4/9/61.

Set forth below is the information regarding the Tampa Office's current live informant coverage of captioned organization. (Discolution of captioned group has been reported previously. Investigation to date fails to reflect that this organization has reactivated in this area.)

1. ESTABLISHED SOURCES AND INFORMANTS Total
= (CUBA) 5

(Decrease is due to deletion of C.S.

[redacted] [redacted]

2. POTENTIAL SOURCES OF INFORMATION Total
5

(On 4/6/61, former Tampa PSI [redacted]

[redacted]

Information re PSI was furnished Miami Office by communication dated 4/12/61)

b6
b7C
b2
b7D

3. MEMBERS OF JULY 26th MOVEMENT INTERVIEWED DURING LAST MONTH. Total
9

2 - Bureau
2 - Tampa
SWJ:cmj
(4)

197-4455
NOT RECORDED
184 MAY 17 1961

56 MAY 18 1961

ORIGINAL COPY FILED IN 100-551-231

TP 97-2

	<u>Total</u>
(a) Cooperative and having potential as source.	2
(b) Having no informant or source potential.	6
(c) Uncooperative	1

For the information of the Bureau the following named individuals, which have informant potential relating to coverage of this matter, have been opened for appropriate background investigation. It is contemplated that Bureau authority will be requested to utilize these individuals, and this matter will be pursued expeditiously.

(a) [redacted]
as a confidential source.

(b) [redacted] as a PSI.

(c) [redacted] as a PSI.

(d) [redacted] as a PSI.

(e) [redacted] as a PSI.

(f) [redacted] as a PSI.

b6
b7C
b2
b7D

No deletion per OGA letter dated 3/1/2010

EXEMPTED FROM AUTOMATIC
DECLASSIFICATION
AUTHORITY DERIVED FROM:
FBI AUTOMATIC DECLASSIFICATION GUIDE
EXEMPTION CODE 25X(1-HUMAN/AAG)
DATE 02-23-2010

UNITED STATES GOVERNMENT
MEMORANDUM

TO: DIRECTOR, FBI (97-4455)

DATE: 7/24/61

FROM: SAC, TAMPA (97-2)

SUBJECT: JULY 26TH REVOLUTIONARY MOVEMENT
IS - CUBA

ALL INFORMATION CONTAINED
HEREIN IS UNCLASSIFIED EXCEPT
WHERE SHOWN OTHERWISE

Transmitted herewith are nine copies of a letter-
head memorandum, together with nine copies of a memorandum
evaluating sources utilized therein, which have been disseminated
to OSI, ONI, CIC, INS, G-2 and Customs locally.

Letterhead is classified as confidential inasmuch
as information from TP T-2 and TP T-3 could reasonably result
in the identification of confidential informants of continuing
value and compromise their future effectiveness.

Careful consideration was given to each source
concealed and T symbols utilized only where the identity of
the informant must be concealed.

INFORMANTS

TP T-1	[redacted]	(UI)	b6
TP T-2	[redacted]	(UI)	b7C
TP T-3	[redacted]		b2
TP T-4	[redacted]	(By request)	b7D

P

- 2 - Bureau (Enc. 18) (RM)
- 4 - Miami (Enc. 8) (RM)
- 10 - Tampa (1 - 97-2) (7/26 RM)
 - (2 - 105-New (FELIX G. VALDES)
 - (2 - 105-New (CARLOS MANUEL BONO)
 - (2 - 105-New (MANUEL ALVAREZ) / 05-102995
 - (1 - 105-179) (CARLOS CABRERA)
 - (1 - 105-546) (G. VALDIVIA)
 - (1 - 105-564) (G. VALDIVIA, JR.)

REC-17

97-4455-15

10 JUL 27 1961

ECP:jn
(16)

APR 18 1966

ENCLOSURE

Copy to: CIA/State/RAB
ONI/OSI/G2/AAC

by routing slip for info.

Date 8-1-61 by [signature]

EX-113

DEC 13 1961

55 AUG 1 1961

UNRECORDED COPY FILED IN 105-105407-105-124165

AND COPY OF ENCL

TP: 97-2.

(C)

The following sources utilized in characterizations:

[redacted]	[redacted]	and	[redacted]	
[redacted]	[redacted]	Former	[redacted]	and [redacted]
[redacted]	[redacted]	and Former	PSI	[redacted]

b2
b7D

b1

LEADS:

MIAMI

AT MIAMI, FLORIDA

Will furnish Tampa with any information identifiable from Miami indices regarding VALDES, BONO and ALVAREZ, and also check files of INS, Miami.

TAMPA

AT TAMPA, FLORIDA

Will attempt to verify departure for Cuba of individuals mentioned in letterhead memorandum.

*Rec'd by
mm lit 9/25/61
under separate caption
(105-102995)*

~~CONFIDENTIAL~~



UNITED STATES DEPARTMENT OF JUSTICE
FEDERAL BUREAU OF INVESTIGATION

In Reply, Please Refer to
File No.

Tampa, Florida
July 24, 1961

541
37
24

JULY 26TH REVOLUTIONARY MOVEMENT
INTERNAL SECURITY - CUBA

On July 20, 1961, TP T-1, a Cuban living in the United States, who has some knowledge of the Cuban population in the Tampa area, advised that during that week he [redacted]

[redacted]
TP T-1 furnished [redacted]

[redacted]
[redacted] wherein it was stated that [redacted]

[redacted]
License numbers furnished by TP T-1 were checked through the Hillsborough County Vehicle Registration Records and found to be listed to the following individuals:

b6
b7C
b7D

[redacted] Tampa, for a 1955 Oldsmobile.

[redacted] Tampa, for a 1955 Chevrolet.

[redacted] Tampa, for a 1956 Chevrolet.

[redacted] Tampa, for a 1955 Plymouth.

FLA
CUBA

[redacted]
TP T-1 stated that [redacted]

which was subsequently determined to be issued to [redacted] Tampa, for a 1957 Chevrolet.

During interview February 15, 1961, [redacted] advised Special Agents of the FBI that he sympathizes with FIDEL CASTRO and the present regime in Cuba because schools are being built to educate the illiterate. On June 28,

FLA

97-2455-15

~~CONFIDENTIAL~~
ENCLOSURE

APR 18 1966

~~CONFIDENTIAL~~

1961, TP T-2 stated that [redacted]
[redacted]

Characterizations of the FPCC and FPCC-TP appear in the appendix hereto.

On March 15, 1961, TP T-3 advised that [redacted] and [redacted]
[redacted]

*FLA
cuBA*

[redacted] On May 16, 1961, TP T-4 [redacted]
[redacted]

[redacted] stated that [redacted]
[redacted]

b6
b7C
b7D

According to TP T-4 [redacted]
[redacted]

On July 24, 1961, TP T-3 advised that [redacted] and [redacted] as well as the [redacted]
[redacted]

~~CONFIDENTIAL~~

~~CONFIDENTIAL~~APPENDIXFAIR PLAY FOR CUBA COMMITTEE (FPCC)

The April 6, 1960 edition of "The New York Times" newspaper contains a full page advertisement captioned, "What is Really Happening in Cuba," placed by the FPCC. This advertisement announced the formation of the FPCC in New York City, listed various sponsors of the Committee and declared the FPCC intended to promulgate "the truth about revolutionary Cuba" to neutralize the distorted American press on Cuban affairs.

"The New York Times" edition of January 11, 1961, reported that at a hearing conducted before the United States Senate Internal Security Subcommittee on January 10, 1961, Dr. CHARLES A. SANTOS-BUCH identified himself as one of the organizers of the FPCC. Also Dr. SANTOS-BUCH identified ROBERT TABER as a co-organizer of the FPCC and said TABER drafted the aforementioned FPCC advertisement. Dr. SANTOS-BUCH further testified that he and TABER obtained \$3,500 from the Cuban Government through the son of Cuba's Foreign Minister, which funds, along with about \$1,100 collected from supporters of the FPCC, paid for the cost of aforementioned advertisement in "The New York Times."

On October 3, 1960, a source advised that the Socialist Workers Party (SWP) in New York had become active in the FPCC, and that SWP members, in a recent FPCC election, had been able to remove several Communist Party members who were on the Executive Board of the FPCC and gain control of organization. This source asserted that the SWP members believed that they had achieved a great influence in the course of the Cuban revolution through their control of the FPCC.

On February 10, 1961, a second source advised that PHIL BART, National Organizational Secretary and member of the National Committee, CP, USA, had reportedly stated recently that the FPCC had been captured by the Trotskyites, but that the CP had not given up in the FPCC.

The SWP and the CP, USA, have been designated by the Attorney General of the United States pursuant to Executive Order 10450.

~~CONFIDENTIAL~~

FAIR PLAY FOR CUBA COMMITTEE -
TAMPA DIVISION
(FPCC-TP)

~~CONFIDENTIAL~~

The Sunday "Tampa Tribune" newspaper for May 15, 1960, carried an advertisement captioned "What is Really Happening in Cuba?" which purported to show the United States press had given a false picture of conditions in Cuba with regard to communism, confiscation of property, and chaotic living conditions. The advertisement was signed "The Fair Play for Cuba Committee, 60 East 42nd Street, New York 17, New York," (FPCC).

On June 24, 1960, [redacted]

[redacted] Tampa, advised he placed the aforementioned advertisement in the "Tampa Tribune," with the assistance of funds contributed by pro-Cuban groups in Tampa. [redacted] said there was no FPCC in Tampa on that date.

On January 9, 1961, a source advised that on January 5, 1961, [redacted]

[redacted] Source advised on February 2, 1961, that [redacted] had said [redacted] and [redacted]

[redacted] This source subsequently advised the Tampa Bay Chapter is affiliated with the national organization known as FPCC, 60 East 42nd Street, New York, [redacted]

[redacted] Source advised that the following have also been active leaders in FPCC-TP activities: [redacted]

Local newspaper articles have indicated and source reported June 2, 1961, the following individuals were elected to the Executive Committee of FPCC-TP at a meeting in Tampa on June 2, 1961, wherein a charter from the national FPCC was presented: [redacted]

[redacted] was identified as a member of the Proletarian Party of America (PPA) in 1958 by a source.

[redacted] was known to a source as a former member of the Communist Party (CP) and the PPA who continued to associate with PPA members in Tampa and to express sympathy for the CP and Soviet Russia.

b6
b7C
b7D

~~CONFIDENTIAL~~

~~CONFIDENTIAL~~

[redacted] was identified in April, 1955, by a source, as a former member of the CP who at that time stated his intention to again become active in the CP as soon as possible.

Regarding [redacted] on September 23, 1943, the records of the Philadelphia Voters Registration Commission, Room 1401, City Hall Annex, Market and Broad Streets, Philadelphia, Pennsylvania, disclosed that [redacted]

b6
b7c

[redacted] as a communist. The records of the Bureau of Police, Philadelphia, reflected on [redacted] was a CP nominating petition signer in 1940.

The CP and PPA have been designated by the Attorney General of the United States pursuant to Executive Order 10450.



UNITED STATES DEPARTMENT OF JUSTICE
FEDERAL BUREAU OF INVESTIGATION

In Reply, Please Refer to
File No.

Tampa, Florida
July 24, 1961

TP 97-2

TITLE	JULY 26TH REVOLUTIONARY MOVEMENT
CHARACTER	INTERNAL SECURITY - CUBA
REFERENCE	Letterhead memorandum dated and captioned as above.

All sources used in referenced communication (with the exception of those listed below) have furnished reliable information in the past.

TP T-1 and TP T-4, with whom insufficient contact has been had to determine their reliability.

This document contains neither recommendations nor conclusions of the FBI. It is the property of the FBI and is loaned to your agency; it and its contents are not to be distributed outside your agency.

ALL INFORMATION CONTAINED
HEREIN IS UNCLASSIFIED
DATE 02-23-2010 BY UC 60322 LP/STP/SZ

XEROX
APR 18 1966

97-4455-15
ENCLOSURE

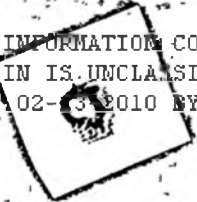

DIRECTOR, FBI (109-551)

7/11/61

SAC, TAMPA (97-2)

JULY 26TH MOVEMENT
IS-CUBA;
RA-CUBA

Remylet, 6/5/61.

Set forth below is the information regarding the Tampa Office's current live informant coverage of captioned organization. (Dissolution of captioned group has been reported previously. Investigation to date fails to reflect renewed activity on part of subject organization.)

1. ESTABLISHED SOURCES AND INFORMANTS (CUBA)

Total
8

(Increase is due to the addition of the following: [redacted])

[redacted]	CS	[redacted]
------------	----	------------

These three sources are in a position to furnish information regarding names of former members and their activities.)

b6
b7C
b2
b7D

2. POTENTIAL SOURCES OF INFORMATION

Total
6

(Increase is due to the addition of the following: PSI [redacted])

[redacted]	PSI	[redacted]
------------	-----	------------

It is noted that former PSI [redacted] is

presently [redacted] and is included in number 1. above.)

P

- 2 - Bureau
- 2 - Tampa
- SWJ:dmp
- (4)

97-4455-1
RECORDED

JUL 14 1961

58 JUL 17 1961

109-551-101
ORIGINAL FILED IN

TP 97-2

	<u>Total</u>
3. MEMBERS OF THE JULY 26TH MOVEMENT INTERVIEWED DURING THE LAST MONTH.	2
(a) Cooperative and having potential as source.	1
(b) Having no informant or source potential.	1
(c) Uncooperative	0.

For the information of the Bureau, during the month of June, a case on [REDACTED] has been opened for appropriate background investigation of this individual as a PSI.

In addition, [REDACTED] BuFile 105-93665, former [REDACTED] is presently listed as a security source.

b6
b7C
b2
b7D



FEDERAL BUREAU OF INVESTIGATION
WASHINGTON, D. C.

To: **FBI, Tampa (105-542)**

Date: **June 22, 1961**

Re: **FRIENDS OF THE CUBAN
REVOLUTION, aka
Amigos de la Revolucion Cubana
IS-CUDA; RA-CUBA**

J. Edgar Hoover
John Edgar Hoover, Director

July 26 Movement - Tampa, Fla

FBI File No. **105-95061**
Lab. No. **D-369099 DJ**

Examination requested by: **Tampa**
Reference: **Letter 6/2/61**
Examination requested: **Document**
Remarks:

ALL INFORMATION CONTAINED
HEREIN IS UNCLASSIFIED
DATE 02-23-2010 BY UC 60322 LP/STP/SZ

97-4455-
NOT RECORDED
189 JUN 30 1961

Enclosures (10) (Q1-Q16, 2 Lab report)
3 - Tampa (105-24, 105-19, 97-41) Enclosures (3) (3 Lab report)

- Tolson _____
- Parsons _____
- Mohr _____
- Belmont _____
- Callahan _____
- Conrad _____
- DeLoach _____
- Evans _____
- Malone _____
- Rosen _____
- Tavel _____
- Trotter _____
- W.C. Sullivan _____
- Tele. Room _____
- Ingram _____
- Gandy _____

GFM: cet (10)

67 JUL 3 - 1961

MAILED
JUN 22 1961

MAIL ROOM TELETYPE UNIT

REPORT
of the



FEDERAL BUREAU OF INVESTIGATION
WASHINGTON, D. C.

To: FBI, Tampa

Date: June 22, 1961
FBI File No. 105-99861
Lab. No. D-369099 DJ

Re: FRIENDS OF THE CUBAN REVOLUTION, aka
Amigos de la Revolucion Cubana
IS-CUBA; RA-CUBA

ALL INFORMATION CONTAINED
HEREIN IS UNCLASSIFIED
DATE 02-23-2010 BY UC 60322 LP/STP/SZ

Specimens received 6/7/61

- Q1 Mimeographed handbill entitled "AL Pueblo de Tampa" dated "ABRIL. 1961."
- Q2 Mimeographed handbill entitled "AL PUEBLO DE TAMPA" dated "ABRIL 24.00 1961"
- Q3 Mimeographed handbill entitled "PROFANACION AL APOSTOL [redacted]"
- Q4 Mimeographed handbill entitled "AL PUEBLO DE TAMPA"
- Q5 Mimeographed handbill entitled "AL PUEBLO DE TAMPA" dated "Mac 1961"
- Qc6 Photocopy of two-page typewritten letter dated 1/3/60, bearing on second page the signature [redacted]
- Qc7 Photocopy of two-page typewritten letter dated 1/27/60, bearing on second page the signature "Mrs. [redacted]"
- Q8 Mimeographed handbill entitled "THE LOCAL PRO-CASTROITES"
- Q9 Envelope bearing typewritten address "Mr. [redacted] Fla." postmarked "TAMPA 4 FLA. APR 4 1961 12 30PM"
- Q10 Accompanying mimeographed handbill entitled "FAIR PLAY FOR CUBA" bearing at top a typewritten note to "Mr. [redacted]" and signed [redacted]

b6
b7c

- Tolson
- Parsons
- Mohr
- Belmont
- Callahan
- Conrad
- DeLoach
- Evans
- Malone
- Rosen
- Tavel
- Trotter
- W.C. Sullivan
- Tele. Room
- Ingram
- Gandy

Page 1

GFM: cet (10)

(continued on next page)

MAIL ROOM TELETYPE UNIT

- Q12 Three-page mimeographed handbill entitled "MOVIMIENTO PATRIOTICO DE TAMPA"
- Q13 Mimeographed handbill entitled "COMPANEROS (A) SUBSCRIPTORES:"
- Q14 Printed handbill entitled "CUBA, SI! siquitrillados, traidores, esbirros, NO!"
- Q15 Mimeographed handbill entitled "Companeros lectores de Revolucion:" dated "Noviembre 11 de 1960"
- Q16 Mimeographed handbill entitled "AL PUEBLO DE TAMPA" addressed to "TRABAJADORES TABAQUEROS DE TAMPA:"

Result of examination:

It was determined that Q1 through Q5, Q8, Q10 through Q13 (with exception of the top portion of Q10), Q15 and Q16 were mimeographed. No significant characteristics are present which would indicate the make of mimeograph machine; hence, it is not possible to state if two or more of these documents were prepared on the same machine.

Q14 was prepared by an offset printing process. No significant characteristics are present which would indicate the make of the printing equipment.

The typewriting on Q9 and the top portion of Q10 match the Laboratory standards for Corona elite style of type spaced twelve letters to the inch. The typewriting on the mimeographed documents and the photocopies is not sufficiently legible or detailed to determine the exact styles of type used, but set forth below are the styles of type which most closely match the questioned typewriting.

Qc7 (except the editor's note at the end)

Remington pica, ten letters to the inch

Qc6

Underwood pica, ten letters to the inch

Q10 (except the top portion)

L C Smith elite, twelve letters to the inch

Q8	Underwood elite, twelve letters to the inch
Q3	Hermes, thirteen letters to the inch
Q16	Olympia, eleven letters to the inch
Q1, Q2, Q4, and Q5	Underwood pica, ten letters to the inch
Q11 through Q15	Royal pica, ten letters to the inch

It was concluded that the stencils used to prepare Q1, Q4, and Q5 were prepared on one typewriter. A definite conclusion was not reached as to whether this typewriter was used to prepare the stencil for Q2, due to the indistinct nature of the reproduction.

It was concluded that the stencils used to prepare Q11, Q13, and Q15 were prepared on one typewriter. Because of the poor reproduction of the mimeographed copy, a definite conclusion was not reached as to whether this typewriter was used to prepare the stencils used to prepare Q12 and Q14.

Q1 through Q16 are returned herewith. Appropriate photographs are retained.

UNITED STATES

Memorandum

TO : DIRECTOR, FBI (97-4455)

DATE: 7/27/61

FROM : SAC, TAMPA (97-2)

ALL INFORMATION CONTAINED
HEREIN IS UNCLASSIFIED
DATE 02-23-2010 BY UC 60322 LP/STP/SZ

SUBJECT: JULY 26th MOVEMENT
IS - CUBA
RA - CUBA

ReBulet to WFO dated 7/18/61.

The July 26th Movement formerly maintained head-
quarters at 2006 Avenida Republica de Cuba (14th Street),
Tampa, Florida. The lease formerly held for use of this
office space expired 1/15/61. The space was vacated prior
to the 15th of January, 1961; to date the space remains
unoccupied.

b6
b7c

FLA [redacted]
Tampa, former [redacted]
Tampa, advised on April 11, 1961, that the group has not
existed in Tampa since the abandonment of its former head-
quarters. [redacted] advised no records of the organization
were preserved. [redacted] is employed as a [redacted]

FLA On 6/21/61. [redacted] ORGANIZATION
Tampa, former [redacted] advised that the
organization is completely defunct, and there has been no
activity by this group since its dissolution in January, 1961.

- P
③ - Bureau (RM)
1 - Tampa
SWJ:bct
(4)

63 AUG 2 1961

EX-107

9 JUL 28 1961

NAT. DEF. SEC.

UNRECORDED COPY FILED IN

109-551-10

C/O to 109-551- (July 26th Movement)



F B I

Date: 7/26/61

Transmit the following in PLAIN TEXT
(Type in plain text or code)

Via AIRTEL AIR MAIL - REGISTERED MAIL
(Priority or Method of Mailing)

TO : DIRECTOR, FBI (97-4455)

FROM: SAC, TAMPA (97-2)

REC-95 [Handwritten initials]

JULY 26TH MOVEMENT
IS - CUBA;
RA - CUBA

ALL INFORMATION CONTAINED
HEREIN IS UNCLASSIFIED
DATE 02-23-2010 BY UC 60322 LP/STP/SZ

On this date [redacted] Electronic Communications, Inc., 1501 - 72nd Street North, St. Petersburg, Fla. [redacted] [redacted], furnished the following information.

b6
b7C
b2
b7D

Subsequent to 3:00 PM this date, nine hand-printed stickers, approximately 1 1/2" by 1/2", bearing printed notation "26th Julio," appeared in cafeteria and hall at their factory. [redacted] subsequently advised that individuals determined to be responsible are [redacted] [redacted], and possibly [redacted] [redacted] all employees of [redacted]

[redacted] They were apparently recruited through newspaper ad. [redacted] stated he is checking with USAF, Atlanta, regarding dismissing these individuals due to their activities which they have explained as a "joke."

Information being furnished to OSI locally and being made available to Bureau in event inquiries received, it being noted that [redacted] stated appearance of stickers caused considerable concern among plant employees due to current Cuban situation.

TP indices negative re all three individuals.

PHILADELPHIA, PA.

- 3 - Bureau (AM-RM)
- 1 - Philadelphia (Info) (AM-RM)
- 2 - Tampa

REC-95 97-4455-117

ECP:afe
(6)

EX-132

JUL 28 1961

S.D.
FLA PA
DISTRIBUTED LITERATURE OF
SUBJECT ORGANIZATION

C.C. Wick
Approved:

50 AUG 3 Special Agent in Charge

Sent

SEC: [Handwritten signature]

F266

~~CONFIDENTIAL~~

FEDERAL BUREAU OF INVESTIGATION

REPORTING OFFICE TAMPA	OFFICE OF ORIGIN TAMPA	DATE JUL 27 1961	INVESTIGATIVE PERIOD 6/21 - 7/19/61
TITLE OF CASE THE JULY 26th MOVEMENT, TAMPA, FLORIDA		REPORT MADE BY SA [redacted]	TYPED BY bet
		CHARACTER OF CASE IS - CUBA RA - CUBA	

b6
b7C

REFERENCE: Report of SA [redacted] Tampa, 6/8/61.

- P -

LEADS

TAMPA DIVISION

AT TAMPA, FLORIDA

(1) Will continue to develop information concerning subject organization through interview of former members of this organization and interviews of persons connected with related matters.

b6
b7C
b7D

INFORMANTS

Sources utilized in the characterization of the July 26th Movement, Tampa, appearing in the appendix of this report are:

PSI [redacted]
Former PSI [redacted]

b1

APPROVED	SPECIAL AGENT IN CHARGE	DO NOT WRITE IN SPACES BELOW	
COPIES MADE:		97-4455-18	REC-11
<ul style="list-style-type: none"> 9 - Bureau (97-4155) (RM) 1 - INS, Miami (RM) 1 - ONI, Charleston, S.C. (RM) 1 - G-2, Ft. McPherson, Ga. (RM) 1 - CIC, Orlando, Fla. (RM) 1 - OSI, Robins AFB, Ga. (RM) 3 - Tampa (97-2) 		JUL 31 1961	EX-103
Dissemination Record of Attached Report		Notations	
Agency	Request Recd.	<p>NAT. SECURITY</p> <p>COVER PAGE</p>	
Date Fwd.	How Fwd.		
By			
Copy to:			
	by routing slip for info.		

66 AUG 3 1961

~~CONFIDENTIAL~~

UNITED STATES DEPARTMENT OF JUSTICE
FEDERAL BUREAU OF INVESTIGATION

Copy to: 1-INS, Miami (RM) 1-CIC, Orlando, Fla. (RM)
1-ONI, Charleston, S.C. (RM) 1-OSI, Robins AFB, Ga. (RM)
1-G-2, Ft. McPherson, Ga. (RM)

Report of: SA [redacted]
Date: JUL 27 1961

Office: TAMPA

Field Office File #: 87-2

Bureau File #: 97-4455

Title: THE JULY 26th MOVEMENT, TAMPA, FLORIDA

ALL INFORMATION CONTAINED
HEREIN IS UNCLASSIFIED
DATE 02-23-2010 BY UC 60322 LP/STP/SZ

Character: INTERNAL SECURITY - CUBA;
REGISTRATION ACT - CUBA

Synopsis: Former President of July 26th Movement in Tampa interviewed on 6/21/61 and advised Movement dissolved in January, 1961, after rupture of diplomatic relations between U.S. and Cuba, and not active since. He said Movement in Tampa never pro-Communist.

- P -

DETAILS

b6
b7c

AT TAMPA, FLORIDA

VICTORIANO MANTEIGA, [redacted] ^{FLA}Tampa, advised on June 21, 1961, during the course of an interview with him, that he has not been active in any pro-FIDEL CASTRO organization since May, 1960, when he [redacted]

[redacted] He acknowledged that some anti-CASTRO people have pretended his resignation was a subterfuge, and that he still exercised control over the July 26th Movement, basing this accusation on the mere fact that some of the officers of the July 26th Movement continued to visit MANTEIGA's office. He said this is not true, that he has not tried to influence the Movement in any way since his resignation, but that his friends are welcome to visit him at any time. He remarked that [redacted]

[redacted] continues to visit his office.

FLA

TP 97-2

MANTEIGA went on to say that the July 26th Movement was dissolved after the rupture of diplomatic relations between the United States and Cuba in January, 1961, and has not been active in anyway since that time.

MANTEIGA advised the July 26th Movement, Tampa, was never pro-Communist.

A characterization of the July 26th Movement, Tampa, is contained in the appendix hereto.



UNITED STATES DEPARTMENT OF JUSTICE
FEDERAL BUREAU OF INVESTIGATION

In Reply, Please Refer to
File No. 97-2

Post Office Box 18185
Tampa 9, Florida
July 27, 1961

Title THE JULY 26th MOVEMENT, TAMPA,
FLORIDA

Character INTERNAL SECURITY - CUBA
REGISTRATION ACT - CUBA

Reference Report of SA [REDACTED]
dated July 27, 1961.

b6
b7c

All sources (except any listed below) used in referenced communication have furnished reliable information in the past.

ALL INFORMATION CONTAINED
HEREIN IS UNCLASSIFIED
DATE 02-23-2010 BY UC 60322 LP/STP/SZ

No deletion per OGA letter dated 3/1/2010

FEDERAL BUREAU OF INVESTIGATION
U. S. DEPARTMENT OF JUSTICE
COMMUNICATIONS SECTION
JUL 31 1961
TELETYPE

- Mr. Tolson _____
- Mr. Callahan _____
- Mr. Conrad _____
- Mr. DeLoach _____
- Mr. Evans _____
- Mr. Malone _____
- Mr. Rosen _____
- Mr. Sullivan _____
- Mr. Tavel _____
- Mr. Trotter _____
- Tele. Room _____
- Mr. Ingram _____
- Miss Gandy _____

URGENT 7-31-61 12-12 PM REW

TO DIRECTOR, FBI /97-4455/ AND SAC, MIAMI /97-139/ AND
SAC, NEW YORK /109-81/ NEW YORK VIA WASHINGTON

FROM SAC, TAMPA 1 PAGE

JULY TWENTY SIXTH MOVEMENT, NYC, IS DASH CUBA, RA DASH CUBA.
 RE TAMPA TEL JULY TWENTY NINE. [] INTERVIEWED THIS DATE
 AND ADVISED THAT HE TOLD EMPLOYEE OF NATIONAL AIRLINES THAT HE
 CONSIDERED THE CONVERSATION HE OVERHEARD TO BE A JOKE. []
 OVERHEARD SAID CONVERSATION AT A BAR IN TAMPA NIGHT OF JULY
 TWENTY EIGHT OR MORNING OF JULY TWENTY NINE. ONLY PORTION OF
 CONVERSATION HE HEARD WAS QUOTE I CAN MAKE A LOT OF MONEY IF I
 TAKE A PLANE ON MONDAY UNQUOTE. [] COULD NOT GIVE ANY
 INFORMATION CONCERNING CONVERSATION PRIOR TO OR SUBSEQUENT TO ABOVE
 STATEMENT. HE BELIEVED INDIVIDUAL TO BE JOKING CONCERNING ABOVE
 STATEMENT ALTHOUGH HE HAS NO BASIS FOR SAME. IDENTITY OF TYPE OR
 OWNERSHIP OF PLANE NOT KNOWN. [] HAS NO DESCRIPTION OF SAID INDI-
 VIDUALS. THESE INDIVIDUALS SPOKE IN GOOD ENGLISH WITH NO ACCENT.
 HE ADVISED THAT THESE INDIVIDUALS DID NOT APPEAR TO BE KNOWN AT THE
 BAR WHERE THE ABOVE CONVERSATION TOOK PLACE. ALL AIRLINES TAMPA
 ADVISED.. ALL AGENCIES ADVISED OF ORIGINAL INFORMATION INFORMED
 OF RESULTS OF INTERVIEW WITH [] NO FURTHER INVESTIGATION BEING
 CONDUCTED TAMPA.

Handwritten initials/signature

Handwritten signature

b6
b7c

Vertical handwritten note

REC-97 97-4455-19

AUG 2 1961

NATIONAL SECURITY

DISSEMINATION TO CIA,
State, OSI, G-2

ONI, DEPT, CMB, FAA

by letterhead memo
RELAYED TO []

END

A IN O PLSE

WA 1-16 PM OK FBI WA J MSL

62 AUG 4 1961

MM OK FBI MM FOR

FBI REC'D - LFT - LBE DMIL

Handwritten signature

~~CONFIDENTIAL~~

OPTIONAL FORM NO. 10

UNITED STATES GOVERNMENT

Memorandum

EXEMPTED FROM AUTOMATIC
DECLASSIFICATION
AUTHORITY DERIVED FROM:
FBI AUTOMATIC DECLASSIFICATION GUIDE
EXEMPTION CODE 25X(1-HUMAN/AAC)
DATE 02-22-2010

TO : DIRECTOR, FBI (97-4455)

DATE: 8/23/61

FROM : SAC, TAMPA (97-2)

ALL INFORMATION CONTAINED
HEREIN IS UNCLASSIFIED EXCEPT
WHERE SHOWN OTHERWISE

SUBJECT: JULY 26th REVOLUTIONARY MOVEMENT
IS - CUBA

Transmitted herewith are nine copies of a letterhead memorandum, together with nine copies of a memorandum evaluating sources, utilized therein, which have been disseminated to OSI, ONI, CIC, INS, G-2, and Customs locally.

INFORMANTS

b2
b7D

The sources utilized in the characterization of the July 26th Revolutionary Movement were [redacted] and Former PSI [redacted]

LEAD

b1

MIAMI DIVISION

AT MIAMI, FLORIDA

Information copies of this communication are being furnished to the Miami Office inasmuch as there is investigation outstanding there.

P

No deletion per OGA letter dated 3/1/2010

- 2 - Bureau (Enc. 4) (RM)
- 2 - Miami (Enc. 4) (RM)
- 3 - Tampa (1 - 97-2)
(1 - 105-701)
(1 - 105-702)

SWJ:bct
(7)

Copy to: CIA/State/~~OSI~~
ONI/OSI/G2

XEROX by routing slip for info.
Date 8/30/61 by ERH/ST

APR 18 1966

REC-44

97-4455-20

AUG 28 1961

EX 104

AUG 30

5 52

NATIONAL SECURITY

56 AUG 31 1961

~~CONFIDENTIAL~~

105-12574-20
105-124165
UNRECORDED COPY OF ENCL FILED IN

pc
10/1
f
(C)



UNITED STATES DEPARTMENT OF JUSTICE
FEDERAL BUREAU OF INVESTIGATION

In Reply, Please Refer to
File No.

ALL INFORMATION CONTAINED
HEREIN IS UNCLASSIFIED
DATE 02-23-2010 BY UC 60322 LP/STP/SZ

Post Office Box 18185
Tampa 9, Florida
August 23, 1961

JULY 26TH REVOLUTIONARY MOVEMENT

The following information concerning the named individuals was developed during the course of an investigation by the Tampa Federal Bureau of Investigation Office:

[Redacted]

Cuba On July 25, 1961, [Redacted] *TAMPA, FLA.* United States Customs, Tampa, advised that according to his records of Shippers' Export Declarations for shipments made on the Honduran vessel, the "M. V. Privateer", which departed from Tampa on July 15, 1961, for Cuba, subject's name appears as having shipped to himself as consignee one 1956 Chevrolet automobile.

FLA. On August 7, 1961, [Redacted] Tampa, advised she is a [Redacted]

[Redacted] Subject lived with the [Redacted] prior to their all going to Cuba about three weeks ago. They made the trip to Cuba in order to see [Redacted]

b6
b7c

FLA. [Redacted] said that in contrast to the antipathy [Redacted] feels against FIDEL CASTRO, subject sympathizes with him and his regime. She said subject has never been active in any pro-CASTRO organization to the best of her knowledge.

The records of the Drivers License Bureau, Hillsborough County Courthouse, reflected on August 8, 1961, that subject resided at [Redacted] was born on [Redacted]

[Redacted] advised that subject was born in Cuba.

ENCLOSURE
ENCLOSURE

97-4455-20

TP 97-2

[REDACTED]
[REDACTED] also known as [REDACTED]

On July 25, 1961, [REDACTED] United States Customs, Tampa, advised that according to his records of Shippers' Export Declarations for shipments made on the Honduran vessel, the "M. V. Privateer", which departed from Tampa on July 15, 1961, for Cuba, subject's name appears as having shipped to himself as consignee one 1955 Oldsmobile automobile.

On August 7, 1961, [REDACTED] said that subject previously resided at [REDACTED] Tampa, having come to Tampa four years ago, and that he lived at that address until the fall of 1960. [REDACTED] APPROX

[REDACTED] Their names are [REDACTED]

[REDACTED] Subject was employed by the [REDACTED] in Tampa.

B. APPROX [REDACTED]

In the fall of 1960, the [REDACTED] family moved to [REDACTED] Tampa. Since that time, [REDACTED]

[REDACTED] has been known to be against FIDEL CASTRO during the past. Because of this antipathy, when he tried to obtain permission to go to Cuba lately to [REDACTED] he had difficulty in securing it. Subject received permission to go to Cuba, but prior to leaving the United States, he received word from his family in Cuba that he should not go there because his reputation of having opposed CASTRO would get him into trouble with CASTRO's government. Subject went anyway because he [REDACTED]

On August 7, 1961, [REDACTED] advised that she is a [REDACTED] She said he lived at this address from the fall of 1960 until he left for Cuba about three weeks ago. [REDACTED]

TP 97-2

b6
b7C

[redacted] said that subject has always been opposed to CASTRO and was very apprehensive about going to Cuba for fear he would be persecuted because of his feelings. She said he went to Miami, and left from there for Cuba.

This document contains neither recommendations nor conclusions of the FBI. It is the property of the FBI and is loaned to your agency; it and its contents are not to be distributed outside your agency.



UNITED STATES DEPARTMENT OF JUSTICE
FEDERAL BUREAU OF INVESTIGATION

In Reply, Please Refer to
File No.

Tampa 9, Florida
August 23, 1961

Title JULY 26TH REVOLUTIONARY MOVEMENT

Character INTERNAL SECURITY - CUBA

Reference Letterhead memorandum dated as
 above.

All sources (except any listed below) used in
referenced communication have furnished reliable information
in the past.

ALL INFORMATION CONTAINED
HEREIN IS UNCLASSIFIED
DATE 02-23-2010 BY UC 60322 LP/STP/SZ

ENCLOSURE

97-4455-20

P. O. BOX 102
HAMILTON GRANGER STATION
NEW YORK 21, N. Y.

MOVIMIENTO 26 DE JULIO

PATRIA O MUERTE
VENOEREMOS

DIRECCION CENTRAL EN NORTE AMERICA
600 WEST 129TH STREET
NEW YORK 21, N. Y.

TELEFONO AUDUBON 1-7620

New York Agosto 6-61.

b6
b7c

ALL INFORMATION CONTAINED
HEREIN IS UNCLASSIFIED
DATE 02-23-2010 BY UC 60322 LP/STP/SZ

Sr. Miami, Fla.

Estimado Compañero:

La dirección del M-26-7. en Cuba, nos indica a nosotros aquí en New York cuales son las disposiciones y acuerdos que se deben cumplir o tareas a realizar.

Segun las instrucciones que tenemos hasta el momento, El 26 de Julio es una organización Revolucionaria que lucha pacíficamente por hacer llegar la verdad de nuestra revolución al Pueblo Americano, y en esta forma de principios esta inscrita en Washington; como que defendemos los postulados de un Gobierno Extranjero, para ellos los Norteamericanos y sus leyes somos Agentes extranjeros, por lo cual cada uno de nosotros los Maximos responsables tenemos que estar inscritos en Washington como tales.

Todos nuestros actos y tareas a realizar deben ser siempre en Nombre de el Movimiento, pues bajo otro nombre por no estar registrado, podian entrar en violaciones de las Leyes Norteamericanas, nosotros podemos hacer toda clase de propaganda escrita Radial o en Peliculas, así como piquetes o actos siempre que sean de matiz revolucionario donde los Militantes adquieren conocimientos y adoctrinamiento Político Revolucionario, los ponemos esto en conocimiento para que todos sepan a plenitud cuales son nuestros deberes.

Todas estas actividades no se pueden desarrollar, en otra clase de Organizaciones como son Club sociales y de recreo pues este tipo de organizaciones tienen que inscribirse como de recreo social, y no pueden hacer ninguna clase de propaganda en favor de la Revolución.

Para el día 15 del corriente mes todos los compañeros responsables de las Delegaciones en todos los USA, tienen que hacer su presentación en Washington de sus planillas de inscripción como Agentes Extranjeros.

Todos los compañeros que han sido designados para los cargos tienen que estar conscientes de los deberes contraídos, y si no pueden por cualquier causa aceptar esta responsabilidad, deben de comunicarlo inmediatamente, con el fin de nombrar otro en su lugar.

Fraternamente.

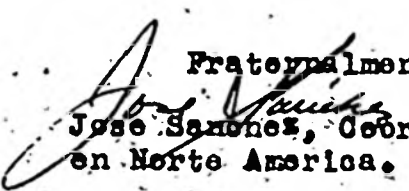
Jose Sanchez, Coordinador General
en Norte America.



ATTENTION

These are the rubber stamps which should be ordered for the use of the Organization, so that all the Organizations of the Movement may have the same kind. Naturally, when they are being made, the city in which the organization is located will be placed on it.

(It will be noted that appearing below the above wording was the inked impression approximately 1½" in diameter left by a rubber stamp; however the wording on the stamp could not be deciphered. Apparently this is the stamp referred to above.)

By the 15th of this month, all the officers of the delegations throughout the United States have to present in Washington their forms registering them as foreign agents.

All the comrades who have been designated for the various positions must be aware of the obligations they have assumed, and if they cannot for any reason accept this responsibility, they must so inform immediately, so that another can be appointed in that position.

Fraternally yours,
JOSE SANCHEZ, Coordinator General
in North America

FAITHFUL TO FIDEL * FAITHFUL TO CUBA * FAITHFUL TO THE
REVOLUTION

(Letterhead of 26 of July Movement,
New York, N.Y.)

New York, August 6, 1961

Mr. [REDACTED]
Miami, Florida

b6
b7c

Dear Comrade:

The administration of the 26 of July Movement in Cuba indicates to us here in New York what measures should be taken, what agreements should be reached and what tasks are to be done.

According to the instructions which we have up to the present time, the 26 of July is a revolutionary organization which is striving peacefully to bring the truth of our revolution to the American people and it is registered in Washington under this form of principles. Since we defend the postulates of a foreign government, in the eyes of the United States and its laws, we are foreign agents; wherefore, every one of us who is an officer (literally, "mostly responsible") has to be registered in Washington as such.

Every meeting to be held and every task to be done should always be in the name of the Movement, since under any other name it could be a violation of the United States laws, because it has not been registered. We can make all types of propaganda, in writing, on the radio and on films; we can picket or hold meetings, provided they are of a revolutionary nature, in which the members acquire knowledge and revolutionary political indoctrination. We give you this information so that all may know fully what our duties are.

All these activities cannot be carried on in any other type of organization, like social or recreation clubs, since this type of organization has to be registered as a social or recreational one and cannot engaged in any type of propaganda in favor of the Revolution.

MM 97-268

[redacted] who is the
[redacted] of the July 26 Club of Miami, Florida. The residence at the above address is vacant at this time. Also enclosed with the letter was a one page note in reference to the stamp of the July 26 Movement.

Enclosed for the Bureau is (1) a photostat of the above letter to Mr. [redacted] (2) a photostat of the note referring to the stamp of the Movement (it is noted the stamp itself is illegible); (3) a translation of the letter to [redacted] (4) a translation of the note referring to the stamp of the 26th of July Movement.

Information copies are being furnished to Baltimore, Boston, Buffalo, Chicago, Los Angeles, Newark, New Haven, New Orleans, New York and Philadelphia, with translations of the letter and note referring to the stamp, for possible future investigative use.

Enclosed for Washington Field are translation copies of the letter to [redacted] and of the note referring to the stamp of the 26 of July Movement. The Washington Field Office will contact the Foreign Agents Registration Section, Internal Security Division of the Department of Justice, and set out appropriate leads to interested offices re the registration of delegates of the July 26 Movement with that Department, who, according to the enclosures, must register as Foreign Agents by August 15, 1961.

b6
b7c

FBI

Date: AUG 14 1961

Transmit the following in _____
(Type in plain text or code)

Via AIRTEL _____
(Priority or Method of Mailing)

TO: Director, FBI (105-82024)(105-97780)

FROM: SAC, Miami (97-268)

JULY 26 CLUB OF MIAMI
MIAMI, FLORIDA
IS - CUBA
RA - CUBA

On 8/10/61 a note was received at the Miami Office from an unknown source, Miami, Florida, enclosing a photostat of a letter dated 8/6/61 to [redacted] from [redacted]. Instant note advised this letter was sent to [redacted], Miami, Florida and was postmarked 2 AM, 8/7/61 at New York, N.Y. with the return address of [redacted] N.Y. The address [redacted] Miami, Florida is a residence belonging to

b6
b7c

- R
- ③ - Bureau (8 Encls.)(AM)
 - 1 - Baltimore (Info.)(2 Encls.)
 - 1 - Boston (Info.)(2 Encls.)
 - 1 - Buffalo (Info.)(2 Encls.)
 - 1 - Chicago (Info.)(2 Encls.)
 - 1 - Los Angeles (Info.)(2 Encls.)
 - 1 - Newark (Info.)(2 Encls.)
 - 1 - New Haven (Info.)(2 Encls.)
 - 1 - New Orleans (Info.)(2 Encls.)
 - 2 - New York (Info.)(4 Encls.)(AM)
(109-81)(105-47474)
 - 1 - Philadelphia (Info.)(2 Encls.)
 - 2 - Washington Field (2 Encls.)(AM)
 - 2 - Miami (97-268)(1 cc: 105-3484 with 2 Encls.)

JMS:JMS
(18)

Approved: [Signature] Sent _____ M Per _____
Special Agent in Charge

ATENCIÓN

Estos son los cuños que tienen que mandar a hacer para uso de la Organización, para que así todas las Organizaciones del Movimiento sean iguales. Naturalmente que al hacerlos les pondrán la ciudad donde reside la Organización.



MOVIMIENTO
26
JULIO ✕
NEW YORK, N.Y.

ALL INFORMATION CONTAINED
HEREIN IS UNCLASSIFIED
DATE 02-23-2010 BY UC 60322 LP/STP/SZ

DIRECTOR, FBI (109-551)

8/9/61

SAC, TAMPA (97-2)

JULY 26TH MOVEMENT
IS - CUBA;
RA - CUBA

ALL INFORMATION CONTAINED
HEREIN IS UNCLASSIFIED
DATE 02-23-2010 BY UC 60322 LP/STP/SZ

Remylot, 7/11/61.

Set forth below is the information regarding the Tampa Office's current live informant coverage of captioned organization. (Investigation to date fails to reflect evidence of reactivation on part of subject organization, which disbanded in January, 1961, as previously reported.)

- | | |
|---|--------------|
| 1. ESTABLISHED SOURCES AND INFORMANTS (CUBA) | <u>TOTAL</u> |
| (Increase is due to the addition of [redacted] who is in a position to furnish information regarding names of former members and their activities.) | 9 |
| 2. POTENTIAL SOURCES OF INFORMATION | 5 |
| (It is noted that former PSI [redacted] is presently [redacted] and is included in Number 1 above, thereby causing a decrease of one in this category.) | |
| 3. MEMBERS OF THE JULY 26TH MOVEMENT INTERVIEWED DURING THE LAST MONTH | 3 |
| (a) Cooperative and having potential as source. | 0 |
| (b) Having no informant or source potential. | 3 |
| (c) Uncooperative | 0 |

my

109-551-601

2 - Bureau (RM)
1 - Tampa
SWJ:jn
(3)

97-4655-
NOT RECORDED
87 AUG 16 1961

F 77

52 AUG 1 1961

~~CONFIDENTIAL~~

No deletion per OGA letter dated 3/1/2010

FEDERAL BUREAU OF INVESTIGATION

REPORTING OFFICE TAMPA	OFFICE OF ORIGIN TAMPA	DATE SEP 25 1961	INVESTIGATIVE PERIOD 8/1/61 - 9/7/61
TITLE OF CASE THE JULY 26th MOVEMENT, TAMPA, FLORIDA		REPORT MADE BY SA [redacted]	TYPED BY ih
		CHARACTER OF CASE IS - CUBA RA - CUBA	

ALL INFORMATION CONTAINED
HEREIN IS UNCLASSIFIED EXCEPT
WHERE SHOWN OTHERWISE

REFERENCE:

Report of SA [redacted] Tampa, 7/27/61.

- P -

EXEMPTED FROM AUTOMATIC
DECLASSIFICATION

LEADS

AUTHORITY DERIVED FROM:
FBI AUTOMATIC DECLASSIFICATION GUIDE
EXEMPTION CODE 25X(1-HUMAN/AAG)
DATE 02-22-2010

b6
b7C

TAMPA DIVISION

AT TAMPA, FLORIDA

(1) Will continue to develop information concerning subject organization through interview of former members of this organization and interviews of persons connected with related matter.

(2) Will interview [redacted] Tampa for whatever information he might furnish concerning

APPROVED	SPECIAL AGENT IN CHARGE	DO NOT WRITE IN SPACES BELOW	
COPIES MADE:		97-4455-21	REC-40
(9) - Bureau (97-4455) (RM)			
1 - INS, Miami (RM)			
1 - ONI, Charleston, S. C. (RM)			
1 - G-2, Ft. McPherson, Ga. (RM)			
1 - CIC, Orlando, Fla. (RM)		22-SEP-26 1961	
1 - OSI, Robins AFB, Ga. (RM)			
2 - Tampa (97-2)			

Dissemination Record of Attached Report

Agency	Request Recd.	Date Fwd.	How Fwd.	By
			Copy to: CIA/State/RAB	
			ONI/OSI/G2/Spec	
			by routing slip for info.	
		Date 9-29-61	by [signature]	

Notations

64 OCT 2 1961

~~CONFIDENTIAL~~

TP 97-2

[redacted] to possibly aid subject organization in future. If outcome of interview with [redacted] is positive, will attempt to identify individuals mentioned as participants in [redacted] and conduct appropriate investigation to determine their activities.

ADMINISTRATIVE:

This communication is classified "~~Confidential~~" inasmuch as it contains information from TP T-1, an informant of lasting value, which if disclosed would impair his future worth.

INFORMANTS

IDENTITY

LOCATION OF ORIGINAL INFORMATION

TP T-1 is [redacted]

[redacted]

Sources utilized in the characterization of the JULY 26th MOVEMENT contained in the appendix hereto are:

b6
b7C
b2
b7D

(C)

[redacted]
Former PSI [redacted]

b1

Tampa sources and informants contacted with negative results re subject organization were:

8/14/61 PSI [redacted] by SA [redacted]

8/31/61 PSI [redacted] by SA [redacted]

9/5/61 [redacted] by SA [redacted]

Careful consideration was given to the use of T symbols and were used only where the identity of informants need be concealed.

~~CONFIDENTIAL~~

UNITED STATES DEPARTMENT OF JUSTICE
FEDERAL BUREAU OF INVESTIGATION

DECLASSIFICATION AUTHORITY DERIVED FROM:
FBI AUTOMATIC DECLASSIFICATION GUIDE
DATE 02-23-2010

Copy to: 1 - INS, Miami (RM)
1 - ONI, Charleston, S. C. (RM)
1 - G-2, Ft. McPherson, Ga. (RM)
1 - CIC, Orlando, Fla. (RM)
1 - OSI, Robins AFB, Ga. (RM)

Report of: SA [REDACTED]

Office: TAMPA

Date: SEP 25 1961

Field Office File #: TP 97-2

Bureau File #: 97-4455

Title: THE JULY 26th MOVEMENT,
TAMPA, FLORIDA

Character: INTERNAL SECURITY - CUBA
REGISTRATION ACT - CUBA

Synopsis: [REDACTED] of July 26th Movement, Tampa, interviewed on 8/28/61, and he advised that organization has held no meetings since its dissolution in January, 1961. nor has it had any activity since that time. [REDACTED] a former member, advised on 8/7/61, that there has been no activity of subject organization since it was dissolved in January, 1961. Tampa sources and informants report no present activity of subject organization.

of subject organization
- P -

b6
b7c

DETAILS:

AT TAMPA, FLORIDA

PRESENT STATUS OF JULY 26th MOVEMENT
IN TAMPA

On August 7, 1961, [REDACTED] Tampa, Fla. a former member of the July 26th Movement, Tampa, advised on August 7, 1961, that there has been no activity of the organization since dissolution in January, 1961. He said he knew of no movement to reactivate the group.

A characterization of the July 26th Movement is contained in the appendix hereto.

~~CONFIDENTIAL~~

TP 97-2

[redacted] Tampa, advised August 28, 1961, that he is the [redacted] who was a [redacted] of the July 26th Movement in Tampa. He said that he was never a member of the group, however, due to [redacted] he had knowledge of the activities of the July 26th Movement. He said that since the dissolution of the group in January, 1961, there have been no meetings nor activities of the organization in the Tampa area to the best of his knowledge.

b6
b7C

RUMORED MILITARY TRAINING FOR
POSSIBLE FUTURE AID OF JULY 26th
MOVEMENT IN TAMPA

On August 1, 1961, TP T-1 advised that he had received word from [redacted] Tampa, that it is rumored that the below named men are doing some [redacted] [redacted] The rumored purpose of their activity is that some day in the future they may be called to aid in some way the subject organization. [redacted] works at an [redacted] Tampa. TP T-1 named the men as follows:

[redacted] Tampa F12

F12 [redacted] APPROX [redacted] No other data.

b6
b7C
b7D

[redacted] Tampa F12 no other data.

[redacted] aka [redacted]

[redacted] no other data. Tampa F12 B. APPROX. [redacted]

[redacted] no other data. B. APPROX. [redacted] F12

F12 Informant said it was further rumored that [redacted] He was a [redacted] in the Revolutionary Army of Cuba, and is a [redacted] He at present claims to be a [redacted] Informant

TP 97-2

could offer no proof or evidence of these training activities, nor could he tell when or where they were allegedly taking place.

Other Tampa sources and informants were contacted during August and September with negative results.



UNITED STATES DEPARTMENT OF JUSTICE
FEDERAL BUREAU OF INVESTIGATION

In Reply, Please Refer to
File No.

Tampa, Florida

SEP 25 1961

ALL INFORMATION CONTAINED
HEREIN IS UNCLASSIFIED
DATE 02-23-2010 BY UC 60322 LP/STP/SZ

Title	THE JULY 26th MOVEMENT, TAMPA, FLORIDA
Character	INTERNAL SECURITY - CUBA REGISTRATION ACT - CUBA
Reference	Report of SA [redacted] dated and captioned as above

b6
b7c

All sources (except any listed below) used in
referenced communication have furnished reliable information
in the past.

This document contains neither recommendations nor
conclusions of the FBI. It is the property of the FBI and is
loaned to your agency; it and its contents are not to be dis-
tributed outside your agency.

Federal Bureau of Investigation
Records Branch

b6
b7c

_____, 19____

Name Searching Unit - Room 6527

Service Unit - Room 6524

Forward to File Review

Attention _____

Return to 615 R.B.
Supervisor Room Ext.

Type of References Requested:

Regular Request (Analytical Search)

All References (Subversive & Nonsubversive)

Subversive References Only

Nonsubversive References Only

Main _____ References Only

Type of Search Requested:

Restricted to Locality of _____

Exact Name Only (On the Nose)

Buildup Variations

Subject

Birthda

Address _____

Localities _____

R# _____ Date 9/29 Searched AKK
Initials

Prod. _____

FILE NUMBER SERIAL

NR
names + address
NR

ALL INFORMATION CONTAINED
HEREIN IS UNCLASSIFIED
DATE 02-23-2010 BY UC 60322 LP/STP/SZ

File #6 - EPA



DIRECTOR, FBI (109-551)

9/7/61

SAC, TAMPA (97-2)

JULY 26TH MOVEMENT
IS - CUBA
RA - CUBA

Remylet 8/9/61.

Set forth below is the information regarding the Tampa Office's current live informant coverage of captioned organization. (Investigation to date fails to reflect evidence of reactivation on part of subject organization, which became defunct in January, 1961, as has been reported.)

	<u>Total</u>
1. ESTABLISHED SOURCES AND INFORMANTS (CUBA)	9
2. POTENTIAL SOURCES OF INFORMATION	9
(Increase is due to addition of PSI [redacted])	
[redacted] PSI [redacted]	
[redacted] PSI [redacted]	
[redacted] and PSI [redacted]	
all of whom are in a position to furnish information regarding names of former members and their activities.)	
3. MEMBERS OF THE JULY 26TH MOVEMENT INTERVIEWED DURING THE LAST MONTH	4
(a) Cooperative and having potential as source.	1
(b) Having no informant or source potential	3
(c) Uncooperative	0

b6
b7C
b2
b7D

ORIGINAL FILED IN

For the information of the Bureau, a new [redacted] has been opened on [redacted] former member, for appropriate investigation.

2 - Bureau (RM)
1 - Tampa
SJW:cwp
(3)

97-4455-

NOT RECORDED
191 SEP 13 1961

50 SEP 13 1961

UNITED STATES

Memorandum

TO : DIRECTOR, FBI (97-4455)

DATE: 10-6-61

FROM : SAC, Tampa (97-2)

SUBJECT: JULY 26TH MOVEMENT
IS - CUBA
RA - CUBA

ALL INFORMATION CONTAINED
HEREIN IS UNCLASSIFIED
DATE 02-23-2010 BY UC 60322 LP/STP/SZ

Remylet dated 9/7/61.

The following is the Tampa Office's current live informant coverage on captioned group. (Investigation to date has failed to show that this organization has reactivated in this area.) However, on 8-2-61, CARLOS CARBONELL VALDEZ, IS-CUBA, RA - CUBA (Bufile 105-93249) (TP 105-89), registered with the U. S. Department of Justice and described his activities as follows: "To direct, coordinate the activities of the 26th of July Movement in the area of Tampa, Florida."

1. ESTABLISHED SOURCES AND INFORMANTS (CUBA)	TOTAL 5
--	------------

2. POTENTIAL SOURCES OF INFORMATION	14
-------------------------------------	----

This is an increase of two with the addition of [redacted] 97-4480 and [redacted]

b6
b7C
b2
b7D

3. MEMBERS OF THE JULY 26TH MOVEMENT INTERVIEWED DURING LAST MONTH.	6
---	---

- (a) Cooperative and having potential as source 0
- (b) Having no informant or source potential 5
- (c) Uncooperative 1

P

2 - Bureau
2 - Tampa

FAS/onl
(4)

EX-116

REC-123

97-4455-22

OCT 13 3 33 PM '61 OCT 9 1961

REC.

63 OCT 16 1961

UNRECORDED COPY FILED IN 107-551-

C/c 109-551 (July 26th Movement)

TP 97-2

1. [redacted] Bufile 105-99660, TP 105-415,
on 9-11-61 (c).
2. [redacted] Bufile 105-97598, TP 105-339
on 9-12-61 (b).
3. [redacted] Bufile 105-94127, TP 105-298,
on 9-22-61 (b).
4. [redacted] Bufile 105-101806, TP 105-344,
on 9-29-61 (b).
5. [redacted] on 9-28-61 (b).
6. [redacted] on
9-28-61 (b).

b6
b7C
b2
b7D

1 - Mahoe
1 - Larrell

SAC, Tampa (97-2)

11-22-61

Director, FBI (97-4455) - 23

JULY 26TH MOVEMENT, TAMPA, FLORIDA
IS - CUBA
REGISTRATION ACT - CUBA

Rerep of SA Frederick A. Slight dated 11-16-61.

Dissemination of report at Bureau being held in
abeyance pending clarification of the following:

Characterization appearing on page two dealing
with Monroe Defense Committee poorly worded and creates
impression Bureau's charge of kidnaping against [redacted]
[redacted] was "trumped up."

Furnish source of your characterization of 27767
Monroe Defense Committee. If characterization as set
forth is inaccurate and requires revision, submit revised
page two.

ERH:ekg
(5)

b6
b7c

NOTE:

Thumbnail sketch of Monroe Defense Committee
incorporated in referenced report indicates kidnaping charge
lodged against [redacted] and his friends was a "trumped up"
charge. This is inaccurate as [redacted] is now a Bureau
fugitive currently residing in Cuba. Clarification of the
characterization is necessary.

MAILED 19
NOV 21 1961
COMM-FBI

SAD

ERH

MAIL ROOM TELETYPE UNIT

FEDERAL BUREAU OF INVESTIGATION

REPORTING OFFICE TAMPA	OFFICE OF ORIGIN TAMPA	DATE NOV 16 1961	INVESTIGATIVE PERIOD 9/11 - 11/2/61
TITLE OF CASE JULY 26TH MOVEMENT, TAMPA, FLORIDA		REPORT MADE BY SA FREDERICK A. SLIGHT	TYPED BY dmp
EXEMPTED FROM AUTOMATIC DECLASSIFICATION AUTHORITY DERIVED FROM: FBI AUTOMATIC RECLASSIFICATION GUIDE EXEMPTION CODE 25X(1-HUMAN/AAG) DATE 02-23-2010		CHARACTER OF CASE IS-CUBA; RA-CUBA	

REFERENCE:

Report of SA [redacted] 9/25/61, at Tampa;
 Bureau letters 10/16, 19, 20 and 24/61;
 Tampa teletypes to Bureau 10/25 and 26/61;
 Tampa letter to Bureau 10/30/61.

b6
b7c

- P -

LEADS:

TAMPA

ALL INFORMATION CONTAINED
HEREIN IS UNCLASSIFIED EXCEPT
WHERE SHOWN OTHERWISE

*Do not destroy any copies
Dissemination to be
cancelled 17P.
C*

AT TAMPA, FLA.

1. Will attempt to verify reported firearms practice about one mile south of Highway 60 off of Highway 301 in an area reached by turning off 301 to the right on a road by the railroad tracks.
2. Continue to report activities of captioned organization.

EXT. PROC.

APPROVED <i>[Signature]</i>	SPECIAL AGENT IN CHARGE	DO NOT WRITE IN SPACES BELOW	
COPIES MADE: 9 - Bureau (97-4455) (RM) 1 - INS, Miami (RM) 1 - ONI, Charleston, S.C. (RM) 1 - G-2, Ft. McPherson, Ga. (RM) 1 - INTC, Orlando, Fla. (RM) 1 - OSI, Robins AFB, Ga. (RM) 3 - Tampa (1 - 105-89) (2 - 97-2)		97-4455-23 20 NOV 20 1961	
Dissemination Record of Attached Report		Notations	
Copy to: CIA/State/RAR		<i>[Handwritten notes]</i> NAT. INT. SEC.	
Date Recd.:	OSI/OSI/G2/7AC/31		
By routing slip for info.			
Date 12/6/61 by [Signature]			

*Get SAC Tampa
CRH:alg 11-22-61
CONFIDENTIAL*

TP 97-2

INFORMANTS:

<u>IDENTITY</u>	<u>LOCATION OF ORIGINAL INFORMATION</u>
TP T-1 is [redacted]	[redacted]
TP T-2 is PSI [redacted] [redacted]	[redacted]
TP T-3 is [redacted]	Anonymous
TP T-4 is [redacted]	[redacted]
TP T-5 is PSI [redacted]	[redacted]

b6
b7C
b2
b7D

Sources contacted during September and October, 1961, which are mentioned in the body of this report as being unable to furnish information concerning captioned organization are identified as follows:

[redacted] contacted 10/3/61, by SA [redacted]
 PSI [redacted] contacted 10/4/61, by SA [redacted]
 PSI [redacted] contacted 10/9/61, by SA [redacted]
 [redacted]
 PSI [redacted] contacted 9/27/61, by SA [redacted]
 [redacted] contacted 9/25/61, by SA [redacted]
 CS [redacted] contacted 9/14/61, by SA [redacted]
 PSI [redacted] contacted 10/5/61, by SA [redacted]
 CS [redacted] contacted 10/19/61, by SA [redacted]
 PSI [redacted] contacted 9/29/61, by SA [redacted]
 [redacted]

b6
b7C
b2
b7D

Sources utilized in the characterization of July 26th Movement are:

(C) [redacted]
 Former PSI [redacted]
 [redacted]

b1

Sources utilized in the characterization of FPCC are:

[redacted]
 [redacted]

B
COVER PAGE

D

O

TP 97-2

Sources utilized in the characterization of FPCC-TP are:

[redacted]
Former [redacted]
[redacted];
Former [redacted]

b6
b7C
b2
b7D

Careful consideration has been given to sources concealed in this report and T symbols have been utilized only in those instances where identity must be concealed.

This report is being classified ~~confidential~~ as unauthorized disclosure of information contained herein from TP T-1 through T-5 could possibly result in their identification, thereby impairing their future effectiveness.

C*
COVER PAGE

CONFIDENTIAL

UNITED STATES DEPARTMENT OF JUSTICE
FEDERAL BUREAU OF INVESTIGATION

- 1 - INS, Miami (RM)
- 1 - ONI, Charleston, S.C. (RM)
- 1 - G-2, Ft. McPherson, Ga. (RM)
- 1 - INTC, Orlando, Fla. (RM)
- 1 - OSI, Robins AFB, Ga. (RM)

DECLASSIFICATION AUTHORITY DERIVED FROM:
FBI AUTOMATIC DECLASSIFICATION GUIDE
DATE 02-23-2010

Copy to:

Report of: SA FREDERICK A. SLIGHT
Date: NOV 16 1961

Office: Tampa

Field Office File #: 97-2

Bureau File #: 97-4455

Title: JULY 26TH MOVEMENT
TAMPA, FLORIDA

Character: INTERNAL SECURITY-CUBA;
REGISTRATION ACT - CUBA

Synopsis: Sources familiar with activities of July 26th Movement in Tampa report no activity of this organization. CARLOS CARBONELL registered as Coordinator of the July 26th Movement in Tampa with the U. S. Department of Justice on 8/21/61. Alleged firearms training by July 26th in Tampa not verified to date.

- P -

b6
b7C
b7D

DETAILS:

PRESENT STATUS AND REPORTED MEMBERS OF
JULY 26TH MOVEMENT, TAMPA

FLA
TP T-1 advised on September 11, 1961, that he believes that [redacted] was formerly some sort of officer in the July 26th Revolutionary Movement. [redacted]

[redacted] Source knew nothing further concerning these meetings.

A characterization of the July 26th Movement is contained in the appendix hereto.

TP T-2 advised on September 13, 1961, that he had heard from an unrecalled source that the 26th of July Club is holding meetings in a frame house across the street from the Gradias-Annis Cigar Factory on 14th Street in Tampa. This house is across the street from the main entrance to Gradias-Annis.

CONFIDENTIAL

TP 97-2

TP T-3 advised on September 29, 1961, that [redacted] [redacted] of the July 26th Movement in New York, was in contact with an unknown individual in [redacted]

[redacted]

TP T-4 advised on October 3, 1961, that [redacted] [redacted] of the Fair Play For Cuba Committee (FPCC) was overheard to comment that he had [redacted]

[redacted]

The Monroe Defense Committee has headquarters at 53 W. 125 Street, New York City, and was founded, according to its press releases, to tell the story of Monroe, North Carolina, to the world, to raise funds for the legal defense of individuals currently under arrest in Monroe, N. C., and to provide financial assistance to members of Afro-American community in Monroe, N. C.

b6
b7C
b7D

Characterizations of the FPCC and the Tampa Chapter of the FPCC (FPCC-TP) are contained in the appendix hereto.

TP T-4 further advised on October 3, 1961, that [redacted] [redacted] had stated that CARLOS CARBONELL, who is head of the July 26th Movement in Tampa, is old, going blind and in poor health. He said CARBONELL should be sent back to Cuba if possible.

TP T-1 advised on October 6, 1961, that it appeared that the FPCC and the 26th of July Movement have joined in their efforts on behalf of the CASTRO government. He said that meetings are held at 2513 13th Street every Thursday night, which are attended by CARLOS CARBONELL, [redacted] and other individuals known

TP 97-2

to be associated with both of these groups. They are asking persons attending these meetings to write letters to "La Gaceta", supporting the Cuban Revolutionary Government as well as the activities of the FPCC and the 26th of July Movement so that these letters will be published in "Letters to the Editor" column.

TP T-5 advised on October 4, 1961, that it was rumored that CARLOS CARBONELL, the old man who sells Cuban crackers around Ybor City, is the new leader of the July 26th Movement of Tampa. However, nothing has been heard about any actual meetings of this organization or about any activities.

REGISTRATION OF CARLOS CARBONELL
AS COORDINATOR OF THE JULY 26TH
MOVEMENT.

A short form registration slip with number 1379 was filed by CARLOS CARBONELL with the Registration Secretary, United States Department of Justice on August 21, 1961. This form showed CARLOS CARBONELL VALDEZ, born September 23, 1896, in Cuba, a United States citizen, employed at the None-Such Baking Corporation, 2111 15th Street, Tampa, Florida, and residing 3406 15th Street, Tampa, described his activities as follows:

To direct and coordinate the activities of the 26th of July Movement in the area of Tampa, Florida.

CARBONELL also admitted that he is an agent for the magazine "Bohemia" which he receives and distributes to newsstands in Tampa, Florida.

"Bohemia" is a Spanish language magazine printed in Havana, Cuba, which was expropriated by the government of FIDEL CASTRO.

Date October 13, 1961

CARLOS CARBONELL VALDEZ, 3406 15th Street, was interviewed in a Bureau car in front of his residence. He was advised that he did not have to make any statement and that any statement that he did make could be used against him in a court of law. He was advised of his right to an attorney. FLA

BORN 9/23/1896 - CUBA COORDINATOR FLA
 CARBONELL claimed that the July 26th Movement was not now active in Tampa, nor has it been active since it disbanded the early part of this year. He stated that he had registered with the Department of Justice as an agent of a foreign government upon the instructions of JOSE SANCHEZ, President and Coordinator of the July 26th Movement in New York. He did not know the name of this New York attorney. He had been advised that as coordinator of the July 26th Movement in Tampa he should register with the Department of Justice and he had been sent the necessary form to complete this registration by JOSE SANCHEZ.

CARBONELL maintained that the July 26th Movement in Tampa, is not active at the present time nor has it been active since it disbanded around the first of the year. He claimed that there are no officers in this organization other than himself, the coordinator, nor are there any active members. He registered with the Department of Justice in order to be in a position if needed, to keep alive the feeling of the revolution and to combat lies about the present government of FIDEL CASTRO in Cuba which are being spread by exiles and other people in the United States.

CARBONELL stated that he did not think that the present government in Cuba was communistic, although he stated that to him the present government in Cuba was doing the same thing in Cuba which HENRY FORD had done when he started to build automobiles in Michigan. That is FORD put up the money and told the workers that if they would work they could share the profits of the business and the same thing is true in Cuba with the government putting up the money for various projects in Cuba and the poor people who never had anything under BATISTA were finding a better way of life. Possibly this was Socialism but he could not see where it could be called communism. Cuban ties with Russia were out of economic necessity.

On 10/10/61 at Tampa, Florida File # TP 105-89

TP 97-2

b6
b7c

by SAs [redacted] and FREDERICK A. Date dictated 10/10/61
SLIGHT/blp/dmp

This document contains neither recommendations nor conclusions of the FBI. It is the property of the FBI and is loaned to your agency; it and its contents are not to be distributed outside your agency.

CARBONELL stated that he had been fired from his job as a cracker salesman for the None-Such Bakery and produced a letter postmarked September 17, 1961, addressed to the None Such Bakery. The letter contained inside this envelope was dated January 11, 1960, Tampa, Florida, and was unsigned. This letter stated that CARBONELL as an employee of the bakery was losing the bakery money because he was a communist and everyone knew this. That he had formerly been employed by Have-A-Tampa Cigar Company in Tampa, and had been fired there because he was a communist. This letter indicated that there were many loyal Americans who should be working instead of a communist.

CARBONELL stated that he had been let go on the basis of this letter and at the present time he had no employment other than selling "Bohemia" around Tampa. He stated that he receives this magazine once a week, pays the freight on the magazine and then sells it to newsstands for \$.27 a copy and it in turn is sold for \$.35. His wife is no longer working and he claimed that he was already finding it hard to make ends meet.

CARBONELL claimed that he has no intentions of returning to Cuba unless he is deported by authorities. He maintained that this was his home and he planned to stay here, and he would continue to try and combat the lies which are being spread about the present government in Cuba.

CARBONELL said that the only persons he knew of who recently have returned to Cuba were [redacted] He stated that they were presently in Cuba, but he did not know how they arrived there. [redacted] had just recently returned to Cuba, manner of departure was unknown.

USA

b6
b7c

CUBA

Sources familiar with July 26th Movement activities in Tampa Bay area were contacted during September and October, 1961, and advised that to their knowledge no Cuban school bonds or stamps were being offered for sale, nor did they possess any information regarding loyalty pledges secured by this movement as there has been no activity on the part of this movement.

RUMORED ARMS TRAINING OF INDIVIDUALS
CONNECTED WITH JULY 26TH MOVEMENT
IN TAMPA

b6
b7C

On November 2, 1961, [redacted]

[redacted] advised SAs [redacted] and FREDERICK A. SLIGHT that he had been told by an individual, whose name he could not recall, that some of the personnel at the Tampa Shipyards on the night shift were holding firearms practice. He explained that this unrecalled individual told him that while a ship was in drydock there had been a crew sandblasting the bottom of the ship. While the ship was being sandblasted, several individuals on this ship had guns and would shoot them. He explained that he had been told this about four or five months ago and had reported this to a friend of his who said he would advise the proper authorities.

[redacted] claimed this had been so long ago he had forgotten the name of the person who had told him of this and had also forgotten the names of the individuals involved. He had only been advised of their nicknames for the most part and was not personally acquainted with any of them. This unrecalled individual had also told him that this group at one time had held firearms practice outside of town. He had explained that the area where the firearms training was held was out Highway 301, south of Highway 60, near the railroad track which is about one mile south of Highway 20; that the railroad track turned right on a small road and somewhere down this road is where the group reportedly held the firearms practice one Sunday.

He has heard nothing more concerning this group or about any additional firearms training since that time. He was unable to say if these men belonged to any organized group as they were described to him as being part of the crew at the Tampa Shipyards. In the event he received any additional information he would immediately notify the property authorities himself.



UNITED STATES DEPARTMENT OF JUSTICE
FEDERAL BUREAU OF INVESTIGATION
Tampa, Florida

In Reply, Please Refer to
File No. TP 97-2

NOV 16 1961

Title JULY 26TH MOVEMENT
TAMPA, FLORIDA

Character INTERNAL SECURITY-CUBA;
REGISTRATION ACT-CUBA

Reference Report of SA FREDERICK A.
SLIGHT, dated and captioned
as above.

All sources (except any listed below) used in referenced
communication have furnished reliable information in the past.

ALL INFORMATION CONTAINED
HEREIN IS UNCLASSIFIED
DATE 02-23-2010 BY UC 60322 LP/STP/SZ



INVESTIGATION
OF JUSTICE
COMMUNICATIONS SECTION
OCT 2 6 1961
TELETYPE

- Mr. Tolson _____
- Mr. Belmont _____
- Mr. Mohr _____
- Mr. Callahan _____
- Mr. Conrad _____
- Mr. DeLoach _____
- Mr. Evans _____
- Mr. Malone _____
- Mr. Rosen _____
- Mr. Sullivan _____
- Mr. Tavel _____
- Mr. Trotter _____
- Tele. Room _____
- Mr. Ingram _____
- Miss Gandy _____

ALL INFORMATION CONTAINED
HEREIN IS UNCLASSIFIED
DATE 02-23-2010 BY UC 60322 LP/STP/SZ

URGENT 10-26-61 3-17 PM EST VED
TO DIRECTOR, FBI /109-551/

FROM SAC, TAMPA /97-2/

July 26th Movement - Tampa

JULY TWENTYSIXTH MOVEMENT, IS AND RA - CUBA. REBUAIRTELS OCTOBER
TWENTY AND TWENTYFOUR. CARLOS CARBONELL, BUFILE /105-93249/,
FURNISHED COPY OF DEPARTMENTAL LETTER TOGETHER WITH TRANSLATION OF SAME
INTO SPANISH LANGUAGE THIS DATE. ADMITTED BEING COORDINATOR OF
INSTANT GROUP IN TAMPA BUT STAES SAME DEFUNCT SINCE JANUARY SIXTYONE
AND HAS NO RECORDS PERTAINING TO MOVEMENT. DENIES KNOWLEDGE OF ANY
MEMBERSHIP OR FINANCIAL RECORDS. AWARE THAT REQUIRED TO KEEP
RECORDS OF ACTIVITIES BUT IN VIEW OF LACK OF ACTIVITY HAD NONE TO
PRODUCE. VOLUNTARILY MADE AVAILABLE RECORDS PERTAINING TO SHIPMENTS
OF QUOTE BOHEMIA UNQUOTE RECEIVED BY HIM TOGETHER WITH RECEIPTS
INDICATING PAYMENTS MADE BY HIM FOR PUBLICATION. THESE DOCUMENTS
PHOTOGRAPHED BY BUREAU AGENTS AND FILM BEING FORWARDED TO
MECHANICAL SECTION FOR DEVELOPMENT AND PRINTING. EXAMINATION COMPLETED
THIS DIVISION . RESULTS WILL BE INCORPORATED IN REPORTS TO BE SUBMITTED
END AND ACK PLS

4-20 PM OK FBI WA NH
TU DISC

WA
66 NOV 1 1961

WA 11/5/61
NOT RECORDED
87 OCT 31 1961

ORIGINAL FILED 109-5157-355

FEDERAL BUREAU OF INVESTIGATION
FOI/PA
DELETED PAGE INFORMATION SHEET
FOI/PA# 1362425-000

Total Deleted Page(s) = 26

- Page 3 ~ Duplicate;
- Page 4 ~ Duplicate;
- Page 5 ~ Duplicate;
- Page 6 ~ Duplicate;
- Page 7 ~ Duplicate;
- Page 10 ~ Duplicate;
- Page 11 ~ Duplicate;
- Page 12 ~ Duplicate;
- Page 14 ~ Duplicate;
- Page 15 ~ Duplicate;
- Page 18 ~ Duplicate;
- Page 19 ~ Duplicate;
- Page 27 ~ Duplicate;
- Page 28 ~ Duplicate;
- Page 29 ~ Duplicate;
- Page 30 ~ Duplicate;
- Page 31 ~ Duplicate;
- Page 32 ~ Duplicate;
- Page 35 ~ Duplicate;
- Page 36 ~ Duplicate;
- Page 37 ~ Duplicate;
- Page 38 ~ Duplicate;
- Page 39 ~ Duplicate;
- Page 40 ~ Duplicate;
- Page 41 ~ Duplicate;
- Page 42 ~ Duplicate;

XXXXXXXXXXXXXXXXXXXXXXXXXXXX
X Deleted Page(s) X
X No Duplication Fee X
X For this Page X
XXXXXXXXXXXXXXXXXXXXXXXXXXXX

048

b6
b7c

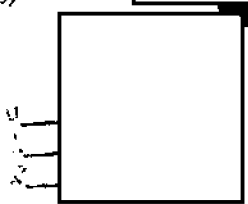

MESSAGE RELAY VIA TELETYPE

DATE 7/10/80	CLASSIFICATION CONFIDENTIAL	PRECEDENCE Priority
-----------------	---	------------------------

FM DIRECTOR FBI

TO

FEDERAL GOVERNMENT

b3
b7E

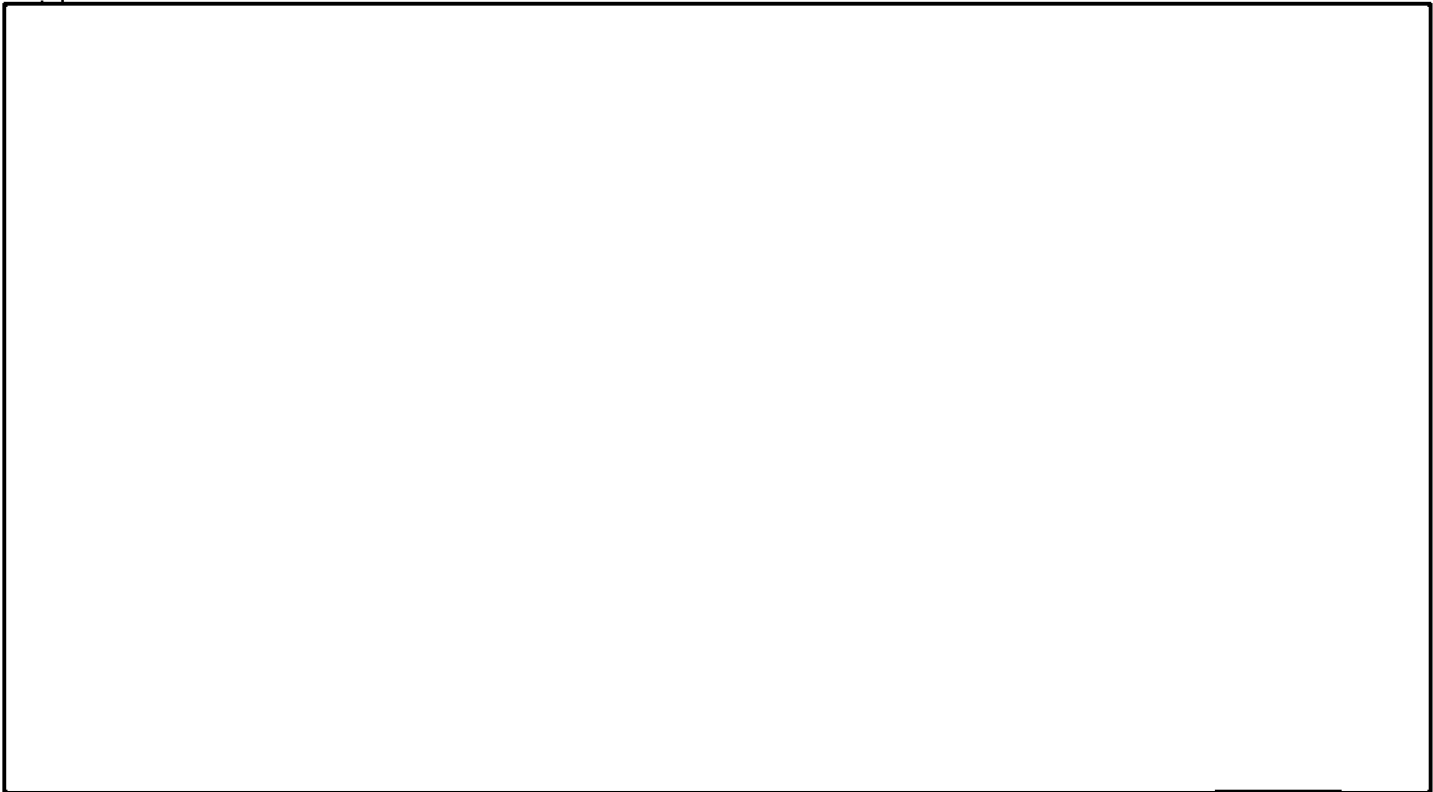

(SERVICE ALSO AVAILABLE TO GOVERNMENT AGENCIES NOT LISTED. CONTACT COMMUNICATIONS CENTER FOR ADDRESSING INFORMATION)
SUBJECT:

SEE ATTACHED

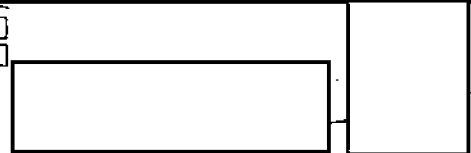

b3
b7E

JUL 21 1980

ORIGINATOR	ROOM 4045	TELE EXT. 4600
------------	--------------	-------------------

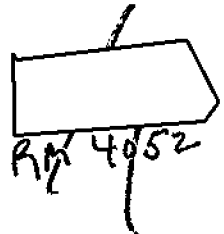
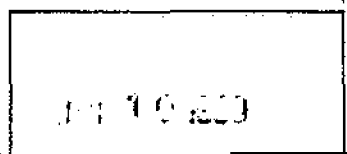
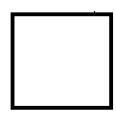

b6
b7c

DO NOT FILE WITHOUT COMMUNICATIONS STAMP

USE OF FORM 0-73

1. Only incoming teletype messages which require transmission relay may be prepared for transmission using form 0-73. Use of form 0-73 is restricted to incoming teletype messages received within the last 3 days which require transmission relay; all other teletype messages must be prepared using form 0-93.
2. Additions such as notes and administrative data for a specific addressee are not allowed. If a note or administrative data is required for a particular addressee a separate 0-73 form must be prepared.
3. The message will be transmitted just as it appears. The person approving the message is solely responsible for assuring all necessary editing changes have been made.

PREPARATION OF FORM WHICH CONSISTS OF A PREPRINTED YELLOW.

1. Complete appropriate boxes: date, classification & precedence.
2. List addresses immediately following the "TO" or place a check mark in the appropriate boxes.
3. Type or PRINT the subject in the space provided.
4. Print or type originator's name, room number and telephone extension.
5. Indicate approval for transmission by initialing the "Approved By" box.

10 JUL 80
COMMUN
CL 1
ESP

PREPARATION OF MESSAGE TO BE TRANSMITTED

1. Xerox 1 copy of incoming teletype message. A notation shall be made on the original incoming teletype "1 copy made for relay to SACS _____, (OR LEGATS) _____, (OR GOVERNMENT AGENCIES) _____."
2. Minor editing changes shall be made on the xerox as follows: using a lead pencil ONLY draw single line through the first and last lines of the heading and connect these lines from top right to bottom left forming a "Z," figure. (DO NOT OBLITERATE THE HEADING.) Use horizontal lines to delete sentences or words. Printed changes of a word or two to the text of the message may be made; however, changes to the existing text involving more than a word or two necessitate the originator to initiate a new message using form 0-93.
3. Administrative data or notes may be typed immediately following the text and will be transmitted to all addressees.
4. When using the 0-73 form to disseminate information to field offices, Legal Attaches and other Government agencies simultaneously, the text, notes and administrative data must be identical for all addressees.

1
1
1
1

Assistant Attorney General
Criminal Division

July 9, 1980

Director, FBI

b3
b6
b7C
b7E

FEDERAL GOVERNMENT

PLOT TO ASSASSINATE CUBAN
PRESIDENT FIDEL CASTRO
DURING PLANNED VISIT TO
NICARAGUA JULY, 1980

Attached is a copy of a communication which furnishes information concerning a current investigation. Exigent circumstances preclude a request for authorization in advance to utilize an electronic device to monitor and/or record private conversations with the consent of a party.

Under the provisions of Part II (a) of the Attorney General's Memorandum of October 16, 1972, to the Heads of Executive Departments and Agencies entitled, "Monitoring Private Conversations with the Consent of a Party," emergency monitoring was instituted during the authorization of an appropriate official of the FBI.

Monitoring of this conversation was authorized in the best interest of law enforcement in that it was expected to provide corroborative evidence and to protect the individual utilizing the equipment.

Further monitoring is expected in this matter and it is requested that your office approve the use of this equipment for a period of 30 days beginning the date on which you grant approval.

Enclosure

APPROVED:

Director _____
Exec. AD-Inv. _____
Exec. AD-Adm. _____
Exec. AD-LES _____

Adm. Serv. _____
Crim. Inv. _____
Ident. _____
Intell. _____
Laboratory _____

Legal Coun. _____
Plan. & Insp. _____
Rec. Mgnt. _____
Tech. Servs. _____
Training _____
Public Affs. Off. _____

JUL 16 1980

b3
b6
b7C
b7E

- Exec AD Inv. _____
- Exec AD Adm. _____
- Exec AD LES _____
- Asst. Dir.:
- Adm. Servs. _____
- Crim. Inv. _____
- Ident. _____
- Intell. _____
- Laboratory _____
- Legal Coun. _____
- Plan. & Insp. _____
- Rec. Mgnt. _____
- Tech. Servs. _____
- Training _____
- Public Affs. Off. _____
- Telephone Rm. _____
- Director's Sec'y _____

MAIL ROOM

Agreed sent to [redacted] 7/11/80

FBI/DOJ
b6
b7C

039

[redacted]

MESSAGE RELAY VIA TELETYPE

DATE 7/31/80	CLASSIFICATION Confidential	PRECEDENCE Priority
-----------------	---	------------------------

FM DIRECTOR FBI

TO Legat, Panama (VIA Mexico City)

b3
b7E

[Large redacted area]

(SERVICE ALSO AVAILABLE TO GOVERNMENT AGENCIES NOT LISTED.)

CONTACT COMMUNICATIONS CENTER FOR ADDRESSING INFORMATION)

SUBJECT:

See attached

APPROVED BY [redacted]	ORIGINATOR [redacted]	ROOM 4052	TELE EXT. 4660
---------------------------	--------------------------	--------------	-------------------

b3
b6
b7C
b7E

23 [redacted]

[redacted]

20
380

17 JUL 1980

DO NOT FILE WITHOUT COMMUNICATIONS STAMP

USE OF FORM 0-73

1. Only incoming teletype messages which require transmission relay may be prepared for transmission using form 0-73. Use of form 0-73 is restricted to incoming teletype messages received within the last 3 days which require transmission relay; all other teletype messages must be prepared using form 0-93.
2. Additions such as notes and administrative data for a specific addressee are not allowed. If a note or administrative data is required for a particular addressee a separate 0-73 form must be prepared.
3. The message will be transmitted just as it appears. The person approving the message is solely responsible for assuring all necessary editing changes have been made.

PREPARATION OF FORM WHICH CONSISTS OF A PREPRINTED YELLOW.

1. Complete appropriate boxes: date, classification & precedence.
2. List addresses immediately following the "TO" or place a check mark in the appropriate boxes.
3. Type or PRINT the subject in the space provided.
4. Print or type originator's name, room number and telephone extension.
5. Indicate approval for transmission by initialing the "Approved By" box.

PREPARATION OF MESSAGE TO BE TRANSMITTED

1. Xerox 1 copy of incoming teletype message. A notation shall be made on the original incoming teletype "1 copy made for relay to SACS _____, (OR LEGATS) _____, (OR GOVERNMENT AGENCIES) _____."
2. Minor editing changes shall be made on the xerox as follows: using a lead pencil **ONLY** draw single line through first and last lines of the heading and connect these lines from top right to bottom left forming a "Z," figure. (DO NOT OBLITERATE THE HEADING.) Use horizontal lines to delete sentences or words. Printed changes of a word or two to the text of the message may be made; however, changes to the existing text involving more than a word or two necessitate the originator to initiate a new message using form 0-93.
3. Administrative data or notes may be typed immediately following the text and will be transmitted to all addressees.
4. When using the 0-73 form to disseminate information to field offices, Legal Attaches and other Government agencies simultaneously, the text, notes and administrative data must be identical for all addressees.

COMMUNICATIONS
3 JUL 80 1428

G
A
P



DEPARTMENT OF JUSTICE
FEDERAL BUREAU OF INVESTIGATION
COMMUNICATION MESSAGE FORM

DECLASSIFICATION AUTHORITY DERIVED FROM:
FBI AUTOMATIC DECLASSIFICATION GUIDE
DATE 03-01-2023 BY: [REDACTED]

b6
b7C

PAGE 1 OF 2		CLASSIFICATION	PRECEDENCE
DATE		SECRET	PRIORITY
7/8/80			

#STPP 45 413 416 48 46 418 417 428423 H0103 1910115

4STP 082142Z JUL 80

FM DIRECTOR FBI

FEDERAL GOVERNMENT

TO
4
2
10
8
6
4

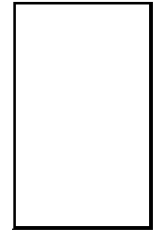
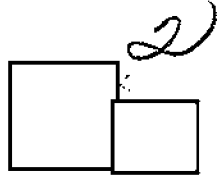
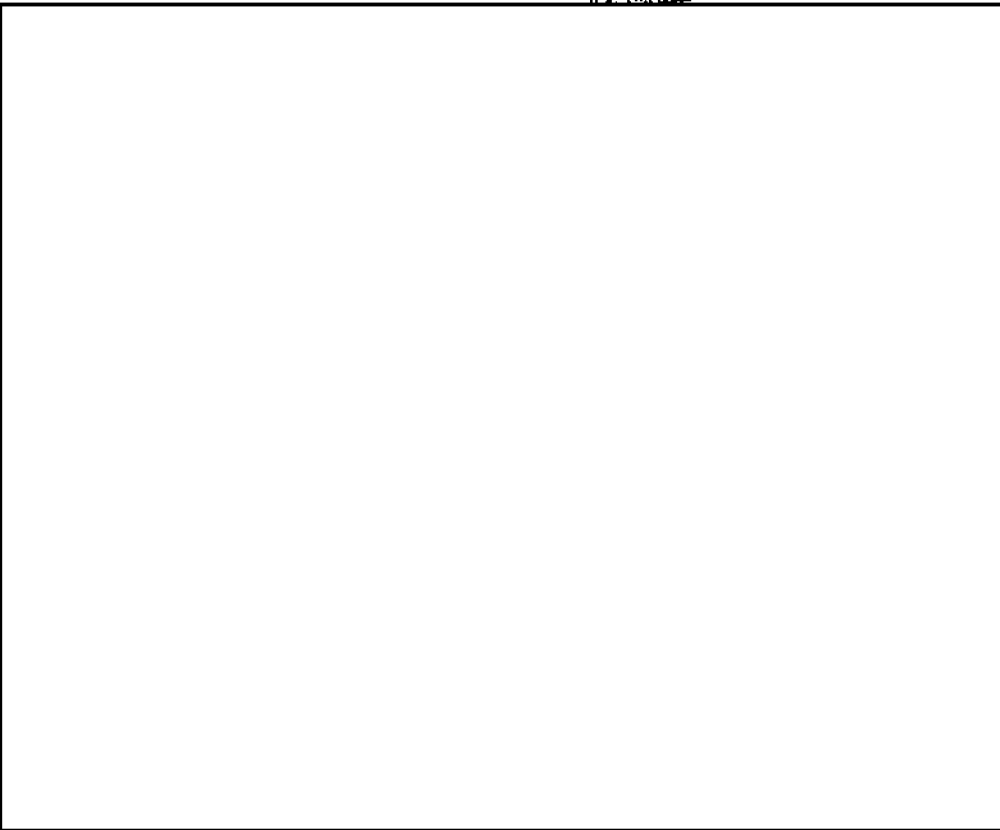

DO NOT FILE WITHOUT THIS INFO

b3
b6
b7C
b7E

BT

~~SECRET~~

PLOT BY UNKNOWN NICARAGUANS TO ASSASSINATE FIDEL CASTRO:

DO NOT FILE WITHOUT THIS INFO

APPROVED BY	DRAFTED BY	DATE	ROOM	TELE EXT.
[REDACTED]	[REDACTED]	7/8/80	4147/5	4605

b3
b6
b7C
b7E

1 - [REDACTED]	BUREAU OF INVESTIGATION SEE NOTE PAGE 5
1 - [REDACTED]	COMMUNICATIONS CENTER

06AUG 7 1980
20

ROUTE 102 ENVELOPE

JUL 9 1980

DEPARTMENT OF JUSTICE
FEDERAL BUREAU OF INVESTIGATION
COMMUNICATION MESSAGE FORM

PAGE 2

CONTINUATION SHEET

~~PAGE TWO 0103 SECRET~~

20 REFERENCE THIS BUREAU'S TELETYPE OF JULY 8, 1980,
18 CAPTIONED AS ABOVE. (U)

16 THE FOLLOWING WAS INADVERTENTLY OMITTED FROM REFERENCED
14 TELETYPE:

"WARNING NOTICE/SENSITIVE SOURCES AND METHODS. ~~NO~~
14 ~~FOREIGN DISSEMINATION.~~ NO DISSEMINATION SHOULD BE MADE WITHOUT
12 PRIOR CONCURRENCE OF THIS BUREAU." ~~SECRET~~ (U)

12 INASMUCH AS OUR SOURCE IN THIS MATTER IS SENSITIVE, IT IS
10 REQUESTED THAT THESE CAVEATS BE STRICTLY APPLIED. ~~SECRET~~ (U)

~~C AND E 5670, REASON (2) - DRD JULY 8, 2000~~

BT

8
6
4
2

DO NOT TYPE MESSAGE BELOW THIS LINE

DO NOT TYPE PAST THIS LINE

b3
b7E

PAGE THREE 7/8/80 PLOT OF UNKNOWN NICARAGUANS TO ASSASSINATE
FIDEL CASTRO

~~SECRET~~

NOTE:

Retel was disseminated 7/8/80, by CID without caveats
as MM incoming did not mention sensitivity of source. Source
is ~~ISI~~ (U)

b3
b7D
b7E

TO
A
F

[redacted]

MESSAGE RELAY VIA TELETYPE

b6
b7C

DATE 7/8/80	CLASSIFICATION Secret	PRECEDENCE Priority
----------------	-------------------------------------	------------------------

FM DIRECTOR FBI

TO

b3
b7E

FEDERAL GOVERNMENT

[Large redacted area]

(SERVICE ALSO AVAILABLE TO GOVERNMENT AGENCIES NOT LISTED.
CONTACT COMMUNICATIONS CENTER FOR ADDRESSING INFORMATION)

SUBJECT:

APPROVED BY [redacted]	ORIGINATOR [redacted]	ROOM 4052	TELE EXT. 4660
---------------------------	--------------------------	--------------	-------------------

b3
b6
b7C
b7E

[redacted]

17142 [redacted]

[redacted]

DO NOT FILE WITHOUT COMMUNICATIONS STAMP

USE OF FORM 0-73

1. Only incoming teletype messages which require transmission relay may be prepared for transmission using form 0-73. Use of form 0-73 is restricted to incoming teletype messages received within the last 3 days which require transmission relay; all other teletype messages must be prepared using form 0-93.
2. Additions such as notes and administrative data for a specific addressee are not allowed. If a note or administrative data is required for a particular addressee a separate 0-73 form must be prepared.
3. The message will be transmitted just as it appears. The person approving the message is solely responsible for assuring all necessary editing changes have been made.

PREPARATION OF FORM WHICH CONSISTS OF A PREPRINTED YELLOW.

1. Complete appropriate boxes: date, classification & precedence.
2. List addresses immediately following the "TO" or place a check mark in the appropriate boxes.
3. Type or PRINT the subject in the space provided.
4. Print or type originator's name, room number and telephone extension.
5. Indicate approval for transmission by initialing the "Approved By" box.

COMMUNICATIONS SECTION
8 JUL 80 15 42

PREPARATION OF MESSAGE TO BE TRANSMITTED

1. Xerox 1 copy of incoming teletype message. A notation shall be made on the original incoming teletype "1 copy made for relay to SACS _____, (OR LEGATS) _____, (OR GOVERNMENT AGENCIES) _____."
2. Minor editing changes shall be made on the xerox as follows: using a lead pencil ONLY draw single line through the first and last lines of the heading and connect these lines from top right to bottom left forming a "Z," figure. (DO NOT OBLITERATE THE HEADING.) Use horizontal lines to delete sentences or words. Printed changes of a word or two to the text of the message may be made; however, changes to the existing text involving more than a word or two necessitate the originator to initiate a new message using form 0-93.
3. Administrative data or notes may be typed immediately following the text and will be transmitted to all addressees.
4. When using the 0-73 form to disseminate information to field offices, Legal Attaches and other Government agencies simultaneously, the text, notes and administrative data must be identical for all addressees.

MM0014 1900130Z

PP HI

DE MM

P07 0130Z JUL 80

8 JUL 80 01 48 z

FM MIAMI [redacted] (P)

TO DIRECTOR PRIORITY

FEDERAL BUREAU OF INVESTIGATION COMMUNICATIONS SECTION

BT

~~SECRET~~

PLOT BY UNKNOWN NICARAGUANS TO ASSASSINATE FIDEL CASTRO, [redacted]

In teletype dated 7/7/80

Miami FBI advised as follows:

ON JULY 3, 1980, AN OPERATIONAL ASSET WHO HAS PROVIDED

RELIABLE INFORMATION IN THE PAST ADVISED AS FOLLOWS: ASSET

ADVISED [redacted]

[Large redacted block]

TSX

DATA 7/7/80

6/14

Exec. AD-Inv.	
Exec. AD-LES	
Exec. AD-LES	
Asst. Dir.:	
Adm. Serv.	
Crim. Inv.	
Ident.	
Intell.	
Laboratory	
Legal Coun.	
Plan. & Insp.	
Rec. Mgnt.	
Tech. Servs.	
Training	
Public Affs. Off.	
Telephone Rm.	
Director's Sec'y	

b3
b6
b7C
b7E

b3
b6
b7C
b7E

b3
b7D

b3
b6
b7
b7

PAGE TWO

[REDACTED]

~~SECRET~~

ASSET STATED THAT

[REDACTED]

[REDACTED]

[REDACTED]

(S)

(U) 4025

8

~~C AND E BY 1357, REASON 2, DRD JULY 7, 2000.~~

~~ADMINISTRATIVE OPERATIONAL ASSET IS~~

[REDACTED]

~~BEING IS REQUESTED TO FURNISH THE ABOVE TO~~

[REDACTED]

~~FOR THEIR~~

~~INFORMATION.~~

~~IT SHOULD BE NOTED THAT ASSET OBTAINED THE ABOVE INFORMATION~~

[REDACTED]

BT

b3
b7D
b7E

b3
b7D
b7E

b3
b6
b7C
b7D

UNITED STATES GOVERNMENT

UNITED STATES DEPARTMENT OF JUSTICE
FEDERAL BUREAU OF INVESTIGATION

Memorandum

- Exec AD Inv. _____
- Exec AD Adm. _____
- Exec AD LES _____
- Asst. Dir.:
- Adm. Servs. _____
- Crim. Inv. _____
- Ident. _____
- Intell. _____
- Laboratory _____
- Legal Coun. _____
- Plan. & Insp. _____
- Rec. Mgnt. _____
- Tech. Servs. _____
- Training _____
- Public Affs. Off. _____
- Telephone Rm. _____
- Director's Sec'y _____

TO : [Redacted]

DATE: 8/26/80

FROM : [Redacted]

b3
b6
b7C
b7E

SUBJECT: PLOT TO ASSASSINATE CUBAN
PRESIDENT FIDEL CASTRO
DURING PLANNED VISIT TO
NICARAGUA JULY, 1980

[Redacted]

Enclosed for filing is an approval request for consensual monitoring.

(Handwritten mark)

SEALER ENCL. ENCLOSURE ATTACHED

[Redacted]

17 SEP 11 1980

[Redacted]

b3
b6
b7C
b7E

Enclosure

[Redacted]
53 SEP 22 1980

1028



b3
b7E

~~SECRET~~

----- Working Copy -----

Precedence: ROUTINE

Date: 07/27/1998

To: Miami

From: Miami

Contact: Det. [redacted] Ext. [redacted]

Approved By: [redacted]

Drafted By: [redacted]

Case ID #: (U) ~~(S)~~ [redacted] (Pending)

Title: ~~(S)~~ UNSUBS; [redacted] ET AL;
(U) [redacted]
(U) [redacted] OO:MM

b3
b6
b7C
b7E

Synopsis: ~~(S)~~ Information received from Det. [redacted] Miami Police Department, Special Investigation Section/ Bomb Squad concerning a plot to assassinate Cuban President Fidel Castro.

b6
b7C

(U) ~~(S)~~ Derived From: G-1
Declassify On: X1

Details: (U) ~~(S)~~ On July 27, 1998, Det. [redacted] advised me of a conversation he had with a CONFIDENTIAL SOURCE. The SOURCE explained to him that [redacted]

b6
b7C
b7D

[redacted]

(U) ~~(S)~~ According to the SOURCE, [redacted]

[redacted]

b6
b7C
b7D

(U) ~~(S)~~ The SOURCE also discussed [redacted]

[redacted]

Lead (s):

set lead 1: (Adm)

Miami

Case ID : [redacted] [redacted]

~~SECRET~~

b3
b7E

Precedence: ROUTINE

Date: 07/29/1998

b6
b7C

To: Tampa
Miami

Attn: [redacted]

From: Miami

[redacted]
Contact: Det. [redacted] Ext. [redacted]

Approved By: [redacted]

Drafted By: [redacted]

b3
b6
b7C
b7E

Case ID #: [redacted] (Pending)

Title: ~~(S)~~ UNSUB: [redacted] ET AL;
[redacted]
(U) [redacted] OO:MM

Synopsis: Information received from Det. [redacted] Miami Police Department, Special Investigation Section/ Bomb Squad concerning a plot to assassinate Cuban President Fidel Castro and a failed mission by [redacted]

b6
b7C

Details: On July 29, 1998, Det. [redacted] advised me of a conversation he had with a CONFIDENTIAL SOURCE. The source provided the following information:

b6
b7C

[Large redacted area]

b6
b7C
b7D

Case ID : [redacted]

[redacted]

b3
b7E

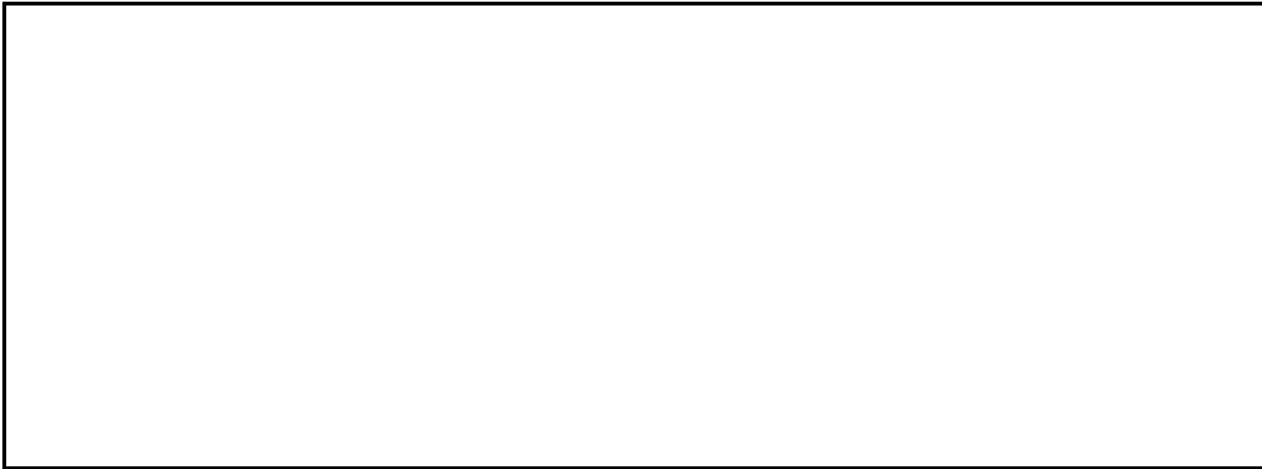

b6
b7C
b7D

LEAD (s):

Set Lead 1: (Adm)

ALL RECEIVING OFFICES

(U) ~~(S)~~ Miami

For informational purpose only

Set Lead 2:

TAMPA

AT TAMPA

(U) ~~(S)~~ Interview



phone

regarding described plot to assassinate Cuban
President Fidel Castro.

b6
b7C

FEDERAL BUREAU OF INVESTIGATION
FOI/PA
DELETED PAGE INFORMATION SHEET
FOI/PA# 1362425-000

Total Deleted Page(s) = 2
Page 1 ~ b3; b6; b7C; b7E;
Page 2 ~ b3; b6; b7C; b7D; b7E;

XXXXXXXXXXXXXXXXXXXXXXXXXXXX
X Deleted Page(s) X
X No Duplication Fee X
X For this Page X
XXXXXXXXXXXXXXXXXXXXXXXXXXXX

FEDERAL BUREAU OF INVESTIGATION
FOI/PA
DELETED PAGE INFORMATION SHEET
FOI/PA# 1362425-000

Total Deleted Page(s) = 3
Page 1 ~ b3; b7D; b7E;
Page 7 ~ b3; b7D; b7E;
Page 8 ~ b3; b7D; b7E;

XXXXXXXXXXXXXXXXXXXXXXXXXXXX
X Deleted Page(s) X
X No Duplication Fee X
X For this Page X
XXXXXXXXXXXXXXXXXXXXXXXXXXXX

FEDERAL BUREAU OF INVESTIGATION
FOI/PA
DELETED PAGE INFORMATION SHEET
FOI/PA# 1362425-000

Total Deleted Page(s) = 3
Page 1 ~ b3; b6; b7C; b7E;
Page 3 ~ b3; b7E;
Page 4 ~ b3; b7E;

XXXXXXXXXXXXXXXXXXXXXXXXXXXX
X Deleted Page(s) X
X No Duplication Fee X
X For this Page X
XXXXXXXXXXXXXXXXXXXXXXXXXXXX

(Mount Clipping in Space Below)

DEA investigará posible narcotráfico vía Cuba

Washington —(AFP)— El jefe de la Dirección contra las Drogas (DEA) de Estados Unidos, Thomas Constantine, prometió el jueves ante un panel del Congreso que investigará a fondo las alegaciones de tráfico de narcóticos a través de Cuba, después que varios congresistas denunciaron una presunta responsabilidad del régimen del gobernante Fidel Castro.

En un testimonio ante la Subcomisión de Asuntos Hemisféricos de la Cámara de Representantes, Constantine dijo que "frecuentemente" embarcaciones con drogas procedentes de América del Sur buscan refugio en aguas cubanas "donde no pueden ser perseguidos", y ni los guardacostas ni la marina cubanas toman ninguna acción para impedir que los traficantes usen sus aguas.

Declaró igualmente que vuelos de drogas "usan el espacio aéreo cubano para cubrir sus rutas", y la oficina de la DEA en Nassau, Bahamas, informó que "en los últimos dos años 28 vuelos identificados positivamente con cargas de cocaína cruzaron el espacio aéreo cubano en ruta hacia sus puntos de entrega".

"Tres de esos vuelos ocurrieron este año" puntualizó Constantine.

Agregó que "no hay evidencias de que el gobierno de Cuba sea cómplice en estas empresas de contrabando, ni tenemos información de hasta qué punto el gobierno cubano actúa, si es que lo hace, para detectar vuelos de drogas y negarles acceso a su espacio aéreo".

El congresista demócrata Robert Menéndez sugirió que el tráfico de drogas no podría hacerse sin la complicidad del gobierno de La Habana.

"Este es un régimen que tiene control sobre su territorio, como lo ha demostrado una y otra vez. Nadie penetra el espacio aéreo ni las aguas territoriales de Cuba sin que Fidel y Raúl Castro lo sepan", afirmó.

Constantine coincidió con Menéndez y prometió "perseguir a estos grupos tan activamente como sea posible".

"Yo creo que su análisis del asunto y del problema son correctos", dijo el jefe de la DEA.

La presunta responsabilidad del gobierno cubano en el narcotráfico fue denunciada también por Dan Burton, presidente de la subcomisión y varios otros miembros del panel, entre ellos los cubano-americanos Ileana Ross y Lincoln Diaz-Balart.

(Indicate page, name of newspaper, city and state.)

Date: 6/08/96
Edition: EL Nuevo Herald

Title: DEA Investigara posible Narcotrafico via Cuba

Character:
or
Classification:
Submitting Office:

Indexing:

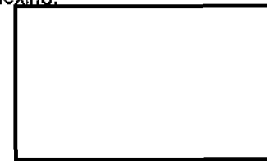

b6
b7c

b6
b7c



b6
b7c

92BMM-52044-SubN

92BMM-52044-SubN-956

SEARCHED	INDEXED
SERIALIZED	FILED
JUN 10 1996	
FBI - MIAMI	
92B-MM-52044	

(Mount Clipping in Space Below)

(Indicate page, name of newspaper, city and state.)

SUN SENTINEL

Date: JUNE 16, 1996
Edition: PAGE: 13A AND 14A

Title: DIAZ-BALART SEEKS INQUIRY OF RELEASE

Character:
or
Classification:
Submitting Office:

MIAMI DIVISION

Indexing:

Diaz-Balart seeks inquiry of release

By COLIN MCMAHON
Chicago Tribune

BOGOTA, Colombia — Since the dramatic release last week of kidnapping victim Juan Carlos Gaviria, questions about the high-profile, politically sensitive case have stretched from Bogota to Havana to Washington.

U.S. Rep. Lincoln Diaz-Balart, a Miami Republican, has asked the House Foreign Affairs Committee to investigate Gaviria's release. At issue is the involvement of Cuban President Fidel Castro and Cesar Gaviria, the victim's brother and current chief of the Organization of American States.

What are the terms of the deal be-

tween the secretary general of the OAS and the Castro regime?" Diaz-Balart asked. "Can [Cesar] Gaviria act impartially in the OAS when he has entered into deal with the kidnapers and the Castro government for the liberation of his brother?"

Juan Carlos Gaviria, 42, an architect, was released on Wednesday after more than two months in captivity. Several of his captors, escorted by representatives of the Castro government, were then allowed to board a plane to Havana.

Some, including the respected Bogota newspaper *El Tiempo*, praised the deal on Friday as the only way to save Gaviria's life. But others condemned

what they called the undermining of justice.

"This will promote more kidnappings in Colombia," said Francisco Vargas, whose group represents victims of attacks by Colombia's guerrillas.

Vargas said officials estimate that 1,400 Colombians currently are held captive, many by leftist rebels who use kidnapping as a source of income. A special anti-abduction police squad has been ineffective, critics contend, and paying ransom remains the principal path to freedom.

Gaviria was kidnapped by a group

PLEASE SEE RELEASE /14A

D-92B-MM-52044-Sub N

D-7



92B-MM-52044-Sub N 1002

b6
b7C
JUN 21 1996
FBI - MIAMI

RELEASE

FROM PAGE 13A

U.S. representative asks for inquiry into man's release

calling itself Dignity for Colombia. It made several political demands and threats, the most immediate that Gaviria would be executed if Colombia's congress exonerated President Ernesto Samper of corruption charges. It did so, overwhelmingly, on Wednesday night.

Dignity for Colombia turned out to be little more than a front slogan for Jega, a guerrilla group responsible for a series of kidnappings and, Vargas said, several assassinations.

Cuban officials said they got involved for humanitarian reasons. But in a Colombian radio interview on Friday, Castro acknowledged that ideological common ground with the leader of the kidnapping group helped in reaching a deal.

According to news reports and sources familiar with the Gaviria case, police knew the identity of the kidnappers for some time but only were able to capture members of the group Tuesday night.

The kidnappers, who were directed from a Colombian prison by a former rebel known as Bochico, were given a choice: Give up their hostage or go to prison. Bochico's first counteroffer included his own release, but authorities said no. He then negotiated safe passage for the group's leadership, and the deal was sealed with a personal letter from Castro.

By Wednesday afternoon, Gaviria was a free man.

The questions now focus on Cesar Gaviria, who was Colombia's president from 1990-1994.

Last week at the OAS annual meeting in Panama City, members approved a stinging rebuke of the United States over the Helms-Burton Act, which aims to punish some foreign companies doing business in Cuba. Diaz-Balart and others now say they wonder whether there may have been a connection between that action and the kidnapping case.

"I can state emphatically that at no time did I, as secretary general of the OAS, act in any way that could be construed as using my office to secure the release of my brother," Gaviria wrote to Diaz-Balart on Thursday. "The action taken last week . . . regarding the Helms-Burton law was solely the decision of the member states."

Still, Diaz-Balart remained critical on Friday, accusing Cesar Gaviria of having "conveyed legitimacy to terrorism."

FEDERAL BUREAU OF INVESTIGATION
FOI/PA
DELETED PAGE INFORMATION SHEET
FOI/PA# 1362425-000

Total Deleted Page(s) = 2
Page 1 ~ b3; b6; b7C; b7E;
Page 2 ~ b3; b7E;

XXXXXXXXXXXXXXXXXXXXXXXXXXXX
X Deleted Page(s) X
X No Duplication Fee X
X For this Page X
XXXXXXXXXXXXXXXXXXXXXXXXXXXX

FEDERAL BUREAU OF INVESTIGATION
FOI/PA
DELETED PAGE INFORMATION SHEET
FOI/PA# 1362425-000

Total Deleted Page(s) = 2
Page 1 ~ b3; b6; b7C; b7E;
Page 2 ~ b3; b7E;

XXXXXXXXXXXXXXXXXXXXXXXXXXXX
X Deleted Page(s) X
X No Duplication Fee X
X For this Page X
XXXXXXXXXXXXXXXXXXXXXXXXXXXX

FEDERAL BUREAU OF INVESTIGATION
FOI/PA
DELETED PAGE INFORMATION SHEET
FOI/PA# 1362425-000

Total Deleted Page(s) = 3
Page 10 ~ Duplicate;
Page 11 ~ Duplicate;
Page 12 ~ Duplicate;

XXXXXXXXXXXXXXXXXXXXXXXXXXXX
X Deleted Page(s) X
X No Duplication Fee X
X For this Page X
XXXXXXXXXXXXXXXXXXXXXXXXXXXX



CODE

TELETYPE

NITEL

b6
b7C

OCTOBER 7, 1974

1 - [redacted]

EX-103

TO SAC, SAN JUAN

REC-71

FROM DIRECTOR, FBI

Handwritten notes:
67
210
2/15/75
2/17/75

UNKNOWN SUBJECTS (3), ALSO KNOWN AS; POSSIBLE
ASSASSINATION ATTEMPT ON PREMIER FIDEL CASTRO OF CUBA,
OCTOBER-NOVEMBER, 1974, [redacted]

b3
b6
b7C
b7E

RESJTEL OCTOBER 4, 1974.

DEPARTMENT OF STATE, OCTOBER 7, 1974, ADVISED IT HAS
NO INFORMATION CONCERNING ANY ISLAND IN THE LESSER
ANTILLES WHICH IS TO BECOME INDEPENDENT IN THE IMMEDIATE
FUTURE.

SAN JUAN BE CERTAIN TO KEEP MIAMI AND THE BUREAU
APPRISED OF ALL PERTINENT DEVELOPMENTS.

b6
b7C

MIAMI ADVISED BY MAIL.

1 - Miami (BY MAIL)

FEDERAL BUREAU OF INVESTIGATION
COMMUNICATIONS SECTION

b6
b7C

OCT 07 1974
10:36 [redacted]
TELETYPE

- Assoc. Dir. _____
- Dep. AD Adm. _____
- Dep. AD Inv. _____
- Asst. Dir.:
- Admin. _____
- Comp. Syst. _____
- Ext. Affairs _____
- Files & Com. _____
- Gen. Inv. _____
- Ident. _____
- Inspection _____
- Intell. _____
- Laboratory _____
- Plan. & Eval. _____
- Spec. Inv. _____
- Training _____
- Legal Coun. _____
- Telephone Rm. _____
- Director Sec'y _____

[redacted]
(4)

SEE NOTE PAGE TWO

b6
b7C

MAIL ROOM

TELETYPE UNIT

Teletype to San Juan
Re: Unknown Subjects (3), Also Known As;
Possible Assassination Attempt on
Premier Fidel Castro of Cuba,
October-November, 1974

NOTE:

~~SECRET~~

Classified "~~Secret~~" since it contains highly sensitive information received from [redacted]

[redacted] furnished highly sensitive information indicating that [redacted]

b7D

[redacted]
[redacted] The information has been disseminated to interested U. S. Government agencies.

San Juan requested we determine through logical sources whether any island in the Lesser Antilles is to become independent in the immediate future and whether there is any information to indicate that Castro will be visiting that island.

[redacted] State Department, furnished the information originating with State set forth above to SA [redacted] on 10/7/74.

b6
b7C

~~Classified by 2111, XGDS2, Date of Declassification Indefinite.~~

~~SECRET~~

MESSAGE RELAY

Date 10/4/74

Transmit in CODE via teletype the attached PRIORITY message.
(plaintext or code) (precedence)

FROM: Director, FBI [redacted]

EX-103 REC-71

FIELD DISSEMINATION

TO:

SACS: MIAMI
SAN JUAN

[redacted]

b3
b7E

[redacted]

Assoc. Dir. _____ Classification: (Classify if to other than Bureau Office)

Dep. AD Adm. _____

Dep. AD Inv. _____

Asst. Dir.:

Admin. _____

Comp. Syst. _____

Ext. Affairs _____

Files & Com. _____

Gen. Inv. _____

Ident. _____

Inspection _____

Intell. _____

Laboratory _____

Plan. & Eval. _____

Spec. Inv. _____

Training _____

Legal Coun. _____

Telephone Rm. _____

Director Sec'y _____

Classification: (Classify if to other than Bureau Office)

~~SECRET~~

SUBJECT:

SEE NEXT PAGE

Foreign Liaison Unit

Route through for review

Cleared telephonically

with _____

FEDERAL BUREAU OF INVESTIGATION

COMMUNICATIONS SECTION

(Text of message begins on next page.)

[redacted]

TELETYPE

[redacted]

[redacted]

742 940

MAIL ROOM

TELETYPE UNIT

b6
b7c

b6
b7C
~~9 & 10 COPY
DO NOT FILE~~

NR002 SJ CODE

5:49 PM URGENT OCTOBER 4, 1974 SAA 3P

TO DIRECTOR

FROM SAN JUAN [REDACTED]

b3
b7E

ATTENTION: INTELLIGENCE DIVISION

~~SECRET~~

UNKNOWN SUBJECTS (3), ALSO KNOWN AS; POSSIBLE ASSASSINATION
ATTEMPT ON PREMIER FIDEL CASTRO OF CUBA, OCTOBER-NOVEMBER, 1974,

b3
b7E

[REDACTED]

~~THE FOLLOWING INFORMATION IS CLASSIFIED SECRET.~~

ON OCTOBER 4, 1974, [REDACTED]

[REDACTED]

ADVISED THAT

[REDACTED]

b6
b7C
b7D

END PAGE ONE

PAGE TWO

[REDACTED]

~~SECRET~~

b3
b7E

[REDACTED]

b6
b7C
b7D

ADMINISTRATIVE:

THE BUREAU IS REQUESTED TO FURNISH THE ABOVE INFORMATION TO

[REDACTED] THE U. S. DEPARTMENT OF STATE [REDACTED]

[REDACTED]

b3
b7E

[REDACTED] IN ADDITION THE U. S. STATE DEPARTMENT MAY WISH TO FURNISH THE ABOVE INFORMATION TO THE APPROPRIATE AUTHORITIES.

REQUEST OF THE BUREAU. THE BUREAU IS REQUESTED TO ASCERTAIN THROUGH LOGICAL SOURCES WHETHER ANY ISLAND IN THE LESSER ANTILLES IS TO BECOME INDEPENDENT IN THE IMMEDIATE FUTURE AND WHETHER THERE IS ANY INFORMATION TO INDICATE THAT PREMIER CASTRO WILL BE
END PAGE TWO

THIS INFORMATION IS BEING FURNISHED TO THE DEPARTMENT OF STATE FOR ANY ACTION IT DEEMS APPROPRIATE.

FOR SAC, MIAMI:

MIAMI CONTACT LOGICAL SOURCES AND FURNISH ANY PERTINENT INFORMATION DEVELOPED CONCERNING THE ABOVE MATTER

CLASSIFIED BY 422, XGDS2, INDEFINITE.

PAGE THREE

~~SECRET~~

b3
b7E

VISITING THAT ISLAND.

SAN JUAN ATTEMPTING TO DETERMINE THE IDENTITY OF ANY ISLANDS
IN THE CARIBBEAN ANTICIPATING INDEPENDENCE.

SAN JUAN INDICES INDICATE [REDACTED]

b6
b7C

SAN JUAN WILL MAINTAIN CONTACT WITH [REDACTED] FOR ADDITIONAL
DETAILS AND INVESTIGATION CONTINUING. SUCOP.

b6
b7C
b7D

~~CLASSIFIED BY 3713, XGDS 2, INDEFINITE.~~

END.

Intelligence Division

INFORMATIVE NOTE

Date 10/4/74

On 10/4/74, [redacted] advised of highly sensitive information from a reliable source which indicated

b6
b7C
b7D

[redacted]

This information has been furnished by teletype to the Department of State for any action it deems appropriate [redacted]

[redacted] Copies have also been furnished to the Assistant Attorney General, Criminal Division (Internal Security/General Crimes Sections).

b3
b7E

The Miami Office has been furnished information in the attached teletype and instructed to contact logical sources and furnish any pertinent information developed regarding the above matter.

[redacted] [redacted] [redacted] [redacted]

b6
b7C

UNITED STATES GOVERNMENT

Memorandum

TO : DIRECTOR, FBI

DATE: 2/3/75

FROM : *WJ/ges* SAC, MIAMI [redacted] (RUC) [redacted]

b3
b6
b7C
b7E

SUBJECT: [redacted] UNSUBS (3) aka;
POSSIBLE ASSASSINATION ATTEMPT
ON PREMIER FIDEL CASTRO,
October - November, 1974 *victim*
[redacted]
(OO: SJ)

5
2

Re Bureau teletype dated 10/4/74 and Bureau teletype to San Juan dated 10/7/74.

There is always a great deal of loose talk in Miami concerning the assassination of FIDEL CASTRO and every day in frequent gatherings some irate Cuban states that he is going to kill FIDEL CASTRO. However, no specific plans to kill FIDEL CASTRO have come to the attention of Miami informants:

[redacted] contacted by SA [redacted]

[redacted] contacted by SA [redacted]

b6
b7C
b7D

[redacted] contacted by SA [redacted]

Inasmuch as logical Miami informants have failed to obtain any information indicating plans to kill FIDEL CASTRO, no additional investigation by the Miami Division is indicated.

[redacted] (2) Bureau (RM)
1 - Miami 1 - San Juan (RM)
[redacted]
(4)

EX-101

REC-741

[redacted]

FEB 7 1975

b3
b6
b7C
b7E

[redacted]



354
FF

UNITED STATES GOVERNMENT

Memorandum

TO : DIRECTOR, FBI

DATE: 2-19-75

FROM : SAC, SAN JUAN [redacted] (C)

SUBJECT: UNSUBS (3); AKA POSSIBLE
ASSASSINATION ATTEMPT ON
PREMIER FIDEL CASTRO OF CUBA,
OCTOBER-NOVEMBER, 1974

[redacted] 2

b3
b6
b7C
b7E

[redacted]
OO: SAN JUAN

Re San Juan teletype to the Bureau, 10-4-74,
Bureau teletype to San Juan, 10-7-74, and Miami letter to
the Bureau, 2-3-75.

For information of the Bureau, continued contact
has been maintained with [redacted]

[redacted] advised

b6
b7C
b7D

On the dates indicated, the following sources familiar
with Cuban activities in Puerto Rico were contacted and could
furnish no information relating to this matter:

<u>Source</u>	<u>Date Contacted</u>	<u>Contacting Agent</u>
[redacted]	1-22-75 1-28-75 and 2-12-75 1-20-75 and 2-3-75	[redacted]

b3
b6
b7C
b7D
b7E

REC 44

[redacted]

2 - Bureau
1 - San Juan
[redacted] 1975
(5)

EX-101

17 FEB 24 1975

Buy U.S. Savings Bonds Regularly on the Payroll Savings Plan

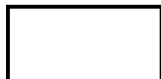

b3
b7E

Source

Date Contacted

Contacting Agent



1-8-75 and
1-24-75
1-8-75 and
1-24-75
2-4-75

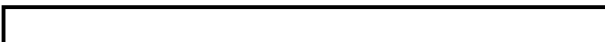

b6
b7C
b7D

Inasmuch as  could furnish no additional information relating to this matter, and since all logical San Juan and Miami informants have failed to obtain any information indicating plans to kill FIDEL CASTRO, no additional investigation by the San Juan Office is contemplated and this case is being closed.

b6
b7C
b7D

(E) VISIT OF CUBAN PRESIDENT OSVALDO DORTICOS OR PRIME MINISTER FIDEL CASTRO TO CANADA IN JULY, 1967 -- [redacted]

[redacted] has advised that [redacted]
[redacted]

b7D

[redacted] be alert to possible changes which may be announced in the press or may become available through other sources.

[redacted]
[redacted]

b7D

[redacted] Since anti-Castro Cuban exiles in this country in the past have travelled to Canada to attack Cuban establishments there, we can expect that they will plan various militant anti-Castro activities to be carried out in connection with this visit.

Each office alert logical sources and informants and advise the Bureau of any pertinent information received by the most expeditious means warranted [redacted] Submit data under caption of "Visit of Cuban President Osvaldo Dorticos or Prime Minister Fidel Castro to Canada in July, 1967, [redacted]"

b3
b7D
b7E

It is noted that when President Dorticos came to the U. S. in 1962 to attend a United Nations session he was accompanied by an individual who was subsequently arrested in this country for conspiracy to commit sabotage in New York City. We can expect that such individuals will accompany Dorticos or Castro on the proposed visit. In addition, [redacted]

[redacted]

b3
b7E

[redacted] Keep Bureau currently advised of any pertinent information received along these lines under an appropriate caption.

2-28-67
SAC LETTER 67-14

[redacted]

SEARCHED [redacted] INDEXED [redacted]
SERIALIZED [redacted] FILED [redacted]
MAR 3 1967
FBI - SAN ANTONIO

b3
b6
b7C
b7E

① JA

[redacted]

MEMO TO ALL AGENTS
NO. 74

San Antonio, Texas
3/20/67

RE: VISIT OF CUBAN PRESIDENT
OSVALDO DORTICOS OR
PRIME MINISTER FIDEL CASTRO
TO CANADA IN JULY, 1967

As reference indicates. [redacted]

[redacted]

b7D

All Agents are requested to alert logical sources
and informants so that the Bureau may be advised of any
pertinent information received.

[redacted]

b6
b7C

1-SAC
1-ASAC
1-Supervisor
1-Each Agent (52)

1-[redacted]

1-66-125

[redacted]

(57)

[redacted]

b3
b6
b7C
b7E

Searched [redacted]
Serialized [redacted]
Indexed [redacted]
Filed [redacted]

b3
b7E

[redacted]

DIRECTOR, FBI

4/20/67

SAC, SAN ANTONIO [redacted] (RUC)

b3
b7E

VISIT OF CUBAN PRESIDENT
OSVALDO DORTICOS or
PRIME MINISTER FIDEL CASTRO
TO CANADA IN JULY, 1967

Re SAC letter 67-14, dated 2/28/67.

Informants and sources of the San Antonio Division
have been alerted to the contents of the referenced communication.

If any positive information comes to the attention
of the San Antonio Division, the Bureau will be immediately
advised of all pertinent details.

*stripped
& consolidated
5-19-70*

b3
b6
b7C
b7E

2 - Bureau
1 - San Antonio

[redacted]

(3)

[redacted]

[redacted]

[redacted]

FEDERAL BUREAU OF INVESTIGATION
FOI/PA
DELETED PAGE INFORMATION SHEET
FOI/PA# 1362425-000

Total Deleted Page(s) = 2
Page 3 ~ b3; b6; b7C; b7E;
Page 4 ~ b3; b7E;

XXXXXXXXXXXXXXXXXXXXXXXXXXXX
X Deleted Page(s) X
X No Duplication Fee X
X For this Page X
XXXXXXXXXXXXXXXXXXXXXXXXXXXX

9/8/67

Airtel

To: SAC, New York

From: Director, FBI

**ALLEGED PLAN OF CUBAN EXILES
TO KIDNAP VIDEL CASTRO**

[Redacted]

[Redacted]

b3
b7E

unw ref

Enclosed for each recipient is a copy

[Redacted]

[Redacted]

New York contact established sources and informants

[Redacted]

b3
b6
b7C
b7E

Furnish results in form suitable for dissemination.

Enclosure

- 1 - Miami (Enclosure)
- 1 - San Juan (Enclosure)
- 1 - WFO (Enclosure)
- 1 - Santo Domingo (Enclosure)

[Redacted]

[Redacted]

[Redacted]

[Redacted]

[Redacted]

[Redacted]

b3
b6
b7C
b7E

[Redacted]

SEARCHED
SERIALIZED

INDEXED
FILED

APR 25 1964

[Redacted]

b3
b6
b7C
b7E

3-04 PM [REDACTED]

NR -----2----- 145 PM URGENT 9-21-67 [REDACTED]

TO DIRECTOR AND NEW YORK

NEW YORK VIA WA (ENCODED)

FROM LEGAT SANTO DOMINGO 3P

ALLEGED PLAN OF CUBAN EXILES TO KIDNAP FIDEL CASTRO, [REDACTED]

RE BUREAU AIRTEL SEPTEMBER EIGHT LAST CAPTIONED AS ABOVE, [REDACTED]

[REDACTED] BUTEL AUGUST TWENTYFOUR

LAST CAPTIONED [REDACTED] AND MYTEL AUGUST TWENTYONE

LAST, LIKEWISE CAPTIONED.

AS SET FORTH IN [REDACTED]

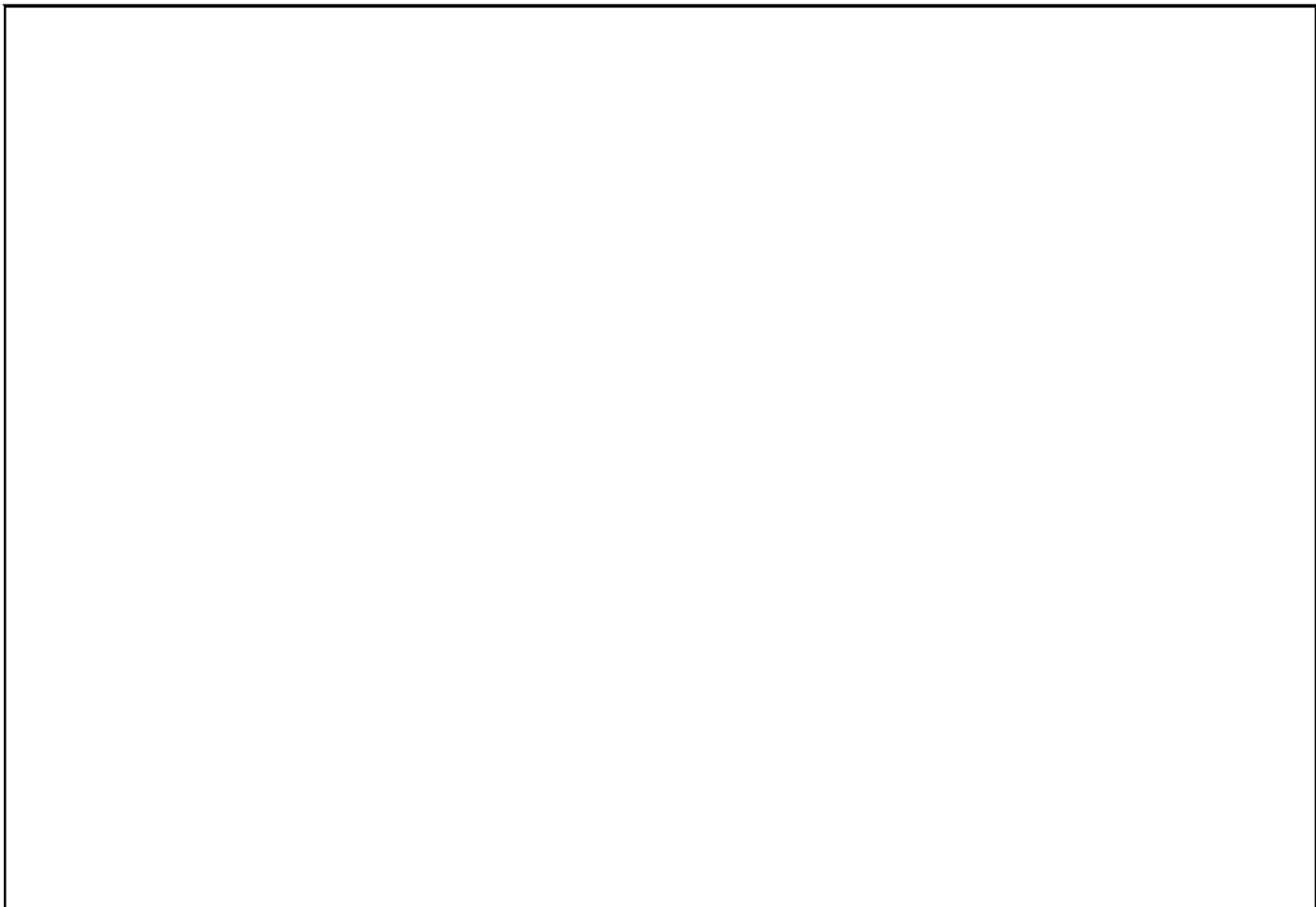

END PAGE ONE

b6
b7C

b3
b7E

b3
b6
b7C
b7E

b3
b6
b7C
b7D
b7E



b3
b6
b7C
b7E

DISCREET INVESTIGATION BY SANTO DOMINGO HAS DETERMINED NO INFORMATION WHICH WOULD INDICATE EITHER [REDACTED] OR [REDACTED]

b6
b7C

[REDACTED] HAS TRAVELED TO THE DR DURING THE MONTH OF AUGUST, ONE NINE SIX SEVEN.

FOR THE INFORMATION OF THE BUREAU, LEGAT TELETYPE CAPTIONED

[REDACTED] ADVISED THIS INDIVIDUAL, A CUBAN EXILE FORMERLY ASSOCIATED WITH [REDACTED] RESIDING IN [REDACTED]

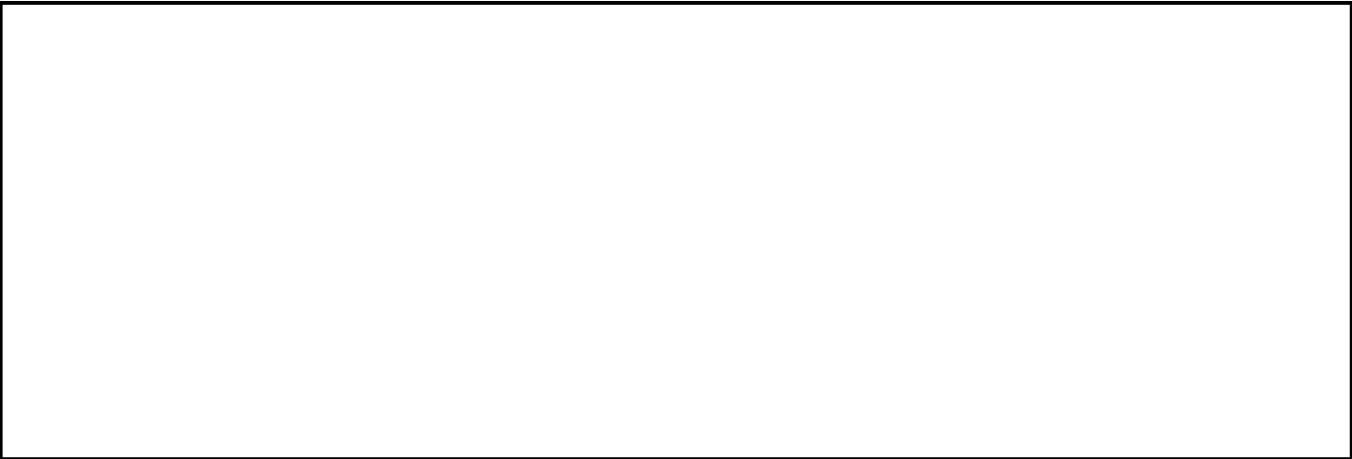

b3
b6
b7C
b7E

[REDACTED] REFERENCED BUTEL SET FORTH

INFORMATION CONCERNING ONE [REDACTED], BORN ON [REDACTED] ADDRESS [REDACTED]

[REDACTED] THIS INDIVIDUAL WAS ARRESTED BY U. S. CUSTOMS, MIAMI, AT [REDACTED]

b6
b7C

END PAGE TWO

5-9

PAGE THREE

ON JANUARY THREE LAST AND CHARGED WITH ILLEGAL EXPORTATION OF ARMS FROM THE U. S OF SEVENTYSIX INDIVIDUALS ARRESTED, CHARGES AGAINST ALL BUT SIX, INCLUDING [REDACTED] WERE SUBSEQUENTLY DROPPED. THE FEBRUARY TWENTYFIVE, ONE NINE SIX FIVE ISSUE OF "BOHEMIA", HAVANA, CUBA, MENTIONED [REDACTED]

b6
b7C

[REDACTED]

IT IS THE OPINION OF LEGAT THAT [REDACTED] IS POSSIBLY IDENTICAL WITH (FNU) [REDACTED] DESCRIBED AS INVOLVED IN CUBAN EXILE PLOT TO KIDNAP CASTRO. IT IS NOTED THAT [REDACTED]

b3
b6
b7C
b7E

[REDACTED] INVESTIGATION CONDUCTED THROUGH SOURCES OF SAN HAS DETERMINED NO INFORMATION CONCERNING ANY CUBAN NATIONAL NAMED [REDACTED] HAVING TRAVELED TO OR FROM THE DR DURING PERTINENT PERIOD.

b3
b6
b7C
b7E

[REDACTED]

BUREAU IS REQUESTED TO FURNISH THIS INFORMATION TO NEW YORK IN VIEW OF INVESTIGATION BEING CONDUCTED FOR PURPOSE OF DISCREETLY IDENTIFYING FNU [REDACTED] BUREAU IS ALSO REQUESTED TO FURNISH THIS DATA TO MIAMI, IF DEEMED APPROPRIATE, FOR PURPOSE OF DETERMINING IF [REDACTED] IS PRESENTLY IN MIAMI AND TO DETERMINE THROUGH SOURCES ANY INFORMATION CONCERNING HIS ACTIVITIES IN THE DR.

b6
b7C

END

FBI SAN JUAN RGR RELAY [REDACTED]
ELR R RELAY

b6
b7C

TO: SAC,

- Albany
- Albuquerque
- Anchorage
- Atlanta
- Baltimore
- Birmingham
- Boston
- Buffalo
- Butte
- Charlotte
- Chicago
- Cincinnati
- Cleveland
- Columbia
- Dallas
- Denver
- Detroit
- El Paso
- Honolulu

- Houston
- Indianapolis
- Jackson
- Jacksonville
- Kansas City
- Knoxville
- Las Vegas
- Little Rock
- Los Angeles
- Louisville
- Memphis
- Miami
- Milwaukee
- Minneapolis
- Mobile
- Newark
- New Haven
- New Orleans

- New York City
- Norfolk
- Oklahoma City
- Omaha
- Philadelphia
- Phoenix
- Pittsburgh
- Portland
- Richmond
- St. Louis
- Salt Lake City
- San Antonio
- San Diego
- San Francisco
- San Juan
- Savannah
- Seattle
- Springfield

- Tampa
- Washington Field
- Quantico

TO LEGAT:

- Bern
- Bonn
- Buenos Aires
- Hong Kong
- London
- Manila
- Mexico, D.F.
- Ottawa
- Paris
- Rome
- Santo Domingo
- Tokyo

Date SEP 26 1967

RE:

For information Retention optional For appropriate action Surep, by _____

The enclosed is for your information. If used in a future report, conceal all sources, paraphrase contents.

Enclosed are corrected pages from report of SA _____ dated _____

Remarks:

See Buairtel to NY 9/8/67.

SEARCHED	INDEXED
SERIALIZED	FILED
SEP 26 1967	

b3
b6
b7C
b7E

Enc.
Bufile
Urfile



UNITED STATES DEPARTMENT OF JUSTICE

FEDERAL BUREAU OF INVESTIGATION

New York, New York

October 9, 1967

~~SECRET~~

~~NO FOREIGN DISSEMINATION~~

In Reply, Please Refer to
File No.

Alleged Plan of Cuban Exiles
To Kidnap Fidel Castro

NY T-1, [redacted]

[redacted] advised that information was
received [redacted]

b3
b6
b7C
b7D
b7E

[redacted]

advised that [redacted]

[redacted]

NY T-1 advised that [redacted]

[redacted]

b3
b6
b7C
b7D
b7E

NY T-1 stated that [redacted]

[redacted]

b3
b6
b7C
b7D
b7E

NY T-1 advised that [redacted]

[redacted]

b3
b6
b7C
b7D
b7E

Sources and informants familiar with anti-Castro ac-
tivities in the New York area advised on September 15, 1967,
that they had no information concerning the above mentioned
matter nor had they any information as to the true identity of
FNU [redacted]

12

b6
b7C

This document contains neither recommendations nor
conclusions of the FBI. It is the property of the
FBI and loaned to your agency; it and its contents
are not to be distributed outside your agency.

SEARCHED [redacted] INDEXED [redacted]
SERIAL [redacted] FILED [redacted]
OCT 10 1967

b3
b6
b7C
b7E

~~GROUP I
Excluded from automatic downgrading
and declassification.
SECRET - NO FOREIGN DISSEMINATION~~

~~SECRET - NO FOREIGN DISSEMINATION~~

Alledged Plan of Cuban Exiles
To Kidnap Fidel Castro

[redacted]
[redacted]
[redacted] on September 19, 1967, advised that [redacted] of New York City, had been in his office that day and had informed [redacted] that he had recently returned from Santo Domingo, Dominican Republic. [redacted] identified [redacted] as a friend of Dominican President Joaquin Balaguer.

b6
b7C

[redacted] advised that in his conference with [redacted] [redacted] did not go into any details but had told [redacted] that he was working on a plan of getting rid of Fidel Castro. [redacted] stated that [redacted] indicated to him that something did happen inside Cuba concerning Castro but declined to give [redacted] any information concerning any plan or plot to eliminate Castro.

b6
b7C

[redacted] also advised on September 19, 1967, that [redacted] has always been anti-Castro in his sentiments and actions and that presumably [redacted] had spent some time in the Dominican Republic, and at one time had been designated as [redacted]

b6
b7C

[redacted] also stated that [redacted]
[redacted]

The files of the New York Office reflect that [redacted] [redacted] was interviewed in New York City by Special Agents of the Federal Bureau of Investigation on February 14, 1962. During this interview [redacted] advised that his full name was [redacted] and that he was born on [redacted] At that time [redacted] was residing at [redacted]

b6
b7C

During this interview [redacted] stated that he had formerly been employed as [redacted]
[redacted]

b6
b7C

~~SECRET-NO FOREIGN DISSEMINATION~~

~~SECRET - NO FOREIGN DISSEMINATION~~

Alleged Plan of Cuban Exiles
To Kidnap Fidel Castro

[redacted] This activity [redacted]
tor, according to [redacted] took place before and during the
regime of ex-president Fulgencio Batista.

b6
b7c

[redacted]

During the course of the interview on February 14, 1962,
[redacted] admitted having spent time in the Dominican Republic and
also of having received money from [redacted]
[redacted] for furnishing him with information
on Dominican Communists. [redacted] also stated that before he
left the Dominican Republic he had received a letter which
was dated July 6, 1961, from [redacted]

b6
b7c

While [redacted] was in the Dominican Republic he or-
ganized an anti-Cuban movement which he called "Movimiento
Revolucionario Cubano (Cuban Revolutionary Movement) (MRC)".
A letterhead of the MRC reflected that this organization had
for its motto, "Against the Fidelista-Soviet Tyranny Which
Opposes Our Dear Fatherland". [redacted]

b6
b7c

[redacted] While
[redacted] was in the Dominican Republic he also spoke over the
radio on Radio Caribe and La Voz Del Tropico at various times,
and all his talks were of an anti-Castro nature.

-3*-

~~SECRET - NO FOREIGN DISSEMINATION~~

DIRECTOR, FBI

OCT 9 1967

SAC, NEW YORK [redacted] (C)

ALLEGED PLAN OF CUBAN EXILES TO KIDNAP FIDEL CASTRO

[redacted]
(OO: NY)

b3
b6
b7C
b7E

ReBuairtel dated 9/8/67, captioned as above, enclosing a copy of [redacted]

Enclosed herewith for the Bureau are 12 copies of a LHM setting forth the results of investigation conducted in this matter. An extra copy is furnished to the Bureau for dissemination to Legat, Santo Domingo.

Information copies are also being sent to Miami, San Juan and WFO.

NY T-1, mentioned in enclosed LHM, is [redacted]

b3
b7E

For the information of the Bureau, [redacted]

[redacted]

b3
b6
b7C
b7E

Sources and informants, who were contacted negatively regarding (FNU) [redacted] on 9/15/67 are identified as [redacted]

b6
b7C
b7D

A review of NY indices fails to reflect any information identifiable with [redacted]

b6
b7C

From information contained in enclosed LHM, as furnished by [redacted], it would appear that [redacted]

b6
b7C

- 3-Bureau (Encls. 12) (RM)
- 1-Legat, Santo Domingo
- 1-Miami (Encl. 1) (Info) (RM)
- 1-San Juan (Encl. 1) (Info) (RM)
- 1-Washington Field (Encl. 1) (Info) (RM)
- 1-New York

[redacted]

[redacted]
(7)

SEARCHED [redacted] INDEXED [redacted]
SERIALIZED [redacted] FILED [redacted]
OCT 10 1967

b3
b6
b7C
b7E

b3
b7E

[Redacted]

[Redacted] is possibly identical with [Redacted]
[Redacted]

b3
b6
b7C
b7E

The enclosed LHM has been classified "~~Secret-No~~
~~Foreign Dissemination~~" because it contains information [Redacted]
[Redacted]

SAC, New York [redacted]

10/18/67

Director, FBI [redacted]

b3
b7E

**ALLEGED PLAN OF CUBAN EXILES
TO KIDNAP FIDEL CASTRO**

[redacted]

Reur closing letter 10/9/67 with enclosure. This letter indicated that [redacted] may be identical with [redacted]

b3
b6
b7C
b7E

[redacted]

Furnish copy of enclosure to relet to [redacted] locally.

b7E

New York bring activities of [redacted] up to date. When investigation completed, submit recommendations relative to interview. Submit results under [redacted] caption.

b6
b7C

Miami review its indices to be certain that New York has all pertinent information concerning [redacted]

b6
b7C

The attention of New York is directed to WFOairtel 7/23/64, captioned "Cuban Exile March to Washington, D. C., July 21, 1964, [redacted]" with enclosure. The enclosure on page seven contains information pertaining to [redacted]

b3
b6
b7C
b7E

- 2 - Miami
- 1 - San Juan
- 1 - WFO
- 1 - Santo Domingo

[redacted]

[redacted]

SEARCHED [redacted] INDEXED [redacted]
 SERIALIZED [redacted] FILED [redacted]
 OCT 19 1967
 [redacted]

b3
b6
b7C
b7E

CONSOLIDATED
Date: AUG 12 1971
Initials: [redacted]

NR012 WA CODE

221PM URGENT 12-22-72 []

b6
b7C

TO: MIAMI

NEWARK

NEW YORK

SAN JUAN

WASHINGTON FIELD

FROM: FOR THE ACTING DIRECTOR, FBI 1P

W. MARK FELT

ACTING ASSOCIATE DIRECTOR []

b3
b7E

VISIT TO CANADA OF PREMIER FIDEL CASTRO, 12/25-26/72; []

[] HAS ADVISED THAT []

[]

b7D

IN VIEW OF POSSIBILITY ANTI-CASTROITES WILL BECOME AWARE OF
CASTRO'S VISIT TO CANADA AND ATTEMPT TO TAKE SOME POSITIVE ACTION A-
GAINST HIM, RECIPIENTS SHOULD BE ALERT TO ANY INFORMATION INDICATING
SUCH INDIVIDUALS ARE PROCEEDING TO CANADA DURING PERTINENT PERIOD.
ADVISE BUREAU OF SUCH DATA BY TELETYPE SUITABLE FOR DISSEMINATION.

END AND PLS ACK FOR THREE

SAT FBI WFO ACK FOR NR007 NR009 NR012 []

b3
b6
b7C
b7E

[]
[]
[]
[]
12/22/72

ACTING DIRECTOR, FBI [redacted]

1/26/73

SAC, WFO [redacted] (RUC)

b3
b7E

VISIT TO CANADA OF PREMIER FIDEL
CASTRO, 12/25-26/72

[redacted]

As no information was developed by WFO regarding
captioned visit and as the visit is now completed, this matter
is being closed.

[redacted] 2- Bureau
1- WFO
[redacted]
(3)

[redacted]

[redacted]
[redacted]
FILE STRIPPED
Date: 2/1/73
[redacted]

[redacted]
Searched [redacted]
Serialized [redacted]
Indexed [redacted]
Date: 1/26/73
[redacted]

b3
b6
b7C
b7E

Airtel

To: SAC, New York

6/25/73

From: Acting Director, FBI

POSSIBLE ATTENDANCE OF CUBAN
PRIME MINISTER FIDEL CASTRO AT
UNITED NATIONS GENERAL ASSEMBLY,
FALL, 1973



NI

b3
b7E



an

b3
b7E

item from the newspaper "El Nacional", Caracas, Venezuela, dated
6/17/73.

The newspaper reported that a meeting between Venezuelan
President Rafael Caldera and Fidel Castro was being planned and that
the meeting reportedly would be held in New York City while both were
attending the United Nations General Assembly. It was also stated
that President Caldera would probably not stop over in Havana en route
to the United Nations.

The Bureau has received nothing from other agencies con-
cerning Castro's visit to the U.S. New York should be most alert to
any information indicating such a trip will be made and should main-
tain close liaison with the U.S. Mission to the United Nations in this
regard. Other recipients of this airtel should be alerted by New York
if any positive information is developed concerning the visit. De-
tailed instructions will be issued in the event the trip does materi-
alize.

- 1 - Miami
- 1 - San Juan
- ① - WFO
- 1 - Mexico

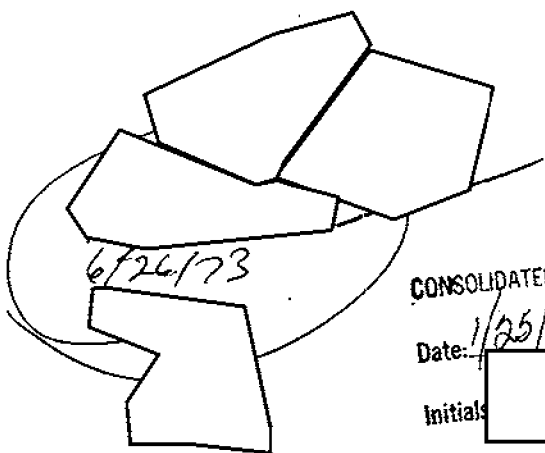
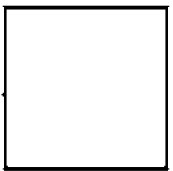

6/26/73

CONSOLIDATED

Date: 6/25/74

Initials



SEARCHED [redacted] INDEXED [redacted]
SERIAL [redacted] FILED [redacted]

JUN 25 1973

FBI - WASH. FIELD OFFICE

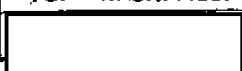

b3
b6
b7C
b7E

FEDERAL BUREAU OF INVESTIGATION
FOI/PA
DELETED PAGE INFORMATION SHEET
FOI/PA# 1362425-000

Total Deleted Page(s) = 28

- Page 33 ~ b6; b7C;
- Page 36 ~ b6; b7C;
- Page 46 ~ Duplicate;
- Page 82 ~ b3; b6; b7C; b7E;
- Page 83 ~ b3; b6; b7C; b7E;
- Page 84 ~ b3; b6; b7C; b7E;
- Page 85 ~ b3; b6; b7C; b7E;
- Page 86 ~ b3; b6; b7C; b7E;
- Page 96 ~ b6; b7C; b7D;
- Page 109 ~ b3; b7E;
- Page 110 ~ b3; b7E;
- Page 111 ~ b3; b7E;
- Page 115 ~ b3; b6; b7C; b7E;
- Page 118 ~ b3; b6; b7C; b7E;
- Page 119 ~ b3; b6; b7C; b7E;
- Page 142 ~ b3; b6; b7C; b7E;
- Page 143 ~ b3; b6; b7C; b7E;
- Page 145 ~ Duplicate;
- Page 157 ~ b3; b6; b7C; b7E;
- Page 158 ~ b3; b6; b7C; b7E;
- Page 175 ~ Duplicate;
- Page 176 ~ Duplicate;
- Page 177 ~ Duplicate;
- Page 178 ~ Duplicate;
- Page 179 ~ Duplicate;
- Page 180 ~ Duplicate;
- Page 185 ~ Duplicate;
- Page 186 ~ Duplicate;

XXXXXXXXXXXXXXXXXXXXXXXXXXXXX
X Deleted Page(s) X
X No Duplication Fee X
X For this Page X
XXXXXXXXXXXXXXXXXXXXXXXXXXXXX

FEDERAL BUREAU OF INVESTIGATION

~~CONFIDENTIAL~~

FORM No. 1
THIS CASE ORIGINATED AT **NEW YORK CITY**

REPORT MADE AT MIAMI	DATE WHEN MADE JAN 4 1956	PERIOD FOR WHICH MADE 11/15, 21-24, 27-29; 12/1, 2, 5, 6, 7, 9, 10, 13, 20, 21/55.	REPORT MADE BY [redacted]
TITLE CHANGED: FIDEL ALEJANDRO CASTRO RUZ, wa. Fidel Castro Ruz; JUAN MANUEL MARQUEZ			CHARACTER OF CASE [redacted]

b3
b6
b7c
b7E

SYNOPSIS OF FACTS:

FIDEL CASTRO and MANUEL MARQUEZ in Miami during November and December, 1955. CASTRO was principal speaker at public meetings held 11/20/55, Miami, 11/27/55 Tampa, and 12/7/55 Key West, Fla. CASTRO advocated overthrow of FULGENCIO BATISTA, President of Cuba, by force, unless BATISTA gives up reign of his government within near future. CASTRO took up collections of money and insinuated that this might be used to purchase arms, but indicated he would not violate any laws of U.S. PATRIOTIC CLUBS OF JULY 26 organized Tampa and Miami, Fla. CASTRO departed U.S. at Miami for Mexico on 12/10/55 and indicated he hopes to return to U.S.

- P -

DETAILS:

The title of this case is being marked Changed to denote subject's full name, FIDEL ALEJANDRO CASTRO RUZ. He is commonly known as FIDEL CASTRO.

AT MIAMI, FLORIDA

On November 15, 1955 Miami Confidential Informant T-1, who has furnished reliable information in the past,

Correction per
0-17 [redacted] 1/12/56

APPROVED AND FORWARDED: [redacted]	SPECIAL AGENT IN CHARGE [redacted]	DO NOT WRITE IN THESE SPACES	
COPIES OF THIS REPORT 8 - Bureau [redacted] (RM) 2 - Miami [redacted]		SEARCHED [redacted] INDEXED [redacted] SERIALIZED [redacted] FILED [redacted]	[redacted]
(COPIES CONTINUED PAGE 2)		JAN 5 1956 FBI - WASHINGTON	[redacted]

b3
b6
b7c
b7E

PROPERTY OF FBI--This report is loaned to you by the FBI, and neither it nor its contents are to be distributed outside the agency to which loaned.

~~CONFIDENTIAL~~

Filing
1/12/56



b3
b7E

COPIES THIS REPORT (Cont'd)

- 1 - U.S. Customs, Miami (RM)
- 1 - INS, Miami (RM)
- 3 - New York (RM)
- ② - Washington Field (RM)

* * * * *

advised that FIDEL CASTRO RUZ and JUAN MANUEL MARQUEZ arrived in Miami sometime during the preceding week from Mexico City, where they had been attempting to collect funds for the avowed purpose of overthrowing the BATISTA Government in Cuba.

T-1 said that



had been promoting CASTRO and MARQUEZ in Miami.

b6
b7C

With reference to [redacted] it is to be noted that during the investigation of the case entitled "CARLOS PRIO SOCARRAS, ET AL, [redacted]

[redacted] during 1953-1955, it was determined that [redacted] was closely associated with PRIO and [redacted] registered under the Registration Act in connection with these activities.

b3
b6
b7C
b7E

T-1 said that information had come to his attention to the effect that CASTRO had been "passing the hat" around Miami, especially in factory neighborhoods where Cubans are employed, and that CASTRO had been soliciting this money for the alleged purpose of overthrowing BATISTA. T-1 said that CASTRO left Cuba, in about July, 1955, after having been released from prison under the new Amnesty Law, granting freedom to political prisoners.

He pointed out that CASTRO had led the attack against the Cuban military hospital barracks at Moncado, Santiago de Cuba, on July 26, 1953; that this attack resulted in the death of quite a few individuals on both sides and that as a result, CASTRO was tried, found guilty and sentenced to prison.

T-1 said that following his release from prison, FIDEL

[REDACTED]

b3
b7E

CASTRO remained in Cuba for about one month, during which time the Cuban Government granted him full freedom, after which CASTRO voluntarily departed from Mexico, where he remained for a while and then proceeded to New York City from Mexico.

T-1 said that CASTRO planned to hold a public meeting at the Flagler Theater, Miami, on November 20, 1955 and had been passing out leaflets, advertising this meeting. T-1 said that CASTRO had more or less been inviting his arrest by the police so that he would be a martyr in the eyes of his followers.

T-1 said that CASTRO claimed to lead an organization known as the PATRIOTIC CLUBS OF JULY 26; that he claimed to have a large following in Cuba and that he indicated he planned to organize chapters of this club in Miami and Tampa, and to have already organized such clubs in New York City and other places visited by him in the United States. T-1 said that actually, in his opinion, CASTRO does not represent any real following and that he merely represents himself. T-1 suspected that CASTRO was collecting funds for his own personal use.

T-1 said that CASTRO does have some following among members of one faction of the Orthodox Party of Cuba, among whom locally is [REDACTED]

b6
b7C

T-1 said that CASTRO is divorced from his wife, who is reportedly living in the Fort Lauderdale, Florida area. He said that his wife was [REDACTED]

[REDACTED] T-1 said that [REDACTED]
[REDACTED]

b6
b7C
b7D

The November 11, 1955 issue of the "Diario Las Americas", a Spanish language newspaper, Miami, carried an article entitled "FIDEL CASTRO WILL SPEAK AT THE FUNCTION AT THE FLAGLER THEATER ON THE 20TH", by JOSE FADUL. This article reported an interview of CASTRO, which is quoted in part as follows:



"From time immemorial and even at present the peoples of America have been faced with an unavoidable dilemma; the choice between constitutional laws and tyrannical arbitrariness; between AUTOCRATIC government and government created by the people and sustained by that free will of the citizen who has no despotic sponsors and who has his foundation in juridical institutions in which human right is not subservient to the will of an uncontrolled government. In what conditions do the various countries of America find themselves? This is an important question for free man! The answer is discouraging. However, it is a consolation to know that there are still men who are prepared to sacrifice all, their families, their tranquility and their lives, if necessary, for that famous LIBERTY which some have made the mistake of wanting to snatch from them." * * * * *

" * * * * * This is the fine city of Miami and this is the great country, the example of liberty and justice where all the persecuted come to enjoy their fraternal and sure shelter. It is delightful to see how human rights are respected. We will imitate the great people of the United States of America, the example of democracy and work in the world. We sincerely believe in their democratic ideal; it is for this reason that we come this far." * * * * *

" * * * * * The date of recovery has already been set. We shall fight without rest to achieve it in our country as well as outside. We shall go to every corner of the world; our ~~voice will be found wherever there is a Cuban.~~ This is not a political movement. This is a movement of all Cubans without distinction of political parties; of the Cubans who do not accept the condition of a government unable to make the Cuban people happy. Cuban patriotism does not need to be awakened and when duty calls, the answer is without conditions. The unification of all will be Cuba's salvation. Therefore, this general movement that gains its sustenance from the memory of the martyrs of July 26, 1953, cannot fail." * * * * *

The November 13, 1955 issue of the "Diario Las Americas" carried an article entitled "BATISTA WILL NOT BE ABLE TO SUPPORT THE PRESENT SITUATION, SAYS THE REVOLUTIONARY CASTRO", by RAMON COTO, of "Diario Las Americas".



This article announced a meeting to be held by CASTRO at the Flagler Theater November 20th.

The following quotations from CASTRO were extracted from this article:

"It is not possible for a country in which there are more than one and a half million people unemployed, in which the civil guarantees of the citizens are trampled upon daily, and the people humiliated and annoyed, to be able to support the Dictator BATISTA any longer. Unfortunately, this is the picture displayed by the Republic, that was founded by our apostle JOSE MARTI, for the good of all Cubans and not for a group of paid assassins to get in their hands, making their own the powers of the State, usurping the right of governing over the sovereign will of the people." * * * * *

"The purpose of our battle is not only to throw from power those who have no right to it, but also all the earlier evils which the Republic has suffered.

"It is now that the voice of the Cubans who have found it necessary to leave their country because of the economic situation existing in Cuba will become louder. The following are the real Cuban exiles: The economic exiles; those who are in the different cities of the United States at this time come to the number of tens of thousands, and the number will increase while BATISTA retains power. As in 68 and 95, these Cubans are prepared to cooperate for the definitive achievement of the ideals of the "July 26 Movement", because everybody wants to return to his country some day, when he can live in it honorably. More than 2,000 persons will aid by means of a small weekly allotment, in New York alone. In the way of encouraging information, we have the spontaneous offer of a sympathetic enthusiast who has donated for a period of six months a hall with a capacity for 300 couples, where dances will be held every Sunday for the benefit of the movement. Everything that is obtained through this will be used to augment the funds for fighting BATISTA as was done in the fight for Independence. I can assure you that the fight is now going on more forcefully than ever for the recon-

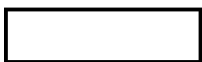

"quest of the public liberties and with all the moral strength that comes from the fact that it is directed by new men at the expense of the people, who as MARTI has said are the real leaders of revolutions." * * * * * "with much less than one-tenth of what was spent on those weapons, which never fired a shot, BATISTA could have been deposed."

"No, it is not true that we want revolution at any cost. BATISTA still has an opportunity to avoid one. Let him give up the presidency and hand the power over to Don COSME DE LA TORRIENTE, in order that general elections can then be held without BATISTA, let them pay close attention, without BATISTA!, because if he had any part in these elections, or should preside over them, then the formula would not have our support. We would accept that in order to avoid a civil war, but let it be understood that any form of support for those base politicians of such long standing who only aspire to the satisfaction of their ambitions will always be forcefully repulsed by us, because in the future that we have in mind for Cuba, they will be of no account." * * * * *

"The Cubans will give evidence of their rejection of the Batista Government by being present at the meeting at the Flagler Theater... We will await them there with the fervor and the patriotism that is characteristic of them!" * * * * *

The November 15, 1955 issue of the Miami Herald carried an article entitled "CUBAN REBEL SEEKS SUPPORT HERE TO OUST BATISTA", by GEORGE SOUTHWORTH, Herald Staff Writer, which reflected that CASTRO was in Miami making plans to topple the government of BATISTA. This article quoted CASTRO as follows, in part:

"We have an organized movement of 100,000 persons. If BATISTA continues to remain in power by force, then there is no other way but to throw him out by force.

"Dictator BATISTA has caused an economical crises in Cuba and the situation is becoming worse all the time. We have the only revolutionary movement that will face the regime."

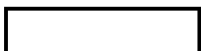

This article disclosed that CASTRO claimed that he and the people he is organizing in the United States are "staying within the laws of the United States." The article stated that CASTRO admitted that if his revolutionary movement should succeed, he does not know who would take over the presidency "but at least we would call immediate elections and live by the constitution."

On November 15, 1955 T-1 furnished a leaflet printed by the "Club Patriotico July 26 of Miami", which he said had been picked up on the street and turned over to him. This leaflet read in part as follows:

"CUBAN:

"BE PRESENT AT THE BIG PATRIOTIC MEETING WHICH THE CUBAN IMMIGRANTS OF MIAMI ARE ORGANIZING FOR SUNDAY, NOVEMBER 20, at 10:30 A. M. in the FLAGLER THEATER.

"With a fervor, impartiality, and purity of motives similar to 68 and 95, the sons of Cuba are preparing to bring liberty to their people.

"The thousands of countrymen who had to leave their country, persecuted by hunger and political oppression, are not surrendering their desire to return to it and live with honor, and liberty in the land in which they were born, where members of their families, their affections and their sentiments are to be found." * * * * *

"MARTI said that the only fixed soil in the universe is the soil on which one is born.

"However, to have a fatherland it must be won.

"No decent Cuban can remain detached from such a noble task. It is impossible for faith to falter. The great task of redeeming Cuba is today in the hands of new men, clean and without complicities or compromises with the past. That task is not now the work of a caudillo or of a party, but rather the ideal and the program of a people.

[redacted]

b3
b7E

"We want liberty, honor, and bread for all Cubans.

"The organization of the meeting will be in the hands of the fighters of Moncada, the young warrior, who is tireless, honest and honorable, and in whom the people of Cuba have placed their hopes.

"CUBAN:

"If Cuba pains you, if Cuba concerns you, if you love Cuba, do not fail to come to the FLAGLER THEATER on SUNDAY, NOVEMBER 20, at 10:30 A. M. This is no time for hesitation, no time for 'buts'. The Cuban is not a coward, the Cuban is not base, the Cuban has never been indifferent; the Cuban is rebellious, the Cuban is worthy, the Cuban is civically minded. His destiny cannot be frustrated; no one can ever take away his freedom and go unpunished. Such is the concept which the world should have of the Cuban. Let us once more demonstrate that it is so."

On November 20, 1955 SAs [redacted] and [redacted] attended an event at the Flagler Theater, identified as the "Club 26 de Julio de Miami" (July 26 Club of Miami). The theater was filled to near capacity by individuals of the Latin American race, and it would appear that a majority of them were Cubans.

b6
b7C

This event began at approximately 11:00 A. M. and broke up at approximately 2:30 P. M.

SA [redacted] observed the following:

b6
b7C

[redacted] was identified as [redacted] the aforementioned organization, with [redacted]

There were several speeches made prior to that of FIDEL CASTRO and those making same were identified as follows:

[redacted]

b6
b7C

[REDACTED]

b3
b7E

[REDACTED]

JUAN MANUEL MARQUEZ

[REDACTED]

b6
b7C

There was frequent applause during this act on the part of the audience. Shortly after the meeting began, a collection was taken from those who desired to contribute. It was noted that several hundred dollars appeared to have been collected.

At one point during the collection proceedings, [REDACTED] [REDACTED] in his speech, informed that the purpose of the collection was to fight the dictator under a plan to be determined and directed by FIDEL CASTRO.

b6
b7C

During the speech of JUAN MANUEL MARQUEZ, he asked the audience to bring about the defeat of BATISTA in 1956. He then asked the audience to stand and take an oath that they would support such a movement. The audience did swear to support such a movement.

All orators were in accord for BATISTA's abandoning the presidency and then permitting free elections without fear of official pressure.

FIDEL CASTRO thanked the audience for their fine spirit in support of funds which had been requested. He pointed out that this money would be used toward bringing about the defeat of BATISTA in 1956.

CASTRO was critical of certain of those individuals who had given large sums to purchase arms in furtherance of a revolutionary plot against BATISTA. He branded this money as "stolen" money and that he wanted no part of it.

CASTRO said he could not predict when he would return to Cuba in 1956, nor whether it would be with guns, or sufficient

[redacted]

b3
b7E

morale to defeat BATISTA.

CASTRO pointed out that 26,000 Cuban Nationals had come to this country from 1944 to 1952. From 1952 to present, an equivalent number had entered this country. It was CASTRO's plan or suggestion that each one of the incoming individuals entering from Cuba could be turned into a combatant to fight against BATISTA in support of the cause of liberty.

CASTRO related that Cuba would be free in 1956, or "we'll die".

On December 2, 1955 Miami Confidential Informant T-2, who has furnished reliable information in the past, reported substantially the same information concerning the November 20, 1955 meeting at the Flagler Theater. This Informant reported that CASTRO, at one point in his speech, stated very dramatically, "We would rather go to the revolution with 10 rifles bought with the money of the people than with 10,000 bought by the rich politicians. "

He also reported that [redacted] made a speech in which he condemned the American Ambassador to Cuba for giving a decoration to General TABERNILLA, the Chief of Staff of the Cuban Army. He also condemned the Government of the United States for furnishing planes, tanks and arms to the Cuban Government.

b6
b7C

T-2 said that FIDEL CASTRO advocated the overthrow of BATISTA by force unless BATISTA gives up soon and turns over the reigns of his government to TORRIENTE. He also reported that FIDEL stated that he needed money to buy arms but he avoided using the word revolution and he did not indicate where he intended to purchase these arms.

On November 28, 1955 T-1 furnished a number of photographs taken of individuals on the speaker's rostrum during the above described meeting at the Flagler Theater. In one of these photographs, he identified those present as:

1). [redacted]

b6
b7C

[redacted]

b3
b7E

[redacted]

b6
b7C

2). JUAN MANUEL MARQUEZ.

[redacted]

b6
b7C

4). FIDEL CASTRO.

[redacted]

b6
b7C

6). [redacted]

7). [redacted]

whom he described as being [redacted]

[redacted]

b6
b7C

Other photographs furnished by T-1 showed other poses of the above individuals on the stage at the Theater. Another photograph showed what appears to be several hundred people seated in the audience. T-1 said that most of the people who attended this meeting were Cubans, Puerto Ricans and Dominicans.

The November 22, 1955 issue of the Miami Herald carried an article entitled "FOES DEFIED BY BATISTA". This article disclosed that BATISTA stated that he would remain in office until his term expires in 1958, despite threats and demands from his opposition that he resign. [redacted] a spokesman for BATISTA, ridiculed a threat by FIDEL CASTRO to overthrow the government of BATISTA if he refuses to resign.

b6
b7C

On November 23, 1955 [redacted] Investigator, Immigration and Naturalization Service, Miami, advised that FIDEL ALEJANDRO CASTRO RUZ had come into the INS office, at which time he was interrogated concerning his status as an alien.

[redacted]

b3
b7E

[redacted] advised that CASTRO stated he was then residing at 624 S. W. 14th Avenue, Miami; that he was born August 13, 1926 at Incueto, Oriente, Cuba, and last entered the United States at San Antonio, Texas, October 20, 1955 as a B-2 visitor to November 19, 1955, destined to [redacted] Care of [redacted] [redacted] said that according to CASTRO's papers, he was accompanied by [redacted] who was destined to [redacted]

b6
b7C

[redacted] said that CASTRO's papers reflected that he had made application for an extension at New York on October 31, 1955, but that his application was denied and he was granted until December 10, 1955 in which to depart.

b6
b7C

CASTRO exhibited to INS his passport, No. 17702, issued June 23, 1955, valid for 5 years. This passport contained a Non-immigrant Visa B-2, No. V-1200944, issued at the American Embassy in Mexico City, Mexico, October 4, 1955, and valid for a single admission.

CASTRO told INS that his purpose in coming to the United States on October 20, 1955 was to visit his son, and at the same time, to comply with invitations which Cubans in New York, Miami, Tampa and Key West had made, for the purpose of explaining the situation in Cuba and his ideas and plans as leader of the MOVEMENT OF THE 26TH OF JULY, 1953.

CASTRO described this as a movement to "fight today against the dictatorship of BATISTA in Cuba, recovering the fallen morale, maintaining the recovery, to accept moral aid and economic aid which they have suffered from lack of."

[redacted] said that CASTRO stated that he was the Chief of the MOVEMENT OF THE 26TH OF JULY, 1953. CASTRO said that on July 26th, 16 months after BATISTA took over the government of Cuba, a group of Democratic youths initiated an armed movement to recover the liberties which had been taken away from the people, and on that occasion their action was not successful and BATISTA ordered the assassination of 80 young prisoners, who today are martyrs and for that reason, members of the organization called the MOVEMENT OF JULY 26TH, 1953.

b6
b7C

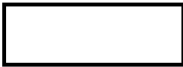

b3
b7E

CASTRO claimed to be the elected representative of that group. He said that the other officers are in Cuba and he declined to give their names on the grounds that they would be persecuted if their identities were known in Cuba.

When questioned concerning the aims and purposes of this movement, CASTRO stated that the purpose was to remove the government which tyrannizes the people, recover the liberty of the people and the democratic system which was taken away by BATISTA.

CASTRO related that after the attack on the fort at Moncada failed, he, along with others, were taken prisoner and many killed, although he, himself, was spared and in the month of May, 1955, was liberated when the Cuban Government declared political amnesty in order to quiet the people. He stated that he remained in Cuba for approximately 7 weeks after he was released before he had to leave Cuba for Mexico. He said that the Cuban Government canceled the radio programs on which he had been appearing to tell his story. He claimed that he cannot now return to Cuba.

When questioned as to whether or not his MOVEMENT OF JULY 26TH was connected with any other political organization, he answered that it is connected with the Orthodox Party of Mr. EDWARD CHIVAS, now deceased, but whose brother is the present president.

When questioned as to whether or not the MOVEMENT OF JULY 26TH has a branch organization in Miami, CASTRO replied that it had a large patriotic group whose officers are:



b6
b7C

. CASTRO said that the Miami organization of this movement is a public club, not secret, and is going to have 2,000 members.

When questioned as to his activities since last entering the United States, CASTRO said that he visited Cuban groups

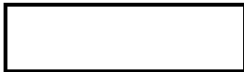

b3
b7E

upon invitation to give two public talks and had given statements to the press. When questioned as to how his group proposed to overthrow the Government of BATISTA, CASTRO stated that he wanted to do this through Cuban public opinion and through having other American countries to renounce BATISTA and have the power of the government turned over to Colonel DON COSME DE LA TORRIENTE, a Veteran of the War of Independence, so that he could preside over an honest election.

When questioned if he intended to overthrow BATISTA by force, CASTRO replied in the negative, stating that he intended to overthrow it first through pressure of public opinion, but "if BATISTA refuses to turn back the rights to the people of Cuba, we will have to exercise the right which all the oppressed people of the world have used to recover their liberty. If BATISTA does not give up, then the people of Cuba will have a revolution in which event we will be with the people. If BATISTA does not give up to the pressure of public opinion, I do not deny that we will have to use some force, but actually we are not using force nor advocating the use of force at this time."

CASTRO disclosed that other speakers at the Flagler Theater in addition to himself included

b6
b7C

JUAN MANUEL MARQUEZ, and others whose names he was unable to recall.

He said that none of these individuals advocated in their speeches the armed overthrow of the Cuban Government, but that they had said, as did he, himself, that "we had to utilize civic forces before using revolutionary force." He said that the monies collected were to be used for publicity purposes and the general fight.

He claimed that some of this money had been sent to Cuban exiles in Mexico, and he denied that he was purchasing any arms for use in Cuba. He claimed that he has remained within the law in the United States, that he planned on giving talks in Tampa and Key West. While in Tampa, he said that he could be reached at the home of

b6
b7C

[REDACTED]

b3
b7E

He claimed that he had never been a member of any organization affiliated with the Communist Party.

[REDACTED] said that CASTRO also claimed that he would leave the United States by December 10, 1955.

b6
b7C

AT TAMPA, FLORIDA

On November 23, 1955 Miami Informant T-1 advised that CASTRO was leaving Miami the following day for Tampa and would be accompanied by JUAN MANUEL MARQUEZ. [REDACTED]

b6
b7C

T-1 furnished a one-page leaflet in the Spanish language, announcing a meeting to be held at the Italian Union Theater in Tampa, on November 27, by the PATRIOTIC CLUB OF JULY 26 OF TAMPA. In this leaflet CASTRO was described as "the leader of the Cuban revolution".

On November 27, 1955 T-1 reported that the following individuals accompanied CASTRO to Tampa:

[REDACTED]

b6
b7C

T-1 said that he had received information to the effect that [REDACTED]

b7D

The November 27, 1955 issue of the "Tampa Tribune, carried an article entitled "ITALIAN CLUB BARS THEATER TO LEADER

[redacted]

b3
b7E

OF CUBAN REVOLT", which reflected that the scheduled meeting of CASTRO's group had been canceled by the Italian Club because the meeting was political in nature.

This article quoted CASTRO as stating, upon being interviewed, "I cannot say I will buy arms with it. All I can say is that it will be used to help the movement. What do you want me to say?", in referring to money collected during an afternoon meeting in Tampa.

The November 26, 1955 issue of the "Tampa Tribune" carried an article entitled "ANTI-BATISTA CUBAN COMES HERE TO SEEK REVOLT FUNDS", by TOM O'CONNOR, Staff Writer, who stated that CASTRO had come to Tampa under the auspices of a recently formed society in Tampa, known as the 26 JULY CLUB, provisionally headed by VICTORIANO MANTEIGA, publisher of a Spanish language newspaper. CASTRO was quoted as stating, "We will try every legal means to oust the tyrant BATISTA from Cuba, but failing in that we will take to arms."

The Tampa meeting was held at 3:00 PM on Sunday, November 27, 1955, at the CIO Hall, 1226 - 7th Avenue, Tampa. SAs [redacted] and [redacted] who were present, noted that several announcements were made, prior to the speeches, by [redacted] described as [redacted] of the PATRIOTIC CLUB OF JULY 26 OF MIAMI. [redacted] referred to CASTRO as "the leader of the Cuban revolution".

b6
b7C

As soon as CASTRO arrived, the meeting was begun with the playing of a recording of the "Star Spangled Banner", followed by a recording of the Cuban National Anthem. [redacted] and [redacted] of Miami, were the first speakers. Third speaker was [redacted] of Tampa, [redacted] and introduced as [redacted] of the PATRIOTIC CLUB OF JULY 26 OF TAMPA. Nothing significant was said in these speeches.

b6
b7C

JUAN MANUEL MARQUEZ, the fourth speaker, was described as a companion of FIDEL CASTRO for many years. He compared FIDEL CASTRO with the Cuban Hero, JOSE MARTI. He praised CASTRO for his devotion to the cause of liberty and asked for contributions





b3
b7E

to further their cause. In doing this, he stated, "There is no use in equivocating. The money is needed to buy rifles to overthrow the dictatorship of BATISTA." This statement was greeted by applause and shouts from the audience. A collection was then taken up.

The final speaker was FIDEL CASTRO. He discussed conditions in Cuba, alleging abuses by the present authorities against businessmen and all citizens. He declared that it is the duty of every Cuban who loves liberty to take up the fight against the dictatorship of Cuba or, if he cannot take part in this fight, then to at least support it. CASTRO said that he had not come to solicit help or contributions from American citizens, but only from Cubans living in exile.

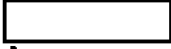
He pledged that, "Our movement will end only when tyranny has ended or when we die.". He said that his present purpose is peaceful and that he and his associates have done nothing to violate the laws of the United States, for which they have respect. He said their purpose is to compel BATISTA to resign and call elections; that BATISTA could in this way avoid any bloodshed. He said that if BATISTA did not resign, then revolution would be the only course left for them to follow.

Agents  and  estimated that this meeting was attended by approximately 150 to 200 individuals.

b6
b7C

Miami Confidential Informant T-3, who has furnished reliable information in the past, reported on November 28, 1955



b6
b7C
b7D

SA  obtained one copy of a pamphlet consisting of 28 pages, entitled "LA HISTORIA ME ABSOLVERA", by Dr. FIDEL CASTRO. This pamphlet, which is in the Spanish language, is being transmitted to the Bureau as an enclosure of this report.

b6
b7C

CASTRO announced at the Tampa meeting that he intended to hold a similar meeting in Key West on December 2, 1955; that he would return from Tampa to Miami on November 28, 1955 and proceed from Miami to Key West.

[REDACTED]

b3
b7E

On November 29, 1955 T-1 advised that FIDEL CASTRO and his immediate associates returned from Tampa to Miami. [REDACTED]

[REDACTED]

b6
b7C
b7D

T-1 said that [REDACTED]

[REDACTED]

b6
b7C
b7D

T-1 said that [REDACTED]

[REDACTED]

AT KEY WEST, FLORIDA

Miami Informant T-2 reported that FIDEL CASTRO and several of his associates were in Key West on December 2, 1955 for the alleged purpose of holding a meeting. T-2 learned that this meeting was held at an unidentified private home; that less than 100 persons were present, and that a disappointing collection had been taken.

T-2 reported on December 9, 1955 that FIDEL CASTRO succeeded in holding a public meeting in the parking lot of a dog track, outside the City Limits of Key West, after having been refused permission to hold a similar meeting at the Key West Elks Club. T-2 obtained in Key West a leaflet in the Spanish language announcing the meeting to be held at 8:30 PM, December 7, 1955, at the Elks Club in Key West. This meeting announced the speaker as Dr. FIDEL CASTRO.

[redacted]

b3
b7E

T-2, who was present at the meeting at the dog track, stated that [redacted] was the first speaker who introduced some of the others present. JUAN MANUEL MARQUEZ then spoke, complaining that local Cuban officials had used influence in order to prevent the meeting from taking place at the Elks Club.

b6
b7C

FIDEL CASTRO then spoke, telling his audience about the trouble he had encountered while in the United States in attempting to hold the meetings. He took up a collection and stated the funds were to be used to help finance his movement. He made no mention of guns or of revolution. He said that he was winding up 7 weeks of campaigning and that "We are leaving for other lands where we are being awaited."

T-2 said that the meeting was attended only by about 120 persons and that CASTRO seemed to be disappointed and was not as vigorous or aggressive as he had been at the Flagler Theater meeting in Miami.

T-1 said that members of CASTRO's group also sold copies of the pamphlet entitled "LA HISTORIA ME ABSOLVERA", by Dr. FIDEL CASTRO, one copy of which T-2 obtained and furnished the Miami Office.

The December 9, 1955 issue of the "Key West Citizen", carried an article entitled "ALLEGED CUBAN PLOTTER SPEAKS HERE WEDNESDAY". This article disclosed that FIDEL CASTRO had held an unpublicized meeting Wednesday night outside the City Limits.

This article disclosed that the Elks Club had canceled arrangements made by CASTRO to hold a meeting there when they became aware of the publicity which had attended CASTRO's meetings held elsewhere.

AT MIAMI, FLORIDA

[redacted] Investigator, INS, Miami, advised on December 10, 1955 that FIDEL CASTRO, accompanied by [redacted] a naturalized citizen, departed Miami at 7:45 PM on Flight 101, Guest Airlines, for Mexico City. [redacted]

b6
b7C

[redacted]

b3
b7E

said that CASTRO indicated that he hopes to return to the United States. [redacted] said that there were about 20 people at the Miami International Airport to bid CASTRO farewell.

b6
b7C

On December 13, 1955 Miami Informant T-1 advised that

[redacted]

b6
b7C
b7D

On December 9, 1955 T-2 reported that [redacted] mailing cards to several hundred people in Miami announcing a meeting to take place December 10, 1955 at 3527 N. W. 2nd Street, Miami, under the auspices of the PATRIOTIC CLUB OF JULY 26 OF MIAMI. T-2 learned [redacted] that members of this club are expected to pay dues of \$1.00 per week.

b6
b7C
b7D

Informant noted that receipts are signed by FIDEL CASTRO as President. [redacted]

[redacted]

b6
b7C

[redacted] advised that INS, Miami, possessed no record on JUAN MANUEL MARQUEZ.

- P -

ENCLOSURE TO BUREAU: 1 pamphlet entitled "LA HISTORIA ME ABSOLVERA"

[redacted]

b3
b7E

ADMINISTRATIVE

Information of interest to United States Customs, Miami, as contained in this report, was furnished currently by SA [redacted] to [redacted] Supervising Customs Agent.

b6
b7C

T-1 has advised that he has reported all information of interest to United States Customs directly to [redacted]

INFORMANTS

T-1 is [redacted] who was contacted 11/15, 23, 28; 12/13/55, who reported orally to SA [redacted] instant case.

b6
b7C
b7D

T-2 is [redacted] who reported orally on 11/21, 23; 12/5/55, and who submitted written reports on 12/6, 9/55 to SA [redacted] and instant case.

T-3 is [redacted] (Confidential Source), who reported orally on 11/28/55 to SA [redacted] at Tampa, Florida, instant case.

b6
b7C
b7D

LEADS

WASHINGTON

AT WASHINGTON, D. C.

Will check central records, INS, for pertinent information concerning JUAN MANUEL MARQUEZ and associates of FIDEL CASTRO. MARQUEZ is believed to be currently residing in Miami.

ADMINISTRATIVE PAGE



LEADS (Continued)

MIAMI

AT MIAMI, FLORIDA

Will conduct appropriate investigation to determine if the Miami and Tampa chapters of this organization are active and whether or not officers or members are acting in violation of the Registration Act.

REFERENCES

Bureau airtel to New York City, 11/23/55.
Bureau letter to New York City, 12/2/55.
Bureau letter to Miami, 12/7/55.
Miami airtel to Bureau 11/18, and 28/55.
Miami teletype to Bureau, 12/10/55.

ADMINISTRATIVE PAGE (Cont'd.)

(Title) FIDEL ALEJANDRO CASTRO RUZ

(File No.) [redacted]

1. Photos of Fidel Alejandro Castro Ruz. (Filed 2/27/56) pgd.

2. Photo of MARIE MARQUEZ RODRIGUEZ (filed 5-9-56) [redacted]

3. 2 photos of [redacted] (filed 4/15/59) [redacted]

4. 2 photos of [redacted] (filed 4/15/59) [redacted]

5. Photostat of lit. envelope to: [redacted] from [redacted] (filed 5-22-59) [redacted]

b3
b6
b7C
b7E

**DO NOT DESTROY; HISTORICAL
VALUE, NATIONAL ARCHIVES**

Disposition:

3. 1 photo to M.P.D. 4-16-59 [redacted]

4. 1 photo to M.P.D. 4-16-59 [redacted]

b6
b7C

**DO NOT DESTROY; HISTORICAL
VALUE, NATIONAL ARCHIVES**

[redacted]	
SEARCHED [redacted]	INDEXED [redacted]
SERIALIZED [redacted]	FILED [redacted]
FEB 27 1956	
FBI - WASHINGTON	
[redacted]	

b3
b6
b7C
b7E

File No.

[Redacted]

b3
b7E

Date Received 2-7-56

From

The N.Y. office

(Name of Contributor)

New York. Let dated 2/3/56

(Address of Contributor)

By

[Redacted]

b6
b7C

(Name of Special Agent)

To Be Returned

Yes ()

No (x)

Description:

photos of Fidel
Alejandro Castro Rey.



FIDEL ALEJANDRO CASTRO RUZ
wa: Fidel Castro Ruz
6 ft.
Hair, bronw, eyes, brown
Race: White
DOB: Aug. 13, 1926
POB: Cueto, Oriente, Cuba

Fidel Alejandro Castro Ruz

b3
b7E

File No.

[Redacted]

b3
b7E

Date Received 4-12-56

From Havana Club

(Name of Contributor)

see entry SA

dated 3/27/56 at Havana

(Address of Contributor)

b6
b7C

By

(Name of Special Agent)

To Be Returned

Yes ()

No (X)

Description:

photo of Manuel Marquez
Rodriguez



MANUEL MARQUEZ RODRIGUEZ
(Dec 29, 1953)



b3
b7E

File No.

[Redacted]

b3
b7E

Date Received

4/15/59

From

Bureau

(Name of Contributor)

W.D.C.

(Address of Contributor)

By

Sa.

[Redacted]

Agent)

b6
b7C

To Be Returned

Yes ()

No (✓)

Description:

2 photos of

[Redacted]

[Redacted]

b6
b7C



b6

b7C

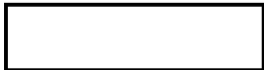

b3

b7E

File No.

[Redacted]

b3
b7E

Date Received

4/15/59

From

Bureau

(Name of Contributor)

W.D.C.

(Address of Contributor)

By

S.A.

[Redacted]

(Agent)

b6
b7C

To Be Returned

Yes ()
No ()

Description:

2 photos of

[Redacted]

[Redacted]

b6
b7C



b6
b7C



b3
b7E

File No.

[Redacted]

b3
b7E

Date Received

4/17/59

From

New York Office
(Name of Contributor)

N.Y.

(Address of Contributor)

By SA -

[Redacted]

Agent)

b6
b7C

To Be Returned

Yes ()
No (X)

Description:

*Photostats of letter
and envelope address
to*

[Redacted]

[Redacted]

[Redacted] *from* [Redacted]

[Redacted]

[Redacted]

b6
b7C

AFTER FIVE DAYS. RETURN TO

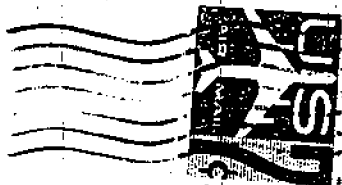

●●● VIA AIR MAIL

b6
b7C

[redacted]

[redacted]

4/6/59

[redacted]

yo si ordena
ria no tres pesos asta cien
por la Cabeza de ese
Carnisero y Comunistas y
Criminal Costio. Parues.
mentira que un diario tan
cultura y tan social y
democratico mensione el nombre
de un herode y traedor.

Atte

[redacted]

yo me alegro que Fidel Costio
venga a estado unidos
porque no va a salir de aqui
y no matara mas gente en
Cuba.

b3
b6
b7C
b7E

b6
b7C

DIRECTOR, FBI [redacted]

1/26/56

SAC, WFO [redacted]

FIDEL ALEJANDRO CASTRO RUZ, wa.
Juan Manuel Marquez

[redacted]

Reference is made to the report of SA [redacted] dated 1/4/56, at Miami, Fla. which contains a lead for the WFO to check Central Office records, INS for pertinent information concerning "JUAN MANUEL MARQUEZ and associates of FIDEL CASTRO". The lead does not reflect who the associates of CASTRO are or about whom, besides MARQUEZ, the Miami Division wants INS information.

It appears to the WFO that Miami intended for the lead to read "JUAN MANUEL MARQUEZ, an associate of FIDEL CASTRO", and this office is checking INS files for the name of MARQUEZ only unless Miami indicates which other names should be checked.

It is noted that in checking INS files on Latin American names, some background information is necessary in order to identify the files with the person in whom this Bureau is interested. If Miami desires that additional names in referenced report be checked, it is suggested that some background information be obtained regarding them. P.

- 2 - Bureau
- 1 - Miami [redacted] (Info) (RM)
- 1 - WFO [redacted]

(4)

[redacted]

(P) [redacted]

✓ [redacted]

Searched
Serialized
Indexed
Filed

[redacted]

[redacted]

b3
b7E

b6
b7C

b3
b6
b7
b7

b3
b6
b7C
b7E

Date: 2/3/56

To: DIRECTOR, FBI [redacted]
 From: SAC, NEW YORK [redacted]
 Subject: FIDEL ALLJANDRO/CASTRO ROZ, was;
 JUAN NATUEL MARQUEZ

b3
b7E

[redacted]

OO: NY

Relet to Assistant Attorney General [redacted]
 from the Director dated 1/4/56.

b6
b7C

On 12/20/55 [redacted] Assistant Attorney General, Internal Security Division, Department of Justice, advised the Director that subject, CASTRO, as chief of an organization known as the "26th of July Group", organized in Cuba, is under an obligation to register with the Attorney General under the terms of the Foreign Agents Registration Act. [redacted] requested that an address be supplied where a letter soliciting CASTRO's registration could be addressed to him.

b6
b7C

CASTRO was the leader of the revolutionary attack on the Moncada Barracks at Santiago de Cuba on July 26, 1953. He was imprisoned by the Cuban authorities as a result of this, but in May, 1955, he was released under a General Amnesty Law. In July, 1955, he traveled to Mexico.

- 2 - Bureau [redacted] (Encs. 2) (RM)
- 2 - Albuquerque (Encs. 2) (RM)
- 2 - El Paso (Encs. 2) (RM)
- 2 - Houston (Encs. 2) (RM)
- 2 - Los Angeles (Encs. 2) (RM)
- 2 - Miami [redacted] (Encs. 2) (RM)
- 2 - Mobile (Encs. 2) (RM)
- 2 - New Orleans (Encs. 2) (RM)
- 2 - Phoenix (Encs. 2) (RM)
- 2 - San Antonio (Encs. 2) (RM)
- 2 - San Diego (Encs. 2) (RM)
- ② - Washington Field (Encs. 2) (RM)
- 1 - New York [redacted]

b3
b6
b7C
b7E

[redacted]

(25)

[redacted]

SEARCHED	INDEXED
SERIALIZED	FILED
FEB 7 1956	
FBI - WASHINGTON	

b3
b6
b7C
b7E

handle pronto

Letter to Director
[REDACTED]

b3
b7E

On October 20, 1955, he entered the US at San Antonio, Texas. CASTRO subsequently addressed meetings of Cuban emigrants in NY and at Miami, Florida, and vicinity, where he advocated the violent overthrow of the government of President FULGENCIO BATISTA of Cuba and solicited funds for this purpose. In each community which he visited he attempted to organize a group using the name "Patriotic Clubs of July 26", "July 26th Club of New York", or similar titles. CASTRO departed from Miami, Florida, on December 10, 1955, by Guest Airlines destined for Mexico City.

The WFO is requested to place stop notices with the Customs Service and the Immigration and Naturalization Service at Washington, D. C., so that the Bureau will be notified immediately if CASTRO attempts to enter the US again. No process is outstanding for CASTRO for any violation within the jurisdiction of the FBI, and it is not desired that he be detained in any manner or made aware that the FBI is interested in him.

All offices receiving copies of this letter are requested to immediately notify the Bureau and the NYO by teletype if any information is received indicating CASTRO has entered the US. With the exception of obtaining all available information from the reporting agency relative to CASTRO's itinerary and destination in the US, no further action should be taken.

A description of CASTRO follows:

Name	FIDEL ALEJANDRO CASTRO RUZ wa; Fidel Castro Ruz
Height	6 feet
Hair	Brown
Eyes	Brown
Race	White
Complexion	Fair
Nationality	Cuban
Marital status	Divorced

Letter to Director

[REDACTED]

b3
b7E

Date of birth	August 13, 1926
Place of birth	Cueto, Oriente, Cuba
Occupation	Lawyer
Residences	Calle 23 #1511 or #1352-33 Havana, Cuba Hotel Tivoli Mexico City, Mexico

[REDACTED]

[REDACTED]

Cuban Passport No. 17702 issued at Havana,
Cuba, 6/23/55

b6
b7C

Two copies of a photograph ^{of CASTRO} are enclosed for the Bureau and all offices receiving copies of this letter. This photograph was obtained from the front page of a booklet entitled, "La Historia Me Absolvera", which was reportedly written by CASTRO and printed on October 30, 1955.

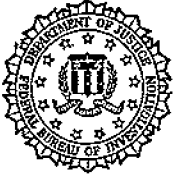

UNITED STATES DEPARTMENT OF JUSTICE
FEDERAL BUREAU OF INVESTIGATION

WASHINGTON 25, D. C.

In Reply, Please Refer to
File No.

February 20, 1956

TO: ALL COLLECTORS OF CUSTOMS
SUBJECT: FIDEL ALEJANDRO CASTRO RUZ, with alias Fidel Castro

The Federal Bureau of Investigation, U. S. Department of Justice, is interested in FIDEL ALEJANDRO CASTRO RUZ, a Cuban citizen who may attempt to enter the United States. FIDEL ALEJANDRO CASTRO RUZ is believed to presently reside at Calle 23 #1511 or 1352-33, Havana, Cuba, and is described as follows:

Born: 8/13/26, Cueto, Oriente, Cuba
Race: White
Height: 6'
Eyes: Brown
Complexion: Fair
Hair: Brown
Occupation: Lawyer
Marital Status: Divorced

FIDEL ALEJANDRO CASTRO RUZ was issued Passport Number 17702 on June 23, 1955, at Havana, Cuba. He has also resided at Tivoli Hotel, Mexico City, Mexico, and with [redacted]

b6
b7c

In the event this individual attempts to enter a port in your district, it would be appreciated if you would notify by telephone, collect if necessary, the nearest office of the Federal Bureau of Investigation, and at the same time advise that office that the New York Division of the Federal Bureau of Investigation is particularly interested in CASTRO.

In no event should this individual be detained or otherwise made aware that the Federal Bureau of Investigation is interested in him.

Very truly yours,

L. L. LAUGHLIN
Special Agent in Charge

b3
b6
b7c
b7E

Searched _____
Serialized
Indexed _____
Filed

[redacted]

1cc - New York
1cc - Customs

Sent to all Collectors of Customs
2-20-56

Washington Field Office, Room 506
Old Post Office Building

b3
b7E

February 15, 1956

Washington 25, D. C.

[Redacted]
Acting Assistant Commissioner
Inspections and Examinations Division
Immigration and Naturalization Service
U. S. Department of Justice
Washington 25, D. C.

b6
b7C

Attention: Control Section

Re: Fidel Alejandro Castro Ruz, with
alias, Fidel Castro

Dear Sir:

It is respectfully requested that a lookout
notice be placed in your file and at all ports of entry
on Fidel Alejandro Castro Ruz, with alias Fidel Castro.
He is described as follows:

Date of Birth:	August 13, 1926
Place of Birth:	Cueto, Oriente, Cuba
Height:	6'
Hair:	Brown
Eyes:	Brown
Race:	White
Complexion:	Fair
Nationality:	Cuban
Occupation:	Lawyer
Residences:	Calle 23 #1511 or 1352-33, Havana, Cuba; Hotel Tivoli, Mexico City, Mexico;

Passport:

[Redacted]
Cuban Passport #17702 issued at
Havana, Cuba, 6/23/55

2-INS

1-New York [Redacted] (Info) (RM) (When this lookout and/or stop
notice has served its purpose, it should be withdrawn by
your office directly by letter to INS. No stop card is
maintained in WFO files.)

b3
b6
b7C
b7E

2-WFO

(1-66-1922)

[Redacted]
(5)

[Redacted]

[Redacted]

Searched

Serialized [Redacted]

Indexed [Redacted]

Filed [Redacted]

[Redacted]

[Redacted]

In the event that this individual attempts to enter or depart from a port in your district, it would be appreciated if you would notify by telephone, collect if necessary, the nearest office of the Federal Bureau of Investigation, and at the same time advise that office that the New York Division of the Federal Bureau of Investigation is particularly interested in Castro.

Castro should not be detained or otherwise made aware that the Federal Bureau of Investigation is interested in him.

Your cooperation is very much appreciated.

Very truly yours,

L. L. LAUGHLIN
Special Agent in Charge

DIRECTOR, FBI [redacted]

2/15/56

SAC, WFO [redacted]

b3
b7E

FIDEL ALEJANDRO CASTRO RUZ, wa., et al

[redacted]

(OO: NEW YORK)

ReNYlet 2/3/56 requesting stop notices be placed with INS and Customs.

The requested stop notices were placed with All Collectors of Customs and with the Central Office of INS for all ports of entry by letter dated 2/15/56.

The New York Division will advise the WFO when it is desired that these stop notices be removed. P.

2-Bureau
2-New York [redacted] (RM)
①-WFO

b3
b6
b7C
b7E

[redacted]
[redacted]
(5) [redacted]

[redacted]

✓ [redacted]

[redacted]

b3
b6
b7C
b7E

Searched _____
Serialized [redacted]
Indexed _____
Filed [redacted]

~~CONFIDENTIAL~~

b6
b7c

FD-72
(6-10-53)

FEDERAL BUREAU OF INVESTIGATION

FORM No. 1 BUREAU
THIS CASE ORIGINATED AT

REPORT MADE AT MEXICO, D. F.	DATE WHEN MADE 2/10/56	PERIOD FOR WHICH MADE 12/7,16,23/55 1/18,23/56	REPORT MADE BY [redacted]
TITLE FIDEL ALEJANDRO CASTRO RUZ, wa. Fidel Castro Ruz; JUAN MANUEL MARQUEZ		CHARACTER OF CASE [redacted]	

b3
b6
b7c
b7E

SYNOPSIS OF FACTS:

Subject FIDEL ALEJANDRO CASTRO RUZ reportedly resides in Mexico City at unknown address, but takes meals and makes contacts at [redacted] which is the residence of [redacted]. In December, 1955, he published a "Manifiesto No. 2" in the name of the "National Directorate of the July 26 Revolutionary Movement" which allegedly was being sent to Cuba for printing and dissemination. Unconfirmed information received that he was joined recently in Mexico City by his colleague, JUAN MANUEL MARQUEZ. Subject reported [redacted]

b6
b7c

b7D

-P-

APPROVED AND FORWARDED: [redacted]	SPECIAL AGENT IN CHARGE [redacted]	DO NOT WRITE IN THESE SPACES	
COPIES OF THIS REPORT 14 - Bureau [redacted] 1 - American Embassy [redacted] (circulation) 1 - Mexico City [redacted]		SEARCHED [redacted] INDEXED [redacted] SERIALIZED [redacted] FILED [redacted] MAR 13 1956 FBI - WASHINGTON	[Handwritten initials]

b3
b6
b7c
b7E

PROPERTY OF FBI—This confidential report and its contents are loaned to you by the FBI and are not to be distributed outside of agency to which loaned.

UNITED STATES DEPARTMENT OF JUSTICE
FEDERAL BUREAU OF INVESTIGATION

In Reply, Please Refer to
File No.

Washington 25, D. C.

February 10, 1956

~~CONFIDENTIAL~~

RE: FIDEL ALEJANDRO CASTRO RUZ,
wa. Fidel Castro Ruz;
JUAN MANUEL MARQUEZ

I. BACKGROUND DATA -
FIDEL ALEJANDRO CASTRO RUZ

A. Residence

T-1, who has furnished reliable information in the past, advised that FIDEL ALEJANDRO CASTRO RUZ was in Mexico City as of the middle of December, 1955, and had been seen in Mexico City from time to time thereafter up to and including February 3, 1956. T-1 was unable to furnish subject's residence address in Mexico City, but stated he has been taking most of his meals and making contacts at [redacted]

[redacted] T-1 stated [redacted]

b6
b7C
b7D

[redacted] T-1

B. Employment

T-1 advised that the subject is not employed in Mexico, but that he is spending his entire time in connection with his efforts to organize a revolutionary movement against the present Cuban Government.

T-2, who has furnished reliable information in the past, advised that [redacted]

b7D

C. Information [redacted]

T-2 advised that the following information concerning subject [redacted]

b7D

~~CONFIDENTIAL~~

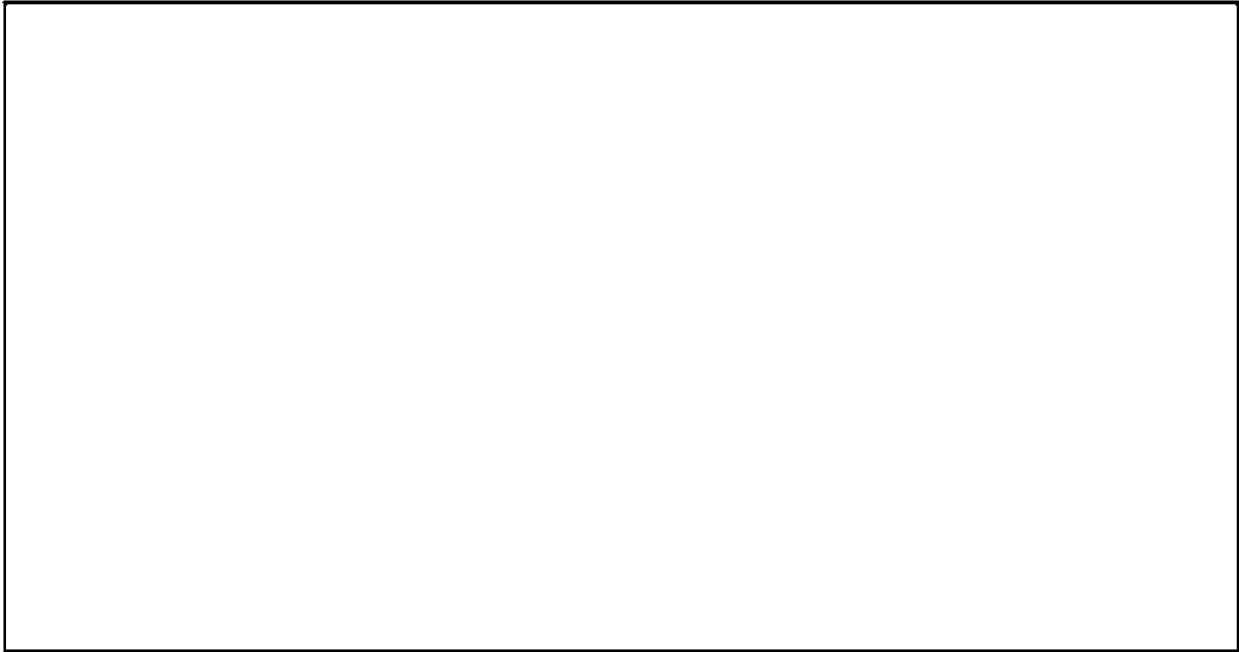

b6
b7C
b7D

II. ACTIVITIES -
FIDEL ALEJANDRO CASTRO RUZ



b7D

B. Revolutionary Activities

T-1 advised that

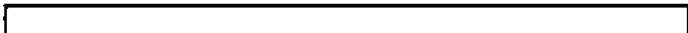

b7D

This pamphlet was entitled "Manifiesto No. 2 of the July 26 (group) to the People of Cuba" and was signed by

FIDEL CASTRO "in the name of the National Directorate of the July 26 Revolutionary Movement." The leaflet also stated it was "signed on the island of Nassau on December 10, 1955," but, according to T-1, [REDACTED]

b7D

C. Translation of Manifiesto

There follows hereinunder a translation from Spanish of the "Manifiesto No. 2" described above:

"IN ALL HONORABLE HEARTS WE SHALL FIND MAGNANIMOUS SUPPORT. AND WE SHALL KNOCK AT ALL DOORS. AND WE SHALL SOLICIT CONTRIBUTIONS FROM TOWN TO TOWN. AND THEY WILL BE GIVEN TO US BECAUSE WE SHALL ASK WITH HONOR."

JOSE MARTI

I direct these lines fundamentally to the generous men and women of my country. In my mind's eye I can still see the unforgettable scenes which I have experienced among the Cuban immigration in the United States. Standing with their hands raised those Cubans, wherever we went, swore that they would not rest until their land was redeemed, and they came forward en masse to deposit in the straw hat the product of their sweat which here is spent in hard work. But that was not to be their only contribution. It is not necessary to seek out the Cuban emigrants requesting their aid; following each public meeting they are seen in the streets asking the location of the PATRIOTIC CLUB in order to petition their registration and offer their weekly contribution; every Sunday they will organize Cuban festivities in order to deliver everything that is collected for the revolution: the first of those, which took place a few days ago in New York, gave a balance of hundreds of pesos. All of the beautiful of our historic tradition has been born again in the Cuban emigration with indescribable fervor. The PATRIOTIC CLUBS of Bridgeport, Union City, New York, Miami, Tampa, and Key West are organized. New nuclei will be organized in Chicago, Philadelphia, Washington, and other places where Cubans reside who have had to abandon their native land. Seven weeks of untiring effort, dedicated to the organization of Cubans, from the Canadian frontier to the glorious Keys, have rendered the best possible fruits.

The JULY 26, which unites and organizes all of the revolutionary elements of the country in a tightly knit and disciplined movement, departing from the traditional borders in which thus far the miserable Cuban politics have operated, has called to the struggle on an equal basis our brothers of the emigration who also are Cubans who suffer the misfortunes of Cuba, and the emigration has responded unanimously in connection with the JULY 26. The emigration offers hundreds of young combatants, many of them veterans of the European and Pacific fronts of the second world war, who now wish to fight for the cause of liberty in their own land and besides offer abundant economic resources in order that those generous and virile arms will not go unarmed in confronting tyranny again with the cry of liberty or death on their lips.

Some do not fully understand the meaning of the public pronouncement of a revolutionary idea and they ask if that does not place the oppression on guard. They forget many things; but in the first place they forget we are not millionaire embezzlers with huge sums deposited in the banks; they forget that we are not rich and do not have private resources which we can place at the disposition of our cause, but which we would offer without vacillation if we had them, just as we offer the only thing we possess: our energy and our lives; they forget that a revolution is different from a military Putsch, it is the work of the people and it is necessary that the people be advised in order that they may know what is to be their part in the fight. In a revolution, as Marti said: "The methods are secret and the goals are public." Does anyone think perchance that when our liberators publicly were soliciting the assistance of the tobacco merchants of Tampa and Key West, they pretended to hide from the Spanish authorities that a revolution was being plotted in Cuba? If we are not embezzlers, if we are not rich, how are we going to obtain the means indispensable for the fight if not by soliciting them from the people? And how are we going to request assistance from the people if we do not talk to the people and advise them as to why we want their assistance? If the revolution robs a bank in order to obtain funds, the enemy will say that the revolutionaries are gangsters; if the revolution accepts aid from the embezzlers who plundered the republic, the revolution will be betraying its principles; if the revolution solicits aid from the

large interests, the revolution will be compromised before it achieves power.

Already we have entered into combat with the scarce resources which we could obtain by each one giving what he had and soliciting in silence the aid of a few generous persons, and the result was defeat and the frightful crimes which followed; then we would have done nothing had we asked publicly because no one would have paid any attention; their faith was placed in other men from whom everything was expected in opposition to the oppression. To date, after we have had to pay such a high price in sacrifices and lives for the consideration of our compatriots, we will do what we could not do at that time: go publicly to the people for their aid; prepare the country for the revolution on a large scale without possibilities of failure; give instructions that on all sides the masses must follow, when the national rebellion explodes like a tempest in order that the combat groups, well-armed and well-led, and the youth groups of action and agitation can be supported by the workers of the entire country who shall be organized from below in revolutionary cells capable of beginning a general strike. What the enemy never will know is where the arms are located and in what moment the insurrection will break out. If the politician publicly promulgates his electoral thesis, the revolution should publicly preach its thesis of rebellion.

To openly preach the revolution will, without doubt, bring better fruits than to speak of peace in public and conspire in secret, which was the method used during three and one-half years by the group which was removed from power on March 10, their secret never being secret from anybody. Thanks to our campaign it is seen that despite the return of the exiled "Autenticos" (party of Prio Socarras), which many interpreted erroneously as the end of the insurrectional phase, the sentiment and agitation is stronger than ever in the entire nation and our cry of "Revolution!...Revolution!" is the motto of the masses wherever the people meet. All of the electoral plans of the regime to perpetuate itself in power with the complicity of the political gangs of the pseudo-opposition have been broken up by our strategy. Only the blind or the cheap or the envious or the weak can deny it.

The national panorama is becoming clearer; events at last are proving us to be right. The massacres of workers, the street fights between students and police, the growing economic crisis with its resulting hunger and misery, the uncontrolled increase in the public debt which for the next thirty years compromises the credit of the nation, the men who have disappeared without leaving any trace, the unpunished crimes, the daily embezzlements, and the haughty and rotund refusal which the dictator gave to the hundred thousand citizens who were congregated at the "MUELLE DE LUZ" (dock of light), demonstrate that there is no other recourse for the country than the revolution. Those who thus far have continued to support any other idea at the present time have only two alternatives: either they bow to the regime or they ally themselves with the revolution, the standard of which only we have held on high when everyone was running in search of an electoral arrangement with the dictatorship. Even the most humble citizen correctly interprets the situation in Cuba when he affirms that Batista and his gang of millionaire generals have mocked public opinion for the past four years and they will not abandon their positions unless they are removed from them by force. To the cowards who express the opinion that he has the tanks, the cannons, and the airplanes, the reply of a worthy nation, of a people who has pride, should be: "Well then let us too obtain the necessary arms; let us deliver to the combatants the economic resources which they lack; if with that which the tyranny collects from us by force in taxes she is able to buy her arms and pay her executioners, let us voluntarily help with our resources those who for the past four years have fought and died for our redemption; let us help them because the duty of sacrificing oneself for one's country is for all and not for a few; let us help them because the frivolous life, the indifferent life, in the presence of a country which is in agony is a crime when others are suffering imprisonment or exile or lie beneath the vilified earth..."

Let each citizen contribute a peso; let each worker deliver the equivalent of one day's salary, as the Cuban emigrants of January 28 are going to do and they will see how the tyranny will fall apart suddenly in less time than many imagine.

Those of us who lead an austere and poor life,

dedicated to the struggle without rest and without respite, giving to the country our youth and our lives, working for six million Cubans without collecting anything from anyone, feel within us the morale and courage to speak to the nation in these terms. To ask is bitter even when it is for one's country, but it is more bitter to live as we live, oppressed; for a husband to see how an insolent person in uniform offends his wife; for a mother to see how they drag from her home a son or a husband in the middle of the night; for a man who is the father of a family to see how despite his years and his health they strike him and abuse him without any respect whatsoever in some police station; for the merchant to see how they take from him a package of tobacco or a pound of meat or a cup of coffee, the very agent who should protect him from the evildoers, and if not they fine him or accuse him unjustly of some violation; to see the barefoot child begging alms in the streets; to see the men with their arms folded on the corners; to see the lines before a foreign consulate soliciting visas to leave the country; to see, in summary, the innumerable injustices which occur daily within our view.

Let the people who see us suffer, who see us agonizing, who see us fighting, who see us asking alms for our country, give heed.

Others ask for themselves and place in security a house, a farm, jewelry, or any other property; we ask for Cuba and we place in security our lives; each peso which is deposited in our hands is a check which is issued against the existence of the men who have promised to die before giving up the undertaking in which they are engaged. And those who from egotism or miserliness refuse to help them will see them die with tremendous remorse of conscience, knowing that they are right and they fight for a just cause, for a noble ideal, for a worthy principle, for a common good.

We know that this call will not fall in a vacuum; already on one occasion when the newspaper "La Calle" was going to close for lack of resources we made a similar appeal and the people immediately began to help it in a splendid fashion. The regime had to close it. This time we are not asking for a newspaper; we are asking for the entire country; we are asking in order to purchase

the freedom of six million slaves; we are asking to serve a nation; the contributions, therefore, should be a thousand times more generous and more spontaneous.

The collection of funds on the part of a movement which operates clandestinely is a difficult task, but is perfectly operable in this case because of the organization and discipline of our groups scattered throughout the island.

It is imperative, nevertheless, that the following norms be followed:

No citizen should deliver anything to anyone in whom he does not have absolute confidence as to his honesty, seriousness, and moral prestige and the certainty that through him the donation will arrive at the Treasury of the Movement.

No one will have a carnet or any identification in this movement for the specific purpose of collecting funds, and the only valid credential of one of our militants for that purpose will be the prestige which he enjoys in the place where he is established or he exercises his profession.

No one should deliver a single cent to any person from another locality or from another work center or alleged place of employment in order that no unknown person can present himself in any locality as a member of the July 26 Movement for the purpose of collecting funds.

No one will be given a receipt or bond as evidence of his contribution since any document of this type would be compromising, not only for the one who delivers it, but also for the person receiving it. In due time, when the present circumstances of oppression have disappeared, honor lists will be formed with the names of the persons who have contributed as taken from the testimony of the members of our economic sections.

The dictatorship will be unable to take effective measures against this economic campaign because it is faced with a type of mass conspiracy.

Any impostor, who passes himself off as a member

~~CONFIDENTIAL~~

of our movement and attempts to collect funds in its name, will be discovered without delay by our militants who are alert and are everywhere and they shall make certain that he is given his proper punishment, as occurred in the Province of Matanzas to a rogue named Ramon Estevez, who was dedicating himself to that vile task, utilizing a false credential with our photograph superimposed thereon. There is no more effective vigilance than the collective vigilance.

All forms of collection by means of force or violence are completely foreign to our procedures.

The above-named norms of collection will be applied in national territory where our organization functions clandestinely but not in connection with the emigration where the patriotic clubs carry out their tasks under conditions of legality.

The Treasury of the Movement will maintain a minute record of income and expenditures concerning which it will make a complete account to the nation when its work has been concluded.

In name of the National Directorate of the
JULY 26 REVOLUTIONARY MOVEMENT, signed on the island of
Nassau, December 10, 1955.

FIDEL CASTRO

III. INFORMATION CONCERNING
JUAN MANUEL MARQUEZ

T-1 advised in the latter part of January, 1956, that
JUAN MANUEL MARQUEZ had joined FIDEL CASTRO in Mexico City and

[REDACTED]

T-1 was unable to furnish any background data concerning MARQUEZ, but expressed the belief that for many years he was a youth leader in the Cuban "Ortodoxo" political party and that he had been with FIDEL CASTRO at the time of the July 26, 1953, attack on the Moncada Hospital Barracks at Santiago de Cuba.

~~CONFIDENTIAL~~

ADMINISTRATIVE PAGE

Extra copies of this report are being provided for the Bureau for possible dissemination to the New York, Washington Field, and Miami [redacted] Offices. A copy hereof has been disseminated on a circulation basis to the Political Section of the American Embassy [redacted]

b3
b7E

In accordance with Bureau instructions, a stop has been placed with the Visa Section of the U. S. Embassy in the event either subject applies for a visa for entry into the United States. Personnel of the Embassy Visa Section have advised that they wish to communicate with FIDEL CASTRO on the basis of instruction from the Department of State, but it has not been deemed advisable to furnish subject's address at Calle Amparen #49 to them in view of the danger that to do so would compromise the principal source of information concerning this case.

Careful consideration has been given to each source concealed in this report, and T symbols have been utilized only where the identities of the sources must be concealed.

<u>Identity of Source</u>	<u>Date of Activity and/or Description of Information</u>	<u>Date Received</u>	<u>Agent to Whom Furnished</u>	<u>File No. Where Located</u>
T-1 [redacted]	Residence and employment	1/18/56 2/3/56	SA [redacted] [redacted] (orally)	Instant report
	Revolutionary activities	1/18/56	SA [redacted] [redacted] (orally)	Instant report
	Manifiesto	1/18/56	SA [redacted] [redacted] (orally)	Instant report
	Arrival of JUAN MANUEL MARQUEZ to Mexico	1/18/56	SA [redacted] [redacted] (orally)	Instant report

b6
b7C
b7D

[redacted] and who has furnished reliable information insofar as it has been possible to check same.

ADMINISTRATIVE PAGE

<u>Identity of Source</u>	<u>Date of Activity and/or Description of Information</u>	<u>Date Received</u>	<u>Agent to Whom Furnished</u>	<u>File No. Where Located</u>
T-2 [redacted]	[redacted]	12/23/55	SA [redacted] [redacted]	[redacted]
		11/30/55	SA [redacted] [redacted]	[redacted]

b6
b7C
b7D

LEAD

MEXICO CITY

AT MEXICO, D. F., MEXICO:

1. Will continue efforts to locate residence of subjects and to further identify JUAN MANUEL MARQUEZ.
2. Will continue to follow and report subjects' status and activities in Mexico.

REFERENCES

Mexico City airgram to Bureau dated 1/18/56.
Bureau letter to Assistant Attorney General [redacted]
dated 1/4/56.

b6
b7C

SAC, New York [redacted]

March 12, 1956

Director, FBI [redacted]

b3
b7E

FELIX ALEJANDRO CASTRO RIZ, wa;
JUAN MANUEL MARQUEZ

[redacted]

For the information of the New Haven, Chicago, and Philadelphia Offices, which have not received any previous correspondence in this matter, Castro was the leader of a revolutionary attack on the Moncada Army Barracks at Santiago, Cuba, on 7-26-53. He was imprisoned by Cuban authorities as a result of this activity, but in May, 1955, he was released under a general amnesty law. During July, 1955, Castro and Marquez, who had also taken part in the attack on the Moncada Army Barracks, travelled to Mexico and during October, 1955, they entered the U.S. at San Antonio, Texas. The subjects subsequently addressed meetings of Cuban emigrants at New York City and Miami, Florida, and vicinity, during the course of which they advocated the violent overthrow of the present Cuban Government headed by President Fulgencio Batista and solicited funds for this purpose. The subjects also attempted to organize various groups, using the name "Patriotic Clubs of July 26," "July 26 Club of New York" and similar titles. The subjects departed from the U.S. at Miami, Florida, on 12-10-55 for Mexico and are presently residing in Mexico City. The Internal Security Division of the Department has advised that the subjects are under an obligation to register with the Attorney General under terms of the Registration Act in the event they should return to this country.

Enclosure

b3
b6
b7C
b7E

cc - 2 - Miami [redacted] (enclosure)

cc - 2 - Washington Field [redacted] enclosure

cc - 2 - Newark [redacted] (enclosure)

cc - 2 - New Haven (enclosure)

cc - 2 - Chicago (enclosure)

cc - 2 - Philadelphia (enclosure)

SEARCHED	INDEXED
SERIALIZED	FILED
MAR 13 1956	
FBI - WASHINGTON	

Letter to SAC, New York

There is enclosed herewith for each office receiving a copy of this letter one copy of the report of SA [redacted] dated 2-10-56 at Mexico City. Attention is directed to page 3, paragraph C., of this report, which sets forth a translation of a "Manifesto" issued by Castro under date of 12-10-55. According to this document, "Patriotic Clubs" have been organized at Bridgeport, Union City, New York, Miami, Tampa, and Key West and "new nuclei" will be organized in Chicago, Philadelphia, and Washington.

b6
b7C

The New York and Miami Offices have previously been instructed to institute appropriate investigation concerning any such groups organized by the subjects in their territories. The New Haven and Newark Offices are instructed to contact established sources and conduct other appropriate investigation to determine whether similar groups have been organized at Bridgeport, Connecticut, and Union City, New Jersey. [redacted]

b3
b7E

[redacted] The Chicago, Philadelphia, and Washington Field Offices should alert their established sources so as to be promptly advised in the event similar groups are founded in these cities.

FEDERAL BUREAU OF INVESTIGATION

~~CONFIDENTIAL~~

FORM No. 1
THIS CASE ORIGINATED AT **NEW YORK**

b3
b6
b7C
b7E

REPORT MADE AT WASHINGTON, D. C.	DATE WHEN MADE APR 10 1956	PERIOD FOR WHICH MADE 1/23;2/10,15; 3/15/56	REPORT MADE BY [redacted]
TITLE FIDEL ALEJANDRO CASTRO RUZ, wa.; JUAN MANUEL MARQUEZ			CHARACTER OF CASE [redacted]

SYNOPSIS OF FACTS:

INS files reflect one **JUAN MANUEL MARQUEZ Y RODRIGUEZ**, 141 West 75th Street, New York City, admitted to U. S. at San Antonio, Texas, 10/20/55. Admitted to 11/5/55.

- RUC ✓ [redacted]

DETAILS: AT WASHINGTON, D. C.

SE [redacted] caused a search to be made of the files of the Central Office of the United States Immigration and Naturalization Service (INS) and was advised on March 15, 1956, that these files reflect the following information regarding one **JUAN MANUEL MARQUEZ Y RODRIGUEZ**:

Birth date:	July 5, 1915.
Birthplace:	Punta Brava, Cuba
Home address:	141 West 75th Street, New York City
Address in United States:	Transit
Hair:	Brown
Eyes:	Green
Height:	5 feet 3 inches

b6
b7C
b6
b7C

APPROVED AND FORWARDED: [redacted]	SPECIAL AGENT IN CHARGE [redacted]	DO NOT WRITE IN THESE SPACES
COPIES OF THIS REPORT		Searched [redacted]
8 - Bureau [redacted]		Serialized [redacted]
3 - New York [redacted] (RM)		Indexed [redacted]
1 - Miami [redacted] (Info) (RM)		Filed [redacted]
① - Washington Field [redacted]		

b3
b6
b7C
b7E

PROPERTY OF FBI--This report is loaned to you by the FBI, and neither it nor its contents are to be distributed outside the agency to which loaned.

~~CONFIDENTIAL~~

~~CONFIDENTIAL~~

b3
b7E

[REDACTED]

Weight: 165 pounds
Nationality: Cuban
Race: White
Occupation: Constructor
Passport: Cuban passport No. 18684 dated August 7, 1953.

MARQUEZ entered the United States at San Antonio, Texas, on October 20, 1955, and was admitted to November 5, 1955. He previously entered the United States on September 9, 1955. It was noted MARQUEZ was in transit when admitted to the United States on October 20, 1955. His nearest relative was noted to be Mrs. MARQUEZ, residing at 141 West 75th Street, New York City.

SA [REDACTED] caused a search to be made of the files of the Office of Security, United States Department of State, and was advised on February 15, 1956, that no record of subject was found in the Visa Office and that the files of the Office of Security contained no additional information.

b6
b7C

- RUC -

~~CONFIDENTIAL~~

[REDACTED]

b3
b7E

ADMINISTRATIVE DATA

Eight copies of this report are being furnished the Bureau because eight copies of referenced report were furnished the Bureau.

LEADS

MIAMI DIVISION: (INFORMATION)

One copy of this report is being furnished the Miami Division as Miami is a port of entry and will probably have other leads in this case.

REFERENCES

Report of SA [REDACTED] dated 1/4/56 at Miami, Florida.
WFO letter to the Bureau dated 1/26/56.

b6
b7C

ADMINISTRATIVE PAGE

FEDERAL BUREAU OF INVESTIGATION

FORM NO. 1
THIS CASE ORIGINATED AT **BUREAU**

REPORT MADE AT NEW HAVEN	DATE WHEN MADE 4/20/56	PERIOD FOR WHICH MADE 3/19, 27; 4/12, 13, 17/56	REPORT MADE BY SA [redacted]
TITLE FIDEL ALEJANDRO CASTRO RUIZ, wa., Fidel Castro Ruz; JUAN MANUEL MARQUEZ			CHARACTER OF CASE [redacted]

b3
b6
b7C
b7E

SYNOPSIS OF FACTS:

Persons contacted advised never heard of subjects and have not heard of any club composed of Cubans in Bridgeport similar to "Patriotic Club of July 26". These persons noted "Dicoo-Cubano de Bridgeport", recreational club, only Cuban club in Bridgeport to their knowledge.

RUC

DETAILS: AT BRIDGEPORT, CONNECTICUT

On March 27, 1956, T-1, who has furnished reliable information in the past, and who is familiar with certain phases of the activities of the Spanish speaking people in Bridgeport, Connecticut, advised that he has never heard of captioned subjects or of a Cuban club known as the "Patriotic Club of July 26", or any club with a similar name. T-1 stated that the local Cubans have a club known as "Dicoo-Cubano de Bridgeport", but according to T-1, this club has been in existence for many years and is a recreational club. T-1 related that he would contact his Cuban sources and attempt to determine if such a club had been established in Bridgeport, Connecticut.

APPROVED AND FORWARDED	SPECIAL AGENT IN CHARGE	DO NOT WRITE IN THESE SPACES	
COPIES OF THIS REPORT 6-Bureau [redacted] 1-Miami [redacted] (Info.) 1-INFO [redacted] (Info.) 1-Newark [redacted] (Info.) 1-Chicago (Info.) 1-Philadelphia (Info.) (cont. P2)		SEARCHED [redacted]	INDEXED [redacted]
		SERIALIZED [redacted]	FILED [redacted]
		MAY 2 - 1956 FBI - WASHINGTON	

b3
b6
b7
b7

PROPERTY OF FBI—This report is loaned to you by the FBI, and neither it nor its contents are to be distributed outside the agency to which loaned.

[redacted]

On April 12, 1956, T-1 advised that he had contacted several Cuban sources and all advised that they were not familiar with the above-captioned subjects and had not heard of any Cuban club being formed in Bridgeport with a name similar to "Patriotic Club of July 26".

On the dates indicated, the following individuals, who advised that they are familiar with certain phases of the activities of Spanish speaking people in the Bridgeport, Connecticut area were contacted and all advised that they had never heard of the subjects, and knew of no club in the Bridgeport, Connecticut area with a name similar to "Patriotic Club of July 26". All advised that the only Cuban Club with which they were familiar in the Bridgeport area was a recreational club known as "Liceo-Cubano de Bridgeport."

[redacted]

(contacted on 4/13/56)

[redacted]

(contacted on 4/13/56)

[redacted]

(contacted on 4/17/56)

b6
b7C
b7D

RUC

Copies continued

1-New Haven [redacted]

b3
b7E

[Redacted]

b3
b7E

Extra copies of this report are being furnished to the Bureau inasmuch as the Bureau may desire to disseminate copies to Mexico City.

Information copies are being forwarded to Miami, Washington Field Office, Newark, Chicago, and Philadelphia, in view of the interest of those offices in this matter.

It is noted that [Redacted] mentioned in the details of this report, are sources of information of the New Haven Office. All persons contacted related they would advise the New Haven Office if any information concerning such a club should come to their attention.

b6
b7C
b7D

Identity of Source	Date, Activity	Date Received	Agent	File
T-1. PCI [Redacted]	Negative	3/27/56	SA [Redacted] [Redacted]	Instant Report
	" "	4/12/56	" "	" "

b6
b7C
b7D

REFERENCE: Bureau letter to New York dated 3/12/56.
Report of SA [Redacted] dated 2/10/56
at Mexico, D.F.

b6
b7C

ADMINISTRATIVE PAGE

TO: SAC, Washington Field

For information

XX

b3
b7E

For appropriate action

SEARCHED _____	INDEXED _____
SERIALIZED _____	FILED _____
APR 12 1956	
FBI - WASHINGTON	
<input type="checkbox"/>	<input type="checkbox"/>

b3
b6
b7C
b7E

~~CONFIDENTIAL~~

b6
b7C

FEDERAL BUREAU OF INVESTIGATION

Form No. 1
THIS CASE ORIGINATED AT **BUREAU**

REPORT MADE AT HAVANA, CUBA	DATE WHEN MADE 3/27/56	PERIOD FOR WHICH MADE 3/20,23/56	REPORT MADE BY []
TITLE CHANGED FIDEL ALEJANDRO CASTRO RUIZ, wa. Fidel Castro Rusy JUAN MANUEL MARQUEZ RODRIGUEZ		CHARACTER OF CASE []	

b3
b6
b7C
b7E

SYNOPSIS OF FACTS:

Juan Manuel Marquez Rodriguez

Background and descriptive information is set out re JUAN MANUEL MARQUEZ, who is allegedly associated with FIDEL CASTRO in collecting money to buy arms for use in Cuban insurrectional movement. He is reported to be in Mexico at the present time. His exact activities and address are unknown.

- F -

The title of this case has been changed to show the full name of subject JUAN MANUEL MARQUEZ RODRIGUEZ, as furnished by T-1, a confidential source abroad.

C

APPROVED AND FORWARDED:	SPECIAL AGENT IN CHARGE	[]	PLACES
COPIES OF THIS REPORT		SEARCHED [] INDEXED [] SERIALIZED [] FILED [] APR 2 1956 FBI - WASHINGTON	[]
12-Bureau 2-Havana	[]	(Encls.-3)	[]

b3
b6
b7C
b7E

~~CONFIDENTIAL~~

~~CONFIDENTIAL~~



United States Department of Justice
Federal Bureau of Investigation

Washington, D. C.
March 27, 1956

Re: FIDEL ALEJANDRO CASTRO RUIZ,
wa. Fidel Castro Rus;
JUAN MANUEL MARQUEZ RODRIGUEZ

T-1, a confidential source abroad, advised on March 20, 1956, that JUAN MANUEL MARQUEZ RODRIGUEZ, who is ordinarily known as JUAN MARQUEZ, is alleged to have been associated with FIDEL CASTRO while he was in the United States collecting money with which to buy arms for use in Cuban insurrectional movement. T-1 reported that MARQUEZ is believed to be in Mexico with CASTRO at the present time. However, his exact activities and address are unknown.

T-1 claims that MARQUEZ has a long history of insurrectional activity in Cuba, and that he was a Communist in the year 1933. According to T-1, he took part in the uprising at Santiago, Cuba on July 26, 1953, when raiders led by CASTRO attacked the Cuban Army fortress, "Cuartel Moncada."

According to T-1, [redacted]

b7D

T-1 states that [redacted]

b6
b7C
b7D

T-2, who has furnished reliable information in the past, advised [redacted]

b7D

[redacted] No additional information is available from T-2 concerning this matter.

- 1 -
~~CONFIDENTIAL~~

~~CONFIDENTIAL~~

T-1 furnished the following

[Redacted]

[Large Redacted Area]

b7D

~~CONFIDENTIAL~~

ADMINISTRATIVE

A copy of this report has been disseminated to [redacted]

b3
b7E

Four extra copies are being submitted to the Bureau for possible dissemination to the New York [redacted] Washington Field, Miami [redacted] and Mexico City [redacted] Offices.

b3
b7E

One negative and two prints of photograph of JUAN MANUEL MARQUEZ RODRIGUEZ, which were furnished by T-1, are enclosed in the event it is desired to forward them to Mexico City or to have extra copies made for other offices.

Careful consideration has been given to each source concealed in this report and T symbols have been utilized only where the identity of the sources must be concealed.

INFORMANTS

<u>Identity of Source</u>	<u>Date of Activity and/or Description of Information</u>	<u>Date Received</u>	<u>Agent to Whom Furnished</u>	<u>File Number Where Located</u>
T-1 [redacted]	Information re subject JUAN MANUEL MARQUEZ RODRIGUEZ	3/20/56	[redacted]	Instant Report
T-2 Confidential Informant [redacted] of the Havana Office	Information re subject JUAN MANUEL MARQUEZ RODRIGUEZ	Sept. 1945	[redacted]	[redacted]

b6
b7C
b7D

b3
b6
b7C
b7D
b7E

LEADS

HAVANA:

At Havana, Cuba

Will continue efforts to obtain information concerning present residence and activities of subject.

ADMINISTRATIVE PAGE

REFERENCE

Report of SA dated February 10, 1956, at
Mexico, D. F.

b6
b7c

ADMINISTRATIVE PAGE

Legal Attache
Havana, Cuba

[Redacted]

April 30, 1956

Director, FBI

[Redacted]

b3
b7E

FIDEL ALJANDRO CASTRO RUIZ, was;
JUAN MANUEL MARQUEZ

[Redacted]

Memorandum 3-27-56 forwarding a copy of the fingerprints of
Juan Manuel Marquez Rodriguez

[Redacted]

b7D

These prints have been searched through the records
of the Identification Division and it has been determined that Juan
Manuel Marquez Rodriguez, FBI Number 232 150 C, was fingerprinted
as an alien on 12-14-53, place and fingerprinting agency not shown.

The foregoing is for your information.

- cc - 1 - New York [Redacted] (Info)
- Miami [Redacted] (Info) ✓
- Washington Field [Redacted] (Info)
- Newark [Redacted] (Info)
- Mexico City (Info)

b3
b7E

W

b3
b6
b7C
b7E

[Redacted]	
SEARCHED [Redacted]	INDEXED [Redacted]
SERIALIZED [Redacted]	FILED [Redacted]
APR 30 1956	
FBI - WASHINGTON	
[Redacted]	

FEDERAL BUREAU OF INVESTIGATION

FORM No. 1
THIS CASE ORIGINATED AT

BUREAU

~~CONFIDENTIAL~~

C

REPORT MADE AT MEXICO, D. F.	DATE WHEN MADE OCT 2 1956	PERIOD FOR WHICH MADE 9/19,20/56	REPORT MADE BY [redacted]
TITLE FIDEL ALEJANDRO CASTRO RUZ, WA; JUAN MANUEL MARQUEZ		CHARACTER OF CASE [redacted]	

b3
b6
b7C
b7E

SYNOPSIS OF FACTS:

Subject CASTRO and alleged associates arrested by agents of the Mexican National Security Police on 6/21/56 and thereafter and charged with "illegal political activity." Most of the group were released on 7/9/56, and CASTRO was released 7/21/56, allegedly on condition that he leave Mexico as soon as possible and abstain from political activity prior to his departure. As of 9/18/56 CASTRO reported to be still residing in Mexico City at Calle Panuco #221 and to be continuing his efforts to organize a revolutionary attack against the BATISTA government.

b7D

-P-

~~CONFIDENTIAL~~

APPROVED AND FORWARDED:	SPECIAL AGENT IN CHARGE	DO NOT WRITE IN THESE SPACES	
COPIES OF THIS REPORT		SEARCHED [redacted] INDEXED [redacted]	
11 - Bureau [redacted]		SERIALIZED [redacted] FILED [redacted]	
1 - American Embassy [redacted]		OCT 23 1956	
[redacted] (circulation)		FBI - WASHINGTON	
1 - Mexico City [redacted]		[redacted]	

b3
b6
b7C
b7E

PROPERTY OF FBI—This ~~confidential~~ report and its contents are loaned to you by the FBI and are not to be distributed outside of agency to which loaned.

~~CONFIDENTIAL~~

UNITED STATES DEPARTMENT OF JUSTICE
FEDERAL BUREAU OF INVESTIGATION

In Reply, Please Refer to
File No.

Washington 25, D. C.

OCT 2 1956

RE: FIDEL ALEJANDRO CASTRO RUZ, WA;
JUAN MANUEL MARQUEZ

I. BACKGROUND DATA

A. Residence

On September 19, 1956, T-1, who has furnished reliable information in the past, advised that he had received unconfirmed information [redacted]

[redacted] to the effect that CASTRO is presently residing in Mexico City at Calle Panuco #221.

b7D

B. Employment

T-1 reported that CASTRO continues in his efforts to further a revolutionary attempt against the government of Cuban President FULGENCIO BATISTA.

T-2, who has furnished reliable information in the past, advised on September 18, 1956, [redacted]

b7D

II. ARREST OF SUBJECT AND ASSOCIATES
BY MEXICAN NATIONAL SECURITY POLICE

On June 22, 1956, T-3, who has furnished reliable information in the past, advised that on the early morning of the previous day agents of the Mexican National Security Police (Direccion Federal de Seguridad--DFS) had arrested FIDEL CASTRO RUZ and a number of his followers when they had been observed openly carrying firearms. According to T-3, those arrested were FIDEL CASTRO RUZ, [redacted]

b6
b7C

~~CONFIDENTIAL~~

[REDACTED]

T-3 reported that [REDACTED]

[REDACTED]

b6
b7C
b7D

The Mexico City daily newspaper "Excelsior" of June 26, 1956, reported that, on the basis of information obtained through interrogation of the subjects arrested earlier and examination of documents in their possession, the following other persons had been arrested:

[REDACTED]

b6
b7C

The above-mentioned article stated that at the time of his arrest CASTRO RUZ and several of his associates were traveling in a 1950 model Packard bearing Florida license plates [REDACTED].

b6
b7C

T-4, who has furnished reliable information in the past, advised on June 28, 1956, [REDACTED]

[REDACTED]

b6
b7C
b7D

The Mexico City daily newspaper "Novedades" of June 27, 1956, carried an article which claimed that the DFS had uncovered "Red infiltration of the plot against F. BATISTA." In explanation of the foregoing, the article stated that among the

subjects detained was ERNESTO GUEVARA SERNA, an Argentine national and a political refugee from Guatemala following the overthrow of the ARBENZ government. The article continued that GUEVARA SERNA is an active member of the Mexican-Russian Cultural Institute and that his wife, HILDA GODEA DE GUEVARA, is a Peruvian political refugee. The foregoing article stated the Cuban group had been carrying out an active training program in the use of firearms at a ranch known as "Rancho de Santa Rosa," located near Chalco, State of Mexico, and that the training had been directed by ALBERTO BAYO GIROUT, a naturalized Mexican citizen of Spanish origin who had been a Colonel in the Spanish Civil War.

The article continued that the newspaper had received a letter from BAYO stating that he was being sought by the police and accepting full responsibility for the training and preparation of the Cuban revolutionaries. In the letter he claimed to be the "sole leader of the group" and stated that he would deliver himself to the police if he were promised that he would not be interrogated concerning the movement.

The "Excelsior" of July 10, 1956, reported that on the previous day nineteen subjects had been released by the Ministry of Interior (Gobernacion) and stated that only FIDEL CASTRO RUZ, ERNESTO GUEVARA, CALIXTO GARCIA, and SANTIAGO HIRZEL had been retained because it had been determined that their residence permits for Mexico had expired. Among those listed as having been released was ALBERTO BAYO COSGAYA.

The Mexico City daily newspaper "Novedades" of July 10, 1956, reported the release of nineteen Cubans and the naturalized Mexican citizen, ALBERTO BAYO, and quoted the Director of the Immigration Section of the Mexican Ministry of Interior, Mr. ARCADIO OJEDA, to the effect that the subjects had been released when it was determined that their tourist cards were in order. The article continued that upon being released the Cubans were "invited" to leave Mexico.

The "Novedades" of July 11, 1956, reported that SANTIAGO LIBERATO HIRZEL had been released by Mexican Immigration authorities on the previous day.

The "Excelsior" of July 26, 1956, reported that FIDEL CASTRO RUZ and his two remaining "accomplices" who had continued

in confinement with him had been released by Mexican Immigration authorities and that they immediately had begun seeking entry permits for other countries in order to carry out the requirement of the Mexican authorities that they leave Mexico as soon as possible.

T-5, who has furnished reliable information in the past, advised that

b7D

b7D

b3
b6
b7C
b7E

~~CONFIDENTIAL~~

[REDACTED]

b3
b6
b7C
b7E

V. PRESENT ACTIVITIES OF FIDEL CASTRO RUZ

T-1 advised on September 19, 1956, that he had received information from a person of unknown reliability, [REDACTED]

b7D

[REDACTED]

T-2 advised on September 18, 1956, that [REDACTED]

b7D

[REDACTED]

According to T-2, [REDACTED]

b7D

[REDACTED]

~~CONFIDENTIAL~~

ADMINISTRATIVE PAGE

Extra copies of this report are being provided for possible dissemination to the New York [redacted] Washington Field (WFO [redacted] and Miami [redacted] Offices, and the Legat at Havana ([redacted]). A copy hereof has been disseminated on a circulation basis to the Political Section of the American Embassy [redacted]

b3
b7E

Contradictory reports have been received to the effect that CASTRO RUZ is in Mexico City and that he has traveled to Costa Rica. Information from [redacted] and [redacted] indicates he is still in Mexico and still active. This office is endeavoring to verify his reported residence address and obtain additional information concerning his activities.

b6
b7C
b7D

Careful consideration has been given to each source concealed in this report, and T symbols have been utilized only where the identities of the sources must be concealed.

<u>Identity of Source</u>	<u>Date of Activity and/or Description of Information</u>	<u>Date Received</u>	<u>Agent to Whom Furnished</u>	<u>File No. Where Located</u>
T-1 Confidential Contact [redacted]	Residence and employment of FIDEL CASTRO; continues revolutionary activities	9/19/56	SA [redacted] [redacted] (orally)	Instant report
(concealed by request)	[redacted]	9/19/56	SA [redacted] [redacted] (orally)	Instant report
T-2 Confidential Contact [redacted]	Employment and CASTRO continues revolutionary activities	9/18/56	SA [redacted] [redacted] (orally)	Instant report
(concealed by request)	[redacted]	9/18/56	SA [redacted] L. [redacted] (orally)	Instant report
		7/27/56	SA [redacted] [redacted] (orally)	[redacted]

b6
b7C
b7D

b3
b6
b7C
b7D
b7E

ADMINISTRATIVE PAGE

<u>Identity of Source</u>	<u>Date of Activity and/or Description of Information</u>	<u>Date Received</u>	<u>Agent to Whom Furnished</u>	<u>File No. Where Located</u>	
T-3 [redacted]	Arrest of subject and associates, 6/21/56	6/22/56	SA [redacted] [redacted]	[redacted]	b6 b7C b7D b7E
T-4 [redacted] [redacted] (concealed by request)	[redacted]	6/29/56	SA [redacted] [redacted] (orally)	Instant report	
T-5 SA [redacted] [redacted] who obtained info from [redacted]	[redacted]	9/12/56	SA [redacted] [redacted] (orally)	Instant report	b6 b7C b7D
[redacted]	[redacted]	[redacted]	[redacted]	[redacted]	
[redacted]	[redacted]	[redacted]	[redacted]	[redacted]	
Info from [redacted] [redacted] [redacted]	[redacted]	6/26/56	SA [redacted] [redacted] (orally)	Instant report	b6 b7C b7D
T-6 [redacted] [redacted]	[redacted]	[redacted]	Legat	[redacted]	b3 b7E
[redacted]	[redacted]	[redacted]	[redacted]	[redacted]	

LEAD

MEXICO CITY

AT MEXICO, D. F., MEXICO:

Will endeavor to verify subject's residence in Mexico City and continue to follow and report his activities and status.

ADMINISTRATIVE PAGE

REFERENCES

Report of SA Havana, 8/14/56.
Mexico City airgram to Bureau dated 8/6/56.

b6
b7c

TO: SAC, Washington Field

For information

For appropriate action

[Redacted]	
SEARCHED []	INDEXED []
SERIALIZED []	FILED []
OCT 23 1956	
FBI - WASHINGTON	
[Redacted]	

b3
b6
b7C
b7E

FEDERAL BUREAU OF INVESTIGATION

C

REPORTING OFFICE MEXICO, D. F.	OFFICE OF ORIGIN BUREAU	DATE MAR 18 1957	INVESTIGATIVE PERIOD 3/8, 11/57
TITLE OF CASE FIDEL ALEJANDRO CASTRO RUZ, wa.; JUAN MANUEL MARQUEZ		REPORT MADE BY [REDACTED]	TYPED BY [REDACTED]
		CHARACTER OF CASE [REDACTED]	

b3
b6
b7C
b7E

SYNOPSIS:

FIDEL ALEJANDRO CASTRO RUZ and a group of his revolutionary followers are reported to have departed Mexico clandestinely by private yacht on 11/25/56. In a twelve-page leaflet-size newspaper entitled, "Revolucion," and dated "the first half of February, 1957," the claim is made that CASTRO and his group continue to combat the BATISTA Government from their hideout in the "Sierra Maestra" mountains of Cuba. JUAN MANUEL MARQUEZ arrived in Mexico City from Miami on 11/4/56, and reportedly was in consultation with CASTRO before he returned to Miami. Informant speculates

[REDACTED]

b7D

- RUC -

APPROVED	SPECIAL AGENT IN CHARGE	DO NOT WRITE IN SPACES BELOW	
COPIES MADE: 11 - Bureau [REDACTED] 1 - American Embassy [REDACTED] 1 - Mexico City [REDACTED]		[REDACTED]	[REDACTED]

b3
b6
b7C
b7E

SEARCHED [REDACTED] INDEXED [REDACTED]
SERIALIZED [REDACTED] FILED [REDACTED]
APR 8 1957
FBI - WASHINGTON
[REDACTED]

~~CONFIDENTIAL~~

UNITED STATES DEPARTMENT OF JUSTICE
FEDERAL BUREAU OF INVESTIGATION

In Reply, Please Refer to
File No.

Washington, D. C.

MAR 18 1957

RE: FIDEL ALEJANDRO CASTRO RUZ,
wa.;
JUAN MANUEL MARQUEZ

I. PRESENT WHEREABOUTS OF
FIDEL CASTRO RUZ

On February 25, 1957, T-1, who has furnished reliable information in the past, made available a copy of a twelve-page leaflet-size newspaper bearing the title, "Revolucion," and the designation, "Official Organ of the July 26 Revolutionary Movement, published somewhere in Cuba, first half of February, 1957." T-1 stated that

b7D

One of the principal articles in the above-described leaflet was entitled, "From Mexico to the Sierra Maestra." This article purported to be written by one of the companions of FIDEL CASTRO RUZ and discussed the arrangements made in Mexico in advance for the shipment of arms and personnel and the training of personnel in Mexico prior to their embarking for Cuba. The article related that the group had been betrayed to the Mexican Police by a "traitor" and as a result had lost some equipment as well as three companions who were incarcerated. It continued that on November 25, 1956, eighty-two men had boarded the yacht "Gramma" to begin their ocean voyage to Cuba.

On a one-page supplement to the publication, "Revolucion", there appeared a reproduction of a photograph of FIDEL CASTRO RUZ and the following statement:

"Our great leader, Fidel Castro, continues to fight valiantly against the forces of the dictatorship from the Sierra Maestra (mountains), continually gaining to a greater extent the admiration and the support of the Cuban people who see in the movement which he represents the greatest hope for national liberation."

With respect to the activities of subject immediately prior to the departure of his group from Mexico, the following was provided by T-2, who has furnished reliable information in the past, on December 3, 1956:

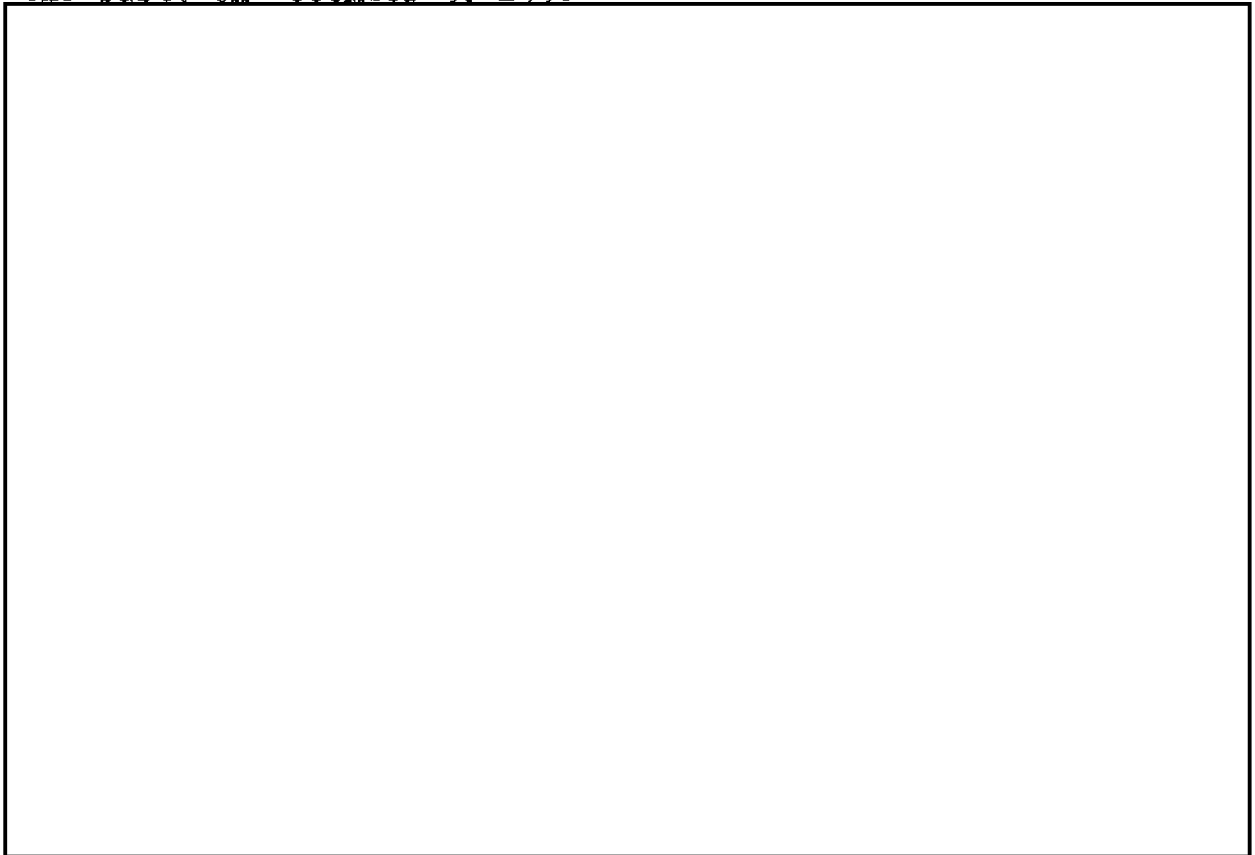

b6
b7C
b7D

b7D

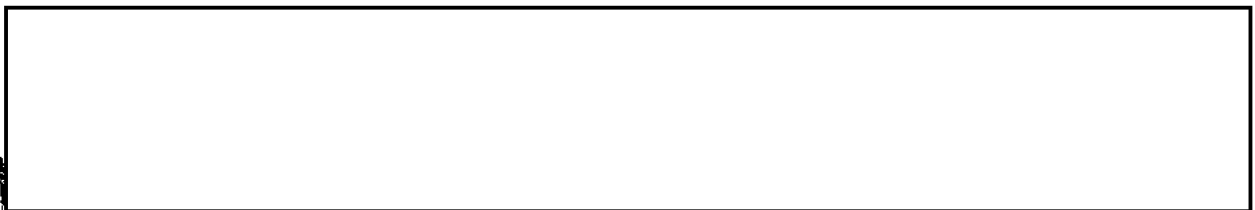

b7D

II. TRAVEL TO MEXICO OF
JUAN MANUEL MARQUEZ

The following information was furnished by T-3, who has furnished reliable information in the past, on November 19, 1956:

[REDACTED]

b6
b7C
b7D

On November 22, 1956, T-3 advised that he had

[REDACTED]

b6
b7C
b7D

T-4, who has furnished reliable information in the past, advised that JUAN MANUEL MARQUEZ had returned to Miami from Mexico by bus [REDACTED]

[REDACTED]

T-1 advised on November 22, 1956, that he had heard from Cuban acquaintances in Mexico City that JUAN MANUEL MARQUEZ had arrived in Mexico City and was said to be in contact with FIDEL CASTRO RUZ. T-1 also stated that

b6
b7C
b7D

[REDACTED]

III. [REDACTED]
CONCERNING CASTRO RUZ

b7D

The following extract of information relating to CASTRO RUZ was furnished by T-3 on January 28, 1957:

[REDACTED]

b7D

ADMINISTRATIVE

Extra copies of this report are being provided for dissemination to the New York [redacted], Washington Field (WFO [redacted] and Miami (MM [redacted] offices and the Legat at Havana [redacted]

b3
b7E

A copy hereof has been disseminated on a circulation basis to the Political Section of the American Embassy [redacted]

In view of the fact that it appears to be clearly established that FIDEL CASTRO is presently operating against the BATISTA Government from within Cuba, no further investigation of this case is contemplated by this office, UACB. This office will, however, continue to report such information as is received from its sources concerning other Cuban revolutionary activities in Mexico.

Careful consideration has been given to each source concealed in this report and T symbols have been utilized only where the identities of the sources must be concealed.

SOURCES

<u>Identity of Source</u>	<u>Date of Activity and/or Description of Information</u>	<u>Date Received</u>	<u>Agent to Whom Furnished</u>	<u>File Number Where Located</u>
T-1 Confidential Contact [redacted]	Whereabouts of FIDEL CASTRO and newspaper "Revolucion"	2/25/57	[redacted] (orally)	Instant report
(concealed by request)	Activities of JUAN MANUEL MARQUEZ	11/22/56	[redacted] (orally)	Instant report
T-2 [redacted]	All information	12/3/56	[redacted]	

b6
b7C
b7D

ADMINISTRATIVE PAGE

SOURCES

<u>Identity of Source</u>	<u>Date of Activity and/or Description of Information</u>	<u>Date Received</u>	<u>Agent to Whom Furnished</u>	<u>File Number Where Located</u>
---------------------------	---	----------------------	--------------------------------	----------------------------------

T-3

[redacted]	Arrival of MARQUEZ in Mexico	11/19/56	[redacted]	
------------	------------------------------	----------	------------	--

	MARQUEZ outside Mexico City	11/22/56		
--	-----------------------------	----------	--	--

[redacted]	[redacted]	1/28/57		
[redacted]	re FIDEL CASTRO			

b6
b7C
b7D

T-4

[redacted]	Return of MARQUEZ to Miami	(Information in Miami teletype to Bureau dated 11/29/56)		
------------	----------------------------	--	--	--

b6
b7C
b7D

REFERENCE: Bureau airgram dated 2/6/57

Report of SA [redacted] dated at Mexico, D. F., 10/2/56.

b6
b7C

ADMINISTRATIVE PAGE

TO: SAC, Washington Field

For information

For appropriate action

~~Handwritten scribble~~

b3
b6
b7C
b7E

[Redacted]	
SEARCHED []	INDEXED []
SERIALIZED []	FILED []
APR 8 1957	
FBI - WASHINGTON	
[Redacted]	

FEDERAL BUREAU OF INVESTIGATION

~~CONFIDENTIAL~~

REPORTING OFFICE MIAMI	OFFICE OF ORIGIN NEW YORK	DATE JUN 19 1957	INVESTIGATIVE PERIOD 11/7,23/56;6/6/57
TITLE OF CASE FIDEL ALEJANDRO CASTRO-RUZ, wa. JUAN MANUEL MARQUEZ		REPORT MADE BY [redacted]	TYPED BY [redacted]
		CHARACTER OF CASE [redacted]	

b3
b6
b7C
b7E

SYNOPSIS:

MARQUEZ reportedly last departed Miami clandestinely in 11/56; was reportedly killed fighting in Cuba.

-RUC-

DETAILS: AT MIAMI, FLORIDA

On November 7, 1956, [redacted] Aerovias Guest Airlines, Miami, advised that JUAN MANUEL MARQUEZ, described as a Cuban, departed Miami for Mexico on November 4, 1956.

b6
b7C

On November 23, 1956, Miami Informants T-1 and T-2, both of whom have reported reliable information in the past, advised that MARQUEZ returned to Miami by bus on the night of November 22, 1956. [redacted]

b6
b7C
b7D

Subsequently, newspaper reports reflected that JUAN MANUEL MARQUEZ had reportedly been killed in fighting following his landing in Cuba with a contingent of Cuban revolutionaries led by FIDEL CASTRO, which landing took place

APPROVED	SPECIAL AGENT IN CHARGE	DO NOT WRITE IN SPACES BELOW
----------	-------------------------	------------------------------

- COPIES MADE:
- 11 - Bureau [redacted] (RM)
 - 3 - New York [redacted] (RM)
 - 2 - Washington Field [redacted] (RM)
 - 2 - Miami [redacted]

[Handwritten signature and initials]

b3
b6
b7C
b7E

[Handwritten note: not ins of 6/15/57]

SEARCHED	INDEXED
SERIALIZED	FILED
JUN 20 1957	
FBI - WASHINGTON	

~~DELETE CLASSIFICATION~~

[Handwritten: 6-18/28/57]

[REDACTED]

b3
b7E

November 30, 1956.

On several different occasions in December, 1956
and January and February, 1957, T-1 advised that [REDACTED]

[REDACTED]

[REDACTED] T-1 said that MARQUEZ allegedly
left the United States by clandestine means in November,
1956.

b7D

-RUC-

[redacted]

b3
b7E

-INFORMANTS-

T-1 is [redacted]
[redacted] who furnished information to SA [redacted]
on 11/23/56 and on several occasions in December, 1956 and
January and February, 1957.

b6
b7C
b7D

T-2 is [redacted] who reported on
November 23, 1956 to SA [redacted] instant case.

Careful consideration has been given to each source
concealed in this report and T-symbols have been used only in
those instances where identity must be concealed.

-LEADS-

WASHINGTON FIELD:

AT WASHINGTON, D. C.

At Central Office, INS, will check entry and
departure records for last departure and destination of subject
JUAN MANUEL MARQUEZ.

-REFERENCES-

5/27/57. Report SA [redacted] New York,

b6
b7C

-ADMINISTRATIVE PAGE-

DIRECTOR, FBI [redacted] *DR*

7/15/57

b3
b7E

SAC, WFO [redacted]

FIDEL ALEJANDRO CASTRO-RUZ, was,
JUAN MANUEL MARQUEZ

b3
b7E

[redacted]

(OO:NY)

Re report of SA [redacted] dated 6/19/57, at Miami, requesting WFO to check Central Office, INS, for last departure and destination of subject, JUAN MANUEL MARQUEZ.

b6
b7C

On 7/2/57, SE [redacted] obtained from the Central Office, INS, Washington, D. C., a photostat of the Non-Immigrant Visa and Alien Registration Card of JUAN MANUEL MARQUEZ, which contained the following information:

b6
b7C

Name	JUAN MANUEL RODRIQUEZ
Home Address	Luisa Quijano #508, Marianao, Cuba
Date of Birth	July 5, 1915 Habana, Cuba
Address in U.S.	Hotel Cortex Miami, Florida
Nearest Relative	[redacted]
Travel Document	Cuban Passport #18684; 8/7/53 to 8/5/58
Race	White
Hair	Brown
Height	5' 7"
Nationality	Cuban
Complexion	Fair
Marital Status	Married
Occupation	Constructor
Purpose of Trip	Pleasure (1 month)
Arrived	PAA FLT. 502, July 19, 1956
Date to Which	August 19, 1956
Admitted	

b6
b7C

[redacted] Searched _____
 [redacted] Serialized _____
 [redacted] Indexed _____
 [redacted] Filed _____

The above card did not list the date of departure or the destination of the subject. RUC.

b3
b6
b7C
b7E

2 = Bureau [redacted] (RM)
1 = New York [redacted] (RM)
1 = Miami [redacted] (info) (RM)
1 = WFO [redacted]

(6)

RUC

[redacted]

Rebels' Leader Predicts Batista's Fall by April 15

By Charles Schuman
HAVANA, March 30 (AP) — Cuban rebel leader Fidel Castro predicted to this correspondent that the Government of President Fulgencio Batista



United Press

Fidel Castro, leader of rebel forces in Cuba, carries his supper with him in Oriente Province. A Sierra Maestra farmer, who supports the 26th of July Movement, gave the chicken to Castro as he marched through a small town.

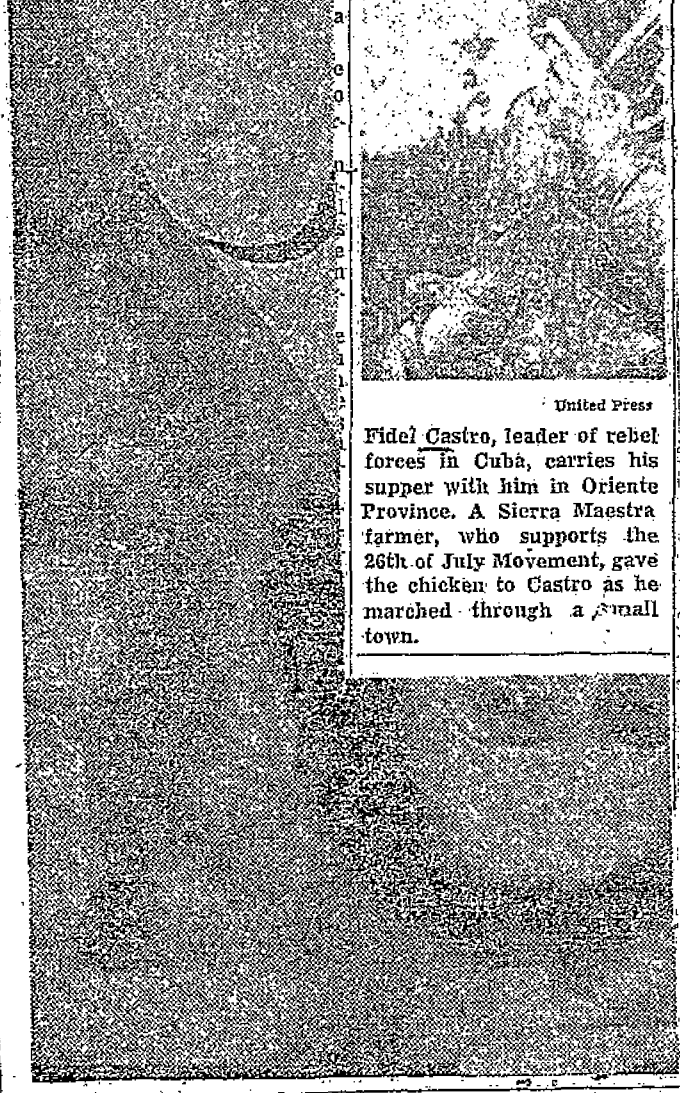

and Times Herald guaranteed home delivery.

"Will Be Different"

"This one will be different," he said.

"While I have been fighting in the Sierras the civilian arm of the 26th of July Movement has been busy laying plans for the strike in the cities.

"All segments of the population are behind us, according to the reports I get. Not labor alone, but doctors and lawyers and students and shopkeepers as well. Just about everybody. And when the strike comes, the Government will be helpless.

"Even Batista's soldiers, trained as they are in bloodletting, cannot kill a whole population."

Castro's organization is called the 26th of July Movement because on that date in 1953 he led a group of 80 students in an attack on the Moncada army barracks in Santiago de Cuba, capital of Oriente Province. The attack failed and Castro spent a period in exile, reorganizing his movement.

Deadline for Troops

Castro said flatly that many Batista soldiers would join his troops "when the time comes." He has given them until April 5 to join him or be marked as "traitors."

"Batista no longer controls his army," Castro said. "He controls only the top brass in the army."

He said he realized he was going out on a limb predicting a quick victory but "that's how the picture looks to me, based on the information I get."

Castro said there was no chance of a negotiated peace now.

"I would speak with Batista only to sign his articles of surrender," Castro said. "He is a gangster and a criminal."

Castro emphasized that he did not plan to assume the presidency himself if he won the war and he said his movement planned no social changes.

"Let me make this clear—ours is a special kind of revolution," he said. "It is political, not social. It is not a revolution of class against class, but of all social classes

*Index
Fidel Castro
700 numbers*

WASHINGTON POST
& TIMES HERALD 3/31/58
PAGE A-5 Column 1

SEARCHED	INDEXED
SERIALIZED	FILED
MAR 31 1958	
FBI WASH DC	

b3
b6
b7C
b7E

Rebels' Leader Predicts Batista's Fall by April 15

By Charles Schuman
 HAVANA, March 30 (AP)—Cuban rebel leader Fidel Castro predicted to this correspondent that the Government of President Fulgencio Batista will fall by April 15 after a bloody civil war.

"Blood will flow in the streets within the next two weeks," the bearded, 31-year-old revolutionist said.

He made his statement in the course of two formal interviews and several informal conversations during 17 days I spent in and around the rebel mountain hideaway in eastern Cuba's Oriente Province.

Castro plans to open the final phase of his revolution by paralyzing transportation throughout Oriente Province starting Tuesday. He has threatened to embargo Cuba in "total war" unless Batista resigns by next Saturday.

Castro, who has been fighting a guerrilla war against Batista for nearly 16 months, predicted the Government would give in under the combined pressure of a general strike by the populace and a series of military attacks by his own small armed forces.

No. Date Firm

No precise date for the strike has been announced, but it is expected to begin during the first days of April.

Squatting on the ground at his camp in the Sierra Maestra range, Castro stroked his bushy brown beard, adjusted horn-rimmed glasses on his nose and took a deep puff on a cigarette.

"Batista is a master of repression," he said intently.

"He'll use soldiers against the strikers and blood will flow in the streets within the next two weeks—the blood of soldiers as well as that of bus drivers who refuse to work, shopkeepers who refuse to open their stores, of cooks and bakers and office workers."

Lean and hard from months of guerrilla fighting and mountain living, Castro stroked a chicken in his arms as he spoke.

"It will be a hard fight but the people are ready this time," he said.

"The revolution is at hand and the people of Cuba are willing to make any sacrifice to rid themselves of this tyrant they have been saddled with for so many years."

Batista Digs In

The Batista regime, for its part, is digging in to withstand what Castro calls "the final phase" of his campaign.

Batista has asked for emergency powers to declare martial law and impose a country-wide curfew. Congress is expected to give them to him Monday. He is gathering a list of employees and their home addresses so troops can be dispatched to the houses of those who heed the general strike call.

Castro's plan is to start the ball rolling in Oriente, easternmost of Cuba's six provinces and cradle of the revolution. He has called for a halt to all land transportation in Oriente starting Tuesday.

With Oriente as an example, he hopes that by the time the general strike is called the entire country will fall in with it.

He has given orders to his followers to shoot at any vehicle moving in the province after April 1.

Castro said the general strike attempted in Cuba last August failed because it lacked organization.



United Press

Fidel Castro, leader of rebel forces in Cuba, carries his supper with him in Oriente Province. A Sierra Maestra farmer, who supports the 26th of July Movement, gave the chicken to Castro as he marched through a small town.

against the Government against a small army group.

"Batista represents no social class or interest, only the bandits. Everybody in this country has felt the heavy hand of the Batista dictatorship."

I asked Castro if he was a Communist or if there were Communists in his movement.

"In all its program, the 26th of July Movement has nothing at all to do with communism," he said. "It is possible there are two or three persons in the movement with radical social ideas."

"In this world not every man thinks alike, and in any political movement there may be several Communists. As for myself, I am not at all a Communist."

Castro said he had "no personal ambitions."

"The movement wants magistrate Manuel Urrutia (now in exile in New York) as provisional president until new elections can be held," he said.

"I will remain in the movement which will be the guiding force in the interim government. I seek no material regard other than to satisfy my conscience that I have done my best to help bring democracy and prosperity to my country."

"Will Be Different"

"This one will be different," he said. "While I have been fighting in the Sierras the civilian arm of the 26th of July Movement has been busy laying plans for the strike in the cities."

"All segments of the population are behind us, according to the reports I get. Not labor alone, but doctors and lawyers and students and shopkeepers as well. Just about everybody. And when the strike comes, the Government will be helpless."

"Even Batista's soldiers, trained as they are in blood-letting, cannot kill a whole population."

Castro's organization is called the 26th of July Movement because on that date in 1953 he led a group of 80 students in an attack on the Moncada army barracks in Santiago de Cuba, capital of Oriente Province. The attack failed and Castro spent a period in exile reorganizing his movement.

Deadline for Troops

Castro said flatly that many Batista soldiers would join his troops "when the time comes." He has given them until April 5 to join him or be marked as "traitors."

"Batista no longer controls his army," Castro said. "He controls only the top brass in the army."

He said he realized he was going out on a limb predicting a quick victory but "that's how the picture looks to me, based on the information I get."

Castro said there was no chance of a negotiated peace now.

"I would speak with Batista only to sign his articles of surrender," Castro said. "He is a gangster and a criminal."

Castro emphasized that he did not plan to assume the presidency himself if he won the war and he said his movement planned no social changes.

"Let me make this clear—ours is a special kind of revolution," he said. "It is political, not social. It is not a revolution of class against class, but of all social classes."

Fidel Castro
Index
90

SEARCHED	INDEXED
SERIALIZED	FILED
MAR 31 1956	
FBI WASH. F. O.	

b3
 b6
 b7C
 b7E

Washington Post & Times Herald
Sunday, 4/6/58, Pg 45, Col 3

Francis L. McCarthy
HAVANA, April 5 (U.P.)—
The Cuban army chief of staff said tonight that a rebel group personally led by Fidel Castro has been "cut off" from his main force and is being pursued into the mountains of Oriente Province, the Castro stronghold.

Lt. Gen. Pedro Rodriguez Avila said "the saboteurs" operating in the eastern province have been "broken up" and that the body of troops led by Castro has been "isolated" with government forces hot in pursuit.

The announcement indicated a break in the otherwise Easter calm of the island where Castro has threatened "total war" in the "very near future" to overthrow the government of President Fulgenio Batista.

Havana Is Quiet

Havana was quiet throughout the day. Rodriguez Avila said Santiago de Cuba and Manzanillo, key cities in Oriente and prime rebel targets, were "completely quiet." No disturbances were reported elsewhere.

Castro has said he commands a fighting force of 2000 men in his 15-month-old campaign against the Batista regime which now appears reaching its climax.

There was belief his threatened "total war" would begin with a general strike, probably on Monday.

Rodriguez Avila said "totally misinformed" and false press reports had given the impression that Castro had been advancing on Santiago and Manzanillo.

Castro's rebel headquarters radio, in the Easter calm before the expected storm, appealed to women and workers to join him and die, if necessary, in the war he has promised to touch off.

Former Cuban President Ramon Grau San Martin gave his blessings to a general strike but was pessimistic about the outcome.

"I'm in favor of any legal means to oust the Batista Government," he said, "but I think the strike will fail because leaders of the Cuban Confederation of Labor are opposing it."

Labor Union Denounced

The rebel radio today denounced the confederation leaders and accused them of growing rich at the expense of workers.

[In Washington, a group of political exiles picketed the White House in a campaign to stop U. S. military and economic aid to Cuba and the Dominican Republic.

[They carried signs and banners protesting "illicit" arms shipments by Dominican strongman Rafael Trujillo to Batista.

[In a letter to President Eisenhower and Secretary of State John Foster Dulles, the Dominican and Cuban exiles said the arms were transported in five American-made C-47 airplanes.

They called it an "arrogant attempt" by Trujillo "to crush the Cuban people just as he crushed the Dominicans for 28 years."

In Miami, meantime Cuban air force men today flew three Cuban transport planes out of Miami where they had been stranded when their pilots refused to transport arms, the Associated Press reported. No flight was filed but it was assumed the planes returned to Havana.

[Three other C46 transports belonging to Expresso Aereo Interamericano remain in Miami. Local officials of the company have ordered them stored to prevent their being commandeered by the military pilots.]

b3
b6
b7C
b7E

SEARCHED	INDEXED
SERIALIZED	FILED
APR 6 1958	
FBI - W	F. O.

Washington Post & Times Herald
Sunday, 4/6/58, P. A5, Col 1 + 2

C

Group Led by Castro Is Reported 'Cut Off'



Associated Press

PRESIDENT BATISTA
... confident



Associated Press

FIDEL CASTRO
... pledges total war

b3
b6
b7C
b7E

[Redacted]	
SEARCHED []	INDEXED []
SERIALIZED []	FILED []
APR 6 1958	
FBI - WASH DC	

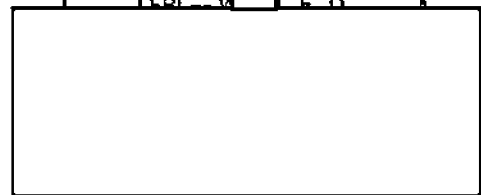

[Redacted]

SEARCHED	INDEXED
SERIALIZED	FILED
JUN 6 1958	
FBI - WAS. F. O.	

[Redacted]

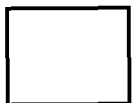

b3
b6
b7C
b7E

Date

11/5/58

SAC:

W. F. O.

Field Office

Re:

The enclosed is for your information. If used in a future report conceal all sources, paraphrase contents.

Enclosed are corrected pages from report of SA _____ dated _____

For information.

For appropriate action.

Remarks:

b3
b6
b7C
b7E

40

Enclosure(s)

[]

[]

SEARCHED	INDEXED
SERIALIZED	FILED
NOV 10 1958	

[]

[]

show news refer
2-0-66
Fidel Castro

Bullets Spray Castro's Home

HAVANA, Feb. 27 (AP)—Police reported gunfire from a passing car sprayed Fidel Castro's home tonight; but that no one was injured. The Premier was at the Palace at the time attending a Cabinet meeting.



b3
b7E

The Washington Post and
Times Herald.
Feb. 28, 59.
Sec. A. P. 1.

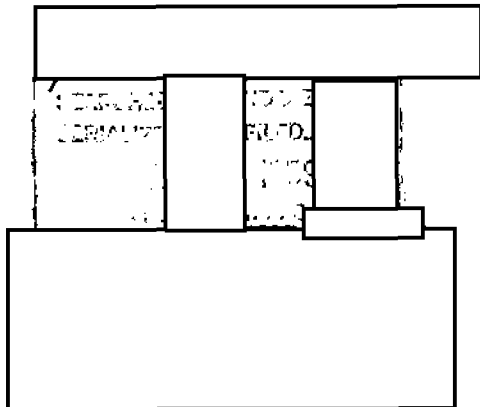

b3
b6
b7C
b7E

[Redacted]

SEARCHED [Redacted] INDEXED [Redacted]
SERIALIZED [Redacted] FILED [Redacted]
APR 2 1959
FBI - St. L. O.

[Redacted]

b3
b6
b7C
b7E

[Redacted]

FBI

Date: *March 31, 1959*

Transmit the following in _____
(Type in plain text or code)

Via Airtel _____
(Priority or Method of Mailing)

- To: SAC, Washington Field
- 2 - Havana (Enclosure)
 - 2 - Jacksonville (Enclosure)
 - 2 - Miami (Enclosure)
 - 2 - New York (Enclosure)
 - 2 - Ottawa (Enclosure)
 - 2 - San Juan (Enclosure)

From: Director, FBI [Redacted]

FIDEL CASTRO
[Redacted]

ReBulet to State 3/19/59.

Enclosed for each recipient is a copy of [Redacted]

The offices receiving this communication should be alert for any data indicating subversive or anti-Castro demonstrations which may be fomented and any data indicating a threat to Castro's personal safety or that of his group. Sources and informants in a position to acquire this data should be alerted to the necessity for prompt reporting. The Bureau should be promptly advised of any pertinent data received, and any indication of violence against Castro and members of his group should, in addition, be furnished local police officials.

Enclosure [Redacted]

b3
b7E

b3
b7E

b6
b7C

b3
b6
b7C
b7E

SEARCHED _____ INDEXED _____
 SERIALIZED _____ FILED _____
 APR 2 1959
 FBI WASH. F. O.

Sent Via _____ [Redacted]

Per [Redacted]

[Redacted]

SEARCHED [Redacted] INDEXED [Redacted]
SERIALIZED [Redacted] FILED [Redacted]

APR 7 1959

[Redacted]

[Redacted]

b3
b6
b7C
b7E

FBI

Date: 4-7-59

Transmit the following in _____
(Type in plain text or code)

Via Airtel _____
(Priority or Method of Mailing)

To: SAC, Washington Field (Enclosure)
2 - Newark (Enclosure)
2 - Boston (Enclosure)

From: Director, FBI [Redacted]

FIDEL CASTRO
[Redacted]

Re New York tel 4-3-59 captioned "Anti-Fidel Castro Activities." Enclosed for each office is a copy of [Redacted]

WFO immediately advise the local police authorities of the threat against Castro's life, as well as the information concerning the picketing being planned mentioned in retel.

For the information of Newark and Boston, retel reported that New York's source learned that there was allegedly a definite plan to kill Castro when he comes to the U.S. The source did not know where this attack would take place nor the identities of the participants. Since Castro plans to visit Newark and Boston areas, these offices will advise the appropriate local authorities of the threat to kill Castro while he is in the U.S.

The offices receiving this communication should be alert for any data indicating subversive or anti-Castro demonstration which may be fomented and any data indicating a threat to Castro's personal safety or that of his group. Sources and informants in a position to acquire this data should be alerted to the necessity for prompt reporting. The Bureau should be promptly advised of

- 1 - New York (Enclosure)
- 1 - Miami (Enclosure)
- 1 - Ottawa (Enclosure)
- 1 - Havana (Enclosure)

Handwritten signature

[Redacted]

SEARCHED _____ INDEXED _____
SERIALIZED _____ FILED _____
APR 7 1959
[Redacted]

b3
b7E

b3
b7E

b3
b6
b7C
b7E

*Airtel to Washington Field
Fidel Castro*

[REDACTED]

b3
b7E

*any pertinent data received and any indication of violence
against Castro and members of his group should, in addition,
be furnished local police officials.*

April 8, 1959

Airtel

To: SAC, New Orleans

- 2 - New York

From: Director, FBI

FIDEL CASTRO

Re New York airtel 4/6/59 which noted Castro plans visit to New Orleans 4/16/59.

For information of New Orleans, a New York source has learned that there is allegedly a definite plan to kill Castro when he comes to the U. S. The source did not know where this attack would take place nor the identities of the participants. Since Castro plans to visit New Orleans, New Orleans will immediately advise the appropriate local authorities of the threat to kill Castro while he is in the U. S.

New Orleans should be alert for any data indicating subversive or anti-Castro demonstrations may be fomented and any data indicating a threat to Castro's personal safety or that of his group. Sources and informants in a position to acquire this data should be alert to the necessity for prompt reporting. The Bureau should be promptly advised of any pertinent data received and any indication of violence against Castro and members of his group should, in addition, be furnished local police officials.

For information of New York any pertinent information relating to Castro's itinerary which differs from that in possession of NYC developed by the Bureau will be furnished NYC for referral to NYCPD. If the NYCPD has not already done so, it should be suggested that it contact the Department of State.

- 1 - Boston
- 1 - Miami
- ① - Washington Field

Make sure be advised of any security

SEARCHED	INDEXED
SERIALIZED	FILED
APR 7 1959	
FBI WASHINGTON	

b3
b6
b7C
b7E

b3
b6
b7C
b7E

4/6/59

PLAIN TEXT

AIRTEL

TO : DIRECTOR, FBI

FROM : SAC, NEW YORK ([redacted])

SUBJECT: FIDEL CASTRO
 ([redacted])

Handwritten: [redacted] [redacted] 4-3-59

b3
b6
b7C
b7E

The NY "Daily Mirror" of 4/3/59 contained an article stating that FIDEL CASTRO, Prime Minister of Cuba, had accepted an invitation to speak in NYC on 4/23/59 at a luncheon being given by the Overseas Press Club (OPC). This announcement was made by [redacted]

b6
b7C

The NY "Journal American" on 4/6/59 in the editorial by BOB CONSIDINE entitled, "On The Line" states that FIDEL CASTRO will visit Columbia University on 4/21/59, the UN on 4/22/59, the OPC luncheon on 4/23/59, and on the evening of 4/23/59 will attend a celebration given by the Cuban colony in NYC.

Detective [redacted] advised on 4/6/59 that he and Detective Sergeant [redacted] Bureau of Special Services, NYC PD, interviewed [redacted]

b6
b7C

- 3 - Bureau (RM)
- 1 - Boston (INFO) (RM)
- 1 - Miami (INFO) (RM)
- 1 - New Orleans (INFO) (RM)
- ① - Washington Field (INFO) (RM)
- 1 - New York [redacted]
- 1 - New York [redacted]

b3
b6
b7C
b7E

[redacted]
(10)

SEARCHED	INDEXED
SERIALIZED	FILED
APR 7 1959	
FBI - WASH. F. O.	

[Redacted]

b3
b6
b7C
b7E

[Redacted], NYC. [Redacted] stated that the latest itinerary for CASTRO during his visit to the US included the following:

4/16/59
New Orleans

4/17-20/59
Washington, DC

4/21/59
Leave Washington via train for Princeton University,
Princeton, NJ

4/21/59
Arrive NYC and go to Columbia University and
then visit to NY "Times"

4/22/59
UR (for ^{4 FOUR} an affair)

4/23/59
Luncheon, OPC (Astor Hotel)

4/23/59
Address council on Foreign Relations

4/24/59
Address Cuban colony at an armory or some other
appropriate location

[REDACTED]

4/25/59

Leave NYC en route to Boston, Mass.

[REDACTED] stated that while CASTRO is in the NY area he will stay in one of the Hilton hotels and in all probability will not be at the Waldorf-Astoria Hotel as Mrs. MARTA BATISTA is now there.

[REDACTED] stated that [REDACTED] was not too definite about the above itinerary and indicated that it was subject to a change at any moment.

Detective [REDACTED] also stated that he had made an inquiry at the Cuban Tourist Bureau at Rockefeller Center on 4/6/59 and was advised that CASTRO was expected to arrive in New Orleans, La., on 4/16/59 and then proceed to Washington for his official visit. [REDACTED] also stated that it was indicated that CASTRO would be travelling in his private plane to the US which is named "Sierra Maestra."

Lieutenant [REDACTED] Bureau of Special Services, NYC PD, is quite concerned over the planned visit of CASTRO to NYC. Lieutenant [REDACTED] desired to know whether or not the Bureau had any definite itinerary for CASTRO and whether or not any definite plans for appearances have been made as of this date.

[REDACTED]

The Bureau is respectfully requested to advise the NYO of any information received concerning CASTRO'S visit to the US and, in particular, in the NYC area in order that Lieutenant [REDACTED] of the Bureau of Special Services may be immediately advised ~~of~~ all security precautions ~~and~~ being taken by the NYC PD.

b3
b7E

b6
b7C

4/7/59

PLAIN TEXT

AIRTEL

TO : DIRECTOR, FBI

FROM : SAC, NEW YORK [redacted]

SUBJECT: FIDEL CASTRO [redacted]

Handwritten: C
[redacted]
[redacted] C.O.
[redacted] 4-3

b3
b6
b7C
b7E

ReNYairtel 4/5/59.

Detective [redacted] Bureau of Special Services, NYC PD, on 4/7/59, advised BSS received telephone call from [redacted] US State Department, NYC, who advised CASTRO'S itinerary in NY as follows:

b6
b7C

4/21/59
Columbia University (2:00 p.m. - 5:00 p.m.)
NY Times (5:30 p.m.)

4/22/59
UN - luncheon by UN correspondants (12:30 p.m. - 5:00 p.m.)

4/23/59
Overseas Press Club luncheon (12:30 p.m.)

b3
b6
b7C
b7E

- 3 - Bureau (RM)
- 1 - Boston (Info) (RM)
- 1 - Miami (Info) (RM)
- 1 - New Orleans (Info) (RM)
- 1 - Washington Field (Info) (RM)
- 1 - New York [redacted]
- 1 - New York [redacted]

[redacted] (#31)
(10)

[redacted]

SEARCHED	INDEXED
SERIALIZED	FILED
APR 8 1959	
F.O.	

[redacted]

b3
b7E

4/24/59
Celebration by Cuban colony, NYC
(no location as yet)

4/25/59
Leave NYC en route Boston, Mass.

[redacted] according to [redacted], said travelling
with CASTRO will be the following:

b6
b7C

[redacted]

b6
b7C

For information of Bureau and other offices, [redacted]
[redacted] is probably identical with [redacted]
[redacted] and [redacted] is probably
identical with [redacted] who is [redacted]
[redacted]

b6
b7C

[redacted]

b3
b6
b7C
b7E

[redacted] also stated that [redacted] said that threats had already been received against CASTRO'S life and that four State Department Agents from Washington, DC, will travel with CASTRO throughout the US. [redacted] stated that the US State Department has requested NYC to afford adequate security at all times for CASTRO'S party while in NYC and that NYC PD afford a lead and follow-up car for the motorcade while in NYC.

[redacted] further advised that all information has been furnished to Police Commissioner STEPHEN P. KENNEDY, NYC PD Commissioner, and that a special conference will be held by NYC PD to map out all arrangements concerning CASTRO'S trip.

b6
b7C

[Redacted]

b3
b7E

Date: April 6, 1959
To: Mr. H. Fomin Bailey
Director
Office of Security
Department of State
515 2nd Street, N. W.
Washington 25, D. C.

Post
[Redacted]

From: John Edgar Hoover, Director
Federal Bureau of Investigation

Subject: FIDEL CASTRO
[Redacted]

b3
b7E

A source who is in a position to furnish reliable information advised on April 3, 1959, that he had recently returned from Cuba.

With regard to the anticipated visit of Fidel Castro, Prime Minister of Cuba, to the United States on April 17, 1959, the source stated that [Redacted]

b6
b7C
b7D

[Large Redacted Block]

- 2 - Ottawa (See Note, Page 3)
- 1 - Havana
- ① - Washington Field

[Redacted]

SEARCHED	[Redacted]	INDEXED	[Redacted]
SERIALIZED	[Redacted]	FILED	[Redacted]
APR 8 1959			

[Redacted]

b3
b6
b7C
b7E

Mr. E. Tomlin Bailey

Another source who is in a position to furnish reliable information advised on April 2, 1959.



b6
b7C
b7D

The New York City Police Department has been advised of the alleged threat against Castro's life since Castro is expected to be in New York City on April 25, 1959.

The above is for your information.

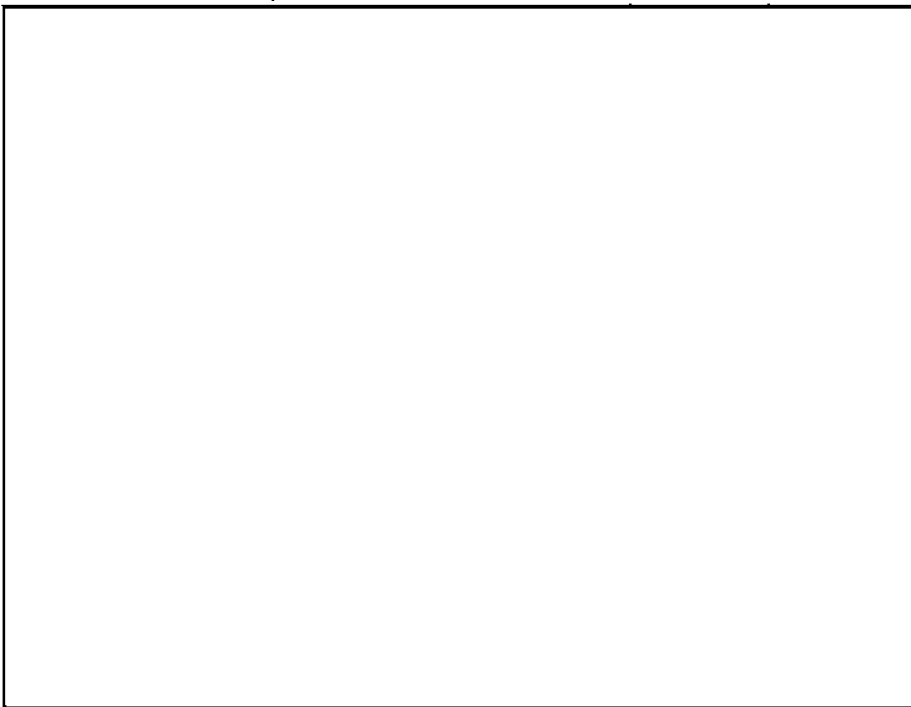

b3
b6
b7C
b7E

Mr. S. Tomlin Bailey

NOTE FOR LEGAL ATTACHES, OBTAINAS

Advice

b7D

F B I

Date: April 8, 1959

Transmit the following in _____
(Type in plain text or code)

Via AIRTEL _____
(Priority or Method of Mailing)

TO: SAC, Washington Field

✓ FROM: ✓ Director, FBI [redacted]

FIDEL CASTRO

[redacted]

[redacted] on 4/7/59 furnished the following information [redacted]

[Large redacted area]

- 1 - Boston
- 1 - New York
- 1 - New Orleans
- 1 - Miami
- 1 - Havana
- 1 - Ottawa
- 1 - Newark

[redacted]

SEARCHED.....	INDEXED.....
SERIALIZED.....	FILED.....
APR 10 1959	
FBI - WASH. F. O.	

[redacted]

b3
b7E

b3
b6
b7C
b7E

b3
b6
b7C
b7E

Sent Via _____ M Per _____

Airtel to Washington Field
Re: FIDEL CASTRO

[Redacted]

[Redacted]

b3
b6
b7C
b7E

[Redacted]

b3
b7E

Washington Field Office should immediately make
the foregoing information available to the local police
authorities in paraphrased form [Redacted]

[Redacted]

b3
b6
b7C
b7E

VPD
Capt. [Redacted]
Received 4/16/59
[Redacted]

Director, FBI [redacted]

April 1, 1959

Legat, Havana [redacted]

P.ell

b3
b7E

FIDEL CASTRO [redacted]

[redacted]

[redacted]

ReBulet March 19, 1959, to the State Department.

This office is attempting to ascertain the identities of the individuals who will accompany FIDEL CASTRO to the United States on his proposed trip on April 17, 1959. To date, only one individual has applied for a U. S. visa in connection with this trip, namely, [redacted]. The Bureau was advised concerning this by cable dated March 31, 1959, entitled [redacted].

b3
b6
b7C
b7E

It is to be noted that the U. S. Ambassador at staff conferences has advised that he intends consulting with the Cuban Ambassador to the United States, who is in Havana at the present time, to determine the identities of the individuals planning to accompany CASTRO and also to ascertain CASTRO's itinerary in the United States. The U. S. Ambassador to date has received no official word concerning these plans.

Two extra copies of this letter have been prepared in the event the Bureau desires to furnish them to the New York and Miami offices for information.

4 - Bureau (1-cc: New York
Miami)

1 - Havana

[redacted]

(5)

b3
b6
b7C
b7E

[redacted]

SEARCHED	INDEXED
SERIALIZED	FILED
APR 8 1959	

[redacted]

Date _____

SAC: WFO

X For Info.

[Redacted]	
SEARCHED	INDEXED
SERIALIZED	FILED
APR 8 1959	
[Redacted]	
[Redacted]	

b3
b6
b7C
b7E

FBI

Date: April 9, 1959

Transmit the following in _____
(Type in plain text or code)

Via Airtel _____
(Priority or Method of Mailing)

- To: SAC, Washington Field
- 2 - Boston
- 2 - Miami
- 2 - Newark
- 2 - New York
- 2 - New Orleans
- 2 - Ottawa

✓ From: Director, FBI [redacted]

FIDEL CASTRO

[redacted]

[Large redacted block]

An informant who has furnished reliable information in the past advised [redacted]

[redacted]

U.S. offices receiving this communication will immediately make this information available to the local police authorities. Do not identify source named above. Ottawa advise [redacted]

MPD advised 4/10/59

SEARCHED	INDEXED
SERIALIZED	FILED
APR 10 1959	
FBI WASH. F. O.	

Sent Via _____ M

b3
b7E

b6
b7C
b7D

b7D

b3
b6
b7C
b7E

April 9, 1959

Airtel

To: SAC, New York

From: Director, FBI

FRANK CASTRO

In connection with forthcoming visit of Castro to the U. S., it is noted he has made numerous statements of derogatory nature concerning current regime in the Dominican Republic and has encouraged Dominican exile groups to overthrow the Trujillo Government. Possibility exists that Dominican agents may attempt reprisals against Castro while he is in U. S.

All offices alert Dominican sources to promptly advise of any data received concerning Dominican-inspired action against Castro or his party. Furnish pertinent information received to Bureau immediately and, where warranted, local police authorities should also be immediately advised.

- 1 - Boston
- 1 - Chicago
- 1 - Miami
- 1 - New Orleans
- 1 - Newark
- 1 - Ottawa
- ① - Washington Field
- 1 - San Juan

advised #6

SEARCHED	INDEXED
SERIALIZED	FILED
APR 10 1959	
VI	

b3
b7E

b3
b6
b7C
b7E

[REDACTED]	
SEARCHED	INDEXED
SERIALIZED	FILED
APR 13 1959	
FBI - WASH. F. O.	
[REDACTED]	

b3
b6
b7C
b7E



April 10, 1959

AIRTEL

TO: 540, Washington Field
2 - Boston (Enclosure)
2 - Miami (Enclosure)
2 - Newark (Enclosure)
2 - New York (Enclosure)
2 - New Orleans (Enclosure)

From: Director, FBI [redacted]

FRED SAUNDERS
[redacted]

b3
b7E

Enclosed for each office is a copy of [redacted]
[redacted]

All offices will note the information contained therein to the effect that Cuban exiles in New York and Washington are planning to spoil Castro's trip to the United States, and that certain persons are hiring Nicaraguans, Puerto Ricans and Cubans to provoke incidents against Castro. All offices will also note the names of the persons listed on page two of the enclosed communication who are named as leaders in provoking unfavorable demonstrations against Castro.

All offices will immediately advise the Bureau of any information received concerning this matter particularly on the part of the specific persons named in the enclosure.

Enclosure

1 - Newark (Enclosure)

b3
b6
b7C
b7E

[redacted]

SEARCHED	INDEXED
SERIALIZED	FILED
APR 13 1959	
FBI - WASH. F. O.	

[redacted]

4/10/59

AIRTEL

TO: DIRECTOR, FBI [redacted] (RM)

FROM: SAC, BOSTON [redacted]

FIDEL CASTRO
[redacted]

Public
[redacted]

b3
b6
b7C
b7E

Re Bureau airtel 4/7/59.

On April 9, 1959, [redacted] Harvard Law School, Cambridge, Mass., advised CASTRO visiting Harvard at invitation of Harvard Law School Forum, a student organization. Invitation to CASTRO was extended by [redacted] a Harvard Law School student on behalf of the Harvard Law School Forum.

b6
b7C

[redacted] stated he will meet with CASTRO as personal representative of Harvard University at Hotel Statler, New York City, on April 24, 1959 and expects to leave New York with CASTRO and group morning April 25, 1959, estimated arrival at Boston noon time, April 25, 1959. CASTRO and party will stay overnight at Ritz-Carlton Hotel, Boston, Mass. and depart Boston April 26, 1959. [redacted] stated reportedly CASTRO and group will have 15 radio, television and newspaper men from Cuba, 13 members of CASTRO's government and 6 Cuban Army guards.

b6
b7C

[redacted] Harvard University Marshal, advised on April 10, 1959 that FIDEL CASTRO is not a guest of Harvard University. [redacted] stated [redacted] Harvard Law School student, invited CASTRO to address the Harvard Law School

b6
b7C

- 3 - Bureau [redacted] (RM)
- 1 - Miami (RM)
- 1 - Newark (RM)
- 1 - New Orleans (RM)
- 1 - New York (RM) [redacted]
- 1 - WFO (RM) [redacted]
- 1 - Boston [redacted]

b3
b6
b7C
b7E

[redacted]
(9)

SEARCHED	INDEXED
SERIALIZED	FILED
APR 13 1959	

April 10, 1959

PLAIN TEXT

AIR TEL - AIR MAIL

To: Director, FBI

From: SAC, New Orleans [redacted]

Re: FIDEL CASTRO
[redacted]

Full

b3
b6
b7C
b7E

Re: airtel to New Orleans and New York 4/8/59, and New York airtels to Bureau 4/6/59 and 4/7/59, entitled as above. Re New Orleans letter to Bureau 4/8/59 entitled "ANTI-FIDEL CASTRO ACTIVITIES, [redacted]"

b3
b7E

PROVOSTY A. DAYRIE, Superintendent, New Orleans Police Department, was advised 4/10/59 by SA [redacted] that FIDEL CASTRO is alleged to have New Orleans on his itinerary of his visit to the United States, with scheduled arrival in New Orleans on April 16, 1959. DAYRIE was advised that there is allegedly a definite plan to kill CASTRO when he comes to the United States, but that the source of this information was not aware where this attack would take place, nor the identities of the participants.

b6
b7C

DAYRIE stated that he has not received any data regarding the impending arrival of CASTRO in New Orleans, nor has he received any request for police protection, and that in the absence of such a specific request, without any specific knowledge of the exact time or place of arrival of CASTRO, that no efforts would be made by him to have police guard present upon CASTRO's arrival.

The Bureau's attention is respectfully directed to

- 3 - Bureau [redacted] (AM - Registered)
- 1 - New York (Info) [redacted] (AM - Registered)
- 1 - Miami (Info) (AM - Registered)
- 1 - Washington Field Office (Info) (AM - Registered)
- 1 - Boston (Info) (AM - Registered)
- 2 - New Orleans

b3
b6
b7C
b7E

[redacted]
[redacted]

SEARCHED	INDEXED
SERIALIZED	FILED
APR 13 1959	

[REDACTED]

b3
b7E

referenced New Orleans letter entitled "ANTI-FIDEL CASTRO ACTIVITIES, [REDACTED] concerning the invitation extended to FIDEL CASTRO to speak before a meeting of the Optimist Club in New Orleans on 4/15 or 4/16/59.

As of 4/10/59, [REDACTED] (PROTECT IDENTITY) has advised that [REDACTED]

b6
b7C
b7D

Sources at New Orleans have been alerted for any data indicating subversive or anti-Castro demonstrations which may be fomented and any data indicating a threat to CASTRO's personal safety or that of his group. If such information is received, New Orleans will immediately advise the Bureau and appropriate offices.

New Orleans has also alerted Immigration & Naturalization Service authorities at New Orleans to advise of any information in their possession, or which they may receive, relative to the arrival of CASTRO and his group in the area of the New Orleans Division via CASTRO's personal plane or by other mode of travel.

[REDACTED]

b6
b7C

FEDERAL BUREAU OF INVESTIGATION
U. S. DEPARTMENT OF JUSTICE
COMMUNICATIONS SECTION

C

APR 13 1959

[REDACTED]

TELETYPE

b6
b7C

URGENT 4-13-59 7-29 PM [REDACTED]

TO DIRECTOR, FBI 4 AND SAC, WASHINGTON FIELD
FROM SAC, NEW YORK 5P

b3
b6
b7C
b7E

FIDEL CASTRO, [REDACTED] DETECTIVE [REDACTED]

NYCPD, ADVISED HE AND LIEUTENANT [REDACTED] MET

WITH [REDACTED] NYC, THIS

DATE. [REDACTED] STATED ALSO PRESENT AT THIS MEETING IN

CONNECTION WITH CASTRO-S VISIT TO US WERE [REDACTED]

b6
b7C

[REDACTED]

[REDACTED] AND

[REDACTED] STATED THAT ALSO IN NY AT THE PRESENT

TIME IS [REDACTED]

b6
b7C

AND THE MAN IN CHARGE OF THE SECURITY FOR CASTRO-S VISIT TO
THE US, WHO IS NOW IN NYC. [REDACTED] THAT THEY WERE MUCH

CONCERNED OVER CASTRO-S TRIP TO THE US AS THEY HAVE INFORMATION
THAT THERE IS A PLOT TO ASSASSINATE CASTRO WHO IS IN NYC.

END PAGE ONE

SEARCHED [REDACTED] INDEXED [REDACTED]
SERIALIZED [REDACTED] FILED [REDACTED]

b3
b6
b7C
b7E

APR 13 8 45 PM '59

FBI-WASH. F. O.

BUREAU ADVIS [REDACTED]
[REDACTED]

[REDACTED]

PAGE TWO

[REDACTED] STATED THAT [REDACTED]

[REDACTED]

b6
b7C
b7D

[REDACTED] FURTHER

STATED, ACCORDING TO [REDACTED] THAT [REDACTED]

[REDACTED]

[REDACTED] SEVERAL DAYS AGO. [REDACTED]

[REDACTED] ON APRIL THIRTEEN, INSTANT, STATED THAT
IN CONNECTION WITH ANOTHER INVESTIGATION THEY HAD ASCERTAINED
THAT [REDACTED]

b6
b7C
b7E

END PAGE TWO

PAGE THREE

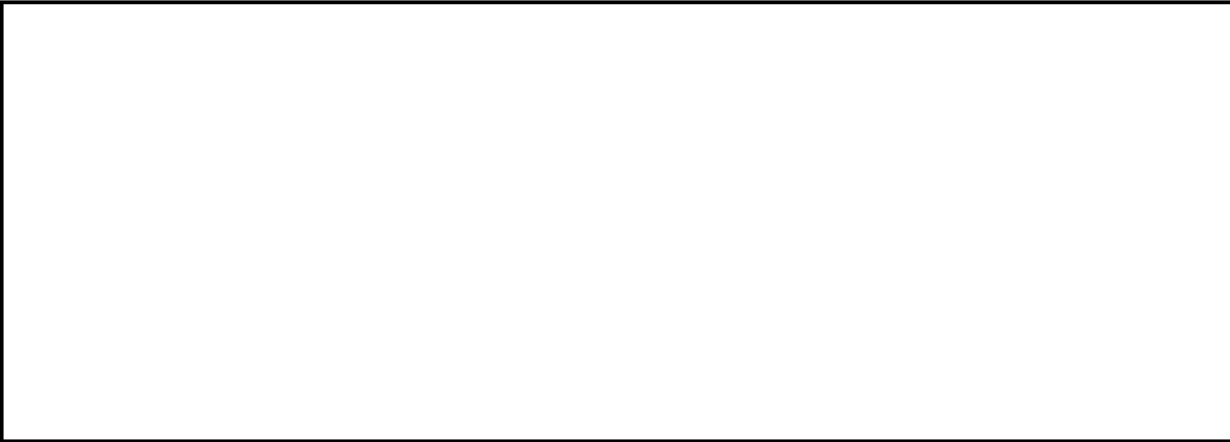

b6
b7C
b7E

[Redacted] ADVISED THAT [Redacted]

b6
b7C
b7D



[Redacted] ADVISED THAT [Redacted]

b6
b7C
b7D



END PAGE THREE

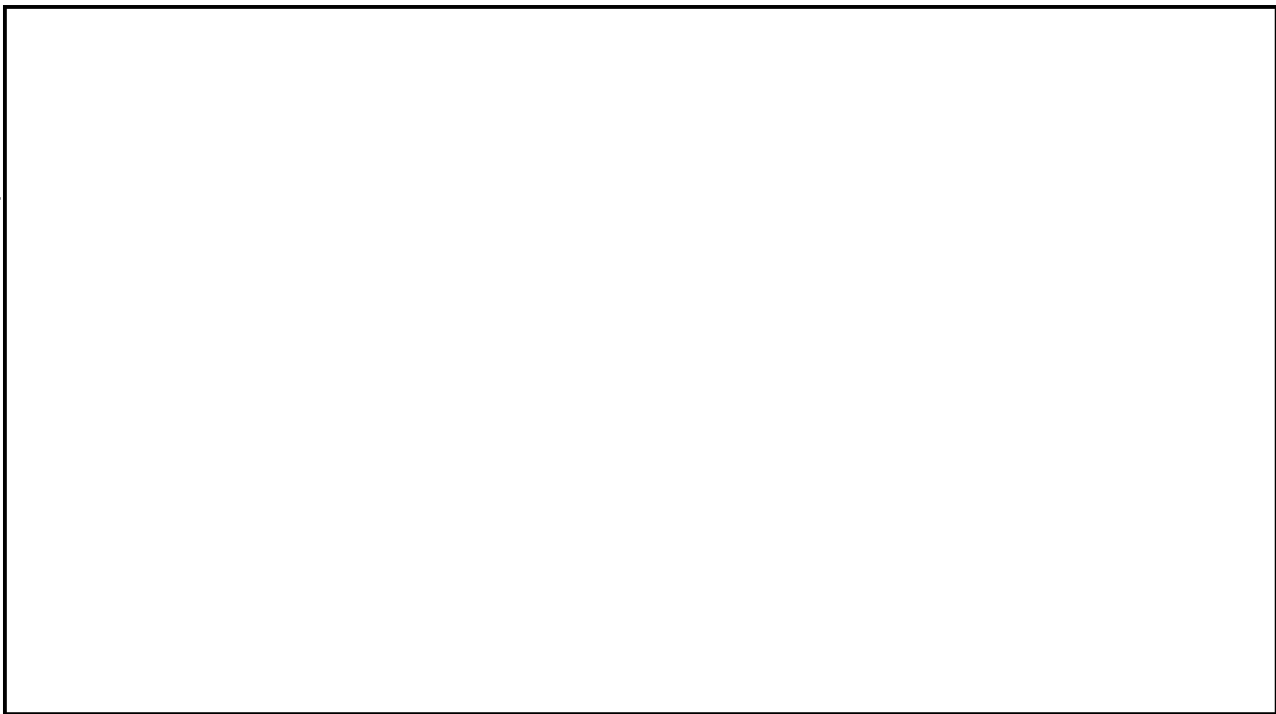

b6
b7C
b7D

[REDACTED] ADVISED THAT THE CELEBRATION PLANNED BY THE CUBAN COLONY FOR CASTRO FOR APRIL TWENTY FOUR, NEXT, HAS NOT YET DECIDED ON A PLACE. [REDACTED] SAID THAT THEY CANCELLED THE RESERVATION ON THE THIRTY FOUR STREET ARMORY BECAUSE IT ONLY HAD A CAPACITY OF TEN THOUSAND. [REDACTED] STATED THAT THEY WERE ATTEMPTING TO GET MADISON SQUARE GARDEN, BUT IF THEY CANNOT BECAUSE OF THE CIRCUS, THEY WILL THEN HAVE THE CELEBRATION IN
END APGE FOUR

b6
b7C

PAGE FIVE

CENTRAL PARK MALL. [] STATED THAT CASTRO IS PREPARED TO
SPEAK FOR SIX FOR SEVEN HOURS TO THE CUBAN COLONY AT THIS
CELEBRATION. [] ADVISED THAT THE NYO WILL BE KEPT
ADVISED OF ANY ADDITIONAL INFORMATION REGARDING THIS PLOT TO
ASSASSINATE CASTRO AND ANY CHANGES IN CASTRO-S ITINERARY.
MAIL COPIES SENT BOSTON, MIAMI, NEW ORLEANS, NEWARK, SAN JUAN.

END AND ACK PLS

R NY 4 WA CRA

TP

b6
b7c

Director, FBI [redacted]

April 7, 1959

b3
b7E

Legat, Havana [redacted]

FIDEL ALBANDRO CASTRO RUZ
[redacted]

[redacted] advised on April 6, 1959,

[Large redacted block]

b3
b6
b7C
b7E

Extra copies of this letter have been prepared for forwarding by the Bureau to the Washington Field office.

4 - Bureau (2-cc: WFO)

1 - Havana
[redacted]

(5)

b6
b7C

[redacted]

b3
b6
b7C
b7E

[redacted]

[redacted]

Date _____

SAC: WFO

Legal Attache: _____

Re:

The enclosed is for your information. If used in a future report conceal all sources, paraphrase contents.

Enclosed are corrected pages from report of SA _____ dated _____

For information.

For appropriate action.

Remarks:

[Redacted]

SEARCHED	INDEXED
SERIALIZED	FILED
APR 14 1959	

[Redacted]

b3
b6
b7C
b7E

Enclosure(s)

FBI

Date: 4-14-59

Transmit the following in _____
(Type in plain text or code)

Via Airtel _____
(Priority or Method of Mailing)

To: SAC, WFO
✓ From: Director, FBI [redacted]
FIDEL CASTRO
[redacted]

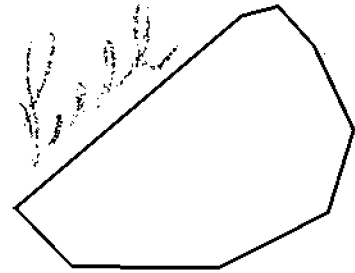

Enclosed for your information is a copy of
[redacted]
[redacted]

Enclosure

b3
b6
b7C
b7E

b3
b7E

[redacted]

b3
b6
b7C
b7E

SEARCHED [] INDEXED []
SERIALIZED [] FILED []
APR 17 1959
[redacted]

Sent Via _____

Per _____



FBI

Date: 4-15-59

Transmit the following in _____
(Type in plain text or code)

Via Airtel _____
(Priority or Method of Mailing)

To: SAC, WFO - Enclosures (4)
2 Boston - Enclosures (4)
2 Miami - Enclosures (4)
2 Newark - Enclosures (4)
2 New York - Enclosures (4)
2 New Orleans - Enclosures (4)
2 Houston - Enclosures (4)

From: Director, FBI [redacted]

FIDEL CASTRO
[redacted]

ReBuairtel 4-9-59 to WFO and Buairtel to Houston dated 4-14-59. Information was contained in the referenced communications indicating that [redacted]

The source who furnished the information has [redacted]

One copy of each of these photographs should be made available to the local police department.

For your additional information, information from [redacted]

b3
b7E

b6
b7C
b7D

b6
b7C
b7D

b3
b6
b7C
b7E

SEARCHED	INDEXED
SERIALIZED	FILED
APR 17 1959	
[redacted]	
[redacted]	

Sent Via _____ M

Per _____

April 15, 1959

AIRTEL

TO: DIRECTOR, FBI [redacted]

b3
b7E

FROM: SAC, WFO [redacted]

FEDEL CASTRO RUZ
[redacted]

For the information of the Bureau, all pertinent information received by WFO from the Bureau, auxiliary offices and informant coverage has been furnished to the Metropolitan Police Department, Washington, D. C. (MPD) and [redacted] in light of information set forth below indicating security responsibility within grounds Mount Vernon, Virginia, will lie with Fairfax County Police Department, this police department will be advised generally of alleged plot for assassination of CASTRO.

On 4/15/59 Captain [redacted] Special Services Squad, MPD, furnished following to SA [redacted]

b6
b7C

Regarding security measures to be taken concerning CASTRO, a State Security cruiser will be manned by a [redacted] of the State Security Office and two MPD detectives who speak Spanish and who will mingle with CASTRO crowd to pick up any information of value. These detectives are [redacted]

b6
b7C

According to [redacted] ten men from the State Security Office will be assigned as security detail.

b3
b6
b7C
b7E

- 3 - Bureau
- 1 - Miami (Info)(RM)
- 1 - New York (Info)(RM)
- 1 - Richmond (Info)(RM)
- 1 - WFO

[redacted] [redacted]

[redacted]
(7) [redacted]

A I R T E L

[redacted]

Searched _____
Serialized _____
Indexed _____
Filed _____

[redacted]

MPD Cruiser [redacted] will be manned by Detectives [redacted] They will travel with CASTRO at all times, including Embassy functions.

MPD Cruiser [redacted] will be manned by Captain [redacted] and Lieutenant [redacted]

Ten uniformed MPD officers will be stationed at buildings wherein CASTRO will appear, including Embassy, in out of way places to avoid entrance by undesirable persons.

At CASTRO's appearance on "Meet the Press" and "Face the Nation" two additional detectives and 50 additional uniformed officers will be on duty.

[redacted] advised that CID will have 80 men assigned to security detail for CASTRO.

The Park Police will convoy CASTRO from National Airport to ~~White House~~ and to Mount Vernon on 4/19/59.

Chief of Park Bureau [redacted]

Liaison established with Captain [redacted] whereby he will keep WFO advised constantly and on the spot concerning happenings during CASTRO visit. WFO to take no active participation in security measures.

Lieutenant [redacted] Park Police, advised that security of CASTRO at National Airport being supplemented by military. Stated Park Police will detail six men to cover route from Airport to Washington, D. C., including coverage of bridges. Will also maintain coverage on trip to Mount Vernon; however, security within grounds of Mount Vernon will lie with Fairfax County Police Department. Park Police will also provide security, supplemented by MPD officers, at Meridian Hill Park (vicinity of Cuban Embassy), Jefferson and Lincoln Memorials.

On 4/15/59 pursuant to Bureau authority. SAs

[redacted] PSI
[redacted] PSI indicated [redacted]

Shortly after physical contact PSI telephonically advised SA [redacted] of following and stated he would attempt to enlarge on this information and would keep WFO advised on current basis.

b3
b6
b7C
b7E

b6
b7C

b6
b7C

b6
b7C
b7D

[redacted]

[redacted]

b3
b6
b7C
b7D
b7E

Captain [redacted] interviewed [redacted] at MPD this date and was advised that 200 anti-CASTRO people to be brought Washington, D. C., from New York City 4/17/59 at instigation of [redacted]. After picketing Washington, D.C., this group will return New York City 9:00 P.M. 4/17/59. This group to be led by [redacted]

b6
b7C

[redacted] whose identities are known to the Bureau. [redacted] also ascertained from [redacted] that 150 pro-CASTRO people to arrive Washington, D. C., 5:00 P.M. 4/15/59 from New York City to picket at Statler Hotel and then at the Washington National Airport.

It is noted that contact is had with [redacted] twice daily by SA [redacted] and more frequently in the event informant has information of value. On 4/15/59 informant learned [redacted]

b6
b7C
b7D

*

[redacted]

According to informant, [redacted]

[redacted]

b6
b7C
b7D

Informant also stated [redacted]

[redacted]

*

[redacted]

b7D



b3
b7E

Information received from above sources will be furnished the Bureau on a daily basis.

Information ascertained from different sources of value to other agencies is being submitted in a form suitable for dissemination.

April 14, 1959

Airtel

To: SAC, Houston

From: Director, FBI [redacted]

FIDEL CASTRO [redacted]

b3
b6
b7C
b7E

The Washington Capital News Service on 4/11/59 reported the following:

"Houston-- [redacted] said today Revolutionary Frontier Fidel Castro of Cuba has tentatively accepted an invitation to visit Houston about April 25.

b6
b7C

[redacted] said the Cuban leader is expected to spend two days in Houston during his tour of the United States and Canada. He was invited here by the Houston Junior Chamber of Commerce."

For the information of Houston, a New York source has learned that there is allegedly a definite plan to kill Castro when he comes to the U. S. The source did not know where this attack would take place nor the identities of the participants.

Enclosures - 2

- 1 - Boston
- 1 - Miami
- 1 - Newark
- 1 - New Orleans
- 1 - New York
- ① - Washington Field

[redacted]	
SEARCHED [redacted]	INDEXED [redacted]
SERIALIZED [redacted]	FILED [redacted]
APR 15 1959	
[redacted]	

b3
b6
b7C
b7E

Airtel to SAC, Houston
Re: FIDEL CASTRO

[Redacted]

b3
b7E

Enclosed for Houston is one copy each of the following:

- (1) Bulet to State Department 4/9/59.
- (2) [Redacted]

Houston will immediately furnish the information given by the New York source and the information in Bulet to State 4/9/59, both referred to above, to local police authorities.

Houston should be alert for any data indicating subversive or anti-Castro demonstrations may be fomented and any data indicating a threat to Castro's personal safety or that of his group. Sources and informants in a position to acquire this data should be alerted to the necessity for prompt reporting. The Bureau should be promptly advised of any pertinent data received and any indication of violence against Castro and members of his group should in addition be furnished local police authorities.

[Redacted] is for your information.

b3
b7E

SEARCHED	INDEXED
SERIALIZED	FILED
APR 15 1959	
FBI - WASHINGTON	

b3
b6
b7C
b7E

FEDERAL BUREAU OF INVESTIGATION
U. S. DEPARTMENT OF JUSTICE
COMMUNICATIONS SECTION

APR 14 1959

TELETYPE

b6
b7C

URGENT 4-14-59 7-04 PM [redacted]

TO DIRECTOR, FBI 2 AND SAC, WASHINGTON FIELD

FROM SAC, NEW YORK 2P *fulled* [redacted]

b3
b6
b7C
b7E

FIDEL CASTRO, [redacted] RENVTEL APRIL FOURTEEN, INSTANT.

DETECTIVE [redacted] BSS, NYCPD, ADVISED APRIL FOURTEEN,

INSTANT, THAT THEY HAS SPOKEN TO [redacted]

[redacted] WHO ADVISED THAT

MORE THAT TWO HUNDRED FIFTY DOMINICANS OPPOSED TO FIDEL CASTRO

WILL LEAVE NYC FROM [redacted] VIA

GREYHOUND BUS TO PICKET CASTRO IN WASHINGTON, D.C., ON APRIL

SEVENTEEN. NEXT. CONTRACT FOR SIX BUSES AT GREYHOUND LINES WAS

MADE PER [redacted] AT COST OF THREE HUNDRED SEVENTEEN DOLLARS

b3
b6
b7C
b7E

AND THIRTY CENTS PER BUS AND [redacted] INDICATED THAT POSSIBLY

MORE BUSES MAY BE NEEDED. [redacted] STATED THAT [redacted] SAID THAT

~~CORR LINE NINE WORD FOUR SHLD BE [redacted]~~

END PAGE ONE

SEARCHED [redacted] INDEXED [redacted]
SERIALIZED [redacted] FILED [redacted]

APR 15 12 00 AM '59

FBI-WASH. F. O.

b3
b6
b7C
b7E

PAGE TWO

✓ THESE PICKETS WOULD DEMONSTRATE OUTSIDE OF HOTEL IN WASHINGTON,
D.C., WHERE CASTRO ADDRESSES ASNE GROUP. [REDACTED] FURTHER STATED
THAT THEY HAD SPOKEN TO [REDACTED] PAN
AMERICAN ANTI DASH COMMUNIST ASSOCIATION, WHO ADVISED THAT HE
WAS TAKING APPROXIMATELY ONE HUNDRED PICKETS TO WASHINGTON,
D.C., ON APRIL SEVENTEEN, NEXT, TO PICKET CASTRO. [REDACTED]
FURTHER STATED THAT DURING CASTRO-S VISIT TO NYC HIS GROUP
INTENDS TO PICKET CASTRO EVERY DAY AND AS MUCH AS POSSIBLE
DURING HIS NYC VISIT. [REDACTED] ALSO INDICATED THAT CASTRO-S
SYMPATHIZERS MAY PROVOKE A BAD INCIDENT DURING CASTRO-S VISIT
TO US AND MOST PROBABLY THIS INCIDENT WILL TAKE PLACE IN NYC.
MAIL COPIES SENT BOSTON, MIAMI, NEWARK, NEW ORLEANS, AND SAN JUAN.
END AND ACK PLS
NY R 2 WA WS
TU¹₄

b6
b7c

FEDERAL BUREAU OF INVESTIGATION
U. S. DEPARTMENT OF JUSTICE
COMMUNICATIONS SECTION

e

APR 14 1959

TELETYPE

URGENT 4-14-59 11-22 PM [redacted]

TO DIRECTOR, FBI 4 AND SAC, WASHINGTON FIELD

FROM SAC, NEW YORK 5P [redacted]

SUBJECT, FIDEL CASTRO, [redacted]. RNYTEL FOUR THIRTEEN FIFTYNINE.

AT INVITAION OF CAPT. [redacted]

[redacted] TO FIDEL CASTRO, [redacted] WAS INTERVIEWED

IN HIS SUITE AT THE SHERATON HILTON ON NIGHT OF FOUR THIRTEEN FIFTYNINE.

[redacted] WAS WITH [redacted] WHO FORMERLY WAS

TWO OTHER UNIDENTIFIED CUBANS. [redacted] STATED

THAT IN REGARD TO THE ATTEMPT TO ASSASSINATE CASTRO DURING

HIS VISIT TO US, THEY BELIEVE THAT THE MAN MOST CAPABLE

OF DOING THIS WAS [redacted]

[redacted] ALSO STATED THAT OTHER INDIVIDUALS

WHOM THEY WOULD SUSPECT WOULD INCLUDE /FNU/ [redacted] WHO IS

CLOSE TO [redacted]

WHO HAD WORKED FOR [redacted] IN HAVANA.

[redacted] ALSO STATED THAT OTHER INDIVIDUALS

WHO ARE OPPOSED TO CASTRO AND MAY SEEK TO DO HARM TO

CASTRO ARE [redacted] FROM THE CUBAN GOVERNMENT HAS

END PAGE ONE

SEARCHED [redacted] INDEXED [redacted]
SERIALIZED [redacted] FILED [redacted]

APR 15 12 00 AM '59

FBI-WASH. F. O.

b3
b6
b7C
b7E

b6
b7C

b6
b7C

b6
b7C

b6
b7C

b3
b6
b7C
b7E

BUREAU ADVISED

PAGE TWO

BRANDED AS A TRAITOR, [REDACTED]

[REDACTED]
AND [REDACTED]

[REDACTED] AND WHO IS BELIEVED TO BE WITH [REDACTED] IN NYC.

[REDACTED] STATED THAT THEY HAD ALSO ASCERTAINED

THAT PICKETS WERE BEING SENT IN CHARTERED BUSES FROM NY
TO WASHINGTON, D.C. AND THAT THIS GROUP INCLUDED
DOMINICANS AND CUBANS, WHO WERE BEING PAID FIFTY DOLLARS A DAY
TO PICKET CASTRO AND THAT THESE PICKETS WERE HIRED BY

[REDACTED] WHO WAS WORKING WITH [REDACTED]

[REDACTED] ALSO STATED THAT THEY HAD

HEARD THAT FORMER BRIGADIER GENERAL FRANCISCO "CILITO"
TABERNILLA HAD HIRED PICKETS TO GO TO WASHINGTON, D.C.
AND NYC AT A COST OF ONE HUNDRED PER DAY.

[REDACTED] STATED THAT THEY HAD NO

FURTHER DETAILS REGARDING AN ALLEGED PLOT ON PART OF
END PAGE TWO

b6
b7C

b6
b7C

b6
b7C

PAGE THREE

[REDACTED] AND OTHERS TO ASSASSINATE CASTRO DURING HIS VISIT TO US, BUT STATED THAT IF THEY RECIEVE ANY ADDITIONAL INFORMATION THEY WOULD NOTIFY THE NYCPD AND THE NYO.

b6
b7C

[REDACTED] WERE INTERVIEWED BY DETECTIVE [REDACTED] [REDACTED] BSS, NYCPD, AND SA [REDACTED] OF NYO.

b6
b7C

DETECTIVE [REDACTED] ON FOUR FOURTEEN FIFTYNINE, ADVISED THAT HIS OFFICE RECEIVED TELEGRAM FROM METROPOLITAN PD CONCERNING PICKETS ARRIVING FROM NY. [REDACTED] STATED AT ONE THIRTY AM, FOUR FOURTEEN FIFTYNINE, MEMBERS OF BSS WENT TO [REDACTED]

[REDACTED] AND INTERVIEWED INDIVIDUALS PRESENT, WHO INCLUDED THE FOLLOWING... [REDACTED]

b6
b7C

CORR LINE 17 LAST WORD SHLD BE "THREE"

END PAGE THREE

PAGE FOUR

HIM. [REDACTED] STATED THAT [REDACTED] ACTED AS SPOKESMAN FOR THE ABOVE GROUP, WHO ALL LIVED IN A SMALL APARTMENT AT A PRIVATE HOME AT [REDACTED]

b6
b7c

CLAIMED THEY HAD NO FIREARMS AND CONSENTED TO A SEARCH OF THE APARTMENT, WHICH WAS NEGATIVE.

[REDACTED] DENIED ANY KNOWLEDGE OF A PLOT TO KILL CASTRO OR ANY KNOWLEDGE OF AN ORGANIZED ANTI-CASTRO DEMONSTRATION. [REDACTED] STATED THAT THE ABOVE SIX INDIVIDUALS WERE SPONSORED IN THIS COUNTRY BY [REDACTED]

b6
b7c

[REDACTED] WHO WAS INTERVIEWED AT THREE THIRTY AM BY BSS, WHO STATED HE HAD NO INFORMATION REGARDING PICKETS GOING TO WASHINGTON, D.C. VIA BUS.

b6
b7c

[REDACTED] ADVISED AT FOUR THIRTY AM [REDACTED]

[REDACTED] PRO-TRUJILLO PICKET LINES, WAS INTERVIEWED AND STATED HE HAD NO KNOWLEDGE OF A BUS MOTORCADE LEAVING NYC THIS DATE, BUT THAT THREE OR FOUR BUS LOADS OF DOMINICAN SYMPATHIZERS OPPOSED TO CASTRO, WILL LEAVE

END PAGE FOUR

b6
b7c

PAGE FIVE

NYC FROM [REDACTED] FRIDAY, FOUR SEVENTEEN FIFTYNINE, AT SEVEN AM FOR WASHINGTON, D.C., WHERE THEY WILL PICKET CASTRO. LOCATED AT [REDACTED] IS THE MORE CAMPOS SOCIAL CLUB, WHICH IS A PRO-TRUJILLO ORGANIZATION.

4/16/68

[REDACTED] ALSO STATED THAT [REDACTED] WHO IS ACTIVE IN PRO-TRUJILLO PICKET LINES, WILL ACCOMPANY THIS BUS MOTORCADE TO WASHINGTON, D.C. ON FOUR SEVENTEEN FIVE NINE.

[REDACTED] ALSO ADVISED THAT [REDACTED] WAS INTERVIEWED AT SIX THIRTY AM, FOUR SEVENTEEN FIFTYNINE, AND HE ADVISED HE HAD NO ADDITIONAL INFORMATION CONCERNING PLOT TO ASSASSINATE CASTRO, BUT IF HE RECIEVED ANY ADDITIONAL INFORMATION HE WOULD NOTIFY THE NYCPD. [REDACTED]

b6
b7c

STATED THAT AT TWO THIRTY, FOUR FOURTEEN FIFTYNINE, OFFICIALS FROM THE POLO GROUNDS WILL MEET WITH REPRESENTATIVES OF CASTRO TO DISCUSS RENTAL OF THE POLO GROUNDS FOR THE CUBAN COLONIES CELEBRATION IN HONOR OF CASTRO TO BE HELD ON FOUR TWENTYFOUR FIFTYNINE.

[REDACTED] STATED THAT IF THEY COULD GET THE POLO GROUNDS FOR
END PAGE FIVE

b6
b7c

PAGE SIX

LESS THAN SEVENTY FIVE HUNDRED DOLLARS, WHICH IS NOW THE RENTAL, THEY WILL TAKE THE POLO GROUNDS FOR CASTRO-S PUBLIC APPEARANCE IN NY.

[REDACTED] ON FOUR THIRTEEN FIFTYNINE, STATED THAT AFTER LEAVING NY, CASTRO-S GROUP WILL TRAVEL TO CAMBRIDGE, MASSACHUSETTS, AND FROM THERE WILL GO THE MONTREAL, TORONTO, AND OTTOWA, AFTER WHICH THEY WILL TAKE A DIRECT FLIGHT TO HAVANA. [REDACTED] INDICATED THAT THIS TRIP IS SUBJECT TO CHANGES ANY MOMENT, BUT WILL KEEP THE NYCPD ADVISED OF ANY CHANGES. MAIL COPY SENT BOSTON, MIAMI, NEW ORLEANS, NEWARK AND SAN JUAN.

b6
b7c

CORR SHLD BE SIX PAGES

END AND ACK PLS

NY R 5 WA ELR

FEDERAL BUREAU OF INVESTIGATION
U. S. DEPARTMENT OF JUSTICE
COMMUNICATIONS SECTION

APR 15 1959

TELETYPE

Handwritten: P...
[Handwritten mark]

b6
b7C

URGENT 4-15-59 2-35 PM ETO

TO DIRECTOR, FBI 2 AND SAC, WASHINGTON FIELD
FROM SAC, NEW YORK 2 P

FIDEL CASTRO SEMI COLON [REDACTED] RE NEW YORK

b3
b6
b7C
b7E

TELETYPE APRIL FOURTEEN LAST. DETECTIVE [REDACTED] BSS,
NYCPD, ADVISED APRIL FIFTEEN THAT BUS LOAD OF PRO DASH CASTRO
SYMPATHIZERS WILL LEAVE FROM CASA CUBA, [REDACTED]

[REDACTED] A . M. OF APRIL FIFTEEN INSTANT. [REDACTED]

b6
b7C

FURTHER STATED THAT BUS LOAD OF DOMINICANS WHO ARE PRO DASH
CASTRO WILL LEAVE FROM HOTEL LUZERNE, SEVENTY NINTH STREET AND
AMSTERDAM AVENUE, NYC, FOR WASHINGTON D. C., TO WELCOME CASTRO
ON HIS ARRIVAL IN WASHINGTON THIS P. M. [REDACTED] STATED THAT THEY
SPOKE TO [REDACTED], A DOMINICAN EXILE, [REDACTED]
ANTI DASH TRUJILLO GROUP KNOWN AS THE FRENTE UNITO DEMOCRATICO
DOMINICANO. [REDACTED] ANTI DASH TRUJILLO LEADER, STATED

END PAGE ONE

BUREAU ADVISED

[REDACTED]

SEARCHED INDEXED
SERIALIZED FILED
APR 15 4 06 PM '59

b3
b6
b7C
b7E

PAGE TWO

THAT AT PUBLIC MEETING OF ALL DOMINICAN EXILE GROUPS HELD AT
WHITEHALL HOTEL, NYC, ON FEBRUARY EIGHT LAST, [REDACTED] PUBLICALLY
ADMITTED THAT HE WAS COMMUNIST. DETECTIVE [REDACTED] BSS,
NYCPD, ADVISED APRIL FIFTEEN INSTANT THAT PLANS TO RENT POLO GROUNDS
FOR CUBAN COLONY CELEBRATION FOR CASTRO HAVE BEEN CANCELLED BY
CAPTAIN [REDACTED]
TOLD [REDACTED] LATE ON APRIL FOURTEEN LAST THAT THEY INTEND TO HOLD
CUBAN COLONY CELEBRATION AT CENTRAL PARK MALL ON NIGHT OF APRIL
TWENTY FOUR NEXT, WEATHER PERMITTING. BUREAU AND WFO WILL BE
KEPT ADVISED OF FURTHER DEVELOPMENTS. MAIL COPIES SENT BOSTON,
MIAMI, NEW ORLEANS, NEWARK AND SAN JUAN.

END AND ACK PLS

NY R 2 WA WS

b6
b7c

b6
b7c

PAGE TWO

THAT ADVERTISEMENT OF THE BOOK WHICH HAD BEEN TORN FROM ONE OF THESE PAPERS WAS ENCLOSED WITH THE LETTER AND IT APPEARS TO BE THE ADVERTISEMENT OF THE BOOK TO WHICH [REDACTED] IS OBJECTING. NYCPD ADVISED OF DETAILS OF LETTER. CLEVELAND REQUESTED TO INTERVIEW [REDACTED] FOR ANY INFORMATION CONCERNING ANTI-FIDEL CASTRO REVOLUTIONARY ACTIVITIES. PERTINENT DETAILS SHOULD BE FURNISHED BUREAU, WFO, NY, BOSTON, IN ORDER TO ADVISE STATE DEPARTMENT AND LOCAL PDS CONCERNED WITH SECURITY DURING VISIT OF CASTRO TO US. END AND ACK PLS
NY R 4 WA WS

b6
b7c

FEDERAL BUREAU OF INVESTIGATION
FOI/PA
DELETED PAGE INFORMATION SHEET
FOI/PA# 1362425-000

Total Deleted Page(s) = 63

- Page 7 ~ Duplicate;
- Page 8 ~ Duplicate;
- Page 9 ~ Duplicate;
- Page 10 ~ Duplicate;
- Page 15 ~ Duplicate;
- Page 16 ~ Duplicate;
- Page 21 ~ Duplicate;
- Page 23 ~ Duplicate;
- Page 31 ~ b3; b6; b7C; b7D; b7E;
- Page 33 ~ Duplicate;
- Page 51 ~ Duplicate;
- Page 56 ~ Duplicate;
- Page 57 ~ Duplicate;
- Page 58 ~ Duplicate;
- Page 59 ~ Duplicate;
- Page 79 ~ Duplicate;
- Page 80 ~ Duplicate;
- Page 99 ~ b3; b6; b7C; b7D; b7E;
- Page 100 ~ b3; b6; b7C; b7D; b7E;
- Page 115 ~ Duplicate;
- Page 130 ~ b3; b7E;
- Page 144 ~ Duplicate;
- Page 149 ~ b3; b6; b7C; b7E;
- Page 156 ~ b3; b6; b7C; b7E;
- Page 157 ~ b3; b6; b7C; b7E;
- Page 160 ~ b3; b6; b7C; b7D; b7E;
- Page 161 ~ b3; b6; b7C; b7D; b7E;
- Page 167 ~ Duplicate;
- Page 175 ~ b3; b6; b7C; b7E;
- Page 177 ~ b3; b6; b7C; b7E;
- Page 179 ~ b3; b6; b7C; b7E;
- Page 180 ~ b3; b7E;
- Page 182 ~ b3; b6; b7C; b7E;
- Page 183 ~ b3; b7E;
- Page 185 ~ b3; b6; b7C; b7E;
- Page 186 ~ b3; b7E;
- Page 187 ~ b3; b7E;
- Page 188 ~ b3; b7E;
- Page 189 ~ b3; b6; b7C; b7E;
- Page 190 ~ b3; b7E;
- Page 191 ~ b3; b7E;
- Page 192 ~ b3; b7E;
- Page 193 ~ b3; b6; b7C; b7E;
- Page 194 ~ b3; b7E;
- Page 195 ~ b3; b7E;
- Page 196 ~ b3; b7E;
- Page 197 ~ b3; b6; b7C; b7E;
- Page 198 ~ b3; b7E;
- Page 199 ~ b3; b7E;
- Page 200 ~ b3; b7E;
- Page 202 ~ b3; b6; b7C; b7E;
- Page 203 ~ b3; b7E;
- Page 205 ~ b3; b6; b7C; b7E;
- Page 206 ~ b3; b7E;
- Page 209 ~ b3; b6; b7C; b7E;
- Page 210 ~ b3; b6; b7C; b7E;
- Page 211 ~ b3; b7E;
- Page 212 ~ b6; b7C;
- Page 213 ~ b6; b7C;
- Page 214 ~ b6; b7C;
- Page 215 ~ b6; b7C;
- Page 216 ~ b3; b6; b7C; b7E;
- Page 217 ~ b6; b7C;

XXXXXXXXXXXXXXXXXXXXXXXXXXXX
X Deleted Page(s) X
X No Duplication Fee X

X For this Page X
XXXXXXXXXXXXXXXXXXXX

~~CONFIDENTIAL~~

b6
b7C

[redacted]

b3
b7E

Date: April 14, 1959

To: Mr. L. Dennis Bailey
Director
Office of Security
Department of State
515 22nd Street, N.W.
Washington 25, D.C.

Push
[redacted]

b3
b6
b7C
b7E

From: John Edgar Hoover, Director
Federal Bureau of Investigation

Subject: FIDEL CASTRO
[redacted]

b3
b6
b7C
b7E

This will convey information orally furnished to [redacted] of the Department of State by [redacted] of this Bureau on April 13, 1959.

Detective [redacted] of the New York City Police Department on April 13, 1959, advised that he and Lieutenant [redacted] also of the New York City Police Department, met with [redacted]

[redacted] New York City, on April 13, 1959. [redacted] advised that the meeting had to do with Fidel Castro's visit to the United States and that the following individuals were present: [redacted] the palace guard, Havana, Cuba; [redacted] one of Castro's secretaries; [redacted] Cuban Tourist Bureau, New York City; and one [redacted] not further described. [redacted] advised that [redacted] a captain in the rebel forces and the person in charge of security for Castro's visit to the United States, was also in New York City. [redacted]

b6
b7C

- 1 - Havana
- 1 - Houston
- ② - WFO - SEE NOTE FOR WFO, PAGE 4

[redacted]

b3
b6
b7C
b7E

SEARCHED [redacted] INDEXED [redacted]
SERIALIZED [redacted] FILED [redacted]

APR 15 1959 1/4

[redacted]

~~CONFIDENTIAL~~

~~CONFIDENTIAL~~

Mr. W. Douglas Bailey

advised that they were much concerned over Castro's trip to the United States as they have information that there is a plot to assassinate Castro while he is in New York City.

[redacted] advised the New York City Police Department representatives that [redacted]

[redacted]

b6
b7C
b7D

[redacted]

b6
b7C
b7E

An informant, who has furnished reliable information in the past, advised that [redacted]

[redacted]

b6
b7C
b7D

~~CONFIDENTIAL~~

Mr. A. Paulin Kelley

[Redacted]

b7D

The above mentioned informant further advised that [Redacted]

b6
b7C
b7D

[Redacted]

[Redacted] advised that a place for the celebration planned by the Cuban colony for Castro on April 24, 1962, in New York City had not yet been decided upon. [Redacted] advised the New York City Police Department representatives that they canceled a reservation at the 30th Street Army because it only had a capacity for 10,000. [Redacted] stated that efforts were being made to get Madison Square Garden, but if this could not be obtained because of the crowd, the celebration would then have to be held in Central Park Mall. [Redacted] stated that Castro is prepared to speak for six or seven hours on the Cuban colony at this celebration.

b6
b7C

The above is for your information. We are endeavoring to obtain additional information and, if received, will be made available to you.

[Redacted]

b3
b7E

Mr. A. Tamm's Reply

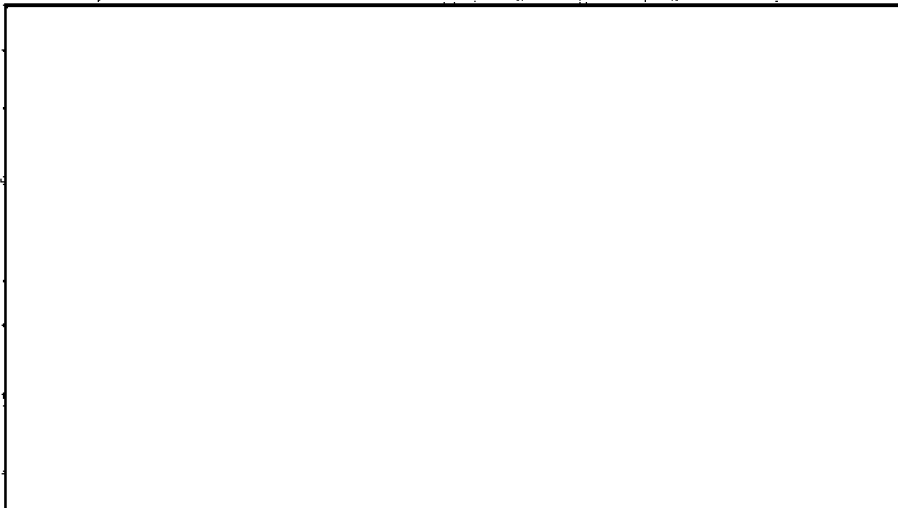

b3
b7E

NOTE FOR WFO:

Re New York tel dated 4-13-59, which reflects that the Hungarian Freedom Fighters were preparing to picket in Washington, D. C., upon Fidel Castro's arrival at the Washington airport. You should promptly furnish this information to local police authorities. The source, of course, should not be disclosed and the information should be paraphrased.

*advised
press*

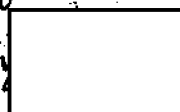

b6
b7C

4/15/59

AIRTEL

TO: DIRECTOR, FBI [redacted]

b3
b7E

FROM: SAC, WFO [redacted]

ANTI-PIDEL CASTRO ACTIVITIES

[redacted]

On 4/14/59 [redacted]

b3
b6
b7C
b7D
b7E

[redacted] furnished the following information:
[redacted] has been interviewed recently re case entitled:
[redacted]

[redacted] has recently [redacted]

[Large redacted block]

b6
b7C
b7D

On Sunday, April 11, last, [redacted]

[redacted]

b6
b7C
b7D

- 3-Bureau
- 1-Miami (Info) (RM)
- 2-New York (Info) (RM)
- 1-San Antonio (Info) (RM)
- 2-WFO

[redacted]

[redacted] (CASTRO)

AIRTEL

[Large irregular redacted block]

b3
b6
b7C
b7E

Searched [redacted]
Serialized [redacted]
Indexed [redacted]
Filed [redacted]

[redacted]

[Redacted]

b3
b6
b7C
b7D
b7E

[Redacted]

On Sunday, 4/19/59,

[Redacted]

b6
b7C
b7D

[Redacted]

[Redacted]

b6
b7C
b7D

[Redacted]

b3
b6
b7C
b7E

Date: April 15, 1959

To: Mr. S. Tullin Galtley
Director
Office of Security
Department of State
515 2nd Street, N. E.
Washington, D. C.

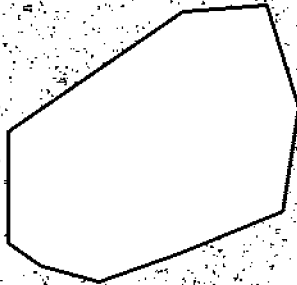

From: John Edgar Hoover, Director
Federal Bureau of Investigation

Subject: FIDEL CASTRO

[Redacted]

b3
b6
b7C
b7E

This will confirm information telephonically furnished to [Redacted] of the Department of State on April 14, 1959, by Special Agent [Redacted] of this Bureau.

On April 14, 1959, Detective [Redacted] of the New York City Police Department (NYPD) advised our New York City Office that representatives of the FICU have been advised by [Redacted] of New York City that more than 250 Dominicans assigned to Castro will leave New York City from [Redacted]

b6
b7C

[Redacted] via Greyhound bus on April 17, 1959, in order to pick up Castro in Washington, D. C. Reportedly, [Redacted] further advised that this group has contracted for six Greyhound buses at a cost of \$37.20 each and may require additional buses. [Redacted] advised FICU representatives that the group would pick up outside of the hotel in Washington, D. C., where Castro is scheduled to address a meeting of the American Society of Newspaper Editors.

According to Detective [Redacted] [Redacted] the New American Anti-Communist Association at New York City, has advised NYPD representatives that

b3
b6
b7C
b7E

- 1 - Havana
- ② - WFO - See note page 2

SEARCHED	INDEXED
SERIALIZED	FILED
APR 16 1959	
F. B. I.	

[Redacted]

Mr. E. Tomlin Bailey

he was taking approximately 100 persons to Washington, D. C., on April 17, 1959, in order to picket Castro. Reportedly, [redacted] said that during Castro's visit to New York City his group plans to picket the subject on a daily basis and as much as possible. [redacted] reportedly further indicated that Castro sympathizers may provoke a "bad incident" during the subject's visit to this country, most probably during Castro's stay in New York City.

b6
b7C

Concerning [redacted] the attention of the Department of State [redacted] is directed to FBI reports previously furnished these agencies under the caption [redacted] Registration Act, [redacted]. It is noted that on May 3, 1957, [redacted] registered [redacted]

b3
b6
b7C
b7E

Regarding [redacted] the attention of the Department of State [redacted] is directed to FBI reports previously furnished these agencies entitled "Pan American Anti-Communist Association" [redacted]

b3
b6
b7C
b7E

Note for SAC, WFO: WFO should immediately furnish a summary of the pertinent information contained herein to local police authorities.

b6
b7C

UNITED STATES DEPARTMENT OF JUSTICE

FEDERAL BUREAU OF INVESTIGATION

New York, New York

April 15, 1959

In Reply, Please Refer to
File No.

Re: Fidel Castro

[redacted]

b3
b7E

[redacted] who presently resides at [redacted] was interviewed on April 15, 1959, at which time he furnished the following information:

b6
b7C

[redacted] stated he now resides at the aforementioned address with [redacted]

[redacted] all described as Cuban political exiles who are opposed to Fidel Castro. He said the apartment is rented in the name of [redacted]

b6
b7C

[redacted] claimed that his own job in Cuba was that of [redacted]

[redacted] He informed that about 2:00 a.m. on the morning of January 1, 1959, he was personally notified that Batista was fleeing Cuba and that he should make his own departure hastily. He acknowledged that he must have been regarded as unquestionably loyal to Batista in order to receive such notification. However, he spoke lightly of his value to Batista and pointed out that if he had been regarded as highly valuable, he would not now be living in an inexpensive apartment with four other exiles and forced to make a living as a menial factory worker.

b6
b7C

[redacted] asserted he has had no contact whatsoever by any means with Batista since he left Cuba. He insisted he knew of no plot to assassinate Fidel Castro in the United States or elsewhere. Nevertheless, it was his opinion that Castro now has the support of only 45 per cent of the Cuban population and is constantly losing support. He believes that Fidel Castro will eventually be assassinated, but that the time would not be ripe before December, 1959. With regard to Castro's current visit to the United States, however, he asserted he knew of no plans to interfere in any way with the published itinerary.

b3
b6
b7C
b7E

[redacted]

SEARCHED.....INDEXED.....
SERIALIZED.....FILED.....

APR 16 1959

FBI - WASH. F. O.

b6
b7C

[redacted] stated that he was also of the opinion that the Cuban people are not ready for democracy. He said Cuba needs a strong man as dictator, but advised that he and many other exiles are opposed to returning Batista to power in Cuba. He informed that he and his exiled friends would support Jose Pedraza for the dictatorship. According to [redacted] Pedraza was an officer in Batista's army and is now in Santo Domingo, Dominican Republic, and he inferred that Pedraza has considerable support. [redacted] also claimed that the ultimate plan to overthrow the Castro government is to launch a coordinated attack of armed forces from Nicaragua, the Dominican Republic and islands adjacent to Cuba. [redacted] stated that these forces have not yet been formed and are not yet staged at these areas.

b6
b7C

[redacted] declared that neither he nor anyone of his associates has been in contact with any Dominican official and that he personally has no business with either the Cuban or Dominican Consulate in New York City. He further insisted that he is not a fighter, but an intellectual and would have no reason to be called upon to participate in any plot against Castro. He acknowledged that he has a family in Cuba, but stated that he has not been approached or pressured in any way by Castro's men to serve the present Cuban regime.

b6
b7C

[redacted] declared that he and his associates were not regarded as important and influential in the Batista regime. He stated that in his opinion, the most influential individual among the Cuban exiles in New York City is the former Cuban Senator Rafael Diaz Balart. He advised that he is not aware of Diaz' present address.

b6
b7C

This is loaned to you by the Federal Bureau of Investigation, and neither it nor its contents are to be distributed outside the agency to which loaned.

FBI

DATE: 4/15/59

Transmit the following in PLAIN TEXT

Via _____
(Priority or Method of Mailing)

TO : DIRECTOR, FBI

FROM : SAC, NEW YORK [redacted]

SUBJECT: FIDEL CASTRO
[redacted]

b3
b7E

ReNYteletype to Bureau and WFO 4/13/59.

Per Bureau instructions, [redacted] was interviewed on 4/15/59 by SAS [redacted] and [redacted]
[redacted]

b6
b7C

[redacted] agreed to furnish NYO any additional information that comes to his attention.

Enclosed for the Bureau are eleven copies of a letterhead memorandum setting forth results of the [redacted] interview. One copy of same is being furnished for the information of the Washington Field Office.

b6
b7C

- 3 - Bureau (Encl. 11) (RM) [redacted]
- 1 - Washington Field (INFO) (Encl. 1) (RM)

- 1 - [redacted]
- 1 - [redacted]
- 1 - [redacted]

b3
b6
b7C
b7E

[redacted]

(8)

Approved: _____
Special Agent in Charge

Sent

[redacted]

SEARCHED	INDEXED
SERIALIZED	FILED
M Per	APR 16 1959
[redacted]	[redacted]

[redacted]

FEDERAL BUREAU OF INVESTIGATION
U. S. DEPARTMENT OF JUSTICE
COMMUNICATIONS

b6
b7C

APR

TELETYPE

URGENT 4-16-59 12-28 AM RR

TO DIRECTOR, 1 AND WFO

FROM SAC, NEW YORK

FIDEL CASTRO, [REDACTED]

b3
b6
b7C
b7E

DR. RAFAEL L. DIAZ-BALART, FORMER SPEAKER OF THE HOUSE AND SENATOR-ELECT, AND FORMER BROTHER -IN - LAW OF CASTRO, ADVISED AT ELEVEN TWENTY P.M. FOUR FIFTEEN FIFTYNINE THAT HE HAD HEARD A RUMOR THAT EXTREME CARE SHOULD BE TAKEN CONCERNING WHAT CASTRO EATS AND DRINKS DURING HIS VISIT IN THE U.S. DIAZ SAID HE HAD NO FURTHER INFORMATION REGARDING THIS MATTER BUT CONSIDERED IT IMPORTANT ENOUGH TO NOTIFY THIS OFFICE. MAIL COPIES SENT TO BOSTON, MIAMI, NEWARK, NEW ORLEANS, AND SAN JUAN.

END AND ACK PLS

NY R 1 WA ELR¹₄

*COPIES
AD PD advised, 4/16/59
8:30 AM*

[REDACTED]

b3
b6
b7C
b7E

SEARCHED [] INDEXED []
SERIALIZED [] FILED []

APR 16 8 12 AM '59

[REDACTED]

[REDACTED]

BUREAU ADVISED

FEDERAL BUREAU OF INVESTIGATION
U. S. DEPARTMENT OF JUSTICE
COMMUNICATIONS SECTION

APR 16 1959

[Redacted]

b6
b7C

TELETYPE

T

URGENT 4-16-59 2-16 PM EST [Redacted]

TO DIRECTOR FBI AND SACS WASHINGTON FIELD, NEW YORK AND BOSTON
NEW YORK VIA WASHINGTON
FROM SAC CLEVELAND

FIDEL CASTRO, [Redacted] RE NEW YORK TEL
APRIL FIFTEEN LAST. [Redacted]

b3
b6
b7C
b7E

[Redacted] IN SUBURBS OF [Redacted], BUT NO SUCH ADDRESS
AS [Redacted] INQUIRIES PDS, CREDIT BUREAUS,
DIRECTORIES, CT. RECORDS, SOURCES AMONG SPANISH SPEAKING
ELEMENT [Redacted] AREA NEGATIVE IN EFFORT TO IDENTIFY
[Redacted] NO RECORD [Redacted] EMPLOYMENT OFFICES
AND UNEMPLOYMENT BUREAUS IN [Redacted] AREA. NO FURTHER EFFORT
BEING MADE TO IDENTIFY [Redacted]. UACB MATTER . RUC.

END ACK PLS

WA 2-17 PM OK FBI WA NM R RELAY

TUM UM OK FBI BS ARI

TU DISC

b3
b6
b7C
b7E

[Redacted]

SEARCHED [Redacted] INDEXED [Redacted]

SERIALIZED [Redacted] FILED [Redacted]

APR 16 3 20 PM '59

BUREAU ADVISED

RELAYED TO [Redacted]

hy

[Redacted]

[Redacted]

April 16, 1959

AIRTEL

TO: DIRECTOR, FBI [redacted]

b3
b7E

FROM: SAC, WFO [redacted]

FIDEL CASTRO RUZ
[redacted]

Re myairtel 4/15/59.

The following information concerning CASTRO's visit to Washington, D. C., set forth:

It is noted that all pertinent information pertaining to security of CASTRO, as furnished by Bureau, auxiliary offices and sources, has been furnished by WFO to Metropolitan Police Department (MPD), Park Police and Fairfax County Police Department.

The following activities regarding picketing were observed by SAs [redacted] and [redacted].

b6
b7C

From 4:45 to 5:45 P.M. 4/15/59 approximately 34 individuals carrying 21 signs were observed picketing in an orderly fashion vicinity of White House. Slogans on signs were as follows:

"CASTRO WILL RING PANAMA CANAL WITH COMMUNIST SATELLITES"
"FIDEL CASTRO -- RED PUPPET"

[redacted]

- 3 - Bureau
- 1 - Miami (Info)(RM)
- 1 - New York (Info)(RM)
- 1 - WFO

[redacted]
(6) [redacted]

[redacted]

A I R T E L

[redacted]

b3
b6
b7C
b7E

Searched _____
 Serialized _____
 Indexed _____
 Filed _____

[redacted]

[redacted]

b3
b7E

"FIDEL -- NEWEST DICTATOR IN WESTERN HEMISPHERE"
"GRACIAS FIDEL -- KRUSHCHEV"
"MARXISM NOW TAUGHT IN CUBA WITH CONSENT OF CASTRO"

It was observed following individuals also present at above picket:

[redacted]

b6
b7C
b7D

At 6:30 P.M., approximately 500 pro-CASTRO followers observed at Washington National Airport, Military Air Transport Service. Very few were carrying pro-CASTRO placards. Approximately four of above anti-CASTRO pickets present carrying placards. CASTRO airplane arrived approximately 9:30 P.M. He was convoyed to Cuban Embassy, Washington, D. C., and after conversing on sidewalk with followers, entered Embassy. Captain [redacted] MPD, telephonically advised WFO 10:05 P.M. no incidents had occurred and CASTRO indicated desire to go to bed.

b6
b7C

On 4/16/59 approximately 25 anti-CASTRO people commenced picketing vicinity of Statler Hotel, Washington, D. C., at 12:15 P.M. under leadership of [redacted] [redacted] observed in vicinity of picketing.

CASTRO arrived Statler 12:30 P.M. for luncheon with Undersecretary of State CHRISTIAN HERTER. No incidents at that time. At approximately 1:00 P.M. [redacted] observed in heated argument in Spanish language with unidentified Latin American male. Argument culminated in exchange of blows, which was quickly broken up by Captain [redacted] MPD, and unidentified MPD lieutenant. Pickets left area 1:15 P.M. without further incident.

b6
b7C

CASTRO departed Statler Hotel approximately 2:30 P.M., arriving Cuban Embassy approximately 2:40 P.M.

PSI [redacted] telephonically advised SA [redacted] night of 4/15/59 [redacted]

b6
b7C
b7D

[redacted]

[Redacted]

[Redacted] on 4/16/59 telephonically advised SA

[Redacted]

b3
b6
b7C
b7D
b7E

on 4/16/59 [Redacted] advised SA [Redacted]

[Redacted]

b6
b7C
b7D

Informant stated [Redacted]

[Redacted]

b6
b7C
b7D

[Redacted]

b6
b7C
b7D

[redacted]

Informant stated [redacted]

[redacted]

b3
b6
b7C
b7D
b7E

[redacted] further told [redacted] that [redacted] could

[redacted]

Informant stated [redacted]

[redacted]

b6
b7C
b7D

[redacted] was questioned

re possibility this person [redacted]

[redacted] but informant did not know of any connection between
[redacted] and this person.

b6
b7C
b7D

Informant stated [redacted]

[redacted]

Informant could furnish no information re [redacted]

[redacted]

b6
b7C
b7D

knew nothing re [redacted] and group mentioned in New York
City teletype 4/14/59.

Photographs of [redacted] and [redacted] which
have been furnished to MPD will be exhibited to informant.

b6
b7C

[redacted]
[redacted] has furnished information set forth below and in
airtel 4/15/59 indicating he will be of value in coverage
of anti-CASTRO activities. On 4/16/59 [redacted] contacted
SA [redacted]

[redacted]

b6
b7C
b7D

[redacted]

[redacted]

b3
b6
b7C
b7D
b7E

PSI stated that [redacted]

[redacted]

[redacted]

[redacted] He will advise WFO immediately of plans formulated. If information developed re security of CASTRO, this will be immediately furnished appropriate local authorities and the Bureau and auxiliary offices will be advised.

On 4/15/59 [redacted] American-Hungarian Federation, 1761 R Street, N. W., advised SA [redacted] [redacted] had contacted [redacted] for assistance in demonstrations against CASTRO. [redacted] said his organization does not intend to participate.

b6
b7C

Information of pertinence to other agencies will be submitted in a form suitable for dissemination and the Bureau will be kept advised of happenings on a current basis.

4/16/59

AIRTEL

TO: DIRECTOR, FBI

FROM: SAC, NEW YORK [redacted]

FIDEL CASTRO
[redacted]

ReNYtel, 4/16/59.

Attached are Photostats of the letter described in the referenced teletype which are being furnished for the investigative assistance of the interested Offices. The original letter is being maintained by NYO.

- 3 - Bureau (Enc. 1) (RM) [redacted]
- 1 - Cleveland (Enc. 1) (RM) [redacted]
- ① - Washington Field (Enc. 1) (RM)
- 1 - New York [redacted]

[redacted] (#31)
(7)

b3
b7E

b3
b6
b7C
b7E

b3
b6
b7C
b7E

[redacted]

SEARCHED	INDEXED
SERIALIZED	FILED
APR 17 1959	
[redacted]	[redacted]
[redacted]	[redacted]

AIR TEL - AIR MAIL - REGISTERED

To: Director, FBI
From: SAC, New Orleans [redacted]
Re: FIDEL CASTRO
[redacted]

b3
b7E

Reairtel to New York 4/13/59, and airtel to Washington Field Office 4/13/59.

[redacted] (Protect Identity), [redacted]

b6
b7C
b7D

[Large redacted block]

On April 14, 1959, [redacted] Special Agent, Office of Security, U. S. Department of State, New Orleans, advised that he has received no word from his Washington office indicating that CASTRO would visit New Orleans. In the event [redacted] did receive such information, he stated he would make same available to the New Orleans Division for informational purposes. He also related that in the event CASTRO's visit to New Orleans did materialize, his office would have to provide some type of protection for CASTRO although it was not an official visit to the U. S. In such an instance, he stated he would request assistance from the local police authorities in New Orleans.

b6
b7C

On April 14, 1959, [redacted] contacted

- 3 - Bureau [redacted]
- 1 - Boston (Info) (AM - Registered)
- 1 - Miami (Info) (AM - Registered)
- 1 - New York (Info) [redacted]
- 1 - Newark (Info) (AM - Registered)
- 1 - Washington Field Office (Info) (AM - Registered)
- 2 - New Orleans (1 - [redacted])

b3
b6
b7C
b7E

[redacted]
(10)

SEARCHED [] INDEXED []
SERIALIZED [] FILED []

APR 17 1959

[redacted] [redacted] [redacted]

FEDERAL BUREAU OF INVESTIGATION
U. S. DEPARTMENT OF JUSTICE
COMMUNICATIONS SECTION

APR 17 1959

[Redacted]

b6
b7C

TELETYPE

URGENT 4-17-59 12-34 PM [Redacted]

TO DIRECTOR 2 AND SAC WASHINGTON FIELD

FROM SAC NEW YORK 1P

b3
b6
b7C
b7E

FIDEL CASTRO, [Redacted] DETECTIVE [Redacted] BSS, NYCPD, ADVISED

FIVE GREYHOUND BUSES LEFT NYC SEVEN FORTY FIVE AM THIS DATE TO PICKET

FIDEL CASTRO. GROUP COMPOSED MAINLY OF DOMINICANS. [Redacted] STATED

THAT MORE THAN ONE HUNDRED WERE LEFT HERE IN NY AS THEY DID NOT HAVE

SUFFICIENT BUSES. [Redacted] SPOKE TO [Redacted] A DOMINICAN WHO

b3
b6
b7C
b7E

IS HANDLING THE PICKETING, WHO TOLD HIM THAT THESE PICKETS WERE BEING

HIRED THROUGH THE DOMINICAN CONSULATE IN NYC. PICKETS INTEND TO RETURN

TO NY FROM WASHINGTON LATE THIS EVENING ARRIVING NY [Redacted] AM, APRIL

EIGHTEEN, NEXT.

ND

NY R 2 WA AR

SEARCHED [Redacted] FILED [Redacted]
SERIALIZED [Redacted] APR 17 2 10 PM '59
BY [Redacted]
U ADVISED
[Redacted]

12 48 P, [Redacted]

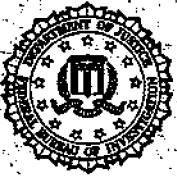

UNITED STATES DEPARTMENT OF JUSTICE
FEDERAL BUREAU OF INVESTIGATION

In Reply, Please Refer to
File No.

Houston, Texas
April 15, 1939

Mr. WILK (CASTRO)

[Redacted]

On April 10, 1939, [Redacted]

[Redacted] Houston oil man [Redacted]
Frank I. Peters Oil Company, Houston, Texas, advised
that on April 11, 1939, several businessmen from Houston
were flying to Havana, Cuba, in the private plane of
[Redacted] to invite WILK (CASTRO) to visit Houston,
Texas.

[Redacted] identified these men as [Redacted]

[Redacted]

[Redacted] related that information in his possession
was to the effect that [Redacted] was going to invite
CASTRO to spend two days in Houston, Texas, on or about
April 30, 1939, in connection with a proposed tour by
CASTRO of the United States and Canada.

[Redacted]

[Redacted]
SEARCHED INDEXED
SERIALIZED FILE
APR 17 1939

Property of FBI - This memorandum is loaned to you
and neither it nor its contents are to be distributed
outside the agency to which loaned.

b3
b6
b7C
b7E

b6
b7C

b6
b7C

b3
b6
b7C
b7E

4/13/59

AIRTEL

AIRMAIL

TO: DIRECTOR, FBI [redacted]
 FROM: SAC, HOUSTON [redacted]
 RE: FIDEL CASTRO
 [redacted]

b3
b7E

Rebuairtel to Houston, 4/16/59.

The Bureau's attention is respectfully directed to Houston airtel to Bureau dated 4/13/59, captioned "Top Hoodlum Progress, Weekly Summary."

For the benefit of offices not receiving copies of referenced Houston airtel to Bureau 4/13/59, [redacted] is

b6
b7C

Information has been obtained that [redacted] a New Orleans hoodlum, has been in contact with [redacted] in fact, during the past week was in the Houston office of [redacted] at which time a \$10,000 check was cashed and it is believed the proceeds of this check were possibly given to [redacted].

Enclosed herewith for the Bureau is an original and four copies of a letterhead memorandum relative to information made available to the Houston Division by [redacted]

b6
b7C

- 3 - Bureau (Encl. 5) (AM-EM)
- 1 - Boston (Encl. 1) (AM) RM
- 1 - Miami (Encl. 1) (AM) RM
- 1 - Newark (Encl. 1) (AM) RM
- 1 - New Orleans (Encl. 1) (AM) RM
- 1 - New York (Encl. 1) (AM) RM
- 1 - WFO (Encl. 1) (AM) RM
- 3 - Houston (1 - 92-34)

b3
b6
b7C
b7E

[redacted]
(12)

[redacted]

SEARCHED INDEXED
 SERIALIZED FILED
 APR 17 1959



b3
b7E

Copies of this letterhead memorandum are also enclosed for each division receiving copies of this communication.

The data made available to the Houston Division in referenced Bureau airtel to Houston 4/10/59, was disseminated to local authorities at Houston on 4/15/59.

The source of this information, of course, was not disclosed and the information was appropriately paraphrased.

This matter will be followed very closely by the Houston Division and the Bureau will be kept fully advised of any and all pertinent developments in this matter.

b6
b7C

~~CONFIDENTIAL~~

April 17, 1959

[redacted]

b3
b7E

A confidential informant, who has furnished reliable information in the past, advised on April 15, 1959, that [redacted]

[redacted]

b3
b7E

A second confidential informant, who has furnished reliable information in the past, advised on April 16, 1959, that [redacted]

[redacted]

b3
b7E

On April 16, 1959, Lieutenant [redacted] Special Investigations Squad, Metropolitan Police Department, Washington, D. C., advised a Special Agent of the Federal Bureau of Investigation, Washington, D. C., that [redacted]

b6
b7C

[redacted] purchased from Whelan Drug Company, 1401 H Street, N. W., seven Colt thirty-eight caliber pistols with two-inch barrels and three boxes of thirty-eight caliber ammunition.

Lieutenant [redacted] also advised that [redacted] was also in possession of twelve additional thirty-eight caliber pistols, two-inch barrels, and three more boxes of thirty-eight caliber ammunition.

b6
b7C

- 5 Bureau [redacted]
- 2 Miami (RM) (1-FIDEL CASTRO)
- 2 New York (RM) (1-FIDEL CASTRO)
- 2 WFO [redacted]

[redacted]

b3
b6
b7C
b7E

(11)

Searched _____
Serialized _____
Indexed _____
Filed _____

~~CONFIDENTIAL~~

[redacted]

~~CONFIDENTIAL~~



b3
b7E

This memorandum is loaned to you by the Federal Bureau of Investigation and neither it nor its contents are to be distributed outside the agency to which loaned.

- 2 -

~~CONFIDENTIAL~~

4/17/59

AIRTEL

TO: DIRECTOR, FBI [redacted]

FROM: SAC, WFO [redacted]

b3
b7E

[redacted]

Enclosed are 5 copies to the Bureau and 2 copies to NY and Miami for info of a letterhead memo dated 4/17/59.

The informant mentioned as having furnished the information in enclosed memo on 4/15/59, is [redacted] and the second informant, who furnished information on 4/16/59, is [redacted]

b3
b7E

The information contained in enclosed letterhead memo was furnished to SA [redacted] by Lieut. [redacted] Special Investigations Squad, MPD, WDC.

b6
b7C

The information in enclosed letterhead memo furnished by Lieut. [redacted] was in turn furnished to Lieut. [redacted] of the Bureau of Special Services, NY PD, on 4/16/59, by Captain [redacted] Special Investigations Squad, MPD, WDC.

b6
b7C

The enclosed memo is classified "~~Confidential~~"

[redacted] and since the data reported could reasonably result in the identification of the confidential informants of continuing value and compromise the future effectiveness thereof.

b3
b7E

- 3 Bureau (Encls. 5)
- 2 Miami (Encls. 2) (RM)
- (1-FIDEL CASTRO)
- 2 New York (Encls. 2) (RM)
- 2 WFO [redacted]

[redacted]

AIRTEL

63

Searched _____

Serialized _____

Indexed _____

Filed _____

b3
b6
b7C
b7E

(9)

~~CONFIDENTIAL~~

April 17, 1959

[Redacted]

b3
b7E

A confidential informant, who has furnished reliable information in the past, advised on April 16, 1959, [Redacted]

[Redacted]

b3
b6
b7C
b7E

[Redacted]

This memorandum is loaned to you by the Federal Bureau of Investigation and neither it nor its contents are to be distributed outside the agency to which loaned.

- 5-Bureau [Redacted]
- 2-Miami (RM)
 - (1-FIDEL CASTRO)
- 2-Newark (RM)
 - (1-FIDEL CASTRO)
- 2-New York (RM)
 - (1-FIDEL CASTRO)
- 2-WFO [Redacted]

[Redacted]

b3
b6
b7C
b7E

[Redacted]

(13)

Searched _____
 Serialized _____
 Indexed _____
 Filed _____

[Redacted]

b3
b6
b7C
b7E

4/17/59

AIRTEL

TO: DIRECTOR, FBI [redacted]

FROM: SAC, WFO [redacted]

[redacted]

b3
b7E

Enclosed are 5 to the Bureau, 2 to Miami, Newark and New York of a letterhead memo dated 4/17/59.

The information in enclosed memo was furnished by [redacted] on 4/16/59.

b3
b7E

The enclosed memorandum is classified "~~Confidential~~"

[redacted] and since the data reported could reasonably result in identification of the confidential informant of continuing value and compromise the future effectiveness thereof.

- 3-Bureau (Encls.5)
- 2-Miami (RM) (Encls.2)
(1-FIDEL CASTRO)
- 2-Newark (RM) (Encls.2)
(1-FIDEL CASTRO)
- 2-New York (RM) (Encls.2)
(1-FIDEL CASTRO)

② WFO [redacted]

[redacted]

[redacted]

(11)

b3
b6
b7C
b7E

Searched _____
Serialized _____
Indexed _____
Filed _____

AIRTEL

[redacted]

b3
b7E

~~CONFIDENTIAL~~

April 17, 1959

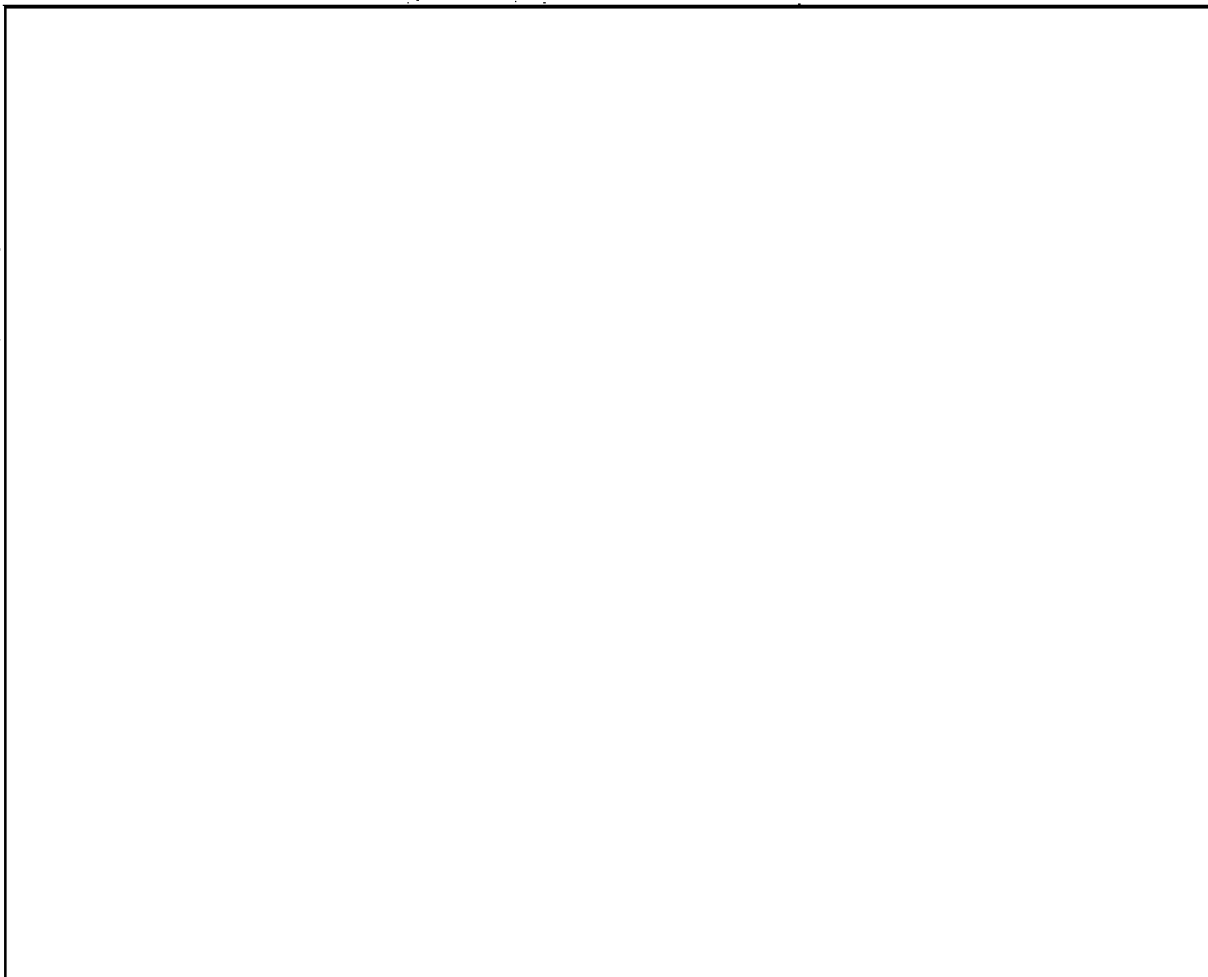

b3
b7E

This memorandum is loaned to you by the Federal Bureau of Investigation and neither it nor its contents are to be distributed outside the agency to which loaned.

5 Bureau [redacted]
2 WFO [redacted]
[redacted]
[redacted]
(7)



b3
b6
b7C
b7E

Searched [redacted]
Serialized [redacted]
Indexed [redacted]
Filed [redacted]

~~CONFIDENTIAL~~



b3
b6
b7C
b7E

4/17/59

AIRTEL

TO: DIRECTOR, FBI [redacted]

FROM: SAC, WFO [redacted]

[redacted]

b3
b7E

Enclosed to the Bureau are 5 copies of a letter-head memo dated 4/17/59.

The information in enclosed memo was furnished by [redacted] on 4/16/59.

b3
b7E

The enclosed memo is classified "~~Confidential~~"

[redacted] and since the data reported could reasonably result in identification of the confidential informant of continuing value and compromise the future effectiveness thereof.

3-Bureau (Encls.5)

②-WFO

[redacted]

[redacted]

(5)

[redacted]

[redacted]

b3
b6
b7C
b7E

AIRTEL

Searched _____
Serialized [] _____
Indexed _____
Filed [] _____

b3
b6
b7C
b7E

~~CONFIDENTIAL~~

~~CONFIDENTIAL~~
APR 17 1959

[redacted]

b3
b7E

A confidential informant, who has furnished reliable information in the past, advised on April 16, 1959, [redacted]

[redacted]

b3
b7E

The informant then learned that [redacted]

[redacted]

This memorandum is loaned to you by the Federal Bureau of Investigation and neither it nor its contents are to be distributed outside the agency to which loaned.

5-Bureau [redacted]

2-Newark [redacted]

2-WFO [redacted]

[redacted]

[redacted]

(9)

b3
b6
b7C
b7E

~~CONFIDENTIAL~~

~~CONFIDENTIAL~~

Searched [redacted]
Serialized [redacted]
Indexed [redacted]
Filed [redacted]

[redacted]

b3
b6
b7C
b7E

4/17/59

AIRTEL

TO: DIRECTOR, FBI [redacted]

FROM: SAC, WFO [redacted]

[redacted]

b3
b7E

Enclosed for the Bureau are 5 copies of a letterhead memo and 2 to Newark for information, dated 4/17/59.

The information in enclosed memo was furnished by [redacted] on 4/16/59.

b3
b7E

It should be noted by the Newark Office that the Prime Minister, FIDEL CASTRO, will be departing WDC, via Pa. R.R., 4/20/59, at 4 p.m. to arrive in New Jersey to attend Princeton University that evening. No additional information concerning his visit to Princeton is known by the informant.

Newark Office should furnish local authorities information of alleged plots to assassinate CASTRO.

The Bureau is not engaged in any security measures, but Newark should effect liaison with local authorities to be apprised of any pro or anti CASTRO activities and keep the Bureau and interested offices advised.

The enclosed memo is classified "~~Confidential~~"

[redacted]

and since the data reported could reasonably result in identification of the confidential

b3
b7E

- 3-Bureau (Encls 5)
- 2-Newark (Encls 2) (RM) (Info)
- (1-FIDEL CASTRO)
- 2-WFO

[redacted]

[redacted]

[redacted]

AIRTEL

b3
b6
b7C
b7E

Searched _____
Serialized _____
Indexed _____
Filed _____

[redacted]



b3
b7E

informant of continuing value and compromise the future effectiveness thereof.

~~Searched _____
Serialized _____
Indexed _____
Filed _____~~

April 17, 1959

AIRTEL

TO: DIRECTOR, FBI [redacted]

FROM: SAC, WFO [redacted]

FIDEL CASTRO RUZ
[redacted]

b3
b7E

Remyairtel 4/16/59.

The following is a summary of activities pertaining to subject since referenced airtel.

At approximately 6:00 P.M. 4/16/59 CASTRO departed Cuban Embassy, walked south 16th Street to Kalorama Road followed by approximately 100 persons. He conversed with individuals in the crowd at 16th and Kalorama for approximately fifteen minutes, crossed 16th Street, and entered Meridian Hill Park. He stayed in park for approximately one hour, entering Cuban Embassy 7:15 P.M. While in park he posed for photographs, kissed babies and engaged in conversations with followers and signed autographs.

Subject departed Cuban Embassy approximately 10:15 A.M. 4/17/59, drove to U. S. Capitol Building and entered Foreign Relations Room, where he remained until approximately 12:20 P.M. He then journeyed to Statler Hotel, arriving 12:30 P.M., for luncheon with American Society of Newspaper Editors.

b6
b7C

- 3 - Bureau
- 1 - Miami (Info)(RM)
- 1 - New York (Info)(RM)
- 1 - WFO

(6) [redacted]

A I R T E L

Searched [redacted]
 Serialized [redacted]
 Indexed [redacted]
 Filed [redacted]

b3
b6
b7C
b7E

[redacted]

[redacted]

b3
b7E

A pro-CASTRO group of approximately 45 men and women picketed south side of K Street between 15th and 16th Streets from 12:30 P.M. until approximately 3:30 P.M.

At 1:30 P.M. five busloads of anti-CASTRO persons believed to be pro-TRUJILLO persons arrived vicinity Statler Hotel. These persons numbered approximately 250 and were permitted to picket south side of K Street between 16th and 17th Streets. Numerous police officers in vicinity and picketing carried on in orderly fashion. At 4:45 P.M. the 250 pickets boarded buses and travelled to 16th and Florida Avenue, not being allowed closer to the Cuban Embassy than the junction of these streets.

CASTRO returned Cuban Embassy 4:50 P.M.

Above activities observed by SAs [redacted]

[redacted] who also observed that [redacted] was present during picketing Statler Hotel. Also present were [redacted]

b6
b7C
b7D

Captain [redacted] MPD, advised on evening 4/16/59 that because of [redacted] overbearing attitude concerning pickets he, [redacted] had very sternly made both [redacted] aware of the fact that the MPD would handle the picket lines and that if either of these persons interfered, stern action would be taken against them. On 4/17/59 [redacted] advised that CASTRO would visit Vice President NIXON 7:00 P.M. Sunday at the Capitol rather than at NIXON's home.

b6
b7C

PSI [redacted] advised SA [redacted] on 4/17/59 [redacted] and keep WFO advised.

b6
b7C
b7D

PSI [redacted] advised SA [redacted] 4/17/59 [redacted] PSI will keep WFO advised.

b6
b7C
b7D

[redacted]

[redacted] on 4/16 and 17/59 advised SA [redacted]

[redacted]

[redacted] Informant could furnish no information concerning planned incidents regarding CASTRO.

With regard to [redacted] PSI [redacted] advised that [redacted]

[redacted]

[redacted], etal.

For the information of the Bureau, all data pertaining to security of CASTRO has been furnished to the MPD, Park Police and Fairfax County Police Department immediately upon receipt. As mentioned in WFO airtel 4/15/59, two MPD detectives are riding with State Department representative and all information furnished to MPD by WFO is verbally furnished to State Department representative on street with MPD.

WFO will submit data of interest to other agencies in form suitable for dissemination and will keep Bureau advised on current basis.

at 5:00 PM, 250 pickets boarded 5 buses and left for NYC, approximately.

b3
b6
b7C
b7D
b7E

b6
b7C
b7D

FEDERAL BUREAU OF INVESTIGATION
U. S. DEPARTMENT OF JUSTICE
COMMUNICATIONS SECTION

APR 19 1959

TELETYPE

URGENT 4-19-59 1-10 PM ETO

TO DIRECTOR AND SAC, WASHINGTON FIELD

FROM SAC, NEW YORK 1 P

FIDEL CASTRO., [redacted] ONE OF LEADERS
OF JULY TWENTY SIX IN NEW YORK CITY, ADVISED THIS DATE THAT HE
RECEIVED TELEPHONE CALL FROM WASHINGTON, D. C., LATE ON NIGHT OF
FOUR EIGHTEEN LAST FROM [redacted]

b3
b6
b7C
b7E

[redacted] WHO STATED THAT HE HAD JUST RECEIVED INFORMATION THAT
THREE ARMED UNIDENTIFIED CUBANS HAD REGISTERED AT THE STATLER
HILTON HOTEL, NEW YORK CITY, TO AWAIT ARRIVAL OF FIDEL CASTRO
IN NEW YORK CITY. ABOVE INFORMATION FURNISHED THIS DATE TO STATE
DEPARTMENT, NEW YORK CITY, AND NEW YORK CITY POLICE DEPARTMENT.
BUREAU WILL BE KEPT ADVISED OF ANY FURTHER DEVELOPMENTS.

END

BUREAU ADVISED

1-12 PM OK FBI WA NM

TU

1/4

Handwritten:
Notified by phone
2 pm 4/19/59

Handwritten:
Dest [redacted]
Special Investigation
advised 4/19/59

[redacted]	
SEARCHED [redacted]	INDEXED [redacted]
SERIALIZED [redacted]	FILED [redacted]
APR 19 3 12 PM '59	
[redacted]	

b3
b6
b7C
b7E

[Redacted]

2

Date: April 15, 1959

b3
b7E

To: Mr. A. Martin Bailey
Director
Office of Security
Department of State
515 West Avenue, S. E.
Washington 25, D. C.

From: John Edgar Hoover, Director
Federal Bureau of Investigation

Subject: FINEA MEXICO

[Redacted]

b3
b6
b7C
b7E

Reference is made to our letter dated April 14, 1959, captioned as above, which contained information furnished this Bureau on April 13, 1959, by representatives of the New York City Police Department. [Redacted] was described in the referenced letter as [Redacted] for Castro's aims in the United States.

On April 13, 1959, [Redacted] was interviewed at his own request by a Special Agent of our New York Office and a representative of the New York City Police Department. Also present during the interview with [Redacted] and [Redacted] as associates of [Redacted] and two other unidentified Cuban nationals.

b6
b7C

[Redacted] advised they believe the man most capable of assassinating Castro during his visit to the United States is [Redacted]

[Redacted] A Havana, Cuba, [Redacted] said other suspects include an associate of [Redacted] named Juan, first name unknown, and [Redacted] also [Redacted] described as an individual now wanted for Captain [Redacted]

b3
b6
b7C
b7E

- 1 - Havana
- 1 - Ottawa
- ② - WFO - SEE NOTE FOR WFO, PAGE 4

SEARCHED	INDEXED
SERIALIZED	FILED
APR 20 1959	

[Redacted]

Mr. E. Tomlin Bailey

Others named by [redacted] as being opposed to Castro and who may seek to harm him were [redacted]

b6
b7C

[redacted] said he had learned Dominican and Cuban pickets were being sent in chartered busses from New York to Washington, D. C., to picket Castro. According to [redacted] this group of pickets would be paid \$50 per day and had been hired by [redacted] who is working with [redacted] New York City.

b6
b7C

[redacted] said they had been told that one Brigadier General Francisco "Cillo" Tabernilla had hired persons to go to Washington, D. C., and New York City at the cost of \$100 per day for the purpose of picketing Castro.

Detective [redacted] of the New York City Police Department advised on April 14, 1959, that representatives of his Department on that date interviewed several occupants of a small apartment located at [redacted]

b6
b7C

[redacted] He identified those interviewed as [redacted] Immigration and Naturalization Service (INS) Number [redacted] INS Number [redacted]

[redacted] a newspaper and television representative from Havana;

[redacted] INS Number [redacted]

[redacted] INS Number [redacted]

[redacted] INS number [redacted]

who had no immigration documents in his possession.

Detective [redacted] said [redacted] acted as spokesman for the group and consented to a search of the apartment, which search disclosed no firearms. [redacted] told

Detective [redacted] he had no knowledge of a plot to kill Castro or of an organized demonstration planned against Castro. Detective [redacted] also advised the New York City Police Department on April 14, 1959, interviewed [redacted]

b6
b7C

[redacted] sponsor of the above-mentioned six occupants of the apartment at [redacted]

[redacted] who denied he knew of plans for pickets to go to Washington, D. C., from New York City by bus.

Mr. E. Tomlin Bailey

[redacted]
[redacted]
[redacted] was also interviewed by the New York City Police Department on April 14, 1959, according to Detective [redacted] reportedly advised that three or four bus loads of Dominican sympathizers opposed to Castro will leave the headquarters of a pro-Trujillo organization, Morel Campos Social Club, 646 Jackson Avenue, Bronx, New York, at 7 a.m., April 17, 1959, for Washington, D. C., where they will picket Castro. [redacted] told the New York City Police Department that [redacted] a follower of Generalissimo Trujillo, will accompany the group to Washington, D. C.

b6
b7C

Detective [redacted] further advised the New York City Police Department learned from [redacted] who was identified in the referenced letter from this Bureau as [redacted] on April 14, 1959, that representatives of Castro planned to meet with officials of the Polo Grounds in New York City on that date in an effort to make arrangements for use of the Polo Grounds for a celebration in honor of Castro planned for April 24, 1959.

b6
b7C

Concerning Castro's itinerary after his visit to New York City, [redacted] advised on April 13, 1959, that the group plans to go to Cambridge, Massachusetts, from New York City and to then visit Montreal, Toronto and Ottawa, Canada, returning to Havana by direct flight from Ottawa. It was indicated that this itinerary is subject to change at any moment. Any additional pertinent information received by this Bureau will be furnished recipient agencies.

b6
b7C

[redacted]

b3
b7E

Mr. E. Tomlin Bailey

NOTE FOR SAC, WASHINGTON FIELD:

Re New York tel to Bureau and WFO, 4/14/59,
11:22 p.m. Promptly furnish information concerning plans
of pickets to come to Washington, D. C., on 4/17/59 to
local police authorities.



b6
b7c

~~CONFIDENTIAL~~

April 16, 1959

FIDEL CASTRO

On April 16, 1959, a confidential source, who has furnished reliable information in the past, advised that

b3
b7E

This memorandum is loaned to you by the Federal Bureau of Investigation and it is not to be distributed outside the agency to which loaned.

- 55- Bureau
- 1 - Houston
- 1 - New Orleans
- 1 - Miami
- ② - WFO

(10)

b3
b6
b7C
b7E

~~CONFIDENTIAL~~

Searched _____

Serialized _____

Indexed _____

Filed _____

b3
b6
b7C
b7E

4/18/59

AIRTEL

TO: DIRECTOR, FBI [redacted]

b3
b7E

FROM: SAC, WFO [redacted]

FIDEL CASTRO

[redacted]
(OO:MM)

Attached hereto are five copies for the Bureau and one copy each for Houston, New Orleans, and Miami of a letter-head memo dated and captioned as above.

The information contained therein was furnished by [redacted]

b3
b7E

Houston and New Orleans will be immediately advised of any additional info re CASTRO's visiting or not visiting these cities.

The attached memo is classified "~~Confidential~~" [redacted] and because the info contained therein might tend to identify an informant of continuing value and compromise the future effectiveness thereof.

b3
b7E

sent 4/18/59

- 3 - Bureau (Encls.5)
- 1 - Houston (Encl.1)(Info)(RM)
- 1 - New Orleans (Encl.1)(Info)(RM)
- 1 - Miami (Encl.1)(Info)(RM)
- 2 - WFO

[redacted]

[redacted]

[redacted]
(8)
[redacted]

b3
b6
b7C
b7E

AIRTEL

Searched _____
Serialized [redacted]
Indexed [redacted]
Filed [redacted]

b3
b6
b7C
b7E

[redacted]

b6
b7C

~~CONFIDENTIAL~~

April 18, 1959

FIDEL CASTRO

On April 17, 1959, a confidential source, who has furnished reliable information in the past, advised

[redacted]

b3
b7E

[redacted]

b3
b7E

On April 18, 1959, Captain [redacted] Special Services, Metropolitan Police Department, Washington, D. C., advised that [redacted]

b6
b7C

[redacted] has purchased eight more .38 caliber pistols in Washington, D. C., bringing the number of such pistols he has purchased since the arrival of Fidel Castro to 27.

This memorandum is loaned to you by the Federal Bureau of Investigation, and neither it nor its contents are to be distributed outside the agency to which loaned.

- 5 - Bureau
- 1 - Boston
- 1 - Miami
- 1 - Newark
- 1 - New York
- ② - WFO [redacted]

(11)

[redacted]

Searched [redacted]

Serialized [redacted]

Indexed [redacted]

Filed [redacted]

~~CONFIDENTIAL~~

[redacted]

~~CONFIDENTIAL~~

b3
b6
b7C
b7E

[redacted]

4/18/59

Airtel

TO: DIRECTOR, FBI [redacted]

b3
b7E

FROM: SAC, WFO [redacted]

FIDEL CASTRO
[redacted]
(OO:MM)

Attached hereto are five copies of a letterhead memo for the Bureau and one each for NY, NK, MM, and BS, for info, dated and captioned as above.

The information contained therein was furnished by [redacted]

b3
b7E

NY and NK will be immediately advised if any definite plans for CASTRO's appearance on the Barry Gray Show or his attendance at the Abyssinian Baptist Church are learned.

The information furnished by Captain [redacted] was furnished to SA [redacted]

b6
b7C

The attached letterhead memo is classified "~~Confidential~~"

[redacted]

b3
b7E

and the information contained therein might tend to identify an informant of continuing value and compromise the future effectiveness thereof.

- 3 - Bureau (Encls. 5)
- 1 - Boston (Encl. 1) (Info) (RM)
- 1 - Miami (Encl. 1) (Info) (RM)
- 1 - Newark (Encl. 1) (INFO) (RM)
- 1 - New York (Encl. 1) (Info) (RM)
- ② - WFO

Rec'd 4/18/59

[redacted]
[redacted]
(9)
[redacted]
[redacted]

[redacted]

b3
b6
b7C
b7E

AIRTEL

Searched [redacted]
Serialized [redacted]
Indexed [redacted]
Filed [redacted]

[redacted]

4/18/59

AIRTEL

TO: DIRECTOR, FBI [redacted]

FROM: SAC, WFO [redacted]

FIDEL CASTRO
[redacted]

b3
b7E

Remyairtel 4/17/59.

On the evening of 4/17/59, during reception held at Cuban Embassy. Detective [redacted] MPD, advised SA [redacted] a rumor was circulated that a hostile Dominican was in attendance at the reception. Cuban Embassy searched by [redacted] and CASTRO's security guard with negative results. No pickets were observed at the Embassy and no incidents occurred endangering CASTRO.

b6
b7C

[redacted] advised CASTRO has personal body guards whom he described as "real hoodlums." Identified as [redacted] [redacted] Have appearance of [redacted] with [redacted] being larger of two. Stated [redacted] while observing pickets at Statler Hotel, 4/17/59, desired to attack approximately 250 anti-CASTRO pickets. Was restrained by [redacted] since [redacted] was armed and stated he would take care of at least ten pickets before they got him.

b6
b7C

- 3 - Bureau
- 1 - New York (Info) (RM)
- 1 - Miami (Info) (RM)
- 1 - WFO

b6
b7C

(6)

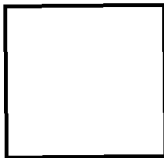

AIRTEL

Searched [redacted]
 Serialized [redacted]
 Indexed [redacted]
 Filed [redacted]

b3
b6
b7C
b7E

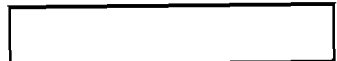

4/18/59

[redacted]

On 4/18/59, Captain [redacted] Special Services, MPD, advised CASTRO departed Cuban Embassy approximately 10:00 P. M. 4/17/59, rode to Haines Point, where he strolled for unknown period. Then returned to WDC where he appeared unannounced on STEVE ALLISON radio show. Returned to Embassy approximately 2:00 A. M., 4/18/59.

b3
b6
b7C
b7E

[redacted] advised information received Cuban Embassy purchased on 4/17/59, an additional eight .38 caliber revolvers which brings total purchased to 27.

Informants contacted 4/17 and 18/59, advised no incidents have occurred against CASTRO since referenced airtel.

On 4/18/59, [redacted] in addition advised SA [redacted] that [redacted] [redacted] Desires informant to continue [redacted] 4/17/59,

b6
b7C
b7D

[redacted] desired following information be furnished to SA [redacted] of Miami Office:

b6
b7C
b7D

[redacted]

b3
b7E

[Redacted]

[Redacted]

b7D

Information obtained of value to local authorities has been disseminated to them. Information obtained which would be of value to other government agencies submitted in form for dissemination.

Unless information of value obtained, a summary of activities for remainder of 4/18/59, and 4/19/59, will be submitted morning of 4/20/59.

Office Memorandum • UNITED STATES GOVERNMENT

TO : SAC, WFO [redacted]

DATE: 4/20/59

b3
b6
b7C
b7E

FROM : SA [redacted]

SUBJECT: FIDEL CASTRO

On the afternoon of 4/15/59, Supervisor [redacted] from the Bureau telephonically instructed that the following information be furnished to the various police agencies interested in CASTRO's visit to Washington, D. C.

b6
b7C

We have received information from a source whose reliability is unknown that [redacted]

b6
b7C
b7D

[Large redacted block]

SA [redacted] advised Detective [redacted] of the Metropolitan Police Department of the above.

b6
b7C

SA [redacted] advised Lieutenant [redacted] of the Fairfax County Police and Captain [redacted] of the Park Police of the above.

At 4:49 p.m., 4/15/59, I informed Supervisor [redacted] of the Bureau that the aforementioned officers of the respective police departments had been informed of the above.

b6
b7C

(1) - WFO

[redacted]

(1)

[redacted]

[redacted]	
SEARCHED [redacted]	INDEXED [redacted]
SERIALIZED [redacted]	FILED [redacted]
APR 20 1959	
FBI - WASH. F. O.	
[redacted]	

b3
b6
b7C
b7E

UNITED STATES DEPARTMENT OF JUSTICE

FEDERAL BUREAU OF INVESTIGATION
New York, New York

April 20, 1959

In Reply, Please Refer to
File No.

Re: Fidel Castro

NY T-1 advised on April 15, 1959, that he
has known Fidel Castro since 1945. [redacted]

NY T-1 stated that in 1945, when Fidel Castro
began his law studies, Castro manifested a great desire
to be the leader of the student body at the University
of Havana. The informant stated that Castro has always
had a consuming desire to be the most important individual
in anything which he has undertaken. He also stated that
Castro is the type of individual who would never let
anything or anyone stand in his way of achieving his
ultimate goal.

NY T-1 advised that [redacted]

b7D

b6
b7C
b7D

b3
b6
b7C
b7E

SEARCHED [redacted] INDEXED [redacted]
SERIALIZED [redacted] FILED [redacted]

APR 22 1959

NY T-1 further advised that during Castro's days at the University of Havana, Castro accepted and worked with the Communists who were in the University. The informant stated that it has never been definitely proven whether or not Castro was a member of the Communist Party, but it is a well-known fact that he has accepted aid from them and would use them in order to obtain his specific goals.

The informant also stated that [redacted]

[redacted]

b6
b7C
b7D

NY T-1 advised that while Fidel Castro was in the University of Havana, [redacted]

[redacted]

b6
b7C
b7D

NY T-1 advised that [redacted]

[redacted]

b6
b7C
b7D

[Redacted]

b6
b7C
b7D

Concerning the attack on the Moncada Barracks, which is in Santiago de Cuba, Cuba, the informant stated

[Redacted]

[Redacted] The informant stated that [Redacted]

b6
b7C
b7D

[Redacted]

The informant also stated that [Redacted]

b7D

[Redacted]

NY T-1 stated that Fidel Castro has always been an egotistical individual who has always sought power and

leadership and the type of individual who cannot stand any criticism of himself or his actions. The informant stated further that from his knowledge of Castro, Castro has never been a brave man and even during the fighting during the recent revolution, Fidel Castro did not engage in many skirmishes with the Cuban armed forces. The informant stated that Raul Castro and Major Ernesto "Che" Guevara, who are known and devoted Communists, have great influence over Fidel Castro.

NY T-1 also advised that it is quite evident in the new Cuban government how the Communists control many important posts and influence decisions of the new government. The informant stated that immediately after Batista fled Cuba on January 1, 1959, the Communist Party, which is well organized and disciplined in Cuba, emerged as a most important factor in the formation of Castro's government. The informant stated further that from individuals such as [redacted] and Ernesto Guevara, it is quite evident that the Cuban government, unless stopped, will be completely Communistic. NY T-1 stated that in addition to [redacted] and Ernesto Guevara, Castro has the following individuals close to him:

b6
b7C

b6
b7C
b7D

Concerning the July 26th Movement, it is noted

that this movement was started by Fidel Castro when he made his abortive attack against the Moncada Barracks on July 26, 1953, from which his organization has taken its name.

This document contains neither recommendations nor conclusions of any kind. It is the property of the FBI, and is a loan to your agency; it and/or its contents are not to be distributed outside your agency.

UNITED STATES DEPARTMENT OF JUSTICE
FEDERAL BUREAU OF INVESTIGATION
New York, New York

In Reply, Please Refer to
File No.

April 20, 1959

Re: Fidel Castro

Reference is made to New York memorandum dated and captioned as above.

NY -T-1, mentioned in attached memorandum, is an informant who was in a position to furnish reliable information but whose reliability has not yet been determined due to insufficient contact.

This document contains neither recommendations nor conclusions of any kind. It is the property of the FBI, and is a loan to your agency; it and/or its contents are not to be distributed outside your agency.

[Redacted]	
SEARCHED.....	INDEXED.....
SERIALIZED.....	FILED.....
APR 22 1959	
F. O. [Redacted]	

b3
b6
b7C
b7E

4/20/59

AIRTEL

TO: DIRECTOR, FBI [redacted]
 FROM: SAC, NEW YORK [redacted]
 SUBJECT: FIDEL CASTRO
 [redacted]

b3
b7E

Enclosed herewith for the information of the Bureau are 11 copies of a letterhead memorandum and 11 copies of a reliability memorandum setting forth reliability of informant used.

NY T-1, mentioned in enclosed memorandum, is [redacted]

b7D

[redacted]

[redacted] was most cooperative during this interview on 4/15/59, and indicated his desire to cooperate with this Bureau in any way he could. A separate communication under the caption of [redacted] will be submitted requesting Bureau permission to recontact [redacted] as a potential security informant.

b7D

- 3 - Bureau [redacted] (Encls. 22) (RM)
- 1 - Miami (Encls. 2) (Info) (RM)
- ① - Washington Field (Encls. 2) (Info) (RM)
- 1 - New York [redacted]
- 1 - New York [redacted]

b3
b6
b7C
b7E

[redacted]

(8)

[redacted]

SEARCHED [redacted] INDEXED [redacted]
 SERIALIZED [redacted] FILED [redacted]

APR 22 1959

[redacted]

[Redacted]

b3
b7E

Date: April 20, 1959

To: Mr. E. Tomlin Bailey
Director
Office of Security
Department of State
515 22nd Street, N. W.
Washington 25, D. C.

From: John Edgar Hoover, Director
Federal Bureau of Investigation

Subject: FIDEL CASTRO

[Redacted]

b3
b7E

Reference is made to this Bureau's letter dated April 15, 1959, captioned as above.

A representative of the New York City Police Department advised our New York Office on April 17, 1959, that a group composed mostly of Dominican nationals left New York City in five Greyhound buses at 7:45 a.m., April 17, 1959, for Washington, D. C., where they planned to picket Fidel Castro. According to the New York City Police Department, more than one hundred individuals who planned to make the trip were left behind because there were not sufficient buses. [Redacted] was in charge of the pickets and reportedly told the New York City Police Department that they were being hired through the Dominican Consulate, New York City. The New York City Police Department also learned the pickets intended to return to New York City in the late evening of April 17, 1959.

b6
b7C

The above confirms information furnished orally to [Redacted] in the office of [Redacted] Department of State, by Special Agent [Redacted] of this Bureau on April 17, 1959.

b6
b7C

[Redacted]

b3
b6
b7C
b7E

1 - Havana
① - WFO

[Redacted]

SEARCHED _____ INDEXED _____
SERIALIZED _____ FILED _____
MAY 19 1959

[Redacted]

Mr. E. Tomlin Bailey

b3
b7E



April 17, 1959

AIRTEL

To: SAC, San Antonio

From: Director, FBI

PIDEL CASTRO

[Redacted]

b3
b7E

"The San Antonio Express" for April 10, 1959, reported that Fidel Castro may go to San Antonio to witness its Fiesta San Jacinto celebration.

For the information of San Antonio, a New York source has learned that there is allegedly a definite plan to kill Castro when he comes to the United States. The source did not know where this attack would take place nor the identity of the participants.

Enclosed for San Antonio is a copy of Bulletin to State Department 4/9/59 together with two copies each of photographs of [Redacted] and [Redacted]

[Redacted]

b6
b7C

San Antonio will immediately furnish the information given by the New York source, the information in Bulletin to State Department 4/9/59, and one copy of each of the enclosed photographs to the local police. The same source who furnished the information in Bulletin to State 4/9/59 furnished the photographs.

Enclosures - 5

- 1 - Boston
- 1 - Miami
- 1 - Newark
- 1 - New York
- 1 - New Orleans
- 1 - Houston
- 1 - Washington Field

[Redacted]

SEARCHED [] INDEXED []
 SERIALIZED [] FILED []

APR 20 1959

[Redacted]

b3
b6
b7C
b7E

**Airtel to San Antonio
Re: Fidel Castro**

San Antonio should be alert for any data indicating subversives or anti-Castro demonstration may be fomented and any data indicating a threat to Castro's personal safety or that of his group. Sources and informants in a position to acquire this data should be alerted to the necessity for prompt reporting. The Bureau should be promptly advised of any pertinent data received and any indication of violence against Castro and members of his group should, in addition, be furnished local police authorities.

[Redacted]

b3
b7E

Date: April 20, 1959

To: Mr. E. Tomlin Batley
Director
Office of Security
Department of State
515 22nd Street, N. W.
Washington, D. C.

From: John Edgar Hoover, Director
Federal Bureau of Investigation

Subject: FIDEL CASTRO

[Redacted]

b3
b7E

This will confirm information furnished orally to [Redacted] of your Department by Special Agent [Redacted] of this Bureau on the morning of April 19, 1959.

b6
b7C

On April 19, 1959, Charles Roing Dyer, Jr., Maple Lodge, 107 Fifth Street, Pulaski, Virginia, advised this Bureau as follows:

Dyer is a free-lance newspaperman who is not presently connected with any newspaper or syndicate. Earlier in 1959 he met a Cuban named [Redacted] when [Redacted] stopped in Pulaski, Virginia, to purchase gasoline. After talking to [Redacted] Dyer became interested in Fidel Castro and came to Washington, D. C., on the evening of April 16, 1959, to cover Castro's visit. He met one of Castro's bodyguards, [Redacted] on April 17, 1959, and was casually invited to the reception at the Cuban Embassy, Washington, D. C., on the night of April 17, 1959, by [Redacted]. Dyer appeared at the reception and was approved for admittance by [Redacted] of the Department of State. Dyer was able to speak briefly with Fidel Castro during the reception.

b6
b7C

- 1 - Havana
- 2 - Richmond - See note page 2
- ② - WFO - See note page 2

[Redacted]

SEARCHED	INDEXED
SERIALIZED	FILED
APR 22 1959	
FBI - WASH. F.	

[Redacted]

b3
b6
b7C
b7E

Mr. E. Pomlin Bailey

Dyer exhibited some handwritten notes which he had addressed to [redacted] who, according to Dyer, is residing at the Statler Hilton Hotel, Washington, D. C. One of the items indicated Dyer had overheard a "man connected with the Washington Police Department" say Castro was actually residing at the Statler Hilton Hotel and not the Cuban Embassy as newspapers have reported. This item indicated Castro was using a secret entrance at the hotel. In another item Dyer had written that he overheard a Washington, D. C., policeman state he had to go to New York to help protect Castro and this policeman was not happy. A third item concerned information to the effect that Dyer overheard a man who used the name [redacted] (or [redacted]) say over the telephone that he was going off duty and that Castro was probably already with "some woman" at that time.

b6
b7c

Dyer said he wanted to check with the FBI and the Department of State concerning whether he should give the notes to [redacted]. He was advised the FBI could give him no advice in the matter. He said he planned to check with the Department of State at a later hour on April 19, 1959. The files of this Bureau contain no identifiable information concerning Dyer and we contemplate taking no further action concerning the material exhibited by Dyer.

b6
b7c

Note to SACs, Richmond and WFO:

Dyer appeared at the Bureau at 5:55 a.m. 4/19/59. He carried identification papers showing he was born 4/22/15, Pulaski, Virginia, has Social Security Number 227-14-1886, Virginia Automobile Operator's Permit Number 716908 and owns a 1958 Chevrolet bearing Virginia License Number 833099. He said he is divorced. He had in his possession a letter from the Pulaski, Virginia, Police Department which indicated he is a legitimate writer and is in good standing with that Department. He claimed he had contributed articles to many southern newspapers within the past 2 years, including the Pulaski "Daily Times." Dyer denied he had been asked by [redacted] or any representative of the Cuban Government to report anti-Castro information to [redacted]. The provisions of the Foreign Agents Registration Act were cited to Dyer. Advise Bureau if information is received indicating Dyer is acting on behalf of the Cuban Government.

b6
b7c

~~CONFIDENTIAL~~

b3
b7E

Washington 25, D.C.
April 20, 1959

FIDEL CASTRO

On April 17, 1959, a confidential informant,
who has furnished reliable information in the past,
advised [redacted]

[redacted]

b3
b7E

The informant also advised that [redacted]

[redacted]

b3
b7E

According to the informant, [redacted]

[redacted]

b3
b7E

The informant also advised that [redacted]

[redacted]

b3
b7E

5-Bureau [redacted]

②-WFO [redacted]

[redacted]

(7) [redacted]

[redacted]

b3
b6
b7C
b7E

Searched [redacted]
Serialized [redacted]
Indexed [redacted]
Filed [redacted]

~~CONFIDENTIAL~~

~~CONFIDENTIAL~~

Re: FIDEL CASTRO

~~CONFIDENTIAL~~

On April 18, 1959, the informant advised that

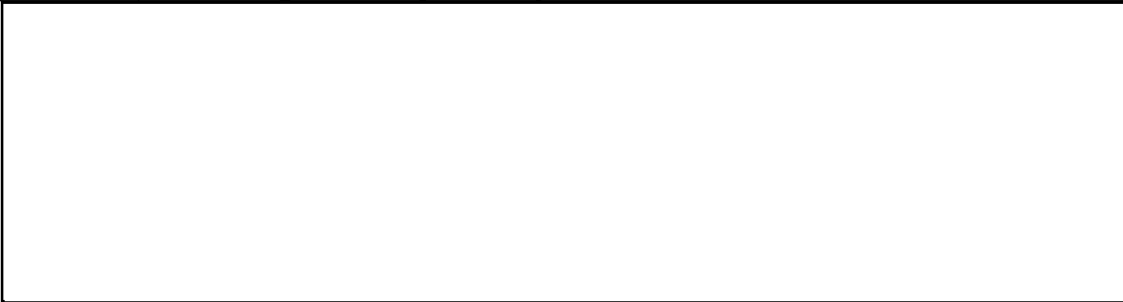

b3
b6
b7C
b7E

This memorandum is loaned to you by the Federal Bureau of Investigation and neither it nor its contents are to be distributed outside the agency to which loaned.

~~CONFIDENTIAL~~

4/20/59

AIRTEL

TO: DIRECTOR, FBI [redacted]

b3
b7E

FROM: SAC, WFO [redacted]

FIDEL CASTRO

[redacted]

Enclosed for the Bureau are five copies of a letterhead memo dated 4/20/59.

The information in enclosed letterhead memo was furnished by [redacted] on 4/17/59.

b3
b7E

The enclosed memo is classified "~~confidential~~"

[redacted]

[redacted] and since the data reported could reasonably result in identification of a confidential informant of continuing value and compromise the future effectiveness thereof.

2-Bureau (Encls. 5) *sent 4/20*
2-WFO

[redacted]

[redacted]

(5) [redacted]

[redacted]

b3
b6
b7C
b7E

AIRTEL

Searched [redacted]
Serialized [redacted]
Indexed [redacted]
Filed [redacted]

b3
b6
b7C
b7E

[redacted]

April 20, 1959

AIRTEL

TO: DIRECTOR, FBI [redacted]

FROM: SAC, WFO [redacted]

b3
b7E

FIDEL CASTRO RUZ
[redacted]

Remyairtel 4/18/59.

Diplomatic reception held as scheduled Cuban Embassy 4/18/59. No incidents occurred.

At 1:30 A.M. 4/19/59 CASTRO, accompanied by four CASTRO followers, State Security guards and Metropolitan Police Department (MPD) officers, departed Cuban Embassy by rear door and travelled to 1816 M Street, N. W., Washington, D. C. CASTRO stayed in this building until approximately 5:00 A.M., at which time he returned to Cuban Embassy. This address is old residence which has been converted to some office space and some apartments. State Security men and MPD officers believed from conversation of CASTRO followers that CASTRO at above address with female companion per previous arrangements.

At approximately 1:55 A.M. [redacted] advised

b3
b6
b7C
b7E

- 3 - Bureau
- 1 - Miami (Info)(RM)
- 1 - Newark (Info)(RM)
- 1 - New York (Info)(RM)
- (1) - WFO

(7) [redacted]

A I R T E L

[Handwritten signature]

Searched _____
 Serialized [redacted]
 Indexed _____
 Filed [redacted]

b3
b6
b7C
b7E

[redacted]

[redacted]

b3
b6
b7C
b7E

[redacted]

[redacted] advised Special Agent [redacted]
[redacted] 4/20/59 that [redacted]

b6
b7C
b7D

[redacted] No listing with [redacted] Washington,
D. C., telephone and address telephone directories for
[redacted]

No record WFO indices for [redacted]
[redacted] In view of above information, no additional
investigation to be conducted re these persons by WFO.

b6
b7C

At 9:40 A.M. CASTRO departed Washington, D. C.,
for Mount Vernon and returned at 11:45 A.M. He visited
Lincoln Memorial and Jefferson Memorial, returning to Cuban
Embassy approximately 12:30 P.M.

He departed Cuban Embassy approximately 5:00 P.M.
with [redacted] thereafter appearing on "Meet the Press".
At conclusion this program he went directly to Capitol Building,
arriving approximately 7:00 P.M. He conferred with Vice
President RICHARD M. NIXON until 9:30 P.M. and returned
Cuban Embassy approximately 9:45 P.M. No incidents concerning
CASTRO on 4/19/59.

b6
b7C

[redacted] advised Special Agent [redacted]
[redacted]

b6
b7C
b7D

Special Agent [redacted]
[redacted] and noted that neither MPD or State Security
was aware of this. Immediately told MPD and State Security

b6
b7C
b7E

[redacted]

b3
b6
b7C
b7E

men that an anti-CASTRO man whom Special Agent [redacted] had observed in picket lines had entered Cuban Embassy. Security men entered Embassy with MPD and stated they had found informant in a "back room" surrounded by CASTRO bodyguards. Bodyguards indicated they would "take care" of [redacted] but Security men insisted he be released since would work to disadvantage of Cuban Government. [redacted] was escorted from building and proceeded south on 16th Street. [redacted]

[redacted] who desired to attack approximately 250 anti-CASTRO pickets on 4/17/59, left Embassy and started after [redacted] and indicated he was going to shoot him. Was physically restrained by fellow Cubans, thereby avoiding incident.

Captain [redacted] MPD, advised he was made aware of the above situation by his detectives and has stated that he will not allow [redacted]

b6
b7C
b7E

[redacted] in vicinity of National Press Club 4/20/59 since [redacted] fears Cuban followers will attempt to create incident concerning both [redacted]

In view of above, WFO feels [redacted]

[redacted]

b6
b7C
b7D
b7E

On 4/19/59 Captain [redacted] telephonically advised that [redacted] advised [redacted] that one busload of anti-CASTRO pickets would depart New York City and arrive Washington, D. C., approximately 11:00 A.M. 4/20/59. [redacted] plans to keep this group completely separated from any pro-CASTRO pickets which should appear at subject's appearance at National Press Club this date. It is noted that [redacted] has told [redacted]

b6
b7C
b7D

[redacted]

CASTRO still scheduled to leave Washington, D. C., 4:00 P.M. by Pennsylvania Railroad for Princeton, New Jersey.



b3
b7E

Close liaison being maintained with local authorities and information of value being furnished them on current basis.

Bureau will be advised of future developments.

April 20, 1959

AIRTEL

TO: DIRECTOR, FBI [redacted]
FROM: SAC, WFO [redacted]
EDEL CASTRO RUZ
[redacted]

b3
b7E

Re my airtel 4/20/59.

CASTRO visited Arlington Cemetery this A.M.; attended luncheon National Press Club. Fifty tickets from New York City, led by [redacted] arrived Washington, D. C., by bus; departed approximately 2:15 P.M. for New York City.

b6
b7C

CASTRO and party of approximately 35 departed Union Station, Washington, D. C., 4:02 P.M. 4/20/59 aboard Pennsylvania Railroad Train 152, the Afternoon Congressional. Party occupying last two cars on train. Train to make special stop Princeton, New Jersey, arriving 6:50 P.M.

Unverified information from [redacted] indicates [redacted]

b3
b7E

- 3 - Bureau
- 1 - Boston (Info)(RM)
- 1 - Miami (Info)(RM)
- 1 - Newark (Info)(RM)
- 1 - New York (Info)(RM)
- 1 - WFO
- (8) [redacted]

b6
b7C

A I R T E L

Inspector [redacted] office telephonically advised of CASTRO's departure 4:15 P.M. by SA [redacted]

[redacted]

Searched _____

Serialized _____

Indexed _____

Filed _____

b3
b6
b7C
b7E

[redacted]

b3
b7E

[redacted]

For info other offices, only possible incidents
Washington, D. C., involved activities of [redacted]

[redacted] who is hot-head and desired
to attack 250 anti-CASTRO pickets on 4/17/59 and attempted
to chase and possibly shoot [redacted]

b6
b7C
b7E

[redacted] has restrained physically
on both occasions.

[redacted]

[redacted] advised

[redacted]

b6
b7C
b7D

CASTRO party is accompanied by following men
from Security Office, State Department, Washington, D. C.:

[redacted]

b6
b7C

CASTRO tentatively to depart Princeton, New Jersey,
9:50 A.M. 4/21/59 and arrive New York City 4/21/59 at
10:45 A.M.

Newark and New York Office cognizant of above.

No incidents Washington, D. C. Info of interest
to other Government agencies will be submitted in form
suitable for dissemination.

4/21/59

AIRTEL

Registered Mail

TO: DIRECTOR, FBI [redacted]
FROM: SAC, NEWARK [redacted]
SUBJECT: FIDEL CASTRO
 [redacted]

b3
b7E

Re WFO airtel to Bureau dated 4/20/59.

CASTRO arrived Princeton, NJ, aboard Pennsylvania Railroad 6:52 PM, 4/20/59, and escorted by NJSP to home of [redacted] Princeton, NJ, where he was to be a guest.

b6
b7C

At approximately 8:15 PM, CASTRO arrived Woodrow Wilson Hall, Princeton University, for scheduled speech. Upon arrival was greeted by enthusiastic and unruly crowd of college students, approximately 1,000 in number, who attempted to engulf the official party prior to their entry into the building. NJSP opened a lane to the door of the building and all members of the official party were able to enter building. No incidents were noted and no injuries received by anyone in official party. CASTRO spoke approximately two hours, then departed from building by back door. He objected to this procedure and insisted that he be driven to front of building where approximately 200 students had gathered so that he might speak to them. He spoke to these students for approximately five minutes, then was escorted to the residence of Governor MEYNER of New Jersey.

CASTRO arrived at Governor MEYNER's residence shortly after 10 PM and attended an informal reception. Noted at this reception were DEAN LACHESON, former Secretary of State, and [redacted] Princeton University, as well as Governor and Mrs. MEYNER. He departed from Governor's residence approximately 11:30 PM and spent night in guest house of [redacted]

b6
b7C

- 3 - Bureau
- 1 - New York (Info)
- 1 - WFO (Info)
- 1 - Newark

[redacted]

(6)

[redacted]

SEARCHED _____ INDEXED _____
 SERIALIZED _____ FILED _____
 APR 22 1959
 FBI - NEWARK, N. J.

[redacted]

b3
b6
b7C
b7E

[Redacted]

b3
b7E

On 4/21/59, CASTRO spoke to students at Lawrenceville Prep School, Lawrenceville, NJ, approximately 20 minutes, then departed for Pennsylvania Railroad station, Princeton Junction, NJ. Boarded Pennsylvania Railroad train, Princeton Junction, NJ, 9:50 AM, due to arrive 10:45 AM, NYC.

Major [Redacted] NJSP Headquarters, Trenton, NJ, was kept advised of all pertinent information of value in this matter. Also, liaison was maintained with local police departments and State Department personnel.

b6
b7C

No incidents of any kind occurred during visit to Princeton, NJ.

Letterhead memorandum to follow.

4/21/59

Airtel

To: SAC, Miami

From: Director, FBI [redacted]

Subject: EIDEL CASTRO
[redacted]

b3
b7E

ReWFO airtel 4/18/59 advising [redacted] desired certain information furnished to SA [redacted] of Miami Office.

b6
b7C
b7D

Subairtel identity of [redacted] and advise what investigation is being conducted concerning him by your office.

1 - New York
① - WFO [redacted]

b3
b7E

b3
b6
b7C
b7E

[redacted]

SEARCHED	INDEXED
SERIALIZED	FILED
APR 21 1959	
F. O. [redacted]	

April 21, 1959

ANTI-FIDEL CASTRO ACTIVITIES

On April 14, 1959, a source of information whose reliability is not known, but who has a wide acquaintance among Latin-Americans in Washington, D. C., furnished the following information:

The informant stated

[Redacted]

b6
b7C
b7D

The informant stated that on Sunday, April 11, 1959,

[Redacted]

b6
b7C
b7D

Searched _____
Serialized _____
Indexed _____
Filed _____

[Redacted]

b3
b6
b7C
b7E

[Redacted]

RE: ANTI-FIDEL CASTRO ACTIVITIES

[REDACTED]

b6
b7C
b7D

On April 19, 1959, [REDACTED]

[REDACTED]

b6
b7C
b7D

On April 21, 1959, the same source of information advised that [REDACTED] on the previous day. He learned that [REDACTED]

b6
b7C
b7D

[REDACTED]

This memorandum is loaned to you by the Federal Bureau of Investigation, and neither it nor its contents are to be distributed outside the agency to which loaned.

4/21/59

AIRTEL

TO: DIRECTOR, FBI [redacted]

b3
b7E

FROM: SAC, WFO [redacted]

ANTI-PIDEL CASTRO ACTIVITIES

[redacted]

There are attached for the Bureau five copies, for Miami one copy, and for NY two copies of a letterhead memo reflecting info received from [redacted] (PSI) who furnished info contained in WFO airtel 4/15/59 and also furnished info to WFO on 4/21/59.

b6
b7C
b7D

[redacted] indicated he intended to [redacted] and thereafter would advise WFO of any info obtained.

- 3 - Bureau (Encls. 5)
- 1 - Miami (Encl. 1)(Info)(RM)
- 2 - New York (Encls. 2)(Info)(RM)
- ② - WFO

[redacted] (CASTRO)

b3
b6
b7C
b7E

[redacted]
(9)



AIRTEL

Searched [redacted]
 Serialized [redacted]
 Indexed [redacted]
 Filed [redacted]

b3
b6
b7C
b7E



4/22/59

AIRTEL

TO : DIRECTOR, FBI [redacted]
FROM: SAC, NEW YORK [redacted]
 WIDEL CASTRO
 [redacted]

b3
b7E

Detective [redacted] BSS, NYCPD, advised on 4/21/59 that CASTRO and his party arrived in Penn Station at approximately 11:07 A.M. and was greeted by an unruly crowd of approximately 20,000 people. [redacted] advised that, upon his arrival in New York, he immediately went to his hotel suite at the Statler Hotel, which is in Room 1710-1712A. [redacted] advised that CASTRO then proceeded in the afternoon to Columbia University where he addressed a student group and was at the "New York Times" for a meeting with editors of the "Times" which began at approximately 3:30 P.M.

b6
b7C

[redacted]

b6
b7C
b7D

- 3 - Bureau [redacted] (RM)
- 1 - Boston (RM) (INFO)
- 1 - Miami (RM) (INFO)
- ① - Washington Field (RM) (INFO)
- 1 - New York [redacted]

b3
b7E

[redacted]
 (8)

b3
b6
b7C
b7E

[redacted]

SEARCHED	INDEXED
SERIALIZED	FILED
APR 23 1959	

[redacted]

[Redacted]

b3
b7E

[Redacted]

b6
b7C
b7D
b7E

[Redacted]

Student
LIFE, City College of New York, advised 4/22/56 that FIDEL
CASTRO will speak on 4/25/56 at City College from 9:00 A.M.
to 12 noon in John H. Findlay Student Center, 132nd Street
and Convent Avenue, NYC.

b6
b7C

The above information will not be submitted in a
form suitable for dissemination because [Redacted]

b7D
b7E

[Redacted]

and the source could be compromised UACB.

C

Director, FBI [redacted]

April 14, 1959

Legat, Havana [redacted]

FIDEL ALEJANDRO CASTRO RUIZ

[redacted]

b3
b7E

Re Havana letter dated April 10, 1959.

Concerning FIDEL CASTRO's proposed trip to the United States, the Embassy has been unable to obtain from the Cuban Foreign Office a list of individuals who will accompany CASTRO and his complete itinerary. This office through [redacted] sources has been able to identify the following persons as some of those who will accompany CASTRO. This, however, is by no means a complete list as it is reported that approximately 90 persons will be with CASTRO on his trip which will be taken via a chartered Cubana "Britannia" airliner. In addition to [redacted] mentioned in relet, the following will also accompany CASTRO:

b3
b6
b7C
b7E

[Large redacted area]

b6
b7C

Extra copies of this letter have been prepared for forwarding by the Bureau to the New York and Washington Field offices.

6 - Bureau (2-cc: New York and WFO)
1 - Havana

[redacted]

(7)

[redacted]
SEARCHED [redacted] INDEXED [redacted]
SERIALIZED [redacted] FILE [redacted]
APR 23 1959
[redacted]

b3
b6
b7C
b7E

Date _____

SAC: WFO _____ Field Office

Re: _____

The enclosed is for your information. If used in a future report conceal all sources, paraphrase contents.

Enclosed are corrected pages from report of SA _____ dated _____

For information.

For appropriate action.

Remarks:

1. 2

Enclosure(s)

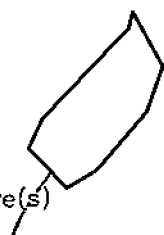

SEARCHED		INDEXED	
SERIALIZED		FILED	
APR 23 1959			

b3
b6
b7C
b7E



UNITED STATES DEPARTMENT OF JUSTICE
FEDERAL BUREAU OF INVESTIGATION

In Reply, Please Refer to
File No.

WASHINGTON 25, D. C.

April 23, 1959

FIDEL CASTRO

The Confidential Informant, mentioned in the letterhead memorandum is in a position to comment about Cuban activities; however, he has not been contacted a sufficient number of times to evaluate his reliability.

This memorandum is loaned to you by the Federal Bureau of Investigation, and neither it nor its contents are to be distributed outside the agency to which loaned.

- 5 - Bureau [redacted]
- 1 - Miami (Info) (RM)
- 1 - New York (Info) (RM)
- 2 - WFO [redacted]

b3
b6
b7C
b7D
b7E

[redacted]

(9)

[redacted]

93

Searched
Serialized
Indexed
Filed

[redacted]

b6
b7C

~~CONFIDENTIAL~~

b6
b7C



UNITED STATES DEPARTMENT OF JUSTICE
FEDERAL BUREAU OF INVESTIGATION

WASHINGTON 25, D. C.

In Reply, Please Refer to
File No.

April 23, 1959

FIDEL CASTRO

On April 15, 1959, a Confidential Informant contacted a Special Agent of the Federal Bureau of Investigation, Washington, D.C., and advised that [redacted]

b7D

[redacted]

On April 16, 1959, the informant advised that [redacted]

b6
b7C
b7D

[redacted]

On April 17, 1959, the informant advised [redacted]

b7D

[redacted]

- 5 - Bureau [redacted]
- 1 - Miami (Info) (RM)
- 1 - New York (Info) (RM)
- ② - WFO [redacted]
- (1 - [redacted])

[redacted]

b3
b6
b7C
b7D
b7E

WFO copy

(9)

Searched _____

Serialized _____

Indexed _____

Filed _____

~~CONFIDENTIAL~~

[redacted]

~~CONFIDENTIAL~~

FIDEL CASTRO

On April 18, 1959, the informant advised [redacted]

b7D

[redacted]

On April 20, 1959, the informant mentioned that

[redacted]

b6
b7C
b7D

The informant also stated that [redacted]

[redacted]

The informant concluded by stating that [redacted]

b6
b7C
b7D

[redacted]

This memorandum is loaned to you by the Federal Bureau of Investigation and neither it nor its contents are to be distributed outside the agency to which loaned.

~~CONFIDENTIAL~~

4/23/59

AIRTEL

TO: DIRECTOR, FBI [redacted]

b3
b7E

FROM: SAC, WFO [redacted]

FIDEL CASTRO
[redacted]

Enclosed are five copies for the Bureau, one to Miami, and one to New York, for information, of a letterhead memo and an equal number of letterhead memos evaluating the informant mentioned therein, dated 4/23/59.

The information in enclosed memo was furnished by [redacted] a PSI of WFO, to SA [redacted] on the dates indicated.

b6
b7C
b7D

The enclosed memo is classified "~~Confidential~~"

[redacted] and since data reported could reasonably result in the identification of a Confidential Informant of continuing value and compromise the future effectiveness thereof.

b3
b7E

- 3 - Bureau (Encls. 10)
- 1 - Miami (Encls. 2) (Info) (RM)
- 1 - New York (Encls. 2) (Info) (RM)
- ② - WFO

Next 4-22

[redacted]
[redacted]
[redacted]
(7) done

b3
b6
b7C
b7D
b7E

Searched [redacted]
Serialized [redacted]
Indexed [redacted]
Filed [redacted]

b3
b6
b7C
b7E

[redacted]

~~CONFIDENTIAL~~

April 24, 1959

FIDEL CASTRO

On April 24, 1959, a confidential informant, whose reliability is not known but who has a wide acquaintance among Latin American individuals in Washington, D.C., furnished the following information:

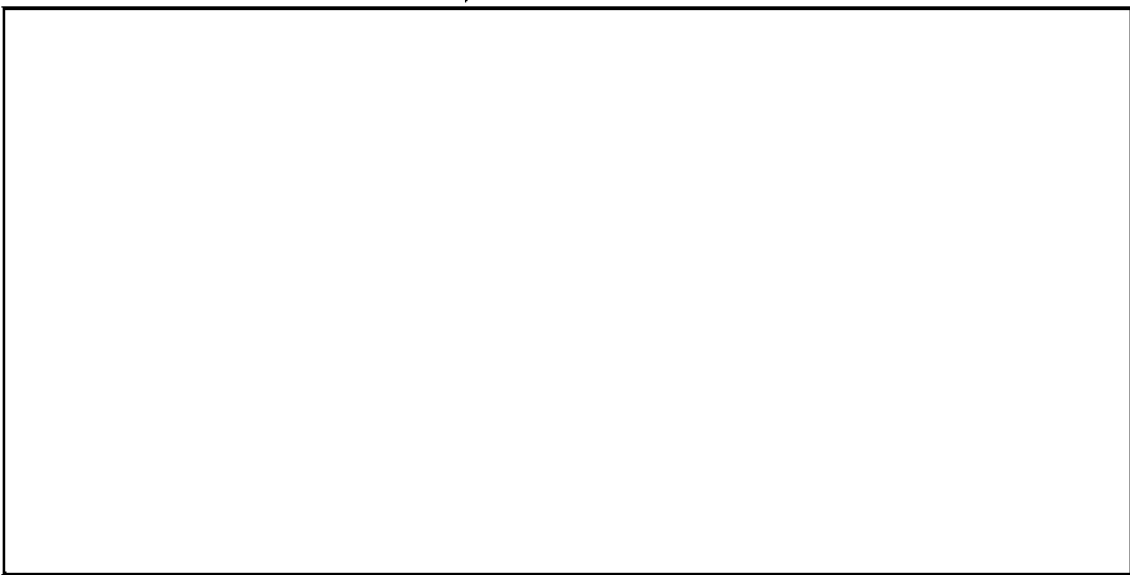

b6
b7C
b7D

This memorandum is loaned to you by the Federal Bureau of Investigation and neither it nor its contents are to be distributed outside the agency to which loaned.

- 5- Bureau
- 2- New York
- 1- Boston (Info)
- 1- Miami (Info)
- 2- WFO

(11)



b3
b6
b7C
b7D
b7E

~~CONFIDENTIAL~~

Searched

Serialized

Indexed

Filed

b3
b6
b7C
b7E

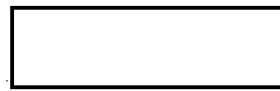

4/24/59

AIRTEL

TO: DIRECTOR, FBI

FROM: SAC, WFO [redacted]

b3
b7E

FIDEL CASTRO
[redacted]

Attached for the Bureau are five copies, for New York two copies, and one copy each for Boston and Miami of a letterhead memorandum reflecting information received from [redacted] PSI. [redacted] is attempting to obtain additional information regarding this matter and will advise WFO.

b6
b7C
b7D

New York advised telephonically and requested, along with Boston, to advise local PDS.

Attached memorandum is classified "~~Confidential~~"

[redacted]

b3
b7E

- 3- Bureau (Encls. 5)
- 2- New York (Encls. 2)
- 1- Boston (Encl. 1)(Info)
- 1- Miami (Encl. 1)(Info)
- 2- WFO

sent 4/24/59. RM

[redacted]

(9)

[redacted]

b3
b6
b7C
b7D
b7E

[redacted]

Searched [redacted]
Serialized [redacted]
Indexed [redacted]
Filed [redacted]

b3
b6
b7C
b7E

[redacted]

4/22/59

PLAIN TEXT

AIRTEL

AIR MAIL

TO: DIRECTOR, FBI
FROM: SAC, SAN ANTONIO [redacted]
RE: FIDEL CASTRO
[redacted]

b3
b7E

Re Bureau airtel to San Antonio dated 4/17/59.

On 4/20/59, [redacted]

b6
b7C

[redacted] advised SAC L. FLAYLOCK that FIDEL CASTRO, Prime Minister of Cuba has been invited by the San Antonio Press Club to come to San Antonio for the Fiesta Week beginning 4/20/59. [redacted] stated that it is very doubtful that CASTRO will be able to visit San Antonio due to his schedule, however, CASTRO might possibly make a quick visit to San Antonio at the end of the Fiesta Week 4/25/59. [redacted] reiterated that it is very doubtful CASTRO will make such a visit to San Antonio.

Captain [redacted] (NA), was furnished information in referenced airtel and information contained in enclosed letter from Director to Office of Security, Department of State dated 4/9/59. Captain [redacted] was also furnished two copies of photographs received.

b6
b7C

Logical informants in this matter were also alerted.

The Bureau will be immediately advised of any further developments.

- 3 - Bureau
- 1 - Houston (Info)
- 1 - Washington Field (Info)
- 1 - San Antonio

(6)

AIR TEL

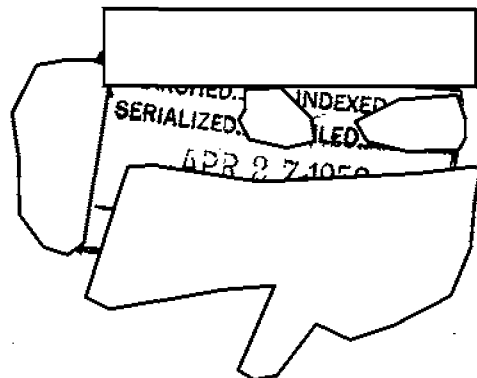

b3
b6
b7C
b7E



b3
b7E

Copies of this airtel are being furnished to
Houston and Washington Field for informational purposes.

- RUC -

END

BLAYLOCK

4/23/59

AIRTEL

TO : DIRECTOR, FBI [redacted]

FROM: SAC, NEW YORK [redacted]

FIDEL CASTRO
[redacted]

b3
b7E

On 4/23/59, CASTRO, during A.M., visited Mayor WAGNER at City Hall and thereafter attended luncheon of Overseas Press Club at Sheraton Astor Hotel. CASTRO is scheduled to speak at 5:30 P.M., 4/23/59 at Council on Foreign Relations, 58 East 68th Street, NYC.

On 4/24/59, CASTRO will speak at 8:50 P.M. at Central Park Mall. NYCPD will employ 1,000 patrolmen and 300 detectives in maintaining security precautions.

On 4/25/59, CASTRO will depart at 11:00 A.M. for Boston from Pennsylvania Railroad Station, utilizing the three rear cars, possibly on Train #188. He will arrive Back Bay Station, 3:35 P.M., and will stay at Sheraton Plaza Hotel. At 6:25 P.M., this date, he will attend a cocktail and dinner party at Faculty Club, Quincy Street, Massachusetts. Three hundred people are expected to attend. At 8:15 P.M., CASTRO will speak at Dillen Field House, Harvard University, before six to ten thousand people. At 11:00 P.M., he will return to Faculty Club for reception prior to return to hotel.

- 3- Bureau [redacted] (RM)
- 1- Boston (INFO)(RM)
- 2- New Haven (INFO)(RM)
- ① Washington Field (INFO)(RM)
- 1- New York [redacted]

b3
b6
b7C
b7E

[redacted]
(8)

[redacted]

SEARCHED	INDEXED
SERIALIZED	FILED
APR 27 1959	

[redacted]

[redacted]

On 4/26/59, CASTRO will depart Logan Airport at 10:00 A.M. via Canadian Air Force plane. Arrangements being handled by [redacted] CASTRO expects to cut short his Canadian visit as he is scheduled to be in Havana no later than 5/1/59. While in New York, CASTRO has been in the company of [redacted] who is from Havana.

b3
b6
b7C
b7E

The above information furnished through police liaison. There had been a rumor that CASTRO may check off to Connecticut during the night of 4/23/59, and NYCPD cognizant, is attempting to check this matter out and contemplating alerting Connecticut State Police and town police where necessary.

No incidents occurred during CASTRO'S visit on 4/23/59. above furnished for information of interested offices.

Office Memorandum • UNITED STATES GOVERNMENT

TO : SAC, Washington Field

DATE: April 28, 1959

FROM : Director, FBI [redacted]

b3
b7E

SUBJECT: FIDEL CASTRO
[redacted]

In connection with numerous communications submitted by your office as an outgrowth of subject's recent visit to Washington, D. C., under the caption of this letter as well as under the captions "Anti-Fidel Castro Activities" and [redacted] it is noted that in many instances these communications and the letterhead memoranda enclosed with them have made reference to various individuals and organizations which are of interest to New York and Miami, in some cases subjects of pending investigations by those offices. For example, a number of references are contained in these communications regarding [redacted] at [redacted] both New York City and Miami.

b3
b6
b7C
b7E

New York and Miami should carefully review all of the communications submitted by WFO in connection with subject's recent visit to Washington, D. C., to insure that, where warranted, pertinent data regarding subjects of other investigations is appropriately reported under the individual case caption involved.

Particular reference is directed to WFO airtel 4/15/59 captioned [redacted] with enclosure, which contains information to the effect that [redacted] was apparently endeavoring to obtain financial assistance from one [redacted] of NYC. This individual may be identical with [redacted] NYC. WFO and New York should be particularly alert for any indication that [redacted] [redacted] are furnishing support for anti-Castro activities, financial or otherwise. If such information should be received, the Bureau should be promptly advised and consideration should be given to requesting the Bureau to obtain clearance for active investigation [redacted].

b3
b6
b7C
b7E

- 2 - Miami
- 2 - New York

[redacted]
SEARCHED.....INDEXED.....
SERIALIZED.....FILED.....
APR 29 1959
[redacted]

b3
b6
b7C
b7E

4-24-59

PLAIN TEXT

AIRTEL

AIR MAIL

TO: DIRECTOR, FBI
FROM: SAC, CLEVELAND [redacted]
RE: DR. FIDEL CASTRO
[redacted]

b3
b7E

Re Cleveland letter of 4-21-59, captioned as above.

Additional review of Cleveland Office files disclosed a matter entitled, [redacted], in which Washington Field is the office of origin and in which the Bufile is [redacted]

b3
b6
b7C
b7E

In the Washington Field case mention is made of the meeting between [redacted] at Toledo, Ohio, wherein [redacted] was offering eleven planes described as possibly being C-74s.

b6
b7C

Cleveland Office inquiry at Toledo, Ohio in March, 1959, in response to a Washington Field lead in the [redacted] matter developed information relative to [redacted]. It was learned that [redacted] was acting as a representative of the Akros Dynamics Corporation of Cleveland, owner of eleven Douglas C-74 type aircraft.

b6
b7C

The Akros Dynamics Corporation was said to be an investment firm located at 1810 Terminal Tower, Cleveland, and the principal officers of the firm are [redacted] all of Cleveland, Ohio. It was said that all of the planes were purchased from the government by this firm as an investment for lease or resale.

b6
b7C

It was said that the sale of the planes to the UAR did not go through because approval of the sale could not be obtained from the State Department.

3-Bureau
2-Cincinnati
2-Cleveland [redacted]

(7)

[redacted]	
SEARCHED [redacted]	INDEXED [redacted]
SERIALIZED [redacted]	FILED [redacted]
APR 30 1959	
[redacted]	

b3
b6
b7C
b7E

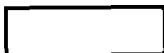

b3
b7E

The Cincinnati Office at Columbus, Ohio, is requested to make discreet inquiry at the office of the Ohio Secretary of State for complete information on the corporate origin and setup of the Akros Dynamics Corporation, 1810 Terminal Tower, Cleveland, Ohio, the partial officership of which is set out hereinbefore. It is believed this corporation was formed in early 1958.

The Cincinnati Office will advise the Bureau of the results of their inquiry under the caption of this letter and will also make the information available to the Cleveland Office.

Director, FBI

4-21-59

SAC, Cleveland

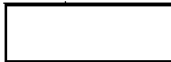

b3
b7E

DR. FIDEL CASTRO

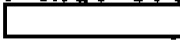

Prior to departing for Miami Beach, Florida, for a vacation of approximately one month in that city and subsequently in the Tampa, Fla. area,  on 4/15, 16/59, furnished the following information:

b7D



b6
b7C
b7D

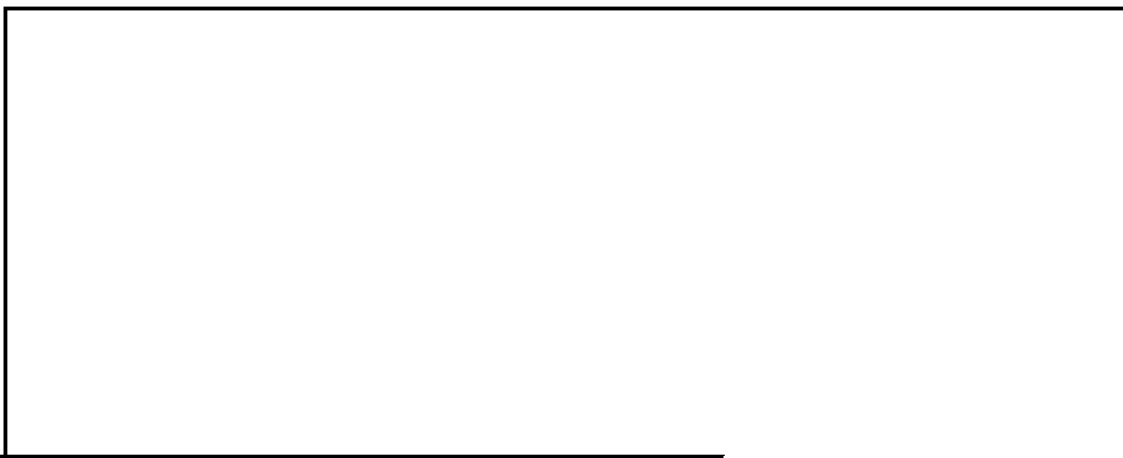

b6
b7C
b7D



2-Bureau
2-Cleveland

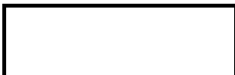

(4)

COPY



SERIALIZED	INDEXED
FILED	
APR 20 1959	

b3
b6
b7C
b7D
b7E

b3
b7E

[Redacted]

[Redacted]

b6
b7C
b7D

On 4-16-59, the informant said [Redacted]

[Redacted]

b6
b7C
b7D

[Redacted] He will furnish any subsequent information he obtains regarding this matter.

The informant confidentially advised that [Redacted]

[Redacted]

b6
b7C
b7D
b7E

[Redacted]

b6
b7C
b7D

[redacted]

b3
b7E

[redacted]

b6
b7C
b7D

[redacted]

No information identifiable with [redacted] was found in the Cleveland Office indices, but there is information in file [redacted]

[redacted] of Condonna Uranium Mines Limited. Shares in this company were sold by a director of the company to several Toledo citizens who suspected that the company might not be wholly legitimate. The matter was referred to the Bureau under date of 6-24-58, under caption, "[redacted]"

b6
b7C

[redacted]

The Cleveland Office indices make reference to one [redacted] described by informants as [redacted] According to informants, [redacted]

b6
b7C
b7D

[redacted]

Upon receipt of additional information relative to this matter from Confidential Informant [redacted] the Bureau will be immediately advised.

b7D

Date 4-29-59

SAC: WFO

Legal Attache: _____

Re:

b3
b6
b7C
b7E

The enclosed is for your information. If used in a future report conceal all sources, paraphrase contents.

Enclosed are corrected pages from report of SA _____ dated _____

For information.

For appropriate action.

Remarks:

SEARCHED INDEXED
SERIALIZED FILED

APR 30 1959

b3
b6
b7C
b7E

Enclosure(s)

April 30, 1959

CODE

RADIOGRAM

URGENT

TO SAC SAN JUAN

FROM DIRECTOR FBI [REDACTED]

FIDEL CASTRO, [REDACTED]

REURRAD APRIL TWO NINE

LAST CAPTIONED QUOTE [REDACTED]

UNQUOTE.

AUTHORITY GRANTED ORALLY FURNISH INFO [REDACTED]

[REDACTED]

SAN JUAN, WFO ADVISED BY MAIL.

① - WASHINGTON FIELD

b3
b7D
b7E

[REDACTED]

SEARCHED [] INDEXED []
SERIALIZED [] FILED []

APR 30 5 21 PM '59

[REDACTED]

[REDACTED]

[REDACTED]

b3
b6
b7C
b7E



~~CONFIDENTIAL~~
UNITED STATES DEPARTMENT OF JUSTICE

FEDERAL BUREAU OF INVESTIGATION

In Reply, Please Refer to
File No.

Newark, New Jersey
May 5, 1959

FIDEL CASTRO

On April 21, 1959, Major [redacted] New Jersey State Police, West Trenton, New Jersey, furnished the following information concerning Castro's visit to Princeton, New Jersey on April 20, 1959, and April 21, 1959.

b6
b7C

He advised that Castro, the Prime Minister of Cuba, arrived at Princeton Junction, New Jersey, at 6:52 p.m. on April 20, 1959 aboard a Pennsylvania Railroad train. He was greeted there by approximately 100 persons and was immediately taken to the home of his host, [redacted] a professor at Rutgers University who resides in Princeton, New Jersey. He remained at the residence of [redacted] until a few minutes before 8:00 p.m., at which time he and members of his party motored to the Woodrow Wilson School of Public and International Affairs at Princeton University, Princeton, New Jersey. Upon his arrival at the Woodrow Wilson School, he was greeted by a group of students estimated to number approximately 1,000, and when this crowd recognized Castro, they became very enthusiastic and unruly, and attempted to crowd around his official party.

b6
b7C

The students broke through police lines set up around the Castro party and it was extremely difficult for the members of the official party to gain admittance to the Woodrow Wilson School, and it was necessary for the State Police officers to physically restrain the crowd in order to allow the members of the official party to enter the building.

There were no incidents of any kind during this greeting, and it was characterized by Major [redacted] as a typical college greeting.

b3
b6
b7C
b7E

Castro addressed the group of approximately 200 persons, primarily students of the Woodrow Wilson School, for approximately two hours and during his address there were no incidents of any kind. Upon the completion of his address

SEARCHED _____ INDEXED _____
SERIALIZED _____ FILED _____
MAY 5 1959
FBI - NEWARK
[redacted]

~~CONFIDENTIAL~~

~~CONFIDENTIAL~~

FIDEL CASTRO

he was escorted out the rear entrance of the building; however, he insisted upon being returned to the front of the building in order that he might address a group of approximately 200 students who had remained at the front entrance, awaiting his exit from the building. Upon his insistence, he was returned to the front of the building, where he gave an impromptu speech for approximately ten minutes.

He was then escorted to the residence of Governor Meyner of New Jersey in Princeton, New Jersey, where he was entertained at an informal reception. At the Governor's residence, he met with United States Senator Joseph Clark of Pennsylvania and former United States Secretary of State Dean Acheson, as well as personnel of the faculty of Princeton University.

He departed from the Governor's residence at approximately midnight and immediately returned to the residence of his host, [redacted] where he remained for the night.

b6
b7c

On the morning of April 21, 1959, he gave a short informal talk to the students of the Lawrenceville Preparatory School, Lawrenceville, New Jersey, and upon departing from there, he journeyed directly to the Pennsylvania Railroad Station, Princeton Junction, New Jersey. He boarded a Pennsylvania Railroad train at 9:50 a.m. en route to New York City, and was scheduled to arrive there at 10:45 a.m.

Major [redacted] advised that during his entire visit to Princeton, New Jersey, there were no incidents of any kind.

b6
b7c

This document contains neither recommendations nor conclusions of any kind. It is the property of the Federal Bureau of Investigation, and is a loan to your agency; it and/or its contents are not to be distributed outside your agency.

~~CONFIDENTIAL~~

Office Memorandum • UNITED STATES GOVERNMENT

TO : DIRECTOR, FBI [redacted]

DATE: 5/5/59

FROM : SAC, NEWARK [redacted]

SUBJECT: FIDEL CASTRO
[redacted]

b3
b7E

Re Newark airtel to Bureau dated 4/24/59.

Enclosed herewith are five copies for the Bureau, and one copy for Washington Field, of a letterhead memorandum dated and captioned as above.

The attached letterhead memorandum is classified ~~confidential~~ [redacted]

b3
b7E

During CASTRO's visit to Princeton, New Jersey, Bureau agents maintained liaison with personnel of the New Jersey State Police, the Princeton, New Jersey Police Department, and the Lawrenceville Police Department, as well as security personnel of the U. S. State Department.

All information of value was furnished to the above listed departments and they in turn advised that they would furnish any information of interest to the Bureau. It is to be noted that at no time during CASTRO's visit to Princeton, New Jersey, did he or any member of his official party become involved in any incidents of any type. His visit to Princeton, New Jersey, was scheduled and his activities while in Princeton, New Jersey, were limited to this schedule.

One copy of this letterhead memorandum is being furnished to the Washington Field Office inasmuch as that office has a continuing interest in this matter.

There is no additional investigation to be conducted in the Newark Division in this matter. - RUC

b6
b7c

- 2 - Bureau (ENCLS.5) REG.MAIL
- 1 - WFO (ENCL.1) REG.MAIL
- 1 - Newark [redacted]

(4)

- 104

SEARCHED	INDEXED
SERIAL [redacted]	FILED [redacted]
MAY 5 1959	
[redacted]	[redacted]

~~CONFIDENTIAL~~

b6
b7C

~~CONFIDENTIAL~~

May 15, 1959

FIDEL CASTRO

On May 14, 1959, a confidential informant, who has furnished reliable information in the past, [redacted]

[Large redacted block]

b3
b6
b7C
b7E

This memorandum is loaned to you by the Federal Bureau of Investigation, and neither it nor its contents are to be distributed outside the agency to which loaned.

- 3 - Bureau [redacted]
 - ② - WFO [redacted]
 - (1 - [redacted])
- [redacted]
- (5)

b3
b6
b7C
b7E

20

Searched [redacted]

Serialized [redacted]

Indexed [redacted]

Filed [redacted]

b3
b6
b7C
b7E

~~CONFIDENTIAL~~

[redacted]

5/15/69

AIRTEL

TO: DIRECTOR, FBI [redacted]

b3
b7E

FROM: SAC, WFO [redacted]

FIDEL CASTRO
[redacted]

Attached for the Bureau are five copies of a letterhead memo dated and captioned as above. The information was furnished by [redacted]

b3
b7E

Attached memo was classified ~~confidential~~ [redacted]

[redacted] and the information could result in the identification of an informant of continuing value and jeopardize future effectiveness thereof.

3 - Bureau (Encls. 5)

② - WFO
[redacted]

b3
b6
b7C
b7E

(5)
[redacted]

AD

b3
b6
b7C
b7E

Searched
Serialized
Indexed
Filed

AIRTEL

[redacted]

[redacted]



DIRECTOR, FBI 

5-28-59

b3
b6
b7C
b7E



SAC, WFO 

FIDEL CASTRO



ReBuairtel to WFO dated 4-7-59.

A review of the file revealed that all pertinent information has been furnished the Bureau and interested offices. Since FIDEL CASTRO has returned to Cuba this file will be placed in a closed status.

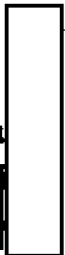
2 Bureau
1 WFO
(3)



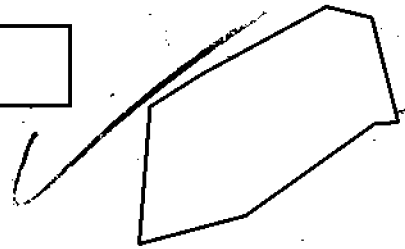



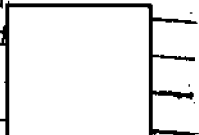

b3
b6
b7C
b7E

Searched
Serialized
Indexed



Post



C

SEARCHED	INDEXED
SERIALIZED	FILED

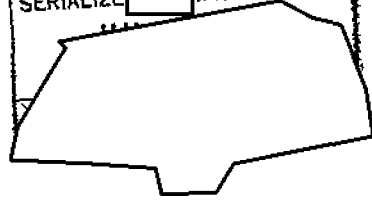

b3
b6
b7C
b7E

Date JUL 23 1959

TO SAC:

- Albany
- Albuquerque
- Anchorage
- Atlanta
- Baltimore
- Birmingham
- Boston
- Buffalo
- Butte
- Charlotte
- Chicago
- Cincinnati
- Cleveland
- Dallas
- Denver
- Detroit
- El Paso

- Honolulu
- Houston
- Indianapolis
- Jacksonville
- Kansas City
- Knoxville
- Little Rock
- Los Angeles
- Louisville
- Memphis
- Miami
- Milwaukee
- Minneapolis
- Mobile
- Newark
- New Haven

- New Orleans
- New York City
- Norfolk
- Oklahoma City
- Omaha
- Philadelphia
- Phoenix
- Pittsburgh
- Portland
- Richmond
- St. Louis
- Salt Lake City
- San Antonio
- San Diego
- San Francisco
- San Juan

- Savannah
- Seattle
- Springfield
- Washington Field
- Quantico

TO LEGAT:

- Bonn
- Havana
- London
- Madrid
- Mexico D. F.
- Ottawa
- Paris
- Rome
- Rio de Janeiro
- Tokyo

RE:

For information

For appropriate action

The enclosed is for your information. If used in a future report, conceal all sources, paraphrase contents.

Enclosed are corrected pages from report of SA _____ dated _____.

REMARKS:

Enclosure



SEARCHED		INDEXED	
SERIALIZED	[]	FILED	[]
JUL 24 1959			
[]			

b3
b6
b7C
b7E

~~CONFIDENTIAL~~

~~CONFIDENTIAL~~

b6
b7C

September 25, 1959

FIDEL CASTRO

The confidential informant mentioned in the letterhead memorandum dated and captioned as above has furnished reliable information in the past.

This memorandum contains neither recommendations nor conclusions of the Federal Bureau of Investigation. It is the property of the Federal Bureau of Investigation and is loaned to your agency; it and its contents are not to be distributed outside your agency.

- 4 - Bureau [redacted]
- ④ - WFO [redacted]
- [redacted]
- [redacted]
- (8) [redacted]

b3
b6
b7C
b7D
b7E

W

~~CONFIDENTIAL~~

~~CONFIDENTIAL~~

Searched	[redacted]
Serialized	[redacted]
Indexed	[redacted]
Filed	[redacted]

b3
b6
b7C
b7E

~~CONFIDENTIAL~~

September 23, 1950

FIDEL CASTRO

A confidential informant advised on September 24, 1950, that he learned that [redacted]

[redacted]

b6
b7C
b7D

On September 25, 1950, the informant advised that

[redacted]

The informant stated that

[redacted]

b6
b7C
b7D

The informant advised that

[redacted]

4 - Bureau [redacted]

④ - Washington Field [redacted]

[redacted]

b3
b6
b7C
b7D
b7E

[redacted]

(8)

[redacted]

W

[redacted]

Searched [redacted]
Serialized [redacted]
Indexed [redacted]
Filed [redacted]

~~CONFIDENTIAL~~

~~CONFIDENTIAL~~

Re: Fidel Castro

Concerning the Cuban situation, the informant
learned from

b6
b7C
b7D

Informant also learned

b6
b7C
b7D

This memorandum contains neither recommendations nor conclusions of the Federal Bureau of Investigation. It is the property of the Federal Bureau of Investigation and is a loan to your agency; it and its contents are not to be distributed outside your agency.

~~- 2 -~~

~~CONFIDENTIAL~~

C

9/25/59

AIRTEL

TO: DIRECTOR, FBI [redacted]

b3
b7E

FROM: SAC, WFO [redacted]

FIDEL CASTRO
[redacted]

Enclosed are four copies of a letterhead memo and an equal amount of letterhead memos evaluating the informant mentioned therein dated and captioned as above.

The information in enclosed letterhead memo was furnished by [redacted] to SA [redacted] on 9/24 and 25/59.

b6
b7C
b7D

The source advised on 9/25/59, that [redacted]

[redacted]

Source stated he will furnish this office all information he receives [redacted]

[redacted]

4 - Bureau (Encls. 4) sent 9/25/59.
2 - WFO

[redacted]

[redacted]
(8)

W

AIRTEL

Searched [redacted]
Serialized [redacted]
Indexed [redacted]
Filed [redacted]

[redacted]

b3
b6
b7C
b7D
b7E

b3
b6
b7C
b7E

ok
LO

[redacted]

The Bureau is aware that [redacted]
[redacted] who furnished reliable information [redacted]

[redacted]

The letterhead memos are classified "~~confidential~~"

[redacted]

[redacted]

and since the data reported could reasonably result in identification of a confidential informant of continuing value and compromise the future effectiveness thereof.

DIRECTOR, FBI [redacted]

10/12/59

b3
b6
b7C
b7E

SAC, WFO [redacted]

[redacted]

Re telephone call from Inspector [redacted]
of Bureau to WFO 10/1/59.

On 10/1/59, [redacted]

b6
b7C

[redacted] United Fruit Company, Room 605, 1511 K Street, N. W.,

WDC, was interviewed by SA [redacted] advised that his duties primarily involve liaison work with government officials in WDC. [redacted] advised that on 9/26/59, he was telephonically contacted by [redacted]

[redacted] an attorney having offices in the Cafritz Building.

[redacted] indicated that he would like to discuss a situation with [redacted] and would also like to bring an individual who [redacted] might be interested in. [redacted] stated that he had never heard of or seen [redacted] prior to this

contact. However, he agreed to see [redacted] on the afternoon of 9/26/59. [redacted] arrived in the office of [redacted] accompanied by subject. [redacted] stated that he

believed subject might have information of interest to [redacted]

After Subject, who described himself as an "international trouble shooter", informed [redacted] that he was a close personal friend of FIDEL CASTRO, present head of the Cuban Government. Subject also indicated that he was very well acquainted with all of the members of the current Cuban staff or Government. Subject stated that he was aware of the information which has been given considerable public press notice that there was a strong possibility that CASTRO would expropriate all of the land of the United Fruit Company in Cuba as well as any other private industry. Subject stated ~~he~~ believed that he could be of considerable help to the United Fruit Company to prevent this situation developing and that by just a few words to CASTRO and his assistants subject would be able to avoid such confiscation.

b6
b7C

b6
b7C

2-Bureau

②-WFO

[redacted] (CASTRO)

20

[redacted]

(4)

[redacted]

b3
b6
b7C
b7E

Searched [redacted]
Serialized [redacted]
Indexed [redacted]
Filed [redacted]

[redacted]

b3
b7E

Subject stated that he operated the concern known as Global Services which headquartered in Miami, Fla. He also stated that he had helped many U. S. concerns in connection with difficulties in various foreign countries. In this connection he stated that he had been most helpful to Pan American Airways in various countries served by this concern. [redacted] contact, according to subject, was [redacted]

b6
b7C

[redacted] of Pan American Airways.

Subject then asked [redacted] if he believed the United Fruit Company would be interested in utilizing his services.

[redacted] stated that he had no idea as to whether consideration would be given to this matter but that he would forward the information furnished by subject to the president of United Fruit Company in Boston, Mass., for any consideration he might desire to give it. [redacted] also informed the subject that if their concern should become interested in utilizing the services of subject he would be advised and could proceed to Boston, Mass., for interview with other company officials. Subject and [redacted] then departed and [redacted] has heard nothing further from them since the above date. [redacted] stated that at no time during the contact with subject was there any indication or inference that subject was employed or connected with the Cuban Government or any other foreign government as an agent.

b6
b7C

[redacted] advised that at the beginning of the interview with subject and [redacted] he informed them that he would accept any statements they desired to make but that no action would be taken personally by him and the matter merely furnished to his superiors. [redacted]

b3
b6
b7C
b7E

[redacted] was advised that the files of the FBI are confidential and that no information whatsoever re subject could be furnished to him. He stated that he was aware of this situation having had various contacts with the Bureau in the past, but that he believed

[redacted]

b3
b7E

the Bureau would be interested in the information furnished by subject and that in the event of any further contact he would again advise the WFO. [redacted] stated that he intends to make additional inquiries concerning the possible merit, as well as the background of subject. In this connection, a vice president of the United Fruit Company, who headquarters in NYC, has contacted [redacted] Pan American Airways who informed the United Fruit Company official that he was acquainted with subject and considered him a "remarkable man".

b6
b7C

As the Bureau is aware, WFO has maintained contact with [redacted] intermittently over the past 2 or 3 years re subject's activities. Efforts to establish a violation of the Registration Act have been unsuccessful. In the absence of additional information indicating a possible violation of the Registration Act or other matters coming within the Bureau's jurisdiction, no further action re this matter is contemplated at this time. However, in the event additional information is received from [redacted] or other sources, the Bureau will be immediately advised.

b6
b7C

b6
b7C

~~CONFIDENTIAL~~

[redacted]

b3
b7E

Date: December 8, 1959
To: Office of Security
Department of State
From: John Edgar Hoover, Director
Subject: [redacted]

~~Test stamp~~

b3
b7E

A source who is in a position to furnish reliable information advised [redacted]

[Large redacted block]

b6
b7C
b7D

The above is furnished for your information.

[Large redacted block]

b3
b6
b7C
b7E

SEARCHED	INDEXED
SERIALIZED	FILED
DEC 9 1959	

- ① - WFO
- 1 - New York
- 1 - Miami
- 1 - Legat, Havana

~~CONFIDENTIAL~~

[redacted]

~~CONFIDENTIAL~~

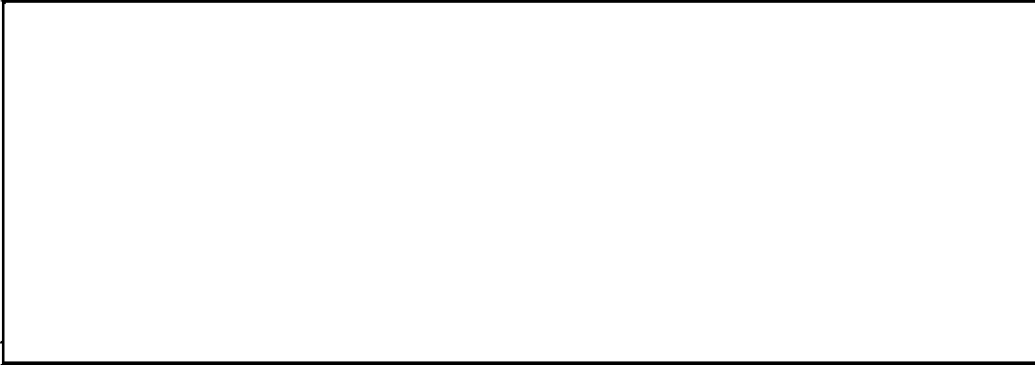

b3
b6
b7C
b7E

~~CONFIDENTIAL~~

January 11, 1960

AIRTEL

TO: SAC, MIAMI

FROM: DIRECTOR, FBI

FIDEL CASTRO

All offices receiving this communication should immediately advise the Bureau in the event any information is received indicating Castro plans to visit the United States.

- 1 - New York
- ① - WFO
- 1 - Havana
- 1 - Atlanta

b3
b7E

Handwritten scribble
1/15/60

SEARCHED
SERIALIZED

JAN 1 1960

b3
b6
b7C
b7E

UNITED STATES GOVERNMENT

Memorandum

TO : SAC, WFO

DATE: June 16, 1960

FROM : Director, FBI [redacted]

b3
b7E

SUBJECT: FIDEL CASTRO [redacted]

Pull

b6
b7C
b7E

On 6/3/60 [redacted]

(protect), [redacted]

[Large redacted block]

You should contact [redacted] and endeavor to verify the foregoing information. If the information is true, you should submit the information in letterhead memorandum form suitable for dissemination.

K

b6
b7C
b7D
b7E

On 6/10/60 [redacted] advised that [redacted] is the

[Redacted block]

In the event [redacted] contacts your office, you should accept any information he volunteers and furnish your observations and recommendations as to his potential as a PSI. No record of [redacted] was located in Bufiles.

b3
b6
b7C
b7E

Review & advise [redacted] 6/16/60 [redacted]

7

SEARCHED	INDEXED
SERIALIZED	FILED
JUN 17 1960	
F. B. I.	

DIRECTOR, FBI [redacted]

7/29/60

b3
b7E

SAC, WFO [redacted]

FIDEL CASTRO
[redacted]

ReBulet to WFO dated 6/16/60, captioned as above.

On 7/11 and 7/26/60, [redacted] was contacted by SA [redacted] concerning an indication that the informant

b6
b7C
b7D

[redacted]

For information of the Bureau, the informant advised that [redacted]

[redacted]

b7D

[redacted]

WEC
2-Bureau
2-WFO

[redacted]

[redacted]

(4)

REC
close

116

b3
b6
b7C
b7D
b7E

Searched _____
Serialized _____
[unclear] _____
[unclear] _____

8/19/60

PLAIN TEXT

AIRTEL

TO: DIRECTOR, FBI [redacted]
FROM: SAC, NEW YORK [redacted]
SUBJECT: FIDEL CASTRO RUZ
[redacted]

b3
b7E

Re Miami airtel, 8/2/60, requesting NYO to attempt to locate [redacted] and interview him concerning FIDEL CASTRO's physical condition.

b6
b7C

Miami PSI indicated [redacted] was known to the staff of the hospital, specializing in cancer, located on the east side of First Avenue, NYC. This is probably Memorial Center for Cancer and Allied Diseases, 444 East 68th Street.

On 8/18/60, [redacted] Memorial Center, advised that the Center includes Memorial Hospital, Sloan-Kettering Research Institute and James Ewing Institute. There is a total of 3,000 medical doctors and research scientists attached thereto.

b6
b7C

[redacted] caused a check of the records to be made and there was no record of [redacted]

[redacted] advised that one [redacted] a medical doctor formerly of Havana, Cuba, applied for a position with the Center, 8/17/60, and might be acquainted with [redacted]

b6
b7C

RUC.

- 3-Bureau [redacted] (RM)
- 2-Miami [redacted] (RM)
- ②-Washington Field (Info) (RM)
- 1-New York [redacted]

b3
b6
b7C
b7E

(3)

SEARCHED	INDEXED
SERIALIZED	FILED
AUG 22 1960	
FBI - WASH. F. O.	

Ⓟ

b3
b7E

[redacted]

[redacted] advised on 8/19/60, that she departed Havana 8/5/60, and flew directly to NYC. She said that [redacted] is a prominent general surgeon in Havana; however, she is not personally acquainted with him.

b6
b7C

[redacted] said that she had heard that [redacted] had left Cuba; however, she knows nothing about his present whereabouts. She said she would notify the NYC if she receives any information relative to [redacted] whereabouts.

b6
b7C

During the conversation with [redacted], it was pointed out that the press has carried several stories relative to CASTRO's health and her opinion was requested.

[redacted] said that she has no first hand knowledge about CASTRO's physical condition; however, there is much speculation in Cuban medical circles regarding his illness.

b6
b7C

[redacted] said she is of the opinion that CASTRO's recent illness was an attack of lobal pneumonia.

b6
b7C

The NYC contemplates no further active investigation to attempt to locate [redacted] unless Miami receives further information regarding his presence in NYC.

~~CONFIDENTIAL~~ b6
b7C

September 14, 1960

FIDEL CASTRO RUIZ
[redacted]

b3
b7E

On September 13, 1960, a confidential informant, who has furnished reliable information in the past, advised

[redacted]

b3
b6
b7C
b7E

On September 14, 1960, the same confidential informant learned from [redacted]

[redacted]

b3
b6
b7C
b7E

- 9- Bureau [redacted]
- 1- Miami [redacted]
- 1- Newark [redacted]
- 1- New York [redacted]
- ② WFO [redacted]

[redacted]

Searched [redacted]
Serialized [redacted]
Indexed [redacted]
Filed [redacted]

b3
b6
b7C
b7E

~~CONFIDENTIAL~~

9/14/60

AIRTEL

TO: DIRECTOR, FBI [redacted]
FROM: SAC, WFO [redacted]
SUBJECT: FIDEL CASTRO RUIZ
[redacted]

b3
b7E

Enclosed for the information of the Bureau are nine copies of a letterhead memorandum dated and captioned as above, reflecting information received from [redacted]. One each information copies are also designated for New York and Newark in view of CASTRO's projected visit to the New York area to attend the upcoming United Nations session. One information copy is also designated for Miami in view of their continuing interest in Cuban matters.

b3
b7E

In connection with [redacted] in the enclosed letterhead memorandum that [redacted]

[Large redacted block]

b3
b6
b7C
b7E

- 3- Bureau (Enc. 9)
- 1- Miami [redacted] (Enc. 1) (Info) (RM)
- 1- Newark [redacted] (Enc. 1) (Info) (RM)
- 1- New York [redacted] (Enc. 1) (Info) (RM)
- 2- WFO [redacted]

Info 9-14

b3
b6
b7C
b7E

(9)

[redacted]

Searched _____
Serialized _____
Indexed _____
Filed _____

b3
b6
b7C
b7E

[redacted]

b3
b7E

In the event the above information from [redacted] is disseminated in the future, it should be classified "~~Secret~~" due to the sensitive nature of the source. In the event of downgrading, it should be classified "~~Confidential~~" [redacted]

b3
b7E

[redacted] and the information could result in the identification of an informant of continuing value and compromise the future effectiveness thereof.

The attached letterhead memorandum is classified "~~Confidential~~" [redacted]

b3
b7E

[redacted] and the information could result in the identification of an informant of continuing value and compromise the future effectiveness thereof.

~~CONFIDENTIAL~~

September 15, 1960

FIDEL CASTRO RUEZ

[redacted]

b3
b7E

A confidential informant, who is in a position to have knowledge of [redacted]

[redacted] advised a Special Agent of the Federal Bureau of Investigation on September 15, 1960, that [redacted]

b7D

[redacted]

According to the informant, [redacted]

b7D

[redacted]

This document contains neither recommendations nor conclusions of the FBI. It is the property of the FBI and is loaned to your agency; it and its contents are not to be distributed outside your agency.

- 9-Bureau [redacted]
- 1-New York [redacted]
- 2-WFO [redacted]

[redacted]

(2)

b3
b6
b7C
b7D
b7E

[redacted]

[redacted]

b3
b6
b7C
b7E

SEARCHED [redacted]
SERIALIZED [redacted]
INDEXED [redacted]
FILED [redacted]

~~CONFIDENTIAL~~

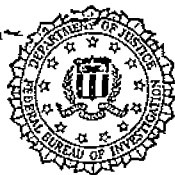

~~CONFIDENTIAL~~
UNITED STATES DEPARTMENT OF JUSTICE
FEDERAL BUREAU OF INVESTIGATION

In Reply, Please Refer to
File No.

Washington, D. C.
September 15, 1960

Title **FIDEL CASTRO RUIZ**

Character [redacted]

b3
b7E

Reference Memorandum dated and captioned as
above at Washington, D. C.

All sources (except any listed below) used in referenced
communication have furnished reliable information in the past.

The confidential informant mentioned has been
contacted an insufficient number of times to judge his
reliability, but is in a position to have accurate knowledge
of [redacted]

- 9-Bureau [redacted]
 - 1-New York [redacted]
 - (2-WFO [redacted])
 - [redacted]
 - [redacted]
- (12)

b3
b6
b7C
b7D
b7E



9/15/60

AIRTEL

TO: DIRECTOR, FBI [redacted]

b3
b7E

FROM: SAC, WFO [redacted]

FIDEL CASTRO RUIZ

[redacted]

There are being forwarded herewith for the Bureau and New York, copies of a letterhead memo and accompanying memo evaluating the source of the information set forth therein. The source furnishing the information was [redacted]. She furnished this information to SA [redacted].

b6
b7C
b7D

The attached letterhead memorandum and its accompanying memorandum evaluating source have been classified "Confidential" [redacted], and in addition the contents could possibly lead to disclosure of a potentially productive confidential informant.

b3
b7E

3-Bureau (Encls. 9)
1-New York [redacted] (Encl. 1) (Info) (RM)
2-WFO

b3
b6
b7C
b7D
b7E

[redacted]

[redacted]

(6)

AIRTEL

[redacted]

[redacted]
Searched [redacted]
Serialized [redacted]
Indexed [redacted]
Filed [redacted]

b3
b6
b7C
b7E

Per copies obtained by Special Messengers 9-15-60

[redacted]



UNITED STATES DEPARTMENT OF JUSTICE
FEDERAL BUREAU OF INVESTIGATION

~~CONFIDENTIAL~~

In Reply, Please Refer to
File No.

Washington 25, D. C.
September 15, 1960

FIDEL CASTRO RUZ
[redacted]

b3
b7E

A confidential informant who has furnished reliable information in the past, has advised that on September 14,

[redacted]

b3
b7E

Later on September 14, 1960, the same informant advised he had learned [redacted]

[redacted]

b3
b6
b7C
b7E

- 9 - Bureau [redacted]
- 1 - Miami [redacted] (Info) (RM)
- 1 - Newark [redacted] (Info) (RM)
- 1 - New York [redacted] (Info) (RM)
- 2 - WFO [redacted]
- (1) - [redacted]

[redacted]

Searched [redacted]
Serialized [redacted]
Indexed [redacted]
Filed [redacted]

b3
b6
b7C
b7E

(14) [redacted]

[redacted]

~~CONFIDENTIAL~~

~~CONFIDENTIAL~~

FIDEL CASTRO RUZ

[REDACTED]

b3
b6
b7C
b7E

The "Members of Permanent Missions To The United Nations Entitled To Diplomatic Privileges and Immunities" for July, 1960, reflects that Dr. Manuel Bisbe is Ambassador and Permanent Representative to the United Nations for Cuba.

The "Diplomatic List" for June, 1960, published by the USDS, reflects that [REDACTED] is

b6
b7C

This document contains neither recommendations nor conclusions of the FBI. It is the property of the FBI and is loaned to your agency; it and its contents are not to be distributed outside your agency.

~~CONFIDENTIAL~~

9/15/60

AIRTEL

TO: DIRECTOR, FBI [redacted]

FROM: SAC, WFO [redacted]

FIDEL CASTRO RUZ
[redacted]

b3
b7E

ReWFOairtel to Director, 9/14/60, captioned as above.

Enclosed for the Bureau are nine copies of a letterhead memo dated and captioned as above reflecting information received from [redacted]

b3
b7E

Information copies are also designated for New York and Newark in view of FIDEL CASTRO's possible attendance with other Cuban delegates at the forthcoming United Nations session at New York City.

An information copy is designated for Miami in view of their continuing interest in Cuban matters.

The attached letterhead memo is classified "~~Confidential~~" [redacted] and the information could result in identification of an informant of continuing value and compromise future effectiveness thereof.

b3
b7E

- 3- Bureau (Enc. 9)
- 1- Miami [redacted] (Enc. 1)(Info)(RM)
- 1- Newark [redacted] (Enc. 1)(Info)(RM)
- 1- New York [redacted] (Enc. 1)(Info)(RM)
- 2- WFO

b3
b6
b7C
b7E

[redacted]

(8)

AIRTEL

[redacted]

Searched _____

Serialized [redacted]

Indexed _____

Filed [redacted]

~~CONFIDENTIAL~~

b6
b7C

February 23, 1961

FIDEL CASTRO RUC

[redacted]

On February 22, 1961, an informant, who has furnished reliable information in the past, advised [redacted]

b3
b6
b7C
b7E

[redacted]

Prensa Latina is a Latin American News Service with headquarters in Havana, Cuba.

RUC

- 9 - Bureau [redacted]
- 1 - Miami [redacted] (Info) (RM)
- 1 - New York (Info) (RM)
- 2 - WFO [redacted]

b3
b6
b7C
b7E

[redacted]

(13)

[redacted]

[redacted]

[redacted]

Searched _____

Serialized _____

Indexed _____

Filed _____

b3
b6
b7C
b7E

This document contains neither recommendations nor conclusions of the FBI. It is the property of the FBI and is loaned to your agency; it and its contents are not to be distributed outside your agency.

~~CONFIDENTIAL~~

2/23/61

AIRTEL

TO: DIRECTOR, FBI [redacted]

b3
b7E

FROM: SAC, WFO [redacted]

FIDEL CASTRO RUZ

[redacted]

(OO:MM)

Enclosed herewith are nine copies to the Bureau, and one each to Miami and New York for information of a letterhead memo dated and captioned as above.

The informant referred to in the enclosed letterhead memo is [redacted]

b3
b7E

The enclosed letterhead memo is classified "~~Confidential~~" [redacted] and the information could result in the identification of an informant of continuing value and compromise the future effectiveness thereof.

RUC

- 3 - Bureau (Encs - 9)
- 1 - Miami [redacted] (Info) (RM) (Encs - 1)
- 1 - New York (Info) (RM) (Encs - 1)
- 2 - WFO

b3
b6
b7C
b7E

Handwritten: 2-23-61

[redacted]

[redacted]

[redacted]

Handwritten: f-4-11

AIRTEL

[redacted]	
Searched	[redacted]
Serialized	[redacted]
Indexed	[redacted]
Filed	[redacted]

b3
b6
b7C
b7E

UNITED STATES GOVERNMENT

Memorandum

TO : SAC, WFO [redacted]

DATE: APR 10 1961

b3
b6
b7C
b7E

FROM : SA [redacted]

SUBJECT: FIDEL CASTRO

[redacted]

On 3/29/61, [redacted]

[redacted] were interviewed at the above address. They furnished the names of the following individuals whom they felt were pro-CASTRO sympathizers residing in the Washington, D. C., area. Their reasons for naming these individuals were, according to them, because of statements made by these individuals in their presence or from conversations they had had with other Cubans in the Washington, D. C., area:

b6
b7C

[Large redacted area]

b6
b7C

⑥ - WFO

[redacted]

b3
b6
b7C
b7D
b7E

[redacted]

(6)

[redacted]

SEARCHED INDEXED
SERIALIZED FILED
APR 10 1961
FBI - WASH. F. O.

b3
b6
b7C
b7E

[REDACTED]

[REDACTED]

b3
b6
b7C
b7E

[REDACTED] advised he would be glad to furnish any information he had which could be of interest to the FBI. He also stated that he would attempt to obtain further identifying data of the above individuals and possibly information concerning their current activities and furnish same to WFO.

It is to be noted that [REDACTED] speaks only Spanish.

b6
b7C

F B I

Date: 12/2/63

C
MOB

Transmit the following in _____
(Type in plain text or code)

Via Airtel _____
(Priority or Method of Mailing)

To: SAC, WFO
2 - New York

From: Director, FBI [redacted]

FIDEL CASTRO
[redacted]

b3
b7E

ReWFOairtel 11/23/63 captioned "Assassination of President John F. Kennedy, 11/22/63. Assaulting Federal Officer," which set forth lead to interview [redacted] concerning statement allegedly made to him by [redacted]

b6
b7C

WFO and New York immediately advise results of interview of [redacted] and submit under this caption. If results already submitted under caption of referenced communication, furnish a copy of communication already sent to Bureau by return airtel under this caption.

[redacted]

b3
b6
b7C
b7E

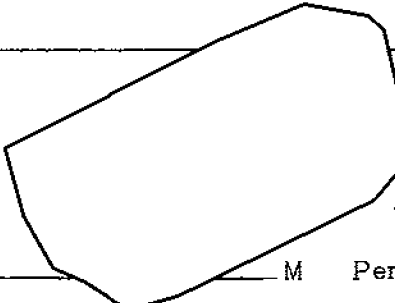

SEARCHED	[redacted]
SERIALIZED	[redacted]
DEC 3 1963	
FBI - WASH DC	
[redacted]	[redacted]

Sent Via _____ M Per _____

[redacted]

Office Memorandum • UNITED STATES GOVERNMENT

TO : SAC, WFO [REDACTED]

FROM : [REDACTED]

SUBJECT: FIDEL CASTRO
[REDACTED]

DATE: December 3, 1963

b3
b6
b7C
b7E

Today I called Supervisor [REDACTED] New York Office, concerning Bureau airtel dated 12/2/63 and captioned as above, and asked him to advise me as to the status of New York's inquiry into this matter.

[REDACTED] called back and advised that [REDACTED] has not been interviewed; that he is presently out of the country in Caracas, Venezuela, and is expected back sometime this week. The New York Office has advised the Bureau that [REDACTED] is out of the country and the lead is still outstanding.

b6
b7C

[REDACTED] called back again and advised that [REDACTED] had been located and interviewed on this date by the New York Office and that an appropriate communication setting forth the interview was being submitted.

1 - WFO

(1)

[REDACTED]
[REDACTED]
[REDACTED]
[REDACTED]

b3
b6
b7C
b7E



UNITED STATES DEPARTMENT OF JUSTICE

FEDERAL BUREAU OF INVESTIGATION

New York, New York
December 4, 1963

In Reply, Please Refer to
File No.

Re: Fidel Castro Ruz --

[redacted]

[redacted] Citizens Committee for a Free Cuba, 1426 G Street, Northwest, Washington, D. C., advised on November 23, 1963, that he was in contact [redacted] on November 22, 1963, with [redacted]

b3
b6
b7C
b7E

[redacted] stated that [redacted] informed him that [redacted]

[redacted] knows of a plan of Fidel Castro to kill United States Ambassadors in various countries. [redacted] stated that [redacted] received this information personally from [redacted] whom he had seen [redacted] stated that this information apparently had been received by [redacted] several months ago when he was [redacted] for some time.

[redacted] on December 3, 1963, advised that he had been to Washington, D. C. on November 22-23, 1963. [redacted] stated that on November 22, 1963, he had spoken with [redacted] an associate of [redacted] of the Citizens Committee for a Free Cuba. [redacted] stated that [redacted] is the [redacted] and in all probability told [redacted] about the details of his conversation of November 22, 1963.

b6
b7C

[redacted] advised that in June, 1962, he had made a trip to Chile in order to do a story on the Peace Corps and had then traveled to Peru on an assignment and then proceeded to Cali, Colombia, where he had an assignment to do photographic work for an international food exhibit. While in Cali, Colombia, [redacted] stated that he spoke with [redacted] in Cuba who had been very close to the government of Fidel Castro prior to his defection which took place in February, 1961. [redacted]

b6
b7C

This document contains neither recommendations nor conclusions of the FBI. It is the property of the FBI and is loaned to your agency; it and its contents are not to be distributed outside your agency.

[redacted]

[redacted]

SEARCHED [redacted] INDEXED [redacted]
SERIALIZED [redacted] FILED [redacted]

b3
b6
b7C
b7E

Re: Fidel Castro Ruz

advised that during one of his conversations with [redacted] [redacted] told him the following story:

b6
b7C

[redacted] stated that one day during the latter part of 1960, he had been to the Presidential Palace in Havana where he met a friend who had just come out of a meeting with Prime Minister Fidel Castro prior to assuming his post as Cuban Ambassador to [redacted] [redacted] said that he congratulated his friend whom he stated was a former student leader during the Cuban revolution, and his friend was very discouraged and downhearted as a result of his interview with Fidel Castro. [redacted]

b6
b7C

[redacted] stated that the new Cuban Ambassador to [redacted] left the office of Fidel Castro carrying a package and later after they had left the Presidential Palace, the new Cuban Ambassador showed [redacted] a machinegun which had been given to him by Fidel Castro, and was in the package which he carried out of the Prime Minister's office.

[redacted] stated that in conversation with the new Cuban Ambassador to [redacted] he, the new Ambassador, said that Fidel Castro told him of his plan to assassinate United States Ambassadors in 11 neutral countries in the event that the United States invaded Cuba. The new Cuban Ambassador told [redacted] that Fidel Castro was crazy, and that Castro was doing many things that he could not understand, and this was the reason why he was depressed and downhearted as a result of his interview with Castro. The new Cuban Ambassador to [redacted] told [redacted] that Castro had told him that he was selecting as Ambassadors to 11 neutral countries young revolutionaries who were dedicated to the ideals of the Cuban revolution, and that in the event the United States invaded Cuba, these 11 Cuban Ambassadors were to have a trusted staff member of the Cuban Embassy immediately seek out the United States Ambassador in that country and assassinate him.

b6
b7C

[redacted] stated that in his conversation with [redacted] he asked [redacted] whether or not he thought this story was true, and [redacted] said that from his past knowledge of, and association with, Fidel Castro, he had implicit trust in what the new Cuban Ambassador to [redacted] had told him, and he said that Castro was crazy enough to carry out such a plan.

b6
b7C

Re: Fidel Castro Ruz

[redacted] also advised on December 3, 1963, that at the time of his interview with [redacted] which took place in July, 1962, [redacted] had given him the name of the Cuban Ambassador to [redacted] but he did not recall his name exactly, but remembered it only as sounding like [redacted] (phonetic). [redacted] stated that this individual, [redacted] apparently had assumed his post as Ambassador to [redacted] during late 1960 or early 1961, and he was described by [redacted] as being a man in his middle thirties, who had been friendly with [redacted] [redacted] for many years in Cuba and particularly at the University of Havana.

b6
b7c

[redacted] stated that during his conversation with [redacted] relative to this plot of Castro to assassinate United States Ambassadors in the event of a United States invasion of Cuba, [redacted] said that there were no specific individuals mentioned, but the only specific statement made by the Cuban Ambassador to [redacted] was that Castro had indicated his plan as being directed against United States Ambassadors assigned to 11 neutral countries, without naming these neutral countries.

b6
b7c

[redacted] further stated on December 3, 1963, that while in Washington, D. C. during the period of November 22-23, 1963, he had prepared a memorandum in which he detailed his personal feelings about the possibility of the assassination of President John F. Kennedy being in some way caused by Cuban propaganda. [redacted] stated that his idea was to write a story for "Life" Magazine setting forth his thinking that the assassination of President John F. Kennedy could have been triggered by someone of the lunatic fringe who had been influenced by the constant Cuban propaganda directed against the United States and President John F. Kennedy by Prime Minister Fidel Castro. [redacted] stated that this theory was not accepted by his superiors, and in Washington, D. C. he noted that the American press was directing the opinion that the assassination of President John F. Kennedy had been brought about by someone connected with the extreme political right.

b6
b7c

Re: Fidel Castro Ruz

[redacted] also advised on December 3, 1963, that the only national magazine which has, in any way, indicated the possibility of Cuban involvement in the assassination of President John F. Kennedy was the current issue of "US News and World Report" dated December 9, 1963. This article appears on pages 90 and 91, and it is captioned, "What Are the Odds Against Castro Now". This article sets forth the thinking that Fidel Castro is everywhere stirring up trouble and violence and, specifically, states that pro-Castro terrorists are creating problems in Venezuela and other countries of this hemisphere.

b6
b7c



b6
b7C

12/4/63

AIRTEL REGISTERED MAIL

TO : DIRECTOR, FBI [redacted]

b3
b7E

FROM : SAC, NEW YORK [redacted]

SUBJECT: FIDEL CASTRO RUZ

[redacted]

ReBuairtel dated 12/2/63, entitled, "FIDEL CASTRO;
[redacted] and WFO airtel dated 11/23/63, entitled, "ASSASSINATION
OF PRESIDENT JOHN F. KENNEDY, 11/22/63; ASSAULTING FEDERAL
OFFICER".

b3
b7E

Enclosed herewith for the Bureau are 12 copies of a
letterhead memorandum setting forth results of interview with
[redacted] relative to information
furnished in re WFO airtel dated 11/23/63.

b6
b7C

There is also enclosed herewith for the information of
the Bureau one copy of [redacted]

b6
b7C
b7D

[Large redacted block]

There is also enclosed for the information of the
Bureau the article appearing in the 12/3/63 issue of "US News
and World Report" relative to the possible indirect connection
with the assassination of President JOHN F. KENNEDY.

4-Bureau [redacted] (Encls. 14) (RM)

(1 - [redacted])

2-WFO [redacted] (Encls. 2) (Info) (RM)

(1 - 89-75)

1-New York (89-75)

1-New York [redacted]

[redacted] (312)

(9)



SEARCHED [redacted]	INDEXED [redacted]
SERIALIZED [redacted]	FILED [redacted]
DEC 5 1963	

b3
b6
b7C
b7E

[redacted]

b3
b6
b7C
b7E

During interview with [redacted] he stated
that [redacted] had informed him that he had been interviewed
on numerous occasions [redacted]

[redacted]

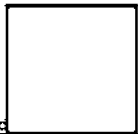

TO: SAC,

- Albany
- Albuquerque
- Anchorage
- Atlanta
- Baltimore
- Birmingham
- Boston
- Buffalo
- Butte
- Charlotte
- Chicago
- Cincinnati
- Cleveland
- Dallas
- Denver
- Detroit
- El Paso
- Honolulu

- Houston
- Indianapolis
- Jackson
- Jacksonville
- Kansas City
- Knoxville
- Las Vegas
- Little Rock
- Los Angeles
- Louisville
- Memphis
- Miami
- Milwaukee
- Minneapolis
- Mobile
- Newark
- New Haven
- New Orleans

- New York City
- Norfolk
- Oklahoma City
- Omaha
- Philadelphia
- Phoenix
- Pittsburgh
- Portland
- Richmond
- St. Louis
- Salt Lake City
- San Antonio
- San Diego
- San Francisco
- San Juan
- Savannah
- Seattle
- Springfield

- Tampa
- Washington Field
- Quantico

TO LEGAT:

- Bern
- Bonn
- London
- Manila
- Mexico, D.F.
- Ottawa
- Paris
- Rome
- Rio de Janeiro
- Tokyo

DEC 28 1964

Date _____

RE:

For information Retention optional For appropriate action Surep, by _____

The enclosed is for your information. If used in a future report, conceal all sources, paraphrase contents.

Enclosed are corrected pages from report of SA _____ dated _____

Remarks:

b3
b6
b7C
b7E

Enc.
Bufile
Urfile

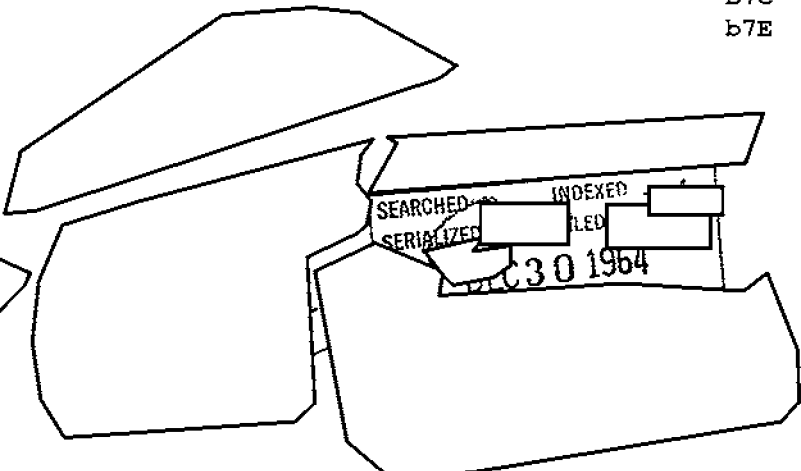

TO: SAC,

- Albany
- Albuquerque
- Anchorage
- Atlanta
- Baltimore
- Birmingham
- Boston
- Buffalo
- Butte
- Charlotte
- Chicago
- Cincinnati
- Cleveland
- Columbia
- Dallas
- Denver
- Detroit
- El Paso
- Honolulu

- Houston
- Indianapolis
- Jackson
- Jacksonville
- Kansas City
- Knoxville
- Las Vegas
- Little Rock
- Los Angeles
- Louisville
- Memphis
- Miami
- Milwaukee
- Minneapolis
- Mobile
- Newark
- New Haven
- New Orleans
- New York City

- Norfolk
- Oklahoma City
- Omaha
- Philadelphia
- Phoenix
- Pittsburgh
- Portland
- Richmond
- Sacramento
- St. Louis
- Salt Lake City
- San Antonio
- San Diego
- San Francisco
- San Juan
- Savannah
- Seattle
- Springfield

- Tampa
- Washington Field
- Quantico

TO LEGAT:

- Bern
- Bonn
- Buenos Aires
- Hong Kong
- London
- Manila
- Mexico, D.F.
- Ottawa
- Paris
- Rome
- Santo Domingo
- Tokyo

Date _____

FEB 16 1968

RE:

For information
 Retention optional
 For appropriate action
 Surep, by _____

The enclosed is for your information. If used in a future report, conceal all sources, paraphrase contents.

Enclosed are corrected pages from report of SA _____ dated _____

Remarks:

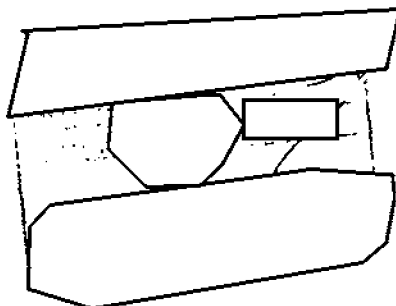

b3
b6
b7C
b7E

Enc.
Bufile
Urfile

TO: SAC,

- Albany
- Albuquerque
- Anchorage
- Atlanta
- Baltimore
- Birmingham
- Boston
- Buffalo
- Butte
- Charlotte
- Chicago
- Cincinnati
- Cleveland
- Columbia
- Dallas
- Denver
- Detroit
- El Paso
- Honolulu

- Houston
- Indianapolis
- Jackson
- Jacksonville
- Kansas City
- Knoxville
- Las Vegas
- Little Rock
- Los Angeles
- Louisville
- Memphis
- Miami
- Milwaukee
- Minneapolis
- Mobile
- Newark
- New Haven
- New Orleans

- New York City
- Norfolk
- Oklahoma City
- Omaha
- Philadelphia
- Phoenix
- Pittsburgh
- Portland
- Richmond
- St. Louis
- Salt Lake City
- San Antonio
- San Diego
- San Francisco
- San Juan
- Savannah
- Seattle
- Springfield

- Tampa
- Washington Field
- Quantico

TO LEGAT:

- Bern
- Bonn
- Buenos Aires
- Hong Kong
- London
- Manila
- Mexico, D.F.
- Ottawa
- Paris
- Rome
- Santo Domingo
- Tokyo

Date 4/3/68

RE:

For information Retention optional For appropriate action Surep, by _____

The enclosed is for your information. If used in a future report, conceal all sources, paraphrase contents.

Enclosed are corrected pages from report of SA _____ dated _____

Remarks:

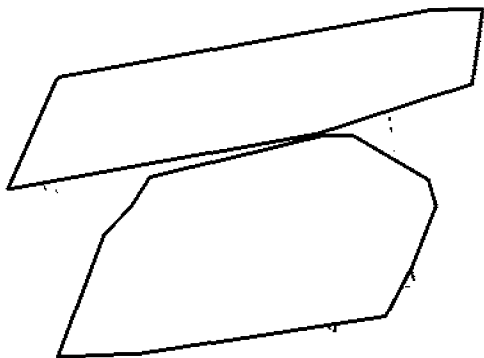

b3
b6
b7C
b7E

Enc.
Bufile
Urfile

TO: SAC,

- Albany
- Albuquerque
- Alexandria
- Anchorage
- Atlanta
- Baltimore
- Birmingham
- Boston
- Buffalo
- Butte
- Charlotte
- Chicago
- Cincinnati
- Cleveland
- Columbia
- Dallas
- Denver
- Detroit
- El Paso
- Honolulu

- Houston
- Indianapolis
- Jackson
- Jacksonville
- Kansas City
- Knoxville
- Las Vegas
- Little Rock
- Los Angeles
- Louisville
- Memphis
- Miami
- Milwaukee
- Minneapolis
- Mobile
- Newark
- New Haven
- New Orleans
- New York City

- Norfolk
- Oklahoma City
- Omaha
- Philadelphia
- Phoenix
- Pittsburgh
- Portland
- Richmond
- Sacramento
- St. Louis
- Salt Lake City
- San Antonio
- San Diego
- San Francisco
- San Juan
- Savannah
- Seattle
- Springfield

- Tampa
- ~~Washington Field~~
- Quantico

TO LEGAT:

- Bern
- Bonn
- Buenos Aires
- Hong Kong
- London
- Madrid
- Mexico, D.F.
- Ottawa
- Paris
- Rome
- Tokyo

Date DEC 2 1970

RE:

For information Retention optional For appropriate action Surep, by _____

The enclosed is for your information. If used in a future report,
 conceal all sources, paraphrase contents.

Enclosed are corrected pages from report of SA _____
dated _____.

Remarks:

b3
b6
b7C
b7E

Enc.
Bufile
Urfile

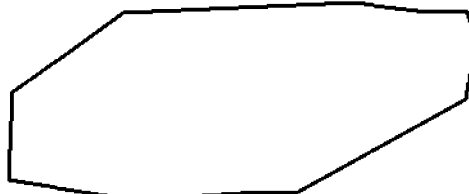

SEARCHED _____ INDEXED _____
SERIALIZED _____ FILED _____

DEC 3 1970



TO: SAC:

- Albany
- Albuquerque
- Alexandria
- Anchorage
- Atlanta
- Baltimore
- Birmingham
- Boston
- Buffalo
- Butte
- Charlotte
- Chicago
- Cincinnati
- Cleveland
- Columbia
- Dallas
- Denver
- Detroit
- El Paso
- Honolulu
- Houston
- Indianapolis
- Jackson
- Jacksonville
- Kansas City
- Knoxville
- Las Vegas
- Little Rock
- Los Angeles
- Louisville
- Memphis
- Miami
- Milwaukee
- Minneapolis
- Mobile
- Newark
- New Haven
- New Orleans
- New York City
- Norfolk

- Oklahoma City
- Omaha
- Philadelphia
- Phoenix
- Pittsburgh
- Portland
- Richmond
- Sacramento
- St. Louis
- Salt Lake City
- San Antonio
- San Diego
- San Francisco
- San Juan
- Savannah
- Seattle
- Springfield
- Tampa
- Washington Field
- Quantico

TO LEGAT:

- Beirut
- Bern
- Bonn
- Brasilia
- Buenos Aires
- Caracas
- Copenhagen
- Hong Kong
- La Paz
- London
- Madrid
- Managua
- Manila
- Mexico City
- Ottawa
- Paris
- Rome
- Singapore
- Tel Aviv
- Tokyo

RE:

Date OCT 30 1973



b3
b7E

- For information Retention optional For appropriate action Surep. by _____
- The enclosed is for your information. If used in a future report, conceal all sources, paraphrase contents.
- Enclosed are corrected pages from report of SA _____ dated _____

Remarks:

b3
b6
b7C
b7E

Enc.

Bufile
Urfile

SEARCHED INDEXED

SERIALIZED FILED

OCT 31 1973

FBI-WASHINGTON FIELD OFFICE

Routing Slip
0-7 (Rev. 12-17-73)

C
5
b

TO: SAC:

- Albany
- Albuquerque
- Alexandria
- Anchorage
- Atlanta
- Baltimore
- Birmingham
- Boston
- Buffalo
- Butte
- Charlotte
- Chicago
- Cincinnati
- Cleveland
- Columbia
- Dallas
- Denver
- Detroit
- El Paso
- Honolulu
- Houston
- Indianapolis
- Jackson
- Jacksonville
- Kansas City
- Knoxville
- Las Vegas
- Little Rock
- Los Angeles
- Louisville
- Memphis
- Miami
- Milwaukee
- Minneapolis
- Mobile
- Newark
- New Haven
- New Orleans
- New York City
- Norfolk

- Oklahoma City
- Omaha
- Philadelphia
- Phoenix
- Pittsburgh
- Portland
- Richmond
- Sacramento
- St. Louis
- Salt Lake City
- San Antonio
- San Diego
- San Francisco
- San Juan
- Savannah
- Seattle
- Springfield
- Tampa
- Washington Field
- Quantico

TO LEGAT:

- Beirut
- Bem
- Bonn
- Brasilia
- Buenos Aires
- Caracas
- Hong Kong
- London
- Madrid
- Manila
- Mexico City
- Ottawa
- Paris
- Rome
- Singapore
- Tel Aviv
- Tokyo

b3
b7E

RE: [Redacted] Date **February 24, 1975**

[Redacted]

- For information Retention optional For appropriate action Surep, by _____
- The enclosed is for your information. If used in a future report, conceal all sources, paraphrase contents.
- Enclosed are corrected pages from report of SA _____ dated _____

Remarks:

b3
b6
b7C
b7E

DECLASSIFICATION AUTHORITY DERIVED FROM:
FBI AUTOMATIC DECLASSIFICATION GUIDE
DATE 03-29-2023 BY: [Redacted]

[Redacted]

SEARCHED _____ INDEXED _____
SERIALIZED _____ FILED _____
FEB 25 1975
FBI - WASH. FIELD

Enc.
Bufile
Urfile

~~SECRET MATERIAL ATTACHED~~

(Copies to [redacted] es Checked)

NO FOREIGN DISSEMINATION

Routing Slip
0-7 (Rev. 12-17-73)

TO: SAC:

- Albany
- Albuquerque
- Alexandria
- Anchorage
- Atlanta
- Baltimore
- Birmingham
- Boston
- Buffalo
- Butte
- Charlotte
- Chicago
- Cincinnati
- Cleveland
- Columbia
- Dallas
- Denver
- Detroit
- El Paso
- Honolulu

- Houston
- Indianapolis
- Jackson
- Jacksonville
- Kansas City
- Knoxville
- Las Vegas
- Little Rock
- Los Angeles
- Louisville
- Memphis
- Miami
- Milwaukee
- Minneapolis
- Mobile
- Newark
- New Haven
- New Orleans
- New York City
- Norfolk

- Oklahoma City
- Omaha
- Philadelphia
- Phoenix
- Pittsburgh
- Portland
- Richmond
- Sacramento
- St. Louis
- Salt Lake City
- San Antonio
- San Diego
- San Francisco
- San Juan
- Savannah
- Seattle
- Springfield
- Tampa
- Washington Field
- Quantico

TO LEGAT:

- Beirut
- Bern
- Bonn
- Brasilia
- Buenos Aires
- Caracas
- Hong Kong
- London
- Madrid
- Manila
- Mexico City
- Ottawa
- Paris
- Rome
- Singapore
- Tel Aviv
- Tokyo

Search 5/2/75

RE:

Date April 18, 1975

[Redacted area]

- For information Retention optional For appropriate action Surep, by [redacted] b3
- The enclosed is for your information. If used in a future report, [redacted] conceal b7E
- Enclosed are corrected pages from report of SA [redacted] dated [redacted]

Remarks:

DECLASSIFICATION AUTHORITY DERIVED FROM:
FBI AUTOMATIC DECLASSIFICATION GUIDE
DATE 03-06-2023 BY: [redacted]

b3
b6
b7C
b7E

SEARCHED [redacted] INDEXED [redacted]
SERIALIZED [redacted] FILED [redacted]
APR 21 1975
FBI-WASH. FIELD OF [redacted]

Enc.
Bufile
Urfile

~~SECRET MATERIAL ATTACHED~~

To : Washington

Date 9/5/02

From : Newark

Subject:

(Title)

RUC
 File Destruction Program

b3
b7E

Enclosed are 3 items.

These items are forwarded to your office since file meets criteria for destruction.

Enclosures are described as follows:

- Original Notes.
- Original FD-302's.
- Laboratory and/or Technical Reports.
- Miscellaneous Documents.

Enc.

NOTE: DO NOT BLOCK STAMP ORIGINAL ENCLOSURES.

b3
b7E

FEDERAL BUREAU OF INVESTIGATION
FOI/PA
DELETED PAGE INFORMATION SHEET
FOI/PA# 1362425-000

Total Deleted Page(s) = 3
Page 5 ~ Duplicate;
Page 6 ~ Duplicate;
Page 8 ~ Duplicate;

XXXXXXXXXXXXXXXXXXXXXXXXXXXX
X Deleted Page(s) X
X No Duplication Fee X
X For this Page X
XXXXXXXXXXXXXXXXXXXXXXXXXXXX

VZCZCHQ0126

PP AFO

DE HQ 0126 2392305

ZNY CCCCC

P 272126Z AUG 81

FM DIRECTOR FBI

TO ALL FBI FIELD OFFICES PRIORITY

BT

~~CONFIDENTIAL~~

POSSIBLE VISIT OF CUBAN PRESIDENT FIDEL CASTRO TO NEW YORK CITY,
SEPTEMBER 4 THROUGH 6, 1981; PFO; OO: NEW YORK

ON AUGUST 20, 1981, [REDACTED]

[REDACTED] ADVISED FBIHQ THAT THEY HAD RECEIVED

b7E

INFORMATION [REDACTED]

THAT

PRESIDENT FIDEL CASTRO OF CUBA TENTATIVELY PLANS TO VISIT
NEW YORK CITY, SEPTEMBER 4 THROUGH 6, 1981, FOR THE TWENTIETH
ANNIVERSARY OF THE NON-ALIGNED MOVEMENT. THIS COINCIDES WITH
THE OPENING OF THE UNITED NATIONS GENERAL ASSEMBLY. DETAILS
OF HIS ITINERARY HAVE NOT YET BEEN RECEIVED. (X) (U)

IT IS REQUESTED THAT RECIPIENTS WITH APPROPRIATE SOURCES
CONTACT THEM TO DETERMINE IF PRESIDENT CASTRO'S POSSIBLE
VISIT TO THE UNITED STATES IS KNOWN BY ANTI-CASTRO OR OTHER

[Handwritten notes and signatures]
DAA
8/23/81

185-195-1
SEARCHED [] INDEXED []
SERIALIZED [] FILED []
[REDACTED]

b6
b7c

PAGE TWO DE HQ 0126 ~~C O N F I D E N T I A L~~

ELEMENTS WHO MIGHT PRESENT A THREAT TO HIS SECURITY. IF SO, DETERMINE THROUGH THESE SOURCES WHETHER OR NOT ANY INDIVIDUALS OR GROUPS HAVE TARGETED HIM FOR VIOLENCE DURING HIS VISIT. EXTREME CAUTION IS TO BE USED WHEN CONTACTING SOURCES TO INSURE THAT IF CASTRO'S POSSIBLE VISIT IS NOT YET KNOWN, THE ANTI-CASTRO COMMUNITY IS NOT MADE AWARE OF IT. OTHER OFFICES ARE REQUESTED TO IMMEDIATELY NOTIFY FBIHQ OF ANY INFORMATION RECEIVED PERTINENT TO THE POSSIBLE VISIT OF CASTRO TO THE UNITED STATES. ~~(S)~~ (U)

[REDACTED]

[REDACTED]

b7E

ALL INTERVIEWS, WHERE APPROPRIATE, WILL BE CONDUCTED JOINTLY BY FBI [REDACTED] POSITIVE INFORMATION ONLY IS TO BE FURNISHED. ~~(S)~~ (U)

~~C & E 8024, REASONS 2 & 3, DRD AUGUST 27, 2001.~~

BT

0126

NNNN

FBI

TRANSMIT VIA:

- Teletype
- Facsimile
- _____

PRECEDENCE:

- Immediate
- Priority
- Routine

CLASSIFICATION:

- TOP SECRET
- SECRET
- ~~CONFIDENTIAL~~
- UNCLAS E F T O
- UNCLAS

Date 9/4/81

012

FM BALTIMORE (185-195) (SQ. 3) -P-

TO DIRECTOR ROUTINE

356 [redacted]

NEW YORK ROUTINE

416 [redacted]

BT

~~CONFIDENTIAL~~

POSSIBLE VISIT OF CUBAN PRESIDENT FIDEL CASTRO TO NEW YORK CITY,
SEPTEMBER 4 THROUGH 6, 1981; PFO; OO: NEW YORK

RE BUREAU TELETYPE TO ALL OFFICES, AUGUST 27, 1981. (U)

APPROPRIATE SOURCES BALTIMORE CONTACTED AND COULD PROVIDE
NO INFORMATION RELEVANT TO CAPTIONED VISIT. BALTIMORE WILL REMAIN
ALERT FOR SOURCE INFORMATION OF VALUE AND IMMEDIATELY FURNISH SAME
TO APPROPRIATE OFFICES. ~~(S)~~ (U)

C AND E 3902, REASON (2&3), DRD SEPTEMBER 4, 2001.

BT

#

1 - [redacted]

[redacted]

[redacted]

SEARCHED.....
INDEXED.....
SERIALIZED.....
FILED.....

4 SEP 01 11 27 AM '81

185-195-2

Approved: EDH [redacted]

Transmitted

(Number)

012

(Time)

Per [redacted]

~~CONFIDENTIAL~~

b6
b7C

X AIRTEL

9/16/81

TO: DIRECTOR

FROM: SAC, BALTIMORE (185-195)(SQ 3)(RUC)

POSSIBLE VISIT OF CUBAN PRESIDENT
FIDEL CASTRO TO NEW YORK CITY,
SEPTEMBER 4, - 6, 1981
PFO
OO: NY

#6-6-81
10-6-81

b6
b7C

Re Baltimore teletype to Bureau, 9/4/81.

(U)

Canvas of appropriate sources in Baltimore,
failed to reveal any information regarding captioned
matter, and no further investigation being conducted
this office.

~~(S)~~

(U)

~~Classified and Extended by 3902
Reason for Extension FCIM, II, 1-2.4.2 (2 and 3)
Date of Review for Declassification September 16, 2001~~

- 2 - Bureau
- 2 - New York
- 2 - Baltimore (1 - [redacted])

[redacted] (6)
7/1

[redacted]

b6
b7C
b7D

Searched [redacted]
Serialized [redacted]
Indexed [redacted]
Filed [redacted]

b6
b7C

~~CONFIDENTIAL~~

185-195-3

VZCZGH00193
RP MM
DE HQ 0193 1550900
ZNY CCCCC
R 032110Z JUN 83
FM DIRECTOR FBI
TO FBI MIAMI ROUTINE
BT

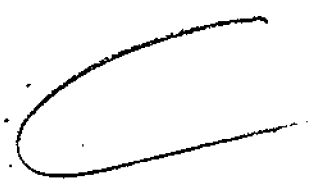

Unsub;

~~CONFIDENTIAL~~
Plot to

UNSUBSINGPLOD:MIAMIASSASSINATE FIDEL CASTRO; PFO - INFORMATION

ON JUNE 3, 1983, [redacted]

[redacted]

TELEPHONE NUMBER [redacted] TELEPHONICALLY ADVISED THAT ON
JUNE 2, 1983, [redacted] HAD RECEIVED

A TELEPHONE CALL FROM [redacted] A REPORTER FOR THE "MIAMI
HERALD" NEWSPAPER. [redacted] ALLEGEDLY WRITES NEWSPAPER ARTICLES

ON CUBAN EXILES IN THE MIAMI AREA AND ON THE CUBAN GROUPS
OMEGA 7 AND ALPHA 66. [redacted] ADVISED [redacted]

[redacted] THAT HE HAS KNOWLEDGE OF A CURRENT PLOT WITHIN THE
CUBAN EXILE COMMUNITY IN MIAMI TO ASSASSINATE FIDEL CASTRO.

[redacted] WANTED CORROBORATION OF HIS STORY AND ASKED QUESTIONS

b6
b7c
b7E

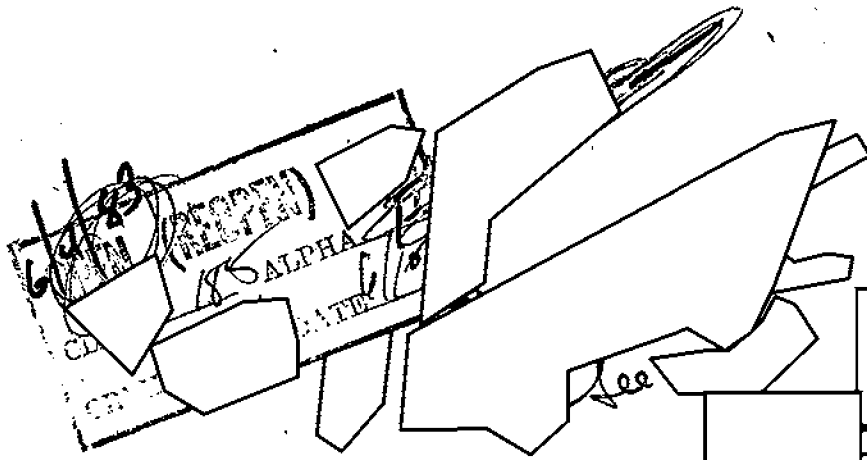

185A-169-1

[redacted]
[redacted]
[redacted]
[redacted]
[redacted]

b6
b7c

ABOUT A PREVIOUS PLOT TO ASSASSINATE CASTRO IN 1979. [REDACTED]
WAS NOT GIVEN ANY INFORMATION [REDACTED] BUT [REDACTED] DID
VERIFY THAT [REDACTED] WAS IN FACT A REPORTER FOR THE "MIAMI HERALD."

b6
b7C
b7E

[REDACTED]
[REDACTED] TO CONTACT [REDACTED] FOR FURTHER INFORMATION, AND WISHES
THE FBI TO ACCOMPANY THEM DURING THE INTERVIEW. THEY ANTICIPATE
CONTACTING THE FBI, MIAMI OFFICE ON MONDAY, JUNE 6, 1983.

MIAMI, [REDACTED] WILL ACCOMPANY THEM
DURING INTERVIEW OF REPORTER [REDACTED] AND ADVISE FBIHQ
OF RESULTS.

b6
b7C
b7E

~~C BY 8011, DECL: OADR~~

BT

0193

NNNN

MM 0925 1602245Z

PR 0

DE MM

R 0102245S JUN 83

FM MIAMI (185A-MFM) (C)

TO DIRECTOR ROUTINE

BT

~~CONFIDENTIAL~~

UNSUB; PLOT TO ASSASSINATE FIDEL CASTRO; PFO - INFORMATION.

RE BUREAU TELETYPE TO MIAMI DATED JUNE 3, 1983.

[redacted]

CONTACTED THIS DATE AND HE PROVIDED THE FOLLOWING INFORMATION:

HE TELEPHONED [redacted] ON JUNE 9, 1983, IN AN ATTEMPT TO
ARRANGE INTERVIEW WITH HIM IN CONNECTION WITH CAPTIONED MATTER.

[redacted] ACKNOWLEDGED DISCUSSING PLOT ON LIFE OF FIDEL CASTRO [redacted]

[redacted]

[redacted]

BUT DENIED THAT

CONVERSATION RELATED TO ANY CURRENT ASSASSINATION PLAN. HE TOLD

[redacted] THAT HE WAS MERELY TRYING TO CONFIRM AND EXPAND UPON INFOR-

MATION REGARDING AN ALLEGED ASSASSINATION PLOT ON PART OF CUBAN

EXILES DURING VISIT BY CASTRO TO UNITED STATES IN 1979. ALL INFOR-

Searched _____
Indexed _____
Serialized _____
Filed _____

[redacted]

b6
b7C
b7E

b6
b7C
b7E

b6
b7C

DATE 11/20/90 [redacted] /S/TTC

Extra copies purged and
destroyed pursuant to
instructions in BuA/T
11/3/86

185A-169-2

PAGE TWO MM (185-NEW) ~~CONFIDENTIAL~~

MATION THAT HE IS IN POSSESSION OF EMANATED FROM CUBAN EXILE SOURCES
IN MIAMI AND HE DEFINITELY HAS NO DATA CONCERNING A CURRENT PLAN TO
KILL CASTRO. [] DECLINED INTERVIEW []

[] AND STATED THAT HE AND HIS NEWSPAPER, THE MIAMI HERALD, WERE
NOT IN THE BUSINESS OF GETTING INFORMATION ON ANY INTERNATIONAL
PLOTS.

MIAMI, ACCORDINGLY, CONDUCTING NO FURTHER INVESTIGATION.

~~C BY G-3; DECL: OADP.~~

BT

b6
b7C
b7E

FEDERAL BUREAU OF INVESTIGATION
FOI/PA
DELETED PAGE INFORMATION SHEET
FOI/PA# 1362425-000

Total Deleted Page(s) = 9

- Page 6 ~ Duplicate;
- Page 7 ~ Duplicate;
- Page 13 ~ Duplicate;
- Page 14 ~ Duplicate;
- Page 15 ~ Duplicate;
- Page 16 ~ Duplicate;
- Page 20 ~ Duplicate;
- Page 21 ~ Duplicate;
- Page 22 ~ Duplicate;

```
XXXXXXXXXXXXXXXXXXXXXXXXXXXXX  
X Deleted Page(s) X  
X No Duplication Fee X  
X For this Page X  
XXXXXXXXXXXXXXXXXXXXXXXXXXXXX
```

BU0017 2402104Z

RR HQ NY



RECEIVED
TELETYPE UNIT

Exec AD-Adm	
Exec AD-Inv	
Exec AD-LES	
Asst. Dir.:	
Adm. Serv.	
Crim. Inv.	
Ident.	
Inspection	
Intell.	
Laboratory	
Legal Coun.	
Rec. Mgmt.	
Tech. Serv.	
Training	
Off. of Cong. & Public Affs.	b6
Telephone Rm.	b7C
Director's Sec'y	

DE BU

R 282104Z AUG 81

FX BUFFALO (185-30) (RUC)

TO DIRECTOR ROUTINE

NEW YORK ROUTINE

BT

~~CONFIDENTIAL~~

POSSIBLE VISIT OF CUBAN PRESIDENT FIDEL CASTRO TO NEW YORK

CITY, SEPT. 4 - 6, 1981; PFO; OO: NEW YORK.

RE BUREAU TELETYPE, AUG. 27, 1981.

THIS ENTIRE COMMUNICATION IS CLASSIFIED ~~CONFIDENTIAL~~.

ON AUGUST 14, 1981, LIMITED CIVIL RIGHTS INVESTIGATION INITIATED BASED ON A CIVIL RIGHTS COMPLAINT FROM VICTIM, [redacted]

[redacted] TELEPHONE [redacted]

VICTIM INTERVIEWED ON AUGUST 20, 1981 AND ADVISED ON AUGUST 13,

1981 [redacted] HAD AN ARGUMENT IN

WHICH [redacted] STATED HE DID NOT LIKE PRESIDENT REAGAN. [redacted]

[redacted] THEN CALLED U.S. SECRET SERVICE, IN ANGER, REGARDING THEIR

185-1563

10 SEP 2 1981



on 3/0 to
8/31/81

ARGUMENT. VICTIM WAS INTERVIEWED THAT DAY BY TWO UNITED STATES
SECRET SERVICE AGENTS. ON AUGUST 20, 1981, VICTIM WAS INTER-
VIEWED BY FBI AND HE ADVISED THAT DURING THE INTERVIEW WITH
THE SECRET SERVICE MEN, HE WAS SLAPPED AND PUSHED AROUND.
VICTIM, WHO WAS INTERVIEWED IN FRONT OF HIS ATTORNEY, ADMITTED
TO FBI AGENTS HE WAS NOT PHYSICALLY ABUSED, BUT CLAIMED HE WAS
MENTALLY ABUSED. VICTIM ALSO ADMITTED DISLIKE FOR PRESIDENT
REAGAN. DURING INTERVIEW, [REDACTED] STATED TO FBI THAT IF
FIDEL CASTRO EVER CAME TO ROCHESTER, NEW YORK, HE WOULD "BLOW
HIS HEAD OFF". VICTIM ALSO ADMITTED TO BEING MENTALLY DISABLED.

b6
b7c

[REDACTED] WAS DESCRIBED AS WHITE MALE, BORN [REDACTED]

[REDACTED] HE SAID [REDACTED] AND LIVED AT

[REDACTED] BEFORE COMING TO

[REDACTED], BORN [REDACTED] ALSO WAS

INTERVIEWED. HE STATED [REDACTED] IS A VERY NERVOUS PERSON
WHO SPEAKS VERY VIOLENTLY BUT HE IS NOT A VIOLENT ACTING PER-
SON. CIVIL RIGHTS CASE CAPTIONED [REDACTED]

b6
b7c

[REDACTED] - VICTIM", CLOSED BY REPORT AT BUFFALO DATED AUGUST 14, 1981.

PAGE THREE BU 185-30 ROUTINE

ON AUGUST 28, 1981, INFORMATION CONCERNING STATEMENT MADE
BY [] ON AUGUST 20, 1981 TO BUAGENT RE CASTRO FURNISHED []
[] BUFFALO, NEW YORK.

NO FURTHER ACTION BEING ATAKEN AT THIS TIME BY BUFFALO.

~~C & E 6166. REASONS 2 & 3 DRD AUGUST 28, 2001.~~

BT

b6
b7C
b7E

~~CONFIDENTIAL~~

NOTE: ATTACHED ADVISES OF POSSIBLE VISIT OF THE UNITED STATES
BY CUBAN PRESIDENT FIDEL CASTRO AND INSTRUCTS ALL FBI
FIELD OFFICES TO CONTACT LOGICAL SOURCES TO DETERMINE THE POTENTIAL
FOR VIOLENCE WHICH COULD BE DIRECTED AGAINST PRESIDENT CASTRO DURING
HIS VISIT. ~~(S)~~ (U)

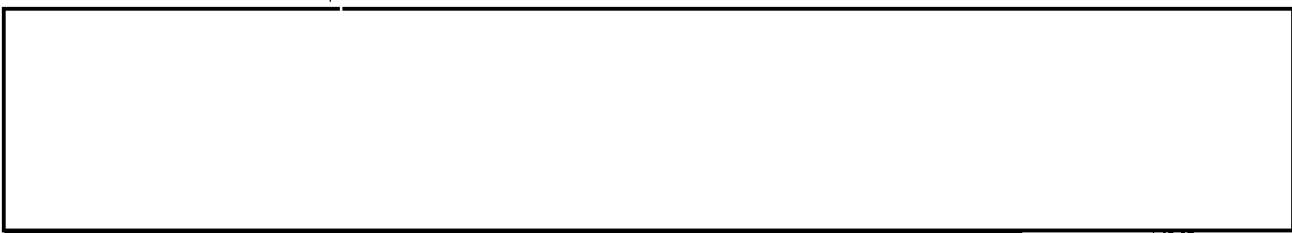

b7E



~~(S)~~ (U)

SEARCHED _____
SERIALIZED _____
INDEXED _____
FILED _____
MAR 24 1964
FBI - MEMPHIS

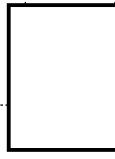

b6
b7C

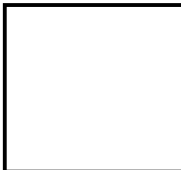

~~CONFIDENTIAL~~

b6
b7C

CG0010 2382208

RR HQ

DE CG

R 262208Z AUG 81

FM CHICAGO (185-NEW) (SQUAD 13)

TO DIRECTOR ROUTINE

MIAMI ROUTINE

NEWARK ROUTINE

NEW YORK ROUTINE

BT

[redacted] RECEIVED
ELETYPE UNIT

26 AUG 81 22 30

RECEIVED
FEDERAL BUREAU
OF INVESTIGATION
COMMUNICATIONS SECTION

Exec AD-Adm.	
Exec AD-Inv.	
Exec AD-LES	
Asst. Dir.:	
Adm. Serv.	
Crim. Inv.	
Ident.	
Inspection	
Intell.	
Laboratory	
Legal Coun.	
Rec. Mgmt.	
Tech. Serv.	
Training	
Off. of Cong. & Public Affs.	
Telephone Rm.	
Director's Sec'y	

~~CONFIDENTIAL~~

VISIT OF FIDEL CASTRO TO U.S.: PROTECTION OF FOREIGN OFFICIALS.

THIS COMMUNICATION IS CLASSIFIED ~~CONFIDENTIAL~~ IN ITS ENTIRETY.

ON INSTANT DATE, [redacted]

[redacted] ADVISED OF UPCOMING VISIT OF FIDEL

CASTRO TO THE U.S. ON SEPTEMBER 4, 1981.

REQUEST CONSISTED OF IDENTIFICATION OF GROUPS OR INDIVIDUALS THAT MIGHT POSE A THREAT TO CASTRO.

NO INDIVIDUALS WERE IDENTIFIED IN THE CHICAGO AREA,

185-1563-2

[redacted]

[redacted]

23 AUG 28 1981

b6
b7C

b6
b7C
b7E

b6
b7C

PAGE TWO CG 185-NEW ~~CONFIDENTIAL~~

BUT NAMES OF ANTI-CASTRO GROUPS THAT HAVE COME TO THE ATTENTION OF CHICAGO WERE PROVIDED. THESE GROUPS INCLUDE: ALPHA 66, OMEGA 7, JUNTA PATRIOTICA CUBANA (JPC), CUBAN NATIONALIST MOVEMENT (CNM), AND CUBA INDEPENDENTE Y DEMOCRATICA (CID).

THE BUREAU IS REQUESTED TO ADVISE IF CASTRO VISITING CHICAGO OR IF ANY INFORMATION IS AVAILABLE REGARDING PLANNED ANTI-CASTRO ACTIVITIES. CHICAGO WILL CONTACT IN EFFORT TO DEVELOP ADDITIONAL INFORMATION.

~~C AND E 7496, REASON 2 AND 3, DRD AUGUST 26, 2001.~~

BT

b7E



MESSAGE RELAY VIA TELETYPE

019

DATE 8/31	CLASSIFICATION CONF.	PRECEDENCE Routine
--------------	------------------------------------	-----------------------

FM DIRECTOR FBI

TO [redacted]
[redacted]

FEDERAL GOVERNMENT 22

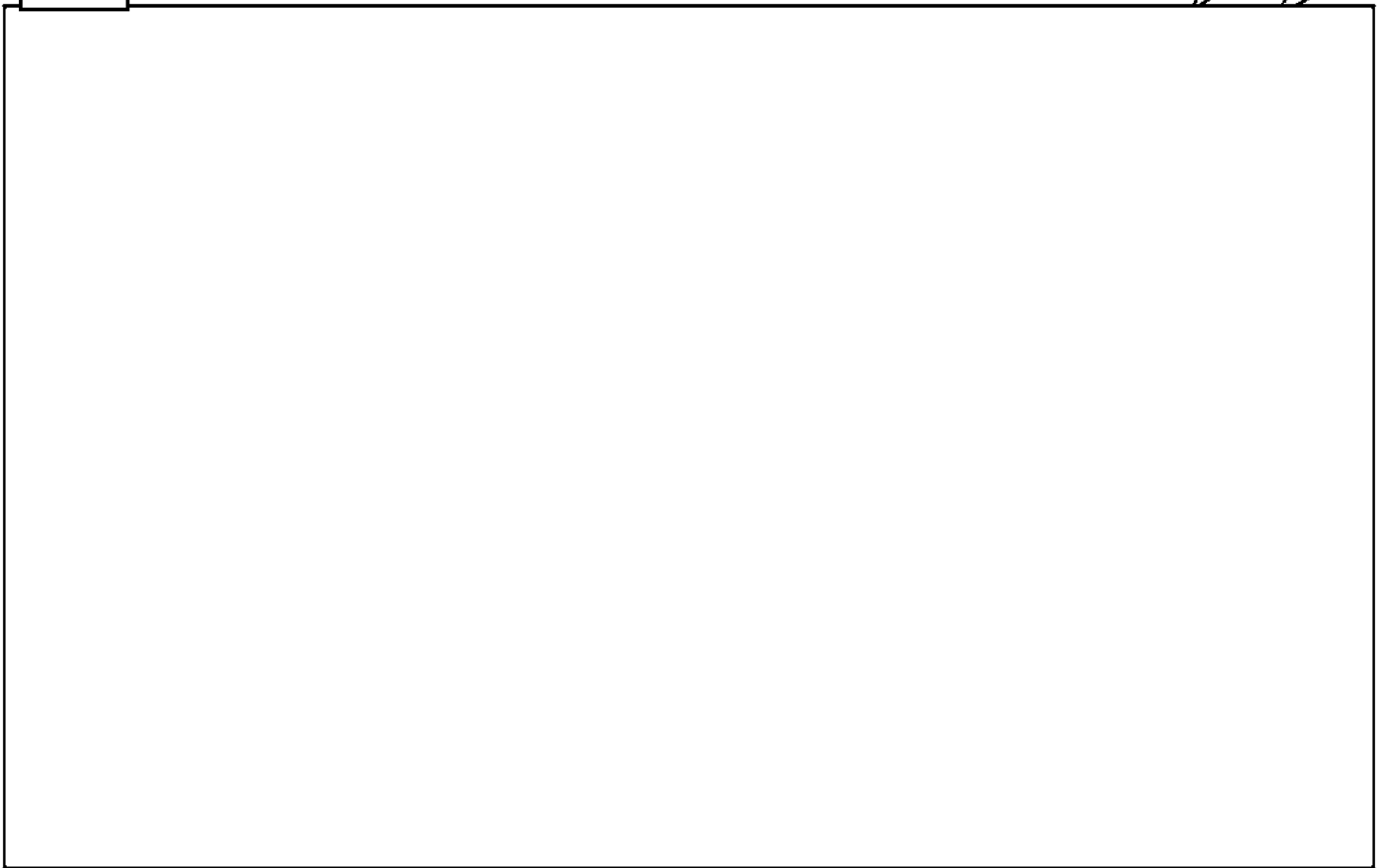

b3
b6
b7c
b7E

SUBJECT:

see attached
V-3 DE-72

APPROVE CM	[redacted]	ROOM 4084	TELE EXT. 4650
---------------	------------	--------------	-------------------

185-15633

FEDERAL BUREAU OF INVESTIGATION
COMMUNICATIONS CENTER
1815201
AUG 31 1981

SEP 1 1981

b6
b7c

39 SEP 24 1981 DO NOT FILE WITHOUT COMMUNICATIONS STAMP

059.148



b6
b7c

USE OF FORM 0-73

1. Only incoming teletype messages which require transmission relay may be prepared for transmission using form 0-73. Use of form 0-73 is restricted to incoming teletype messages received within the last 3 days which require transmission relay; all other teletype messages must be prepared using form 0-93.
2. Additions such as notes and administrative data for a specific addressee are not allowed. If a note or administrative data is required for a particular addressee a separate 0-73 form must be prepared.
3. The message will be transmitted just as it appears. The person approving the message is solely responsible for assuring all necessary editing changes have been made.

PREPARATION OF FORM WHICH CONSISTS OF A PREPRINTED YELLOW.

1. Complete appropriate boxes: date, classification & precedence.
2. List addresses immediately following the "TO" or place a check mark in the appropriate boxes.
3. Type or PRINT the subject in the space provided.
4. Print or type originator's name, room number and telephone extension.
5. Indicate approval for transmission by initialing the "Approved By" box.

RECEIVED
 TELETYPE SECTION
 31 AUG 86 15 09 Z
 FEDERAL BUREAU OF INVESTIGATION
 COMMUNICATIONS SECTION

PREPARATION OF MESSAGE TO BE TRANSMITTED

1. Xerox 1 copy of incoming teletype message. A notation shall be made on the original incoming teletype "1 copy made for relay to SACS _____, (OR LEGATS) _____, (OR GOVERNMENT AGENCIES) _____."
2. Minor editing changes shall be made on the xerox as follows: using a lead pencil ONLY draw single line through the first and last lines of the heading and connect these lines from top right to bottom left forming a "Z," figure. (DO NOT OBLITERATE THE HEADING.) Use horizontal lines to delete sentences or words. Printed changes of a word or two to the text of the message may be made; however, changes to the existing text involving more than a word or two necessitate the originator to initiate a new message using form 0-93.
3. Administrative data or notes may be typed immediately following the text and will be transmitted to all addressees.
4. When using the 0-73 form to disseminate information to field offices, Legal Attaches and other Government agencies simultaneously, the text, notes and administrative data must be identical for all addressees.

NK0008 2522051

RR HI NY

DE NK

R 092051Z SEP 81

FM NEWARK (185-147) (RUC) (FCI-1)

TO DIRECTOR (ROUTINE)

NEW YORK (ROUTINE)

BT

UNCLAS E F T O

POSSIBLE VISIT OF CUBAN PRESIDENT FIDEL CASTRO TO NEW YORK CITY

SEPTEMBER 4-6, 1981; PFO; OO: NEW YORK

Cuba

RE BUTEL AUGUST 27, 1981, AND SAN JUAN TEL SEPTEMBER 2, 1981.

THIS MATTER IS BEING RUC'D IN THAT CAPTIONED VISIT DID NOT OCCUR.

BT

RECEIVED
TELETYPE UNIT

9 00 01 20 37 Z

RECEIVED
FEDERAL BUREAU
OF INVESTIGATION
COMMUNICATIONS SECTION

Exec. AD	
Exec. AD	
Exec. AD	
Asst. Dir.:	
Adm. Serv.	
Crim. Inv.	
Ident.	
Inspect.	
Intell.	
Laboratory	
Legal Coun.	
Rec. Mgmt.	
Tech. Serv.	
Training	
Off. of Cong. & Public Affs.	
Telephone Rm.	
Director's Sec'y	

b6
b7C

[Redacted]

[Redacted]

[Redacted]

[Redacted]

185-1563-5

SEP 13 1981

b6
b7C

b6
b7C

66 SEP

[Redacted]

[Redacted]

25 2522055Z HQ 1

[Redacted]

FBI

TRANSMIT VIA:

- Teletype
- Facsimile
- AIRTEL

PRECEDENCE:

- Immediate
- Priority
- Routine

CLASSIFICATION:

- TOP SECRET
- SECRET
- CONFIDENTIAL
- UNCLAS E F T O
- UNCLAS

Date 9/8/81

~~CONFIDENTIAL~~

TO: DIRECTOR, FBI
 FROM: SAC, CLEVELAND (195-111) (RUC)

RE: POSSIBLE VISIT OF CUBAN PRESIDENT
 FIDEL CASTRO TO NEW YORK CITY,
 9/4-6/81;
 PFO

b6
b7C

OO: NEW YORK

Re Bureau teletype dated 8/27/81. (U)

Contact with appropriate sources regarding captioned matter was negative. (U)

Sources advised they were not aware of any contemplated visits now or in the future of captioned individual. (U)

b6
b7C

~~CONFIDENTIAL~~

CLASSIFIED AND EXTENDED BY 8618
 REASON FOR EXTENSION FCIM, II, 1-2, 4, 2, (2) (3)
 DATE OF REVIEW FOR DECLASSIFICATION 9/8/2001

185-1563-6

9 SEP 15 1981

b6
b7C

- ② - Bureau (RM)
 - 1 - New York (RM)
 - 1 - Cleveland
- [redacted]
(4)

[redacted]

b6
b7C

59 SEP 1981

[redacted]

Transmitted _____ (Number) _____ (Time)

Per _____

RECEIVED
TELETYPE UNIT

b6
b7C

H00011 2550125Z

RR HQ

DE HQ

R 11 2200Z SEP 81

FM HOUSTON (185-83) (RUC)

TO DIRECTOR ROUTINE

BT [redacted]

[redacted]

SEP 81 01 34z
RECEIVED
FEDERAL BUREAU
OF INVESTIGATION
COMMUNICATIONS SECTION

Exec. AD-Adm.	_____
Exec. AD-Inv.	_____
Exec. AD-LES	_____
Asst. Dir.:	
Adm. Serv.	_____
Crim. Inv.	_____
Ident.	_____
Inspection	_____
Intell.	_____
Laboratory	_____
Legal Coun.	_____
Plan. & Insp.	_____
Rec. Mgmt.	_____
Tech. Serv.	_____
Training	_____
Off. Cong. & Public Affs.	_____
Telephone Rm.	_____
Director's Sec'y	_____

b6
b7C

~~CONFIDENTIAL~~

POSSIBLE VISIT OF CUBAN PRESIDENT FIDEL CASTRO TO NEW YORK CITY,
SEPTEMBER 4 THROUGH 6, 1981; PFO. OO: NEW YORK.

HOUSTON DIVISION IN POSSESSION OF NO POSITIVE INFORMATION
PERTAINING TO CAPTIONED ACTIVITY.

C & E 220, REASONS 2 & 3, DRD SEPTEMBER 11, 2001.

BT

b6
b7C

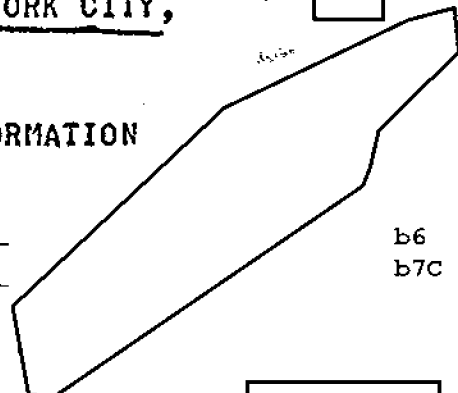

185-1563-7

SEP 16 1981

b6
b7C

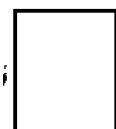

10

FBI

~~CONFIDENTIAL~~

TRANSMIT VIA:

- Teletype
- Facsimile
- Airtel

PRECEDENCE:

- Immediate
- Priority
- Routine

CLASSIFICATION:

- TOP SECRET
- SECRET
- CONFIDENTIAL
- UNCLAS E F T O
- UNCLAS

Date 9/17/81

TO: DIRECTOR, FBI

FROM: SAC, ALEXANDRIA (185-110) (RUC)

POSSIBLE VISIT OF CUBAN
PRESIDENT FIDEL CASTRO
TO NEW YORK CITY,
9/4-6/81

PFO
(OO:NEW YORK)

Inasmuch as no positive information has been developed concerning captioned matter in the Alexandria Division, and the date of the possible visit by Castro is past, this matter is being RUC'd by Alexandria. (c) (U)

~~CLASSIFIED AND EXTENDED BY 10010
IN FOR EXTENSION FCIM, II, 1-2.4.2 (2, 3)
DATE OF REVIEW FOR DECLASSIFICATION 9/17/2001~~

②-Bureau
2-New York
1-Alexandria

(5)

185-1563-10

16 SEP 21 1981

Approved: LKY

Transmitted _____ (Number) _____ (Time)

81

b6
b7C

b6
b7C

b6
b7C

b6
b7C

FBI

TRANSMIT VIA:

- Teletype
- Facsimile
- Airtel

PRECEDENCE:

- Immediate
- Priority
- Routine

CLASSIFICATION:

- TOP SECRET
- SECRET
- CONFIDENTIAL
- UNCLAS E F T O
- UNCLAS

Date 9/28/81

b6
b7C

TO: DIRECTOR, FBI

FROM: SAC, ATLANTA (185-64) (RUC) (Sq. 3)

POSSIBLE VISIT OF CUBAN PRESIDENT
RADEL CASTRO TO NEW YORK CITY,
SEPTEMBER 4 - 6, 1981

PFO
 OO: NEW YORK

ReButel, 8/27/81.

Established sources in the Atlanta Division, who are knowledgeable concerning Cuban activities, were able to provide no information that Castro would be the target of violence during his visit to New York City.

1*

185-1563-11

- ② - Bureau
- 2 - New York
- 1 - Atlanta

(5)

OCT 5 1981

b6
b7C

Approved: [Signature]

Transmitted _____ (Number) _____ (Time)

Per _____

FEDERAL BUREAU OF INVESTIGATION
FOI/PA
DELETED PAGE INFORMATION SHEET
FOI/PA# 1362425-000

Total Deleted Page(s) = 23

- Page 4 ~ Duplicate;
- Page 5 ~ Duplicate;
- Page 7 ~ Duplicate;
- Page 8 ~ Duplicate;
- Page 9 ~ Duplicate;
- Page 10 ~ Duplicate;
- Page 11 ~ Duplicate;
- Page 12 ~ Duplicate;
- Page 13 ~ Duplicate;
- Page 14 ~ Duplicate;
- Page 15 ~ Duplicate;
- Page 16 ~ Duplicate;
- Page 17 ~ Duplicate;
- Page 18 ~ Duplicate;
- Page 19 ~ Duplicate;
- Page 20 ~ Duplicate;
- Page 21 ~ Duplicate;
- Page 22 ~ Duplicate;
- Page 23 ~ Duplicate;
- Page 24 ~ Duplicate;
- Page 25 ~ Duplicate;
- Page 26 ~ Duplicate;
- Page 27 ~ Duplicate;

```
XXXXXXXXXXXXXXXXXXXXXXXXXXXXX  
X Deleted Page(s) X  
X No Duplication Fee X  
X For this Page X  
XXXXXXXXXXXXXXXXXXXXXXXXXXXXX
```

UNITED STATES DEPARTMENT OF JUSTICE
FEDERAL BUREAU OF INVESTIGATION

MEMORANDUM

DATE: 8/28/81

TO : SAC II

FROM : SUPV.

b6
b7C

SUBJECT: TITLE OF CASE *Visit of Field Center; PFE 0014*

On 8/28/81 I authorized, in accordance with the Attorney General's Guidelines on Criminal Investigations of Individuals and Organizations, a (General Crimes) (~~Preliminary~~) (~~Racketeering Enterprise~~) investigation based upon:

- (a) The following facts or circumstances, or
- (b) the facts and circumstances contained in the attached documents. 8/27/81

b6
b7C

MAINTAIN AS TOP SERIAL.

DATES OF SUBSEQUENT REVIEW OF JURISDICTION RECORDED

ON BACK.

Memorandum



To : SAC (185-1076) C

Date 3/15/82

From : SA

b6
b7C

Subject : POSSIBLE VISIT OF CUBAN PRESIDENT
FIDE CASTRO TO NEW YORK,
PFO
OO: NEW YORK

Contact with representatives of U.S. Department of State and U.S. Secret Service have been negative to date re any plans of Castro to visit the United States.

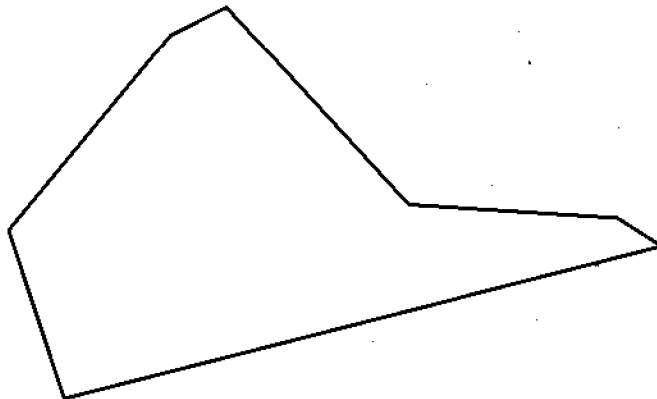

b6
b7C



185-1076-10

SEARCHED	INDEXED
SERIALIZED	FILED
MAR 15 1982	
FBI - New York	

FEDERAL BUREAU OF INVESTIGATION
FOI/PA
DELETED PAGE INFORMATION SHEET
FOI/PA# 1362425-000

Total Deleted Page(s) = 6
Page 3 ~ Duplicate;
Page 4 ~ Duplicate;
Page 5 ~ Duplicate;
Page 6 ~ Duplicate;
Page 9 ~ Duplicate;
Page 10 ~ Duplicate;

XXXXXXXXXXXXXXXXXXXXXXXXXXXX
X Deleted Page(s) X
X No Duplication Fee X
X For this Page X
XXXXXXXXXXXXXXXXXXXXXXXXXXXX

b6
b7C
CI-12

VZCZCH00125 2452301

RR HI MM NY NY WFO

DE SJ MCM3009

R 02250Z SEP 81

FM SAN JUAN (135-70) (P)

TO DIRECTOR ROUTINE

MIAMI ROUTINE

NEW YORK ROUTINE

NEWARK ROUTINE

WFO ROUTINE

BT

No CFR Check

~~CONFIDENTIAL~~

POSSIBLE VISIT OF CUBAN PRESIDENT FIDEL CASTRO TO NEW YORK
CITY, SEPTEMBER 4-6, 1981; PFO; OO: NEW YORK

THIS ENTIRE COMMUNICATION CLASSIFIED "~~CONFIDENTIAL~~" UNLESS
OTHERWISE NOTED.

RE BUTEL TO ALL OFFICES, AUGUST 27, 1981.

ON SEPTEMBER 2, 1981, [redacted] A SOURCE OF PROVEN
RELIABILITY, WAS CONTACTED RE CAPTIONED MATTER.

b7D

SOURCE STATED THAT HE HAS NOT DEVELOPED ANY INFORMATION
PERTAINING TO ANY ACTIVITIES BY ANTI-CASTRO GROUPS RE POSSIBLE
VISIT OF CUBAN PRESIDENT FIDEL CASTRO.

185-1010-2
SEARCHED [] INDEXED []
SERIALIZED [] FILE []

SEP 2 7 09 PM '81

FBI-WASH DC []

b6
b7C

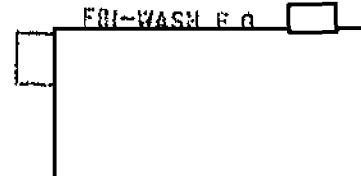
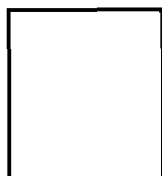

.PAGE TWO SJ 185-79 ~~C O N F I D E N T I A L~~

SOURCE, HOWEVER, DID STATE THAT [REDACTED]

b7D

[REDACTED]

SOURCE STATED THAT [REDACTED]

[REDACTED]

b7D

SOURCE STATED THAT [REDACTED]

[REDACTED]

b6
b7C
b7D

SOURCE CLAIMS [REDACTED]

[REDACTED]

b7D

SOURCE STATED [REDACTED]

[REDACTED]

b7D

~~C & F 10239; REASONS 2 & 3; DRD SEPTEMBER 2, 2001.~~

BT

Memorandum



To SAC, WFO (185-1010) *(RUC)*

Date 10/19/81

From SA [redacted]

b6
b7C

Subject: POSSIBLE VISIT OF CUBAN PRESIDENT
FIDEL CASTRO TO NEW YORK CITY
SEPTEMBER 4-6, 1981;
PFO
(OO:NY)

On 8/31/81, [redacted]
[redacted]
was contacted and was advised that writer was coordinating
the Federal Bureau of Investigation (FBI), Washington
Field Office (WFO) interest in captioned visit.

b6
b7C
b7E

[redacted] was recontacted on 9/14/81 and 9/17/81.
[redacted] advised that the Castro visit was being postponed.

On 10/13/81, [redacted] advised that the Castro visit
may not take place.

In view of the above, WFO is *close* RUCing instant case.

[redacted] *(1)* - WFO
[redacted]
(1)

close
10-19-81
10/19/81
[redacted]

185-1010-3

SEARCHED	INDEXED
SERIALIZED	FILED
OCT 23 1981	
FBI-WASH. FIELD OFFICE	

[redacted]

b6
b7C

FEDERAL BUREAU OF INVESTIGATION
FOI/PA
DELETED PAGE INFORMATION SHEET
FOI/PA# 1362425-000

Total Deleted Page(s) = 3
Page 4 ~ Duplicate;
Page 5 ~ Duplicate;
Page 6 ~ Duplicate;

XXXXXXXXXXXXXXXXXXXXXXXXXXXX
X Deleted Page(s) X
X No Duplication Fee X
X For this Page X
XXXXXXXXXXXXXXXXXXXXXXXXXXXX

- 1 -

FEDERAL BUREAU OF INVESTIGATION

Date of transcription 10/10/2006

MIGUEL LUIS TALLEDA, date of birth June 14, 1919, was interviewed at his residence, [redacted] Torrance, California. TALLEDA's home telephone number is [redacted] Also present for the interview was [redacted] and [redacted] Detective, Torrance Police Department. After being advised of the identity of the interviewing agent and officer, TALLEDA provided the following information:

b6
b7C

TALLEDA had never heard of [redacted] [redacted] ALPHA 66 issued a statement locally and nationally through the Cuban journal "VEINTE DE MAYO" that [redacted] is not a member of ALPHA 66, nor do they know him. TALLEDA opined that [redacted] may have been dealing with gangs. There was an article on [redacted] written in the Spanish language posted [redacted] at the Website www.granma.cu.

b6
b7C

TALLEDA is the ALPHA 66 Coordinator for California and an ALPHA 66 National Executive. TALLEDA has been a member of ALPHA 66 since 1963. He came to the United States from Cuba in 1962, originally staying in Miami, Florida. Approximately 45-days later TALLEDA moved to Alhambra, California and then to Torrance, where he has remained for the past 30 years. He moved from Florida because he was only able to find jobs that required heavy labor and he was used to working as an accountant at a sugar mill office. TALLEDA tried two or three jobs in Southern California before he got his current job at a furniture store called HAMMER FURNITURE located in Gardena, California. TALLEDA still works there two-days per week.

TALLEDA showed interviewing agent his ALPHA 66 identification card which was issued in Miami, Florida on September 2, 1991 by then ALPHA 66 Secretary General ANDRES NAZARIO SARGEN (deceased as of approximately two years ago). The identification card is driver's license size, orange in color, with a green diagonal stripe with "ALPHA 66" written inside the diagonal stripe in white letters. There are no membership dues, but donations are accepted. ALPHA 66 does not conduct any background investigations on members, but they closely watch new members.

When ALPHA 66 has a banquet, a lot of Cubans attend. They also have a large, annual Christmas party in the Los Angeles

Investigation on 10/6/2006 at Torrance, California

File # [redacted] Date dictated _____

by SA [redacted]

b6
b7C
b7E

[REDACTED]

b7E

Continuation of FD-302 of Miguel Luis Talleda, On 10/6/2006, Page 2

area. Los Angeles area meetings are held every one or two months at local restaurants or TALLEDA's home or other members' homes. TALLEDA's group has no intention of setting up a commando team.

The current [REDACTED] of ALPHA 66 is [REDACTED]

b6
b7C

[REDACTED]

ALPHA 66 was founded by 66 Cuban exiles in Puerto Rico in November 1961. Membership has gotten smaller due to gas prices and aging members. There are approximately 1,000 members in the United States. New York, New Jersey, San Francisco, Chicago, and Miami (ALPHA 66 Headquarters) all have substantial membership. There are approximately 100 members in the Los Angeles, California area and 10-20 members in San Diego, California. The ALPHA 66 Miami Headquarters maintains membership lists and TALLEDA would not provide a membership list.

ALPHA 66 did some commando raids into Cuba in the 1970s. TALLEDA never went on any of these raids nor has he received any military training or served in any military. ALPHA 66 does not have any current plans to invade Cuba, especially because of the strict homeland security rules and U.S. Coast Guard presence between Florida and Cuba. ALPHA 66 has membership in Cuba but ALPHA 66 keeps their identities secret to protect these members as the Cuban government considers ALPHA 66 terrorists.

Circa 1980-1981, ALPHA 66 had a training camp in the mountains of the Mojave Desert in California. The FBI visited this site, but ALPHA 66 did not have anything to hide. They used the camp to teach Cubans how to fight and shoot firearms. It was more of a propaganda campaign for publicity and was used by ALPHA 66 members from Southern California. They had to close the camp.

People in the United States listening to the radio and reading the newspapers don't care how dangerous CASTRO is. Americans are more aware of what is happening in Latin America because of HUGO CHAVEZ's recent inflammatory remarks regarding PRESIDENT GEORGE W. BUSH. CHAVEZ is running Cuba because he provides Cuba with oil.

Recounting his experience from the Cuban Revolution, TALLEDA indicated they fought BATISTA for seven years and then FIDEL CASTRO took over, and since he was another dictator they fought him. TALLEDA saw CASTRO in person on only one occasion when

[REDACTED]

b7E

Continuation of FD-302 of Miguel Luis Talleda, On 10/6/2006, Page 3

TALLEDA and some of his colleagues were putting flowers at a bridge where two of their comrades were killed fighting BATISTA. CASTRO also fought against BATISTA.

[REDACTED]

b3
b7E

TALLEDA believes the CASTRO regime will be overtaken in TALLEDA's lifetime. [REDACTED] is just as dangerous as FIDEL CASTRO. [REDACTED] used to execute BATISTA's captured soldiers. TALLEDA believed there are a lot of plans in the works to overthrow CASTRO. Eighty-five to 90 percent of Cubans are against CASTRO. Infiltrations into Cuba occurred into the 1980s, but they were caught and killed.

b6
b7C

ALPHA 66 does not send money to Cuba because CASTRO will take it. They use money to maintain their offices in Miami and New York, and a training camp in Miami. They use the training camp for shooting firearms.

ALPHA 66 is friendly with everyone in Cuba who is against CASTRO. There are journalists in Cuba who are friendly with the American Embassy in Havana, Cuba. Most Cubans are Republicans because most Democrats like CASTRO. ALPHA 66's Website is www.Alpha66.org. TALLEDA wrote a book on ALPHA 66 in the Spanish language, entitled "ALPHA 66 Y SU HISTORICA TAREA".

TALLEDA is very pro-American and harbors no ill-will toward Americans or the United States. TALLEDA believes the only way to get rid of CASTRO is through violent overthrow.

TALLEDA had been contacted by the FBI circa 20 years-ago. The special agent's name was first name unknown, last name [REDACTED]

TALLEDA was interviewed by reporter [REDACTED] regarding ALPHA 66 on a Torrance television news station a few months ago. TALLEDA showed interviewing agent and officer the news segment on DVD.

b6
b7C

FEDERAL BUREAU OF INVESTIGATION
FOI/PA
DELETED PAGE INFORMATION SHEET
FOI/PA# 1362425-000

Total Deleted Page(s) = 8

- Page 29 ~ Duplicate;
- Page 44 ~ Duplicate;
- Page 45 ~ Duplicate;
- Page 46 ~ Duplicate;
- Page 60 ~ Duplicate;
- Page 61 ~ Duplicate;
- Page 125 ~ Duplicate;
- Page 126 ~ Duplicate;

```
XXXXXXXXXXXXXXXXXXXXXXXXXXXXX  
X Deleted Page(s) X  
X No Duplication Fee X  
X For this Page X  
XXXXXXXXXXXXXXXXXXXXXXXXXXXXX
```

For Informational Purposes Only

The originals removed from this file and replaced with duplicate copies of the original were accessioned to the National Archives and Records Administration (NARA) pursuant to the JFK Records Collection Act of 1992. Provision of the JFK Act allowed for certain information to be postponed from public release until the year 2017; therefore, the pages have NOT necessarily been released for public review in their entirety.

Under the JFK Act, originals to all material deemed assassination records must be accessioned to NARA regardless of whether the material is open in full or released with information postponed. Therefore, any documents or pages from FBI files accessioned to NARA pursuant to the JFK Act are no longer considered the possession of the FBI. The duplicate pages have been inserted strictly for research purposes.

The copies contained herein do not necessarily show the most up-to-date classification.

To attain a copy of the publicly released version of any materials maintained in the JFK Collection at the NARA facility in College Park, MD, you may contact the JFK Access Staff, at 301/713-6620.

The following materials were removed from this file and are maintained in the JFK Collection at NARA:

File & Serial Number

JFK Subject Identifier
(for NARA purposes)

105 - 142517-1

Church Committee

For Informational Purposes Only

For Informational Purposes Only

The originals removed from this file and replaced with duplicate copies of the original were accessioned to the National Archives and Records Administration (NARA) pursuant to the JFK Records Collection Act of 1992. Provision of the JFK Act allowed for certain information to be postponed from public release until the year 2017; therefore, the pages have NOT necessarily been released for public review in their entirety.

Under the JFK Act, originals to all material deemed assassination records must be accessioned to NARA regardless of whether the material is open in full or released with information postponed. Therefore, any documents or pages from FBI files accessioned to NARA pursuant to the JFK Act are no longer considered the possession of the FBI. The duplicate pages have been inserted strictly for research purposes.

The copies contained herein do not necessarily show the most up-to-date classification.

To attain a copy of the publicly released version of any materials maintained in the JFK Collection at the NARA facility in College Park, MD, you may contact the JFK Access Staff, at 301/713-6620.

The following materials were removed from this file and are maintained in the JFK Collection at NARA:

File & Serial Number

JFK Subject Identifier
(for NARA purposes)

105-142517-2

Church Committee

For Informational Purposes Only

Date

7-8-65

To:

Bureau

Director (RM)

FILE # Chicago

Att.: _____

SAC _____

Title PLOT TO ASSASSINATE

ASAC _____

PREMIER FIDEL CASTRO

Supv. _____

DURING OCTOBER

Agent _____

HOLIDAYS, 1965.

SE

IS-Cuba

IC _____

CC _____

Rebu R/S dtd 7-2-65

Steno _____

Clerk _____

ACTION DESIRED

- | | |
|--|---|
| <input type="checkbox"/> Acknowledge | <input type="checkbox"/> Open Case |
| <input type="checkbox"/> Assign _____ Reassign _____ | <input type="checkbox"/> Prepare lead cards |
| <input type="checkbox"/> Bring file | <input type="checkbox"/> Prepare tickler |
| <input type="checkbox"/> Call me | <input type="checkbox"/> Recharge serials |
| <input type="checkbox"/> Correct | <input type="checkbox"/> Return assignment card |
| <input type="checkbox"/> Deadline _____ | <input type="checkbox"/> Return file |
| <input type="checkbox"/> Deadline passed | <input type="checkbox"/> Return serials |
| <input type="checkbox"/> Delinquent | <input type="checkbox"/> Search and return |
| <input type="checkbox"/> Discontinue | <input type="checkbox"/> See me |
| <input type="checkbox"/> Expedite | <input type="checkbox"/> Send Serials _____ |
| <input type="checkbox"/> File | to <u>File</u> |
| <input type="checkbox"/> For information | <input type="checkbox"/> Submit new charge out |
| <input type="checkbox"/> Initial & return | <input type="checkbox"/> Submit report by _____ |
| <input type="checkbox"/> Leads need attention | <input type="checkbox"/> Type |
| <input type="checkbox"/> Return with explanation or notation as to action taken. | |

b6

b7C

Pursuant to above referenced R/S CG has furnished 1 copy each of CG LHM's dated 6-24 and 6-25-65. to U.S. Secret Service, Chicago.

Attached are 2 copies of FD 376 used as _____ SAC M. W. JOHNSON

transmitted **ENCLOSURE**

See reverse side

Office

CHICAGO

N

letter to Secret Service

already sent SS mail 7/11/65

NA

SEC.

(Copies to Offices Checked)

TO: SAC

- Albany
- Albuquerque
- Anchorage
- Atlanta
- Baltimore
- Birmingham
- Boston
- Buffalo
- Butte
- Charlotte
- Chicago
- Cincinnati
- Cleveland
- Dallas
- Denver
- Detroit
- El Paso
- Honolulu

- Houston
- Indianapolis
- Jackson
- Jacksonville
- Kansas City
- Knoxville
- Las Vegas
- Little Rock
- Los Angeles
- Louisville
- Memphis
- Miami
- Milwaukee
- Minneapolis
- Mobile
- Newark
- New Haven
- New Orleans

- New York City
- Norfolk
- Oklahoma City
- Omaha
- Philadelphia
- Phoenix
- Pittsburgh
- Portland
- Richmond
- St. Louis
- Salt Lake City
- San Antonio
- San Diego
- San Francisco
- San Juan
- Savannah
- Seattle
- Springfield

- [Redacted] Field
- Quantico

TO LEGAT:

- Bern
- Bonn
- London
- Manila
- Mexico, D.F.
- Ottawa
- Paris
- Rome
- Rio de Janeiro
- Tokyo

b6
b7C

Date 2/2/65

RE:

*PLOT TO ASSASSINATE PREMIER
FIDEL CASTRO DURING OCTOBER
HOLIDAYS, 1965
IS - CUBA*

- For information optional For appropriate action Surep, by _____
- The enclosed is for your information. If used in a future report, conceal all sources, paraphrase contents.
- Enclosed are corrected pages from report of SA _____ dated _____

Remarks:

*Reur antels 6/24 + 25/65 with
encl. Furnish copy each
enlosure to Secret Service
locally, category 1.*

Enc.
Bufile
Urfile

[Redacted]

SEARCHED _____	INDEXED _____
SERIALIZED _____	FILED _____
FEB 2 1965	
FBI - CHICAGO	

b3
b7E

105-142517

NOT RECORDED

1 JUL 16 1965

17/
JUL 21 1965



UNITED STATES DEPARTMENT OF JUSTICE

FEDERAL BUREAU OF INVESTIGATION

219 South Dearborn Street

Chicago, Illinois 60604

WASHINGTON, D.C. 20535

July 8, 1965

In Reply, Please Refer to
File No.

Chief
United States Secret Service
Department of the Treasury
Washington, D. C. 20220

Dear Sir:

The information furnished herewith concerns an individual who is believed to be covered by the agreement between the FBI and Secret Service concerning Presidential protection, and to fall within the category or categories checked.

1. Has attempted or threatened bodily harm to any government official or employee, including foreign government officials residing in or planning an imminent visit to the U. S., because of his official status.
2. Has attempted or threatened to redress a grievance against any public official by other than legal means.
3. Because of background is potentially dangerous; or has been identified as member or participant in communist movement; or has been under active investigation as member of other group or organization inimical to U. S.
4. U. S. citizens or residents who defect from the U. S. to countries in the Soviet or Chinese Communist blocs and return.
5. Subversives, ultrarightists, racists and fascists who meet one or more of the following criteria:
 - (a) Evidence of emotional instability (including unstable residence and employment record) or irrational or suicidal behavior;
 - (b) Expressions of strong or violent anti-U. S. sentiment;
 - (c) Prior acts (including arrests or convictions) or conduct or statements indicating a propensity for violence and antipathy toward good order and government.
6. Individuals involved in illegal bombing or illegal bomb-making.

Photograph has been furnished enclosed is not available
 may be available through _____

Very truly yours,

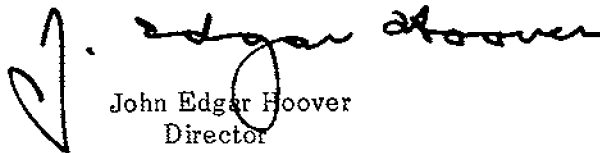
John Edgar Hoover
Director

1 - Special Agent in Charge (Enclosure(s))
U. S. Secret Service

Enclosure(s)

(Upon removal of classified enclosures, if any, this transmittal form
becomes UNCLASSIFIED.)

UNITED STATES GOVERNMENT

Memorandum

- 1 - Mr. Belmont
- 1 - Mr. Mohr
- 1 - Mr. DeLoach
- 1 - Mr. Sullivan



- Tolson _____
- Belmont _____
- Mohr _____
- DeLoach _____
- Casper _____
- Callahan _____
- Conrad _____
- Felt _____
- Gale _____
- Rosen _____
- Sullivan _____
- Tavel _____
- Trotter _____
- Tele. Room _____
- Holmes _____
- Gandy _____

b6
b7C

TO : W. C. SULLIVAN

DATE: July 8, 1965

FROM :



SUBJECT: PLOT TO ASSASSINATE PREMIER
FIDEL CASTRO DURING OCTOBER
HOLIDAYS, 1965
INTERNAL SECURITY - CUBA

b6
b7C

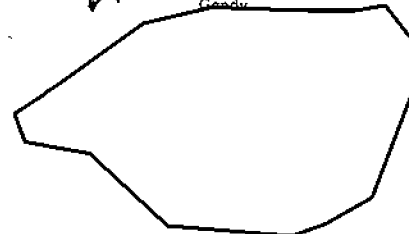

Chicago source has furnished information concerning Cuban refugee plot to assassinate Castro in October, 1965.

b6
b7C
b7D



has advised our Chicago Office

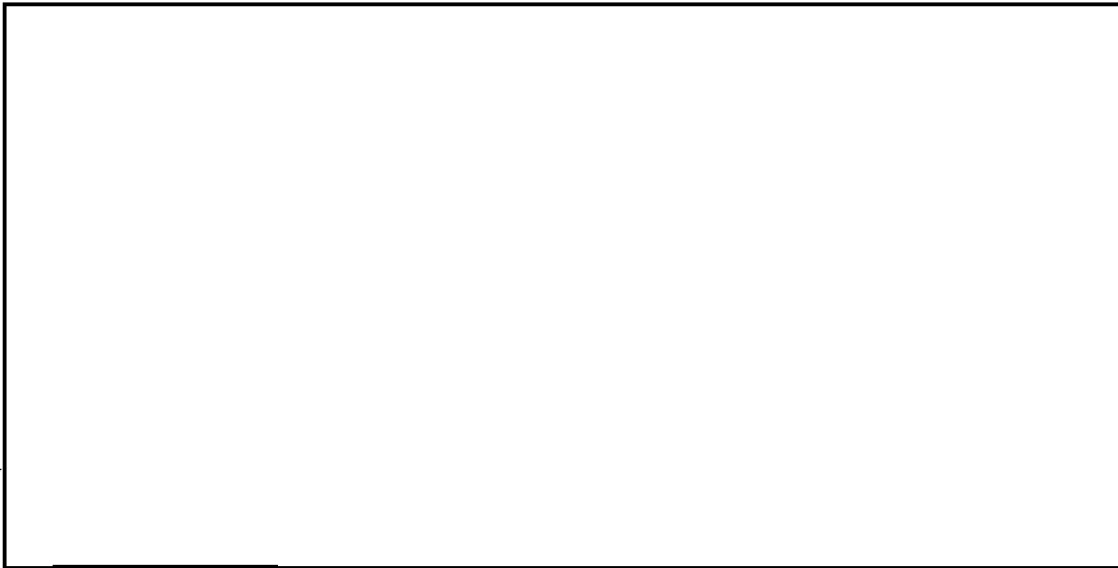

b3
b7D
b7E

REC 5 / 105 - 142517 J

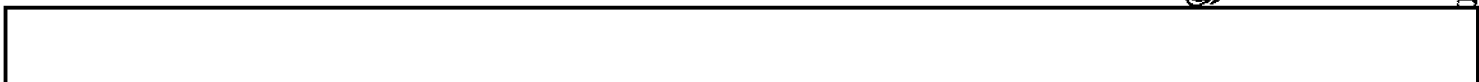

(Castro)

6 JUL 9 1965

(9)

CONTINUED - OVER

b3
b6
b7C
b7E

51 JUL 16 1965

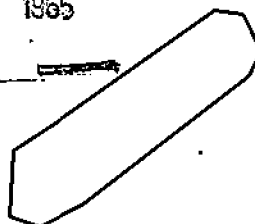

UNRECORDED COPY FILED IN

Memorandum [redacted] to W. C. Sullivan
RE: PLOT TO ASSASSINATE PREMIER
FIDEL CASTRO DURING OCTOBER
HOLIDAYS, 1965

b3
b6
b7C
b7E

Since Bureau files indicated that [redacted]

[redacted]
Our information has been disseminated to State, [redacted]
[redacted] Army, Navy, Air Force, [redacted]
Customs, Coordinator for Cuban Affairs, Secret Service and Internal Security
Division of the Department.

b3
b7E

On basis of data now available there does not appear to be
violation within our jurisdiction. However, since this could possibly
evolve into violations [redacted] it is
being closely followed.

ACTION:

For information.

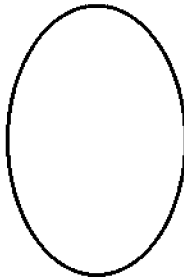
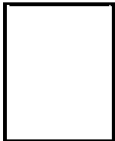

b6
b7C

UNITED STATES GOVERNMENT

Memorandum

TO : DIRECTOR, FBI [redacted]

FROM : *J* SAC, MIAMI [redacted] (P)

SUBJECT: PLOT TO ASSASSINATE PREMIER FIDEL CASTRO DURING OCTOBER HOLIDAYS, 1965
IS - CUBA

~~SECRET~~

DATE: JUL 19 1965

10-23-94
Classified by [redacted]
Declassify on: OADR (JFK)

b3
b6
b7C
b7E

~~ALL INFORMATION CONTAINED
HEREIN IS UNCLASSIFIED EXCEPT
WHERE SHOWN OTHERWISE.~~

ReBuairtel to Miami 7/8/65.

Enclosed herewith are 12 copies of a letterhead memorandum dated and captioned as above.

Copies are being disseminated locally to the following agencies: INS, [redacted] Coordinator of Cuban Affairs - State Department, Border Patrol, Customs - Miami, Region II, Miami, and Key West, Coast Guard,

b3
b6
b7C
b7D
b7E

MM T-1 is [redacted]

MM T-2 is [redacted]

MM T-3 is [redacted]

MM T-4 is [redacted]

MM T-5 is [redacted]

0-7 Chicago - Re Miami let 7/19/65
with encl: Form 1, 4, 14
of encl to Bureau Bureau, Chicago
8/13/65

DECLASSIFIED BY [redacted]
ON 3-2-98 (JFK)

On July 5, 1965, U. S. Customs, Miami, advised that they had no information concerning the [redacted] or that [redacted] was involved in any assassination plot.

- 2 - Bureau (Enc-12) (RM)
- 2 - Chicago [redacted] (Enc-2) (RM)
- 1 - Miami

[redacted] (5)

18 JUL 21 1965

b3
b6
b7C
b7E

12 ENCLOSURE

Copy to: [redacted] State/Sec [redacted] Div. / Secret Service - Category 1
[redacted] Customs / Kimmins / SEC

by routing slip for info
Date: 9/3/65 by [redacted]



55 AUG 6 1965 Buy U.S. Savings Bonds Regularly on the Payroll Savings Plan

UNREC COPY AND COPY OF ENCL FILED IN

[Redacted]

~~SECRET~~

b3
b7E

Copies of the letterhead memoranda prepared by the Chicago Office in this matter will be disseminated locally to federal agencies in Miami.

~~SECRET~~

[Redacted] said [Redacted]

[Redacted]

b6
b7C
b7D

The Miami Office will maintain contact with [Redacted] and other established sources and informants and will keep the Bureau advised.

b7D

- LEAD -

MIAMI

AT MIAMI, FLORIDA

Will contact [Redacted] to ascertain [Redacted]

[Redacted]

(S) (u)

b3
b6
b7C
b7E

It is noted that according to [Redacted]

[Redacted]

b6
b7C
b7D

~~SECRET~~

~~SECRET~~

See memo 6



UNITED STATES DEPARTMENT OF JUSTICE
FEDERAL BUREAU OF INVESTIGATION

In Reply, Please Refer to
File No. [redacted]

Miami, Florida

JUL 19 1965

b3
b6
b7C
b7E

[redacted] 5/28/98-JFR
ALL INFORMATION CONTAINED
HEREIN IS UNCLASSIFIED
DATE 10-23-94 BY [redacted]

(JFK)

RE: PLOT TO ASSASSINATE PREMIER
FIDEL CASTRO DURING OCTOBER
HOLIDAYS, 1965
INTERNAL SECURITY - CUBA

It was previously reported that ^{JK} in June, 1965,

b6
b7C
b7D

[redacted]
MM T-1, a Cuban exile who has been active in [redacted]
revolutionary matters for the past five years, on July 1, [redacted]
1965, advised that [redacted]

b6
b7C
b7D

b6
b7C
b7D

1
AUG 4 1965
XE.01

105-142517-4
ENCLOSURE

b6
b7C

PLOT TO ASSASSINATE PREMIER FIDEL CASTRO
DURING OCTOBER HOLIDAYS, 1965

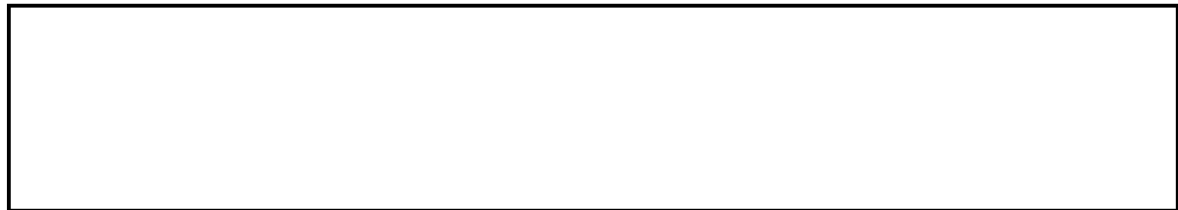

b7D

MM T-2, a Cuban exile involved in revolutionary matters for the past eight years, on July 2, 1965, stated that



b6
b7C
b7D

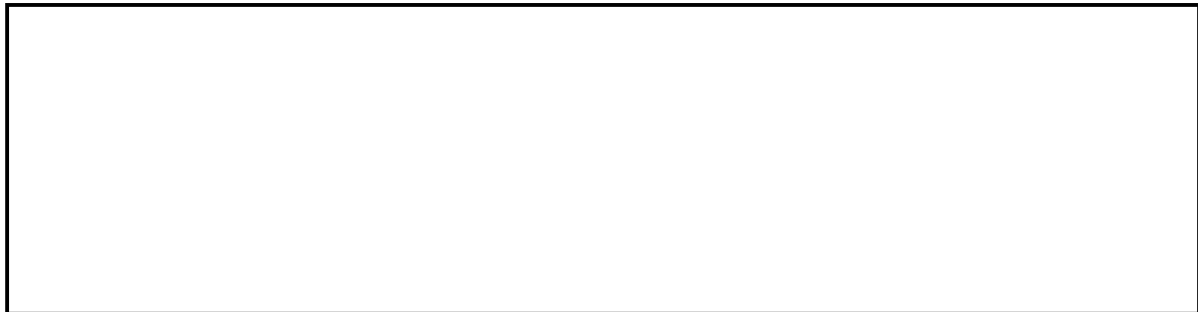

b6
b7C
b7D

PLOT TO ASSASSINATE PREMIER FIDEL CASTRO
DURING OCTOBER HOLIDAYS, 1965

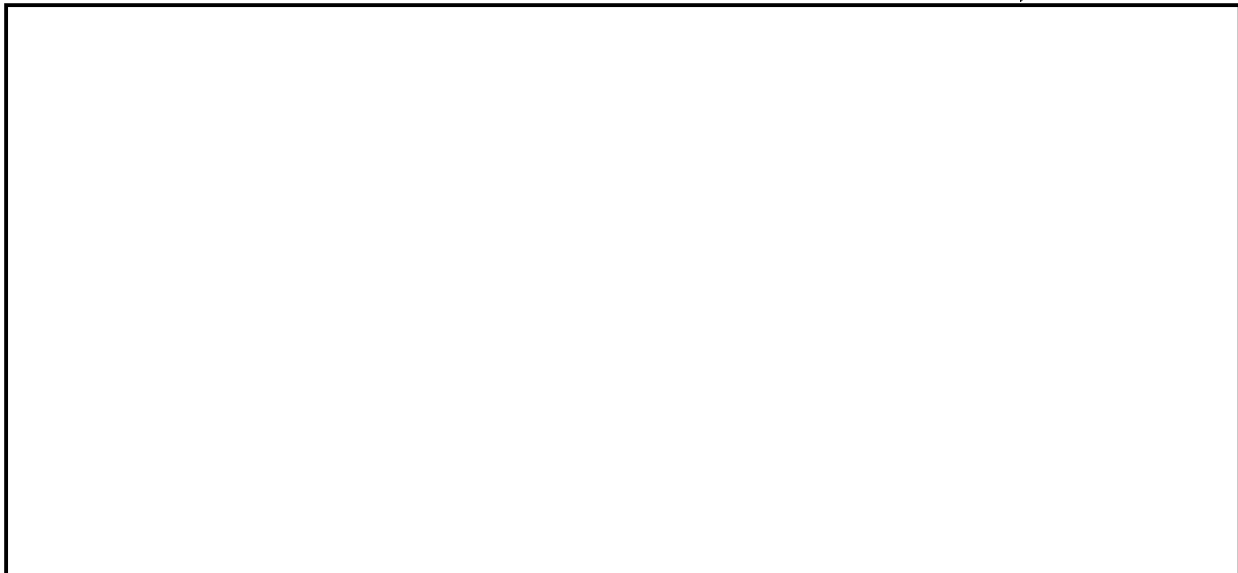

b6
b7C
b7D

MM T-3 and MM T-4, who have been active in Cuban revolutionary matters for the past six years, furnished substantially the same information concerning [redacted] and stated it would be highly unlikely that he would be involved in any assassination attempt against FIDEL CASTRO.

b6
b7C

MM T-5, who has been involved in Cuban revolutionary activities for the past six years, stated [redacted]

b6
b7C
b7D

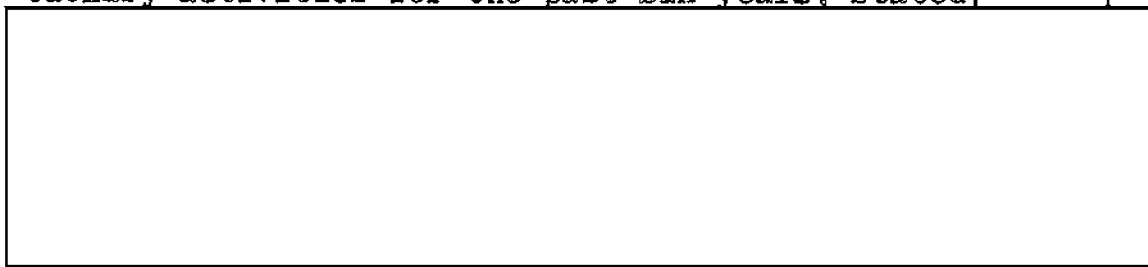

MM T-5 stated on July 7, 1965, that [redacted]

b6
b7C
b7D

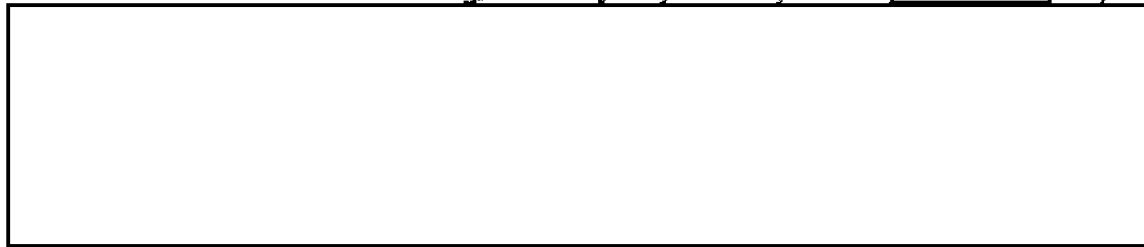

PLOT TO ASSASSINATE PREMIER FIDEL CASTRO
DURING OCTOBER HOLIDAYS, 1965

[REDACTED]

b6
b7C
b7D

MM T-5 explained that [REDACTED]

[REDACTED]

b6
b7C
b7D

MM T-1 through MM T-5, mentioned above, advised that they did not know [REDACTED] and could furnish no information concerning him.

b6
b7C

This document contains neither recommendations nor conclusions of the FBI. It is the property of the FBI and is loaned to your agency; it and its contents are not to be distributed outside your agency.

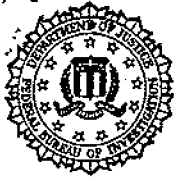

UNITED STATES DEPARTMENT OF JUSTICE
FEDERAL BUREAU OF INVESTIGATION

Miami, Florida

JUL 19 1965

In Reply, Please Refer to
File No.

b3
b7E

Title	PLOT TO ASSASSINATE PREMIER FIDEL CASTRO DURING OCTOBER HOLIDAYS, 1965
Character	INTERNAL SECURITY - CUBA
Reference	Memorandum dated and captioned as above at Miami, Florida

All sources (except any listed below) whose identities are concealed in referenced communication have furnished reliable information in the past.

FBI

Date: 7/20/65

Transmit the following in _____

(Type in plaintext or code)

Via AIRTEL

(Priority)

Mr. Tolson	_____
Mr. Belmont	_____
Mr. Mohr	_____
Mr. DeLoach	_____
Mr. Casper	_____
Mr. Callahan	_____
Mr. Conrad	_____
Mr. Felt	_____
Mr. Gale	_____
Mr. Rosen	_____
Mr. Sullivan	_____
Mr. Tavel	_____
Mr. Trotter	_____
Tele. Room	_____
Miss Holmes	_____
Miss Gandy	_____

TO : DIRECTOR, FBI [redacted]

FROM : SAC, CHICAGO [redacted]

SUBJECT: PLOT TO ASSASSINATE PREMIER FIDEL CASTRO DURING OCTOBER HOLIDAYS, 1965
ANTI-FIDEL CASTRO ACTIVITIES
IS - CUBA

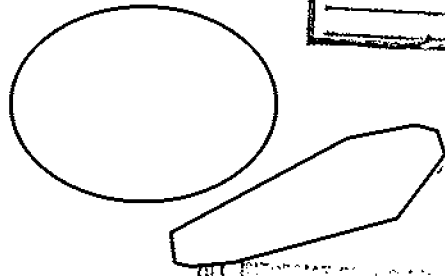

ALL INFORMATION CONTAINED HEREIN IS UNCLASSIFIED DATE 5/28/98 BY [redacted]

b3
b6
b7C
b7E

Re Chicago airtel to Bureau 7/14/65.

Enclosed for the Bureau are twelve copies, for Miami two copies and for Washington Field one copy of a letterhead memorandum dated and captioned as above.

The source mentioned in the letterhead memorandum is [redacted]

b6
b7C
b7D

Chicago is furnishing U. S. Secret Service locally a copy of the letterhead memorandum by FD-376.

Chicago will continue to maintain close contact with [redacted] and will remain alert to any other information concerning this plot and its participants.

EX-100

- (3) - Bureau (RM) (Encls. 12)
- 2 - Miami [redacted] (Encls. 2) (RM)
- 1 - Washington Field (Encl. 1) (Info) (RM)
- 3 - Chicago

b3
b6
b7C
b7E

JUL 21 1965

Copy to: [redacted] State/FAO [redacted] Customs/Secret Service
(9) [redacted] Criminals - Coordinator for Cuban [redacted]

by routing slip, for info.

Date..... 7/21/65 by..... [redacted]

Approved: [Signature] Special Agent in Charge

Sent _____ M Per [redacted]

E.E. Wick

105-142517



UNITED STATES DEPARTMENT OF JUSTICE

FEDERAL BUREAU OF INVESTIGATION

In Reply, Please Refer to
File No.

Chicago, Illinois
July 20, 1965

PLOT TO ASSASSINATE PREMIER FIDEL
CASTRO DURING OCTOBER HOLIDAYS, 1965

On July 19, 1965, a source, contact with whom has
been insufficient to determine reliability, advised as follows:

[Redacted]

b6
b7C
b7D

[Redacted]

b6
b7C
b7D

[Redacted]

b6
b7C
b7D

ALL INFORMATION CONTAINED
HEREIN IS UNCLASSIFIED
DATE 5/28/98 BY [Redacted]

(JFK)

b6
b7C

PLOT TO ASSASSINATE PREMIER FIDEL
CASTRO DURING OCTOBER HOLIDAYS, 1965

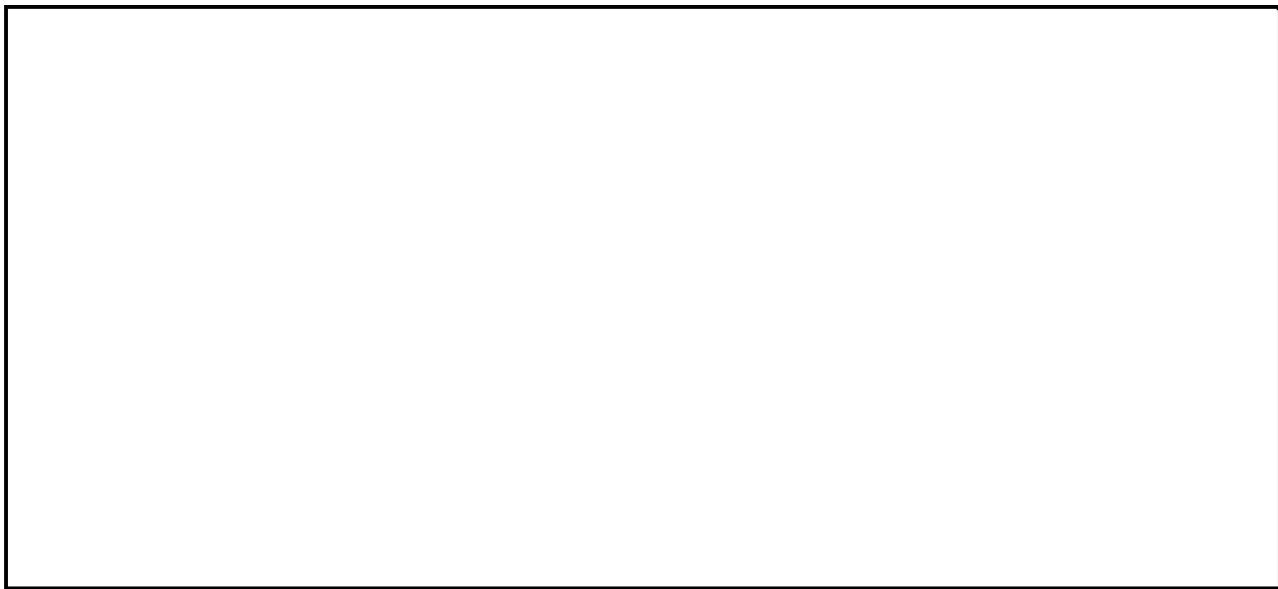

b6
b7C
b7D

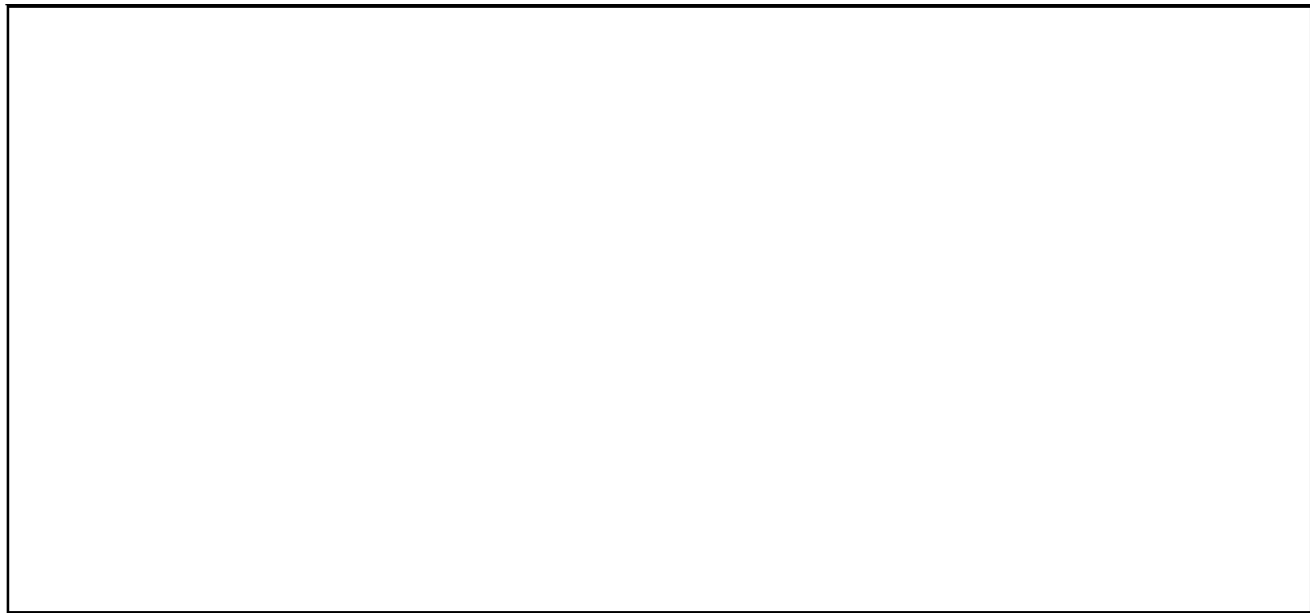

b6
b7C
b7D

The source commented that



b7D

PLOT TO ASSASSINATE PREMIER FIDEL
CASTRO DURING OCTOBER HOLIDAYS, 1965

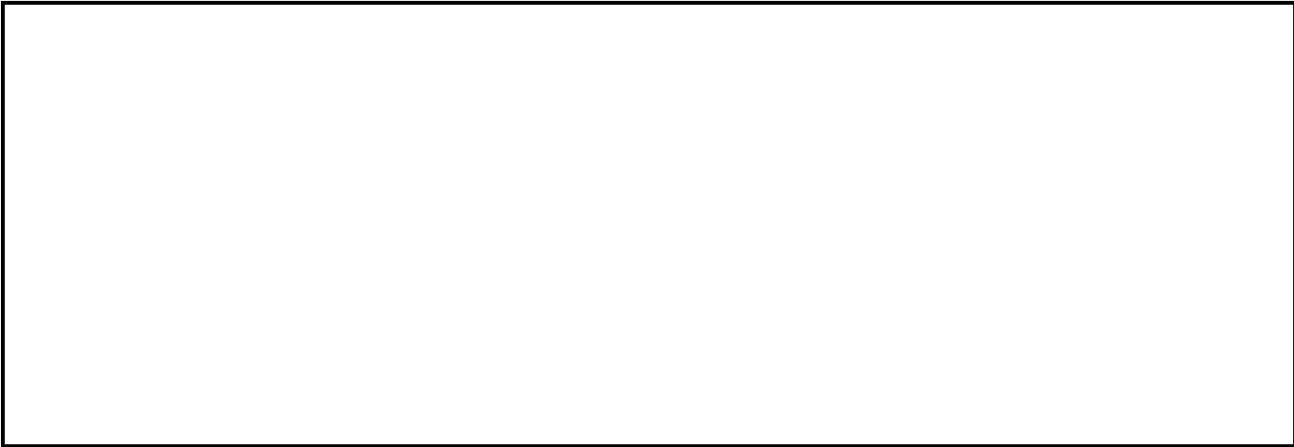

b6
b7C
b7D

On July 19, 1965, records of Eastern Airlines, Northwest Airlines and Delta Airlines were caused to be checked and no information was located concerning travel on the part of anyone named [redacted] to Miami from Chicago on July 16, 1965.

b6
b7C

This document contains neither recommendations nor conclusions of the Federal Bureau of Investigation. It is the property of the Federal Bureau of Investigation and is loaned to your agency; it and its contents are not to be distributed outside your agency.



UNITED STATES DEPARTMENT OF JUSTICE
FEDERAL BUREAU OF INVESTIGATION

Chicago, Illinois
July 20, 1965

WASHINGTON, D.C. 20535

In Reply, Please Refer to
File No.

Chief
United States Secret Service
Department of the Treasury
Washington, D. C. 20220

Dear Sir:

The information furnished herewith concerns an individual who is believed to be covered by the agreement between the FBI and Secret Service concerning Presidential protection, and to fall within the category or categories checked.

1. Has attempted or threatened bodily harm to any government official or employee, including foreign government officials residing in or planning an imminent visit to the U. S., because of his official status.
2. Has attempted or threatened to redress a grievance against any public official by other than legal means.
3. Because of background is potentially dangerous; or has been identified as member or participant in communist movement; or has been under active investigation as member of other group or organization inimical to U. S.
4. U. S. citizens or residents who defect from the U. S. to countries in the Soviet or Chinese Communist blocs and return.
5. Subversives, ultrarightists, racists and fascists who meet one or more of the following criteria:
 - (a) Evidence of emotional instability (including unstable residence and employment record) or irrational or suicidal behavior;
 - (b) Expressions of strong or violent anti-U. S. sentiment;
 - (c) Prior acts (including arrests or convictions) or conduct or statements indicating a propensity for violence and antipathy toward good order and government.
6. Individuals involved in illegal bombing or illegal bomb-making.

Photograph has been furnished enclosed is not available
 may be available through _____

Very truly yours,

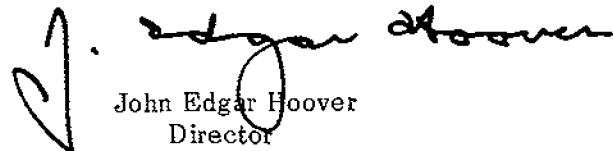
John Edgar Hoover
Director

1 - Special Agent in Charge (Enclosure(s))
U. S. Secret Service

Enclosure(s)

(Upon removal of classified enclosures, if any, this transmittal form becomes UNCLASSIFIED.)

UNITED STATES GOVERNMENT

Memorandum

Tolson _____
 Belmont _____
 Mohr _____
 DeLoach _____
 Casper _____
 Callahan _____
 Conrad _____
 Felt _____
 Gale _____
 Rosen _____
 Sullivan _____
 Tavel _____

TO :

[Redacted]

ALL INFORMATION DATE 11/20/65

~~SECRET~~

FROM :

[Redacted]

~~SECRET~~

place in

Rosen _____ b3
 Sullivan _____ b6
 Tavel _____ b7C
 [Redacted] _____ b7E

SUBJECT:

PLOT TO ASSASSINATE PREMIER FIDEL CASTRO
DURING OCTOBER HOLIDAYS IN 1965
INTERNAL SECURITY - CUBA

~~Declassify on [Redacted]~~

Reference is made to Chicago letterhead memorandum dated 7/14/65, a copy of which was disseminated to [Redacted] Liaison was requested to determine if [Redacted]

b3
 b6
 b7C
 b7E

(JFK)

~~(S)~~ (u)

4-25-91 (JFK)

Chicago
 1-11-65
 1-11-65
 1-11-65

REC 27 / 05-142577-0

EX-101

AUG 5 1965

ACTION:

The above information is being directed to the attention of the Nationalities Intelligence Section

b3
 b6
 b7C
 b7E

- 1 - [Redacted] (Attn. [Redacted])
- 1 - Liaison
- 1 - [Redacted]
- [Redacted] (4)

AUG-6 1965

[Redacted]

4-20-94 / 05-142577

UNRECORDED COPY

1 - [redacted]

8-3-65

b3
b6
b7C
b7E

~~SECRET~~

AIRTEL

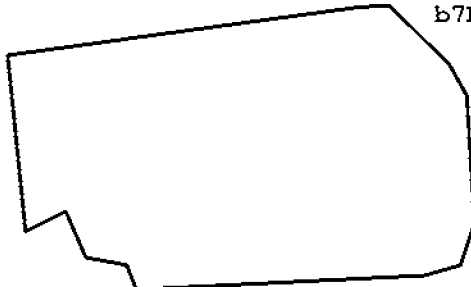

TO: SAC, Chicago [redacted]
FROM: Director, FBI (105-142517)

PLOT TO ASSASSINATE PREMIER FIDEL CASTRO
DURING OCTOBER HOLIDAYS IN 1965
INTERNAL SECURITY - CUBA

Reurairtel 7-14-65 with enclosure.

b3
b6
b7C
b7E

The data contained in the enclosure was made available to [redacted] furnished the

following information: [redacted]

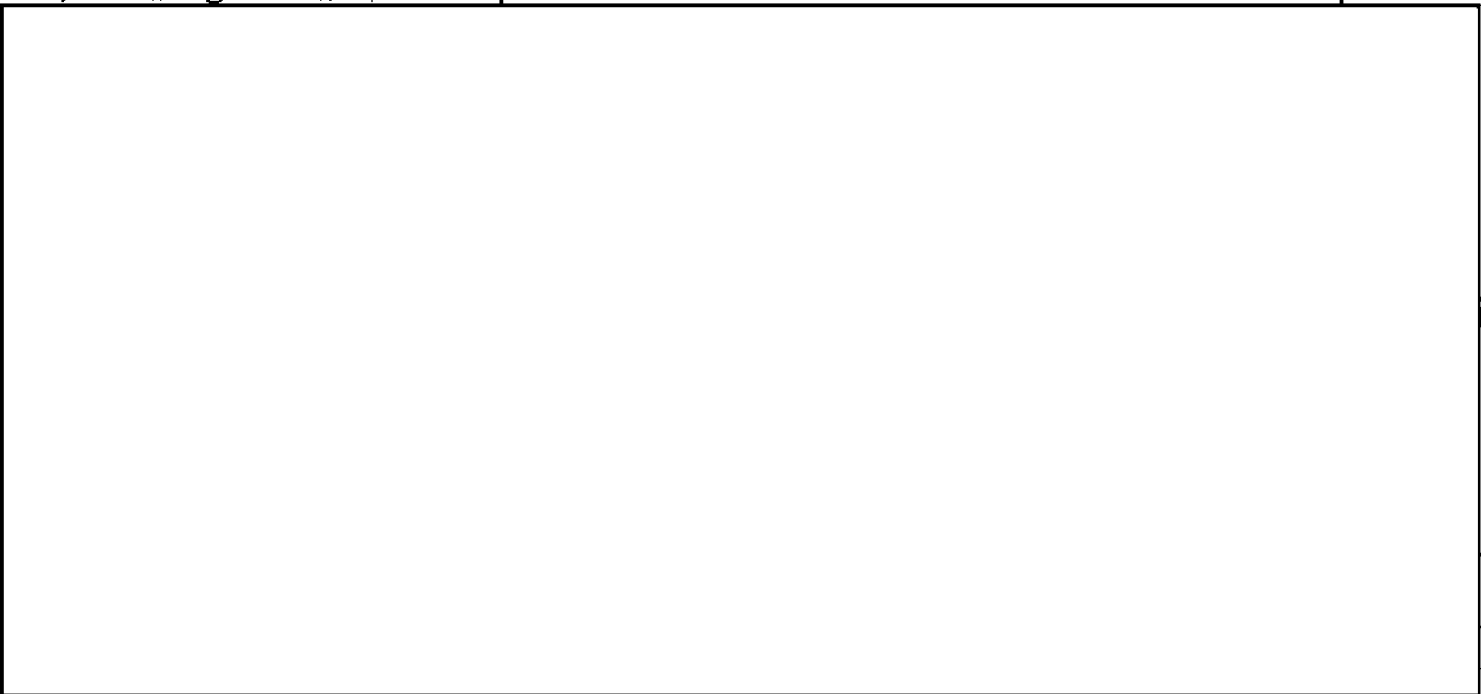

1 - Miami
1 - WFO

- Tolson _____
- Belmont _____
- Mohr _____
- DeLoach _____
- Casper _____
- Callahan _____
- Conrad _____
- Felt _____
- Gale _____
- Rosen _____
- Sullivan _____
- Tavel _____
- Trotter _____
- Tele. Room _____
- Holmes _____
- Gandy _____

~~SECRET~~

CLASSIFIED BY [redacted] 4-25-98 (JFK)

TELETYPE UNIT

WHERE SHOWN

ASSIGNED

6-20-94

MAILED 69

AUG 3 1965

COMM-FBI

SEE NOTE PAGE TWO

(JFK)

(JFK)

b3
b6
b7C
b7E

UNRECORDED COPY F

Airtel to SAC, Chicago
RE: PLOT TO ASSASSINATE PREMIER FIDEL CASTRO
DURING OCTOBER HOLIDAYS IN 1965
105-142517

~~SECRET~~

The foregoing data is for the confidential information of the recipients and must not be disseminated outside the Bureau.

[Redacted]

b3
b6
b7C
b7E

~~(S)~~ (U)

You will be advised of any pertinent information.

revised

In view of the seriousness of this matter, Bureau desires that [Redacted] be interviewed in this matter at the earliest possible time provided these interviews can be conducted without jeopardizing your source in this matter. Carefully review this case with this thought in mind and resubmit your recommendations and comments. Handle by airtel.

b6
b7C

NOTE:

Chicago source furnished information concerning alleged plot to assassinate Castro in October, 1965, [Redacted]

b3
b6
b7C
b7D
b7E

Our information has been disseminated to [Redacted] State, military agencies, Customs, Secret Service and Department. By memorandum 7-16-65 it was recommended and approved that [Redacted]

(U)

[Redacted] In reply to Bureau request, Chicago advised it felt interviews with [Redacted] would not be advisable at this time since Chicago doubted any pertinent information would be obtained and since it would most likely cast immediate suspicion on its source. It is felt that Chicago should re-examine this matter and submit its comments as indicated above.

(U)

~~(S)~~

~~(S)~~

~~SECRET~~

FBI

Date: 7/14/65

Transmit the following

[Redacted]

(plaintext or code)

Via AIRTEL

[Redacted]

2-5-98 (Priority)

~~SECRET~~

b3
b6
b7C
b7E

TO : DIRECTOR, FBI [Redacted]

FROM : SAC, CHICAGO [Redacted]

10-23-64
Classified by
Declassify on: OADR (JFK)
DEC 55

SUBJECT: PLOT TO ASSASSINATE PREMIER FIDEL CASTRO DURING OCTOBER HOLIDAYS, 1965
ANTI-FIDEL CASTRO ACTIVITIES
IS - CUBA

Copy to: [Redacted] State/ [Redacted] by routing slip for info.
Date 7/19/65 by [Redacted]

The Bureau and recipient offices are requested to note the changed Chicago file number in this case. The previous number was [Redacted]

Re Bureau airtel to Chicago dated 7/8/65.

Enclosed for the Bureau are twelve copies, for Miami two copies and for Washington Field one copy of a letterhead memorandum dated and captioned as above.

The source mentioned in the letterhead memorandum is [Redacted]

Chicago is furnishing U.S. Secret Service locally a copy of the letterhead memorandum by FD-376.

Chicago has afforded [Redacted] no direction or control as to his current participation in the alleged plot. As noted

- 3 - Bureau (Encls. 12) (RM)
- 2 - Miami [Redacted] (Encls. 2) (RM)
- 1 - Washington Field (Encl. [Redacted]) (RM)
- 3 - Chicago

REC-55 105-145517-
EX-100

[Redacted]

b3
b6
b7C
b7E
UNRECORDED COPY FILED IN
b6
b7C
b7D

ALL INFORMATION CONTAINED HEREIN IS UNCLASSIFIED EXCEPT WHERE SHOWN OTHERWISE

Approved: [Signature]

Sent [Redacted] M

Per [Redacted]

b3
b6
b7C
b7E

51 AUG 18 1965

~~SECRET~~

by the Bureau there are the possibilities of violations

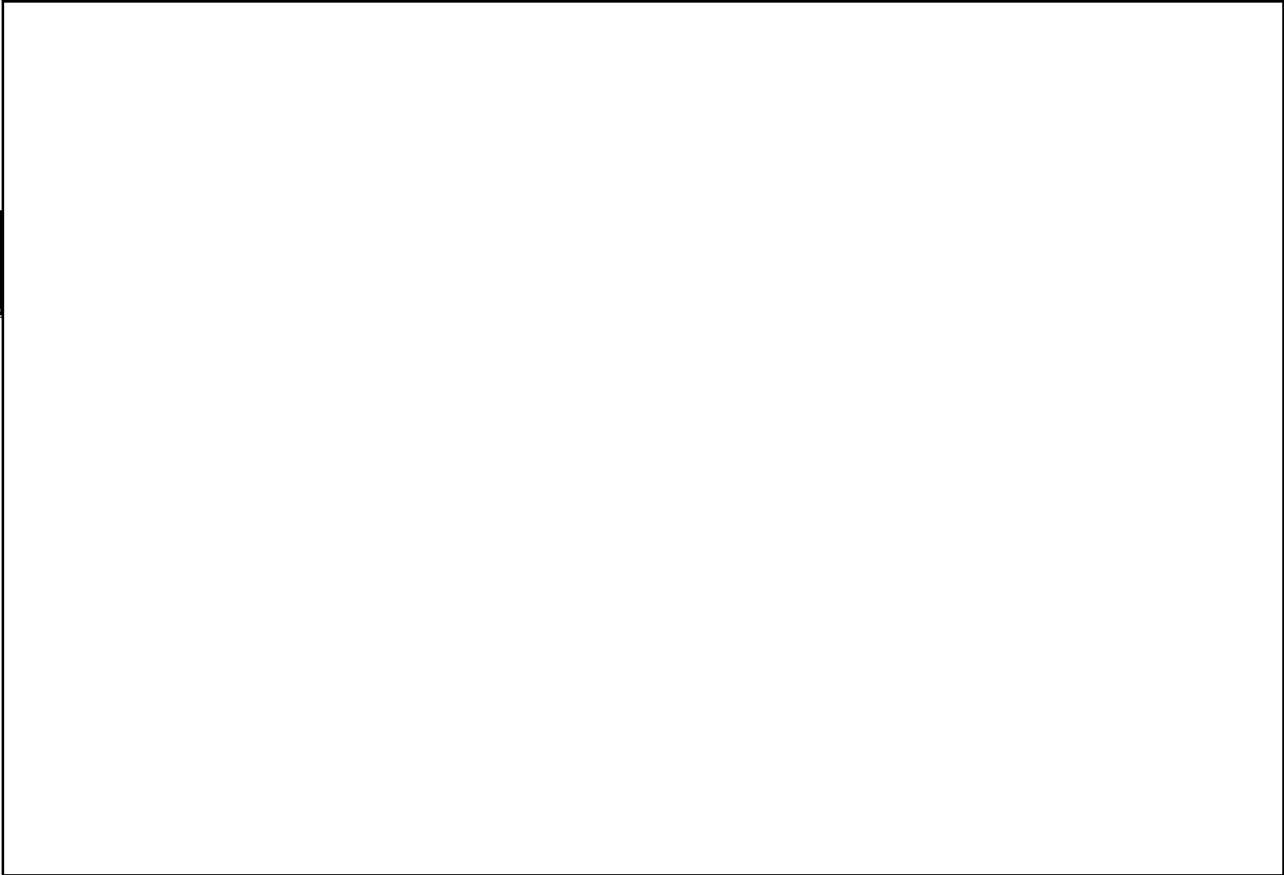

b3
b6
b7C
b7D
b7E

Chicago fully recognizes that we have an obligation to advise [redacted] of potential violations of the law at the point where it appears such potential violations exist. At this point, however, [redacted]

b6
b7C
b7D

[redacted]. It is felt that these possibilities should be quickly resolved prior to our concluding that violations are, in fact, in the making. Leads set out in this communication are pointed toward that purpose.

~~SECRET~~

~~SECRET~~

Responsive to the Bureau's request for Chicago's opinion concerning the interviews of [redacted]

[redacted] Chicago feels that interview at this time would not be advisable. It is doubtful that any information of value would be obtained and, in addition, would most likely cast immediate suspicion on [redacted] would be forced out of the picture and the Bureau would be without an immediate source privy to the details of the plot.

b6
b7C
b7D

Also, the Chicago Office has interviewed [redacted]

[redacted] The interview was conducted on 5/13/65 and results were furnished Miami.

b6
b7C

Chicago, in reviewing its files, has noted that [redacted] as reported by Miami to the Bureau by letter and letterhead memorandum dated 4/7/65 captioned [redacted]

b3
b6
b7C
b7D
b7E

[redacted] has advised the Bureau on 7/1/65, as reported in the above referenced Bureau airtel to Chicago [redacted]

[redacted]

It also might furnish a basis for interview of [redacted] which would not jeopardize [redacted]

[redacted]

Therefore, the Bureau is requested to recontact [redacted]

[redacted] separate and apart from that obtained by Chicago. The Miami Office is requested to do likewise [redacted]

b3
b6
b7C
b7E

In regard to the allegations reported in the attached letterhead memorandum that [redacted]

[redacted]

~~SECRET~~

CG 100-20239

~~SECRET~~

[REDACTED]
[REDACTED]
[REDACTED]
[REDACTED]

[REDACTED] In addition, the Bureau might give consideration to attempting to have [REDACTED] fully identified and his and the government's relationship with all of this determined.

b6
b7C
b7D

Chicago 10

Chicago will continue to maintain close contact with [REDACTED] and will remain alert to any other information concerning this plot and its participants.

b6
b7C
b7D

~~SECRET~~

~~SECRET~~



UNITED STATES DEPARTMENT OF JUSTICE
FEDERAL BUREAU OF INVESTIGATION

Chicago, Illinois
July 14, 1965

WASHINGTON, D. C. 20535

In Reply, Please Refer to
File No.

Chief
United States Secret Service
Department of the Treasury
Washington, D. C. 20220

ALL INFORMATION CONTAINED
HEREIN IS UNCLASSIFIED
DATE 10-23-94 BY [redacted]
(JFK)

b6
b7c

Dear Sir:

The information furnished herewith concerns an individual who is believed to be covered by the agreement between the FBI and Secret Service concerning Presidential protection, and to fall within the category or categories checked.

1. Has attempted or threatened bodily harm to any government official or employee, including foreign government officials residing in or planning an imminent visit to the U. S., because of his official status.
2. Has attempted or threatened to redress a grievance against any public official by other than legal means.
3. Because of background is potentially dangerous; or has been identified as member or participant in communist movement; or has been under active investigation as member of other group or organization inimical to U. S.
4. U. S. citizens or residents who defect from the U. S. to countries in the Soviet or Chinese Communist blocs and return.
5. Subversives, ultrarightists, racists and fascists who meet one or more of the following criteria:
 - (a) Evidence of emotional instability (including unstable residence and employment record) or irrational or suicidal behavior;
 - (b) Expressions of strong or violent anti-U. S. sentiment;
 - (c) Prior acts (including arrests or convictions) or conduct or statements indicating a propensity for violence and antipathy toward good order and government.
6. Individuals involved in illegal bombing or illegal bomb-making.

Photograph has been furnished enclosed is not available
 may be available through _____

Very truly yours,

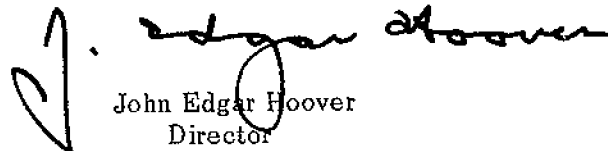
John Edgar Hoover
Director

1 - Special Agent in Charge (Enclosure(s) 1
U. S. Secret Service

Enclosure(s)

(Upon removal of classified enclosures, if any, this transmittal form becomes UNCLASSIFIED.)



UNITED STATES DEPARTMENT OF JUSTICE

FEDERAL BUREAU OF INVESTIGATION
Chicago, Illinois
July 14, 1965

In Reply, Please Refer to
File No.

ALL INFORMATION CONTAINED
HEREIN IS UNCLASSIFIED
DATE 10-23-94 BY [redacted]

b6
b7C

PLOT TO ASSASSINATE PREMIER FIDEL
CASTRO DURING OCTOBER HOLIDAYS, 1965

(OFF)

On July 13, 1965, a source, contact with whom has
been insufficient to determine reliability, advised as follows:

[Redacted]

b6
b7C
b7D

[Redacted]

b6
b7C
b7D

105-142517-7

1 ENCLOSURE

PLOT TO ASSASSINATE PREMIER FIDEL
CASTRO DURING OCTOBER HOLIDAYS, 1965



b6
b7C
b7D



b6
b7C
b7D

This document contains neither recommendations nor conclusions of the Federal Bureau of Investigation. It is the property of the Federal Bureau of Investigation and is loaned to your agency; it and its contents are not to be distributed outside your agency.

UNITED STATES GOVERNMENT

Memorandum

Tolson	_____
Belmont	_____
Mohr	_____
DeLoach	_____
Casper	_____ b6
Callahan	_____ b7C
Conrad	_____
Felt	_____
Gale	_____
Rosen	_____
Sullivan	_____
Tavel	_____
Trotter	_____
Tele. Room	_____
Holmes	_____
Gandy	_____

1 - Mr. Belmont
1 - Mr. Mohr

DATE: July 16, 1965

1 - Mr. DeLoach
1 - W. C. Sullivan

TO : Mr. W. C. Sullivan *MS*

FROM :

SUBJECT: PLOT TO ASSASSINATE PREMIER
FIDEL CASTRO DURING OCTOBER
HOLIDAYS, 1965
INTERNAL SECURITY - CUBA

ALL INFORMATION CONTAINED
HEREIN IS UNCLASSIFIED
DATE 10-23-94 BY [redacted]
(JFK)

b3
b6
b7C
b7D
b7E

My memorandum July 8, 1965, reported that [redacted]

[redacted] reportedly have [redacted]

[redacted] who is our source in this matter advised [redacted]

[redacted] have advised [redacted]

UNCLASSIFIED COPY FILED IN

b3
b6
b7C
b7D
b7E

In an effort to further identify [redacted] Office of Caribbean Affairs, Bureau of Inter-American Affairs, Department of State, was contacted by liaison on July 16, 1965. He advised name [redacted] meant nothing to him.

b6
b7C

The agencies which received our previous information namely [redacted] State, [redacted] Army, Navy, Air Force, [redacted] Customs, Co-ordinator for Cuban Affairs, Secret Service and Internal Security Division of the Department are being separately furnished the data provided by our source on July 13, 1965.

b3
b6
b7C
b7E

105-142517

CONTINUED - OVER

See X&D
AUG 10 1965

(7)

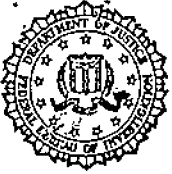

UNITED STATES DEPARTMENT OF JUSTICE

FEDERAL BUREAU OF INVESTIGATION
Chicago, Illinois

July 14, 1965

*In Reply, Please Refer to
File No.*

PLOT TO ASSASSINATE PREMIER FIDEL
CASTRO DURING OCTOBER HOLIDAYS, 1965

On July 13, 1965, a source, contact with whom has been insufficient to determine reliability, advised as follows:

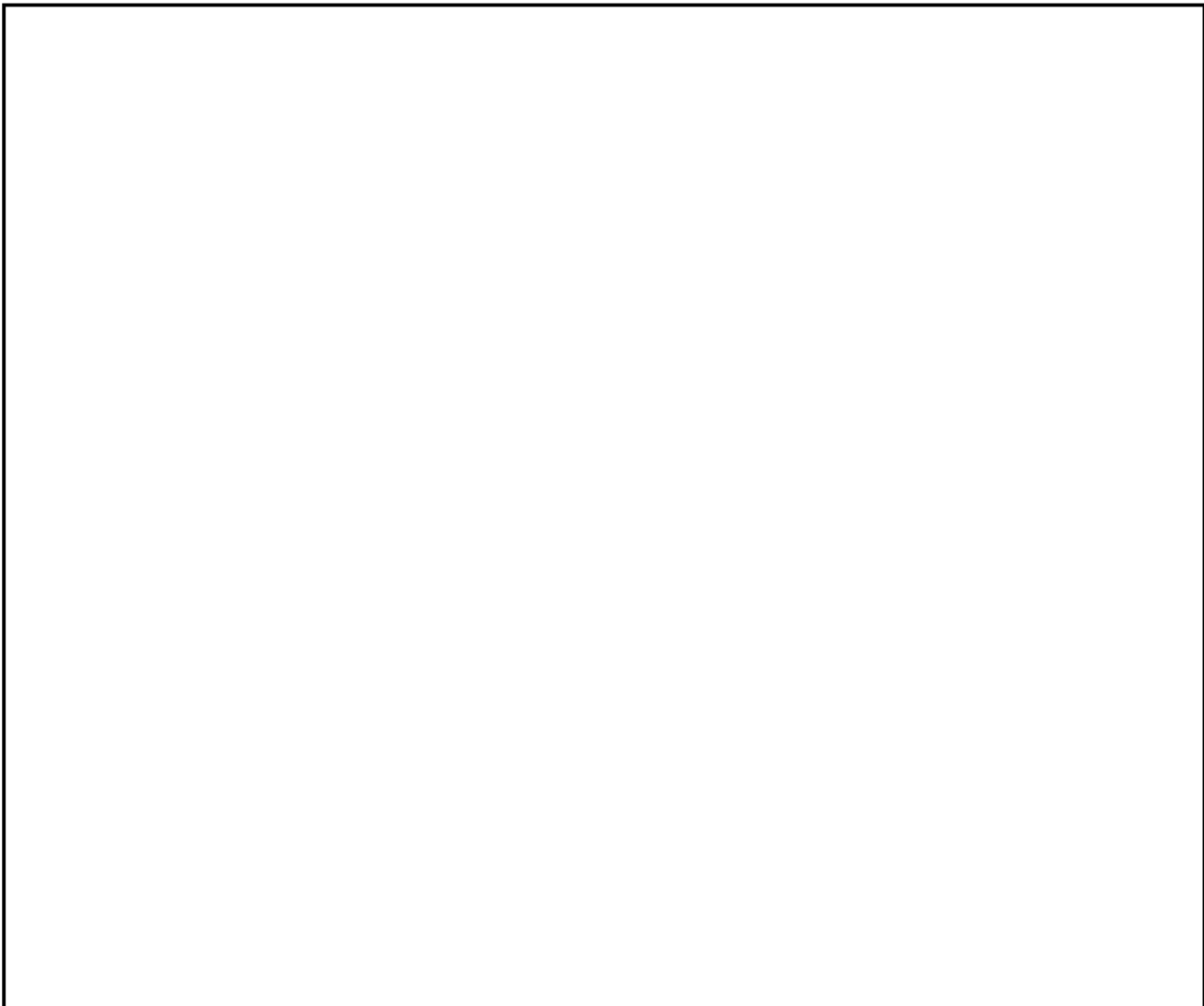

b6
b7C
b7D

PLOT TO ASSASSINATE PREMIER FIDEL
CASTRO DURING OCTOBER HOLIDAYS, 1965



b6
b7C
b7D

This document contains neither recommendations nor conclusions of the Federal Bureau of Investigation. It is the property of the Federal Bureau of Investigation and is loaned to your agency; it and its contents are not to be distributed outside your agency.

Memorandum [redacted] to Sullivan
PLOT TO ASSASSINATE PREMIER FIDEL CASTRO
DURING OCTOBER HOLIDAYS, 1965
105-142517

b6
b7C
b7D

OBSERVATIONS:

Since this may be scheme by [redacted]

[redacted]

In addition, it is felt discreet inquiry should be made of appropriate White House representative to determine if there has been recent presidential appointee named [redacted] and, if so, that he be contacted to determine if he has been approached by [redacted] as indicated.

ACTION:

If you approve, representative of Mr. DeLoach's office will contact Senator Dirksen or his representative and apprise him of the information we received and obtain from him any information which would have bearing in this matter.

If you approve, representative of Mr. DeLoach's office will discreetly contact appropriate White House representative to determine if there has been recent presidential appointee named [redacted] in the Latin-American field. If so, it should be determined from him whether he has been contacted by [redacted] as indicated.

b6
b7C

8/6/65

b3
b6
b7C
b7E

Airtel

[Redacted]

[Redacted] (JFK)

To: SAC, Chicago [Redacted]

From: Director, FBI (105-142517) - 9

ALL INFORMATION CONTAINED
HEREIN IS UNCLASSIFIED
DATE 10-23-91 BY [Redacted]

(JFK)

PLOT TO ASSASSINATE PREMIER FIDEL CASTRO
DURING OCTOBER HOLIDAYS, 1965
INTERNAL SECURITY - CUBA

b3
b7E

Reurairtel 7/14/65 with enclosure and Buairtel 8/3/65.

On 7/23/65, [Redacted]

to Senator Dirksen, recalled the name [Redacted] and upon searching his contact records ascertained that [Redacted] had telephoned the Senator's Office on 7/1/65 for an appointment. [Redacted] gave his Washington telephone number as NATIONAL 8-8510, Room 545. [Redacted] did not know if the Senator actually saw [Redacted]. For your information the Washington, D. C., Telephone Directory indicates that NATIONAL 8-8510 is the number for the Ambassador Hotel, 1412 K Street, Northwest.

b6
b7C

On 7/23/65 Senator Dirksen advised that he had no recollection of anyone named [Redacted] and felt certain that he had never talked to him.

b6
b7C

Inquiry was made of the appropriate White House officials on 7/27/65 and it was determined that the name of [Redacted] was unknown to them.

The foregoing is for confidential information of the recipients and must not be disseminated outside of the Bureau.

- 1 - Miami
- 1 - WFO
- 1 - [Redacted]

b3
b6
b7C
b7E

- Tolson _____
- Belmont _____
- Mohr _____
- DeLoach _____
- Casper _____
- Callahan _____
- Conrad _____
- Felt _____
- Gale _____
- Rosen _____
- Sullivan _____
- Tavel _____
- Trotter _____
- Tele. Room _____
- Holmes _____
- Gandy _____

(7)

RECORDED 5

1965

379

30 AUG 18 1965

31 AUG 12 1965

MAIL ROOM TELETYPE UNIT

SEE NOTE PAGE TWO

[Redacted]

UNRECORDED COPY FILED IN

Airtel to SAC, Chicago
PLOT TO ASSASSINATE PREMIER FIDEL CASTRO
DURING OCTOBER HOLIDAYS, 1965
105-142517

Chicago source furnished information concerning alleged plot to assassinate Castro in October, 1965. Reportedly, [redacted]

[redacted]
Our information has been disseminated to [redacted] State, military agencies, Customs, Secret Service and Department. By memorandum 7/16/65 it was recommended and approved that liaison contact Senator Dirksen or his representative [redacted]

[redacted]
[redacted] It was also recommended and approved liaison endeavor to identify [redacted] allegedly recent Presidential appointee, who was also allegedly contacted by [redacted]

b3
b6
b7C
b7D
b7E

UNITED STATES GOVERNMENT

Memorandum

Tolson	_____
Belmont	_____
Mohr	_____
DeLoach	_____
Casper	_____
Callahan	_____
Conrad	_____
Felt	_____
Gale	_____
Rosen	_____
Sullivan	_____
Tavel	_____
Trotter	_____
Tele. Room	_____
Holmes	_____
Gandy	_____

TO : Mr. DeLoach

DATE: 7-23-65

FROM :

[Redacted]

[Redacted]

SUBJECT: PLOT TO ASSASSINATE PREMIER FIDEL CASTRO
DURING OCTOBER HOLIDAYS, 1965
INTERNAL SECURITY - CUBA

Reference is made to memorandum dated 7-16-65, from [Redacted] to Mr. Sullivan, captioned as above, wherein it was recommended and approved that contact be made with Senator Dirksen's office to pass along information about

b6
b7C
b7D

[Redacted]

On July 23, 1965, SA [Redacted] contacted [Redacted] to Senator Dirksen and briefly outlined to him the information contained in referenced memorandum. [Redacted] recalled [Redacted] name and upon a search through his contact records ascertained that [Redacted] had telephoned the Senator's office on July 1, 1965, for an appointment. [Redacted] gave his Washington telephone number as NATIONAL 8-8510, Room 545. (The telephone directory shows NATIONAL 8-8510 is the number for the Ambassador Hotel, 1412 K Street, Northwest.) [Redacted] did not know if the Senator actually saw [Redacted]

b6
b7C

Senator Dirksen advised SA [Redacted] on July 23, 1965, that he has no recollection of anyone named [Redacted] and feels certain that he has never talked with the man.

b6
b7C

RECOMMENDATION:

For information.

[Handwritten note:] [Redacted] is unknown to the appropriate officials at the White House - [Redacted]

b6
b7C

- 1 - Mr. Belmont
- 1 - Mr. DeLoach
- 1 - Mr. Sullivan

[Redacted]
(7) [Redacted]

REC 25

105-142517-9

4 AUG 9 1965

105-142517

[Vertical handwritten notes:]
Sik...
1-MM
1-WFO

[Handwritten initials:] da

F B I

Date: 8/6/65

Transmit the following in _____
(Type in plaintext or code)

Via A I R T E L _____
(Priority)

TO : DIRECTOR, FBI (105-142517)
FROM : SAC, CHICAGO [redacted]
SUBJECT: PLOT TO ASSASSINATE PREMIER
FIDEL CASTRO DURING OCTOBER
HOLIDAYS, 1965
ANTI FIDEL CASTRO ACTIVITIES
IO - CUBA

REC-9

b3
b7E

Re Chicago airtel to Bureau dated 7/20/65, and Bureau airtel to Chicago dated 8/3/65.

On 8/6/65, [redacted] (Protect Requested),

b6
b7C
b7D

[redacted] advised that [redacted]

[redacted]

revised 11

Letterhead memorandum follows.

(3) - Bureau (RM)

[redacted]

REC-9 105-142511-10

EX 105

- 2 - Miami [redacted] (RM)
- 1 - Washington Field (Info.) (RM)
- 3 - Chicago

10 AUG 9 1965

b3
b6
b7C
b7E

[redacted]

(9)

NAT. INT. SEC.

UNRECORDED COPY FILED IN

Approved: _____ Sent _____ M Per _____

Special Agent in Charge

55 AUG 20 1965

For Informational Purposes Only

The originals removed from this file and replaced with duplicate copies of the original were accessioned to the National Archives and Records Administration (NARA) pursuant to the JFK Records Collection Act of 1992. Provision of the JFK Act allowed for certain information to be postponed from public release until the year 2017; therefore, the pages have NOT necessarily been released for public review in their entirety.

Under the JFK Act, originals to all material deemed assassination records must be accessioned to NARA regardless of whether the material is open in full or released with information postponed. Therefore, any documents or pages from FBI files accessioned to NARA pursuant to the JFK Act are no longer considered the possession of the FBI. The duplicate pages have been inserted strictly for research purposes.

The copies contained herein do not necessarily show the most up-to-date classification.

To attain a copy of the publicly released version of any materials maintained in the JFK Collection at the NARA facility in College Park, MD, you may contact the JFK Access Staff, at 301/713-6620.

The following materials were removed from this file and are maintained in the JFK Collection at NARA:

File & Serial Number

JFK Subject Identifier
(for NARA purposes)

105-142517-11

Church Committee

For Informational Purposes Only

5-143 (6-24-65)

DOMESTIC INTELLIGENCE DIVISION - FBI
LATIN-AMERICAN SECTION

_____, 1965

Mr. Belmont
Mr. Sullivan

[Redacted]

815 RB

Foreign Liaison
Mail Room, 5531
Translation Sec.

[Redacted]

RECORDS BRANCH
Consolidation Unit
Special Mail Room

[Redacted]

Send File b6
Bring File b7C
up to date
Place on Record
and Return

[Redacted] 7740

Post in File and
Destroy O-1 or
FD-205

Note File # and
Return R/S to
Room _____

Open-Close
Correct
Please Call Me
Please See Me

[Redacted]

b6
b7C

✓ [Redacted]

Room _____

[Large Redacted Block]

Treat as ~~Secret~~

ALL INFORMATION CONTAINED

HEREIN IS UNCLASSIFIED

DATE 10/8/85 BY _____

[Redacted]

b6
b7C

[Redacted]

Rm. 623 RB

F B I

Date: 8/17/65

Transmit the following in _____
(Type in plaintext or code)

Via AIRTEL _____
(Priority)

TO : DIRECTOR, FBI (105-142517)

FROM : SAC, CHICAGO [redacted]

SUBJECT: PLOT TO ASSASSINATE PREMIER
FIDEL CASTRO DURING OCTOBER
HOLIDAYS, 1965
IS - CUBA

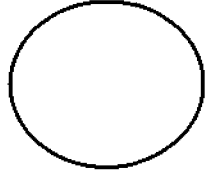

b3
b6
b7C
b7E

Re Bureau airtel to Chicago 8/16/65.

On 8/17/65, [redacted] (protect - requested),



b6
b7C
b7D

Miami interview [redacted] in accordance with instructions set forth by the Bureau in the above referenced airtel.

- ③ - Bureau (RM)
- 2 - Miami [redacted] (1-1)
- 3 - Chicago

REC-11

105-142517-24

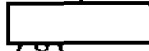
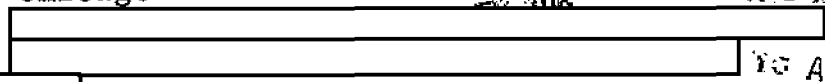

(8)

18 AUG 18 1965

b3
b6
b7C
b7E

Approved: [Signature]
Special Agent in Charge

Sent _____ M Per _____

53 AUG 17 1965

MAILED 11/17/65

CF

F B I

Date: 8/18/65

Transmit the following in _____
(Type in plaintext or code)

Via AIRTEL _____
(Priority)

TO : DIRECTOR, FBI (105-142517)
FROM : SAC, CHICAGO [redacted]
SUBJECT: PLOT TO ASSASSINATE PREMIER
FIDEL CASTRO DURING OCTOBER
HOLIDAYS 1965
IS - CUBA

b3
b7E

Re Bureau airtel to Chicago 8/16/65. Chicago airtel to Bureau 8/17/65.

On 8/18/65, [redacted] (protect - requested),

b6
b7C
b7D

[Large redacted area]

- 3 - Bureau (RM)
- 2 - Miami [redacted] (RM)
- 3 - Chicago

b3
b6
b7C
b7E

[redacted]

[redacted]
(8)

REC-21

105-142517 13

25 AUG 20 1965

NAT. INT. SEC.

[Redacted oval]

Approved: [Signature]
Special Agent in Charge

Sent _____ M Per _____

FBI

Date: 8/18/65

Transmit the following in _____
(Type in plaintext or code)

Via AIRTEL _____
(Priority)

TO: DIRECTOR, FBI (105-142517)
FROM: SAC, MIAMI [redacted] (P)
SUBJECT: PLOT TO ASSASSINATE
PREMIER FIDEL CASTRO
OCTOBER HOLIDAYS, 1965
IS - CUBA

b3
b6
b7C
b7E

Re Bureau airtel to Miami, 8/16/65, and
Chicago airtel to the Bureau, 8/11/65.

On 8/16/65 [redacted]
[redacted] advised [redacted]

b3
b6
b7C
b7E

[redacted]

[redacted] formed a private
company and, acting for this company and [redacted]
[redacted] sponsored a show in Chicago. They claim the
venture lost \$2,000. This was prior to 4/65, and since
that time these 2 persons have been in show business
and have not been active with [redacted]

b6
b7C

[redacted] said that they once mentioned a plot
to assassinate CASTRO [redacted]

b3
b6
b7C
b7E

[redacted] does not think
[redacted] have any serious intention in the

- 3-Bureau [redacted]
- 1-Chicago [redacted]
- 1-Miami [redacted]

REC-21 105-142517-14

3 AUG 20 1965

(5)

Approved: [Signature]
Special Agent in Charge

Sent _____ M Per _____

NAT. INT. SEC.

b3
b6
b7C
b7E

[redacted]

b3
b7E

future of an assassination attempt, or without U. S. Government backing.

[redacted]
[redacted] on 8/17/65, said [redacted]
leased the dining room at the hotel and put on a show nightly. They do not stay at the hotel, come there nightly, but their whereabouts during the day is unknown.

b6
b7C

Miami continuing efforts to locate and interview [redacted] and the Bureau will be advised.

b6
b7C

9/22/65

For Informational Purposes Only

The originals removed from this file and replaced with duplicate copies of the original were accessioned to the National Archives and Records Administration (NARA) pursuant to the JFK Records Collection Act of 1992. Provision of the JFK Act allowed for certain information to be postponed from public release until the year 2017; therefore, the pages have NOT necessarily been released for public review in their entirety.

Under the JFK Act, originals to all material deemed assassination records must be accessioned to NARA regardless of whether the material is open in full or released with information postponed. Therefore, any documents or pages from FBI files accessioned to NARA pursuant to the JFK Act are no longer considered the possession of the FBI. The duplicate pages have been inserted strictly for research purposes.

The copies contained herein do not necessarily show the most up-to-date classification.

To attain a copy of the publicly released version of any materials maintained in the JFK Collection at the NARA facility in College Park, MD, you may contact the JFK Access Staff, at 301/713-6620.

The following materials were removed from this file and are maintained in the JFK Collection at NARA:

File & Serial Number

JFK Subject Identifier

(for NARA purposes)

105-142517-15

Church Committee

For Informational Purposes Only

UNITED STATES GOVERNMENT

Memorandum

TO : DIRECTOR, FBI (105-142517)

DATE: 9/22/65

b3
b6
b7C
b7E

FROM : SAC, CHICAGO [redacted]

SUBJECT: PLOT TO ASSASSINATE PREMIER
FIDEL CASTRO DURING OCTOBER
HOLIDAYS, 1965
IS-CUBA

Re Miami letter to the Bureau dated 8/24/65 and attached letterhead memorandum of same date.

Chicago, via courier, has delivered one copy of the above referenced letterhead memorandum to United States Secret Service, Chicago, Illinois.

A review of the total investigation to date concerning the alleged plot to assassinate Premier FIDEL CASTRO and especially the results of the interviews conducted by Miami draws a conclusion as follows: That [redacted]

[redacted] are conducting a confidence game. They are playing on the legitimate desires of the Cuban Community and the sympathies of United States citizens to see FIDEL CASTRO and his government in Cuba overthrown. Evidently they have concocted a scheme which is plausible and simple and can be used to extract money from gullible individuals. The business activities of [redacted] indicate that they are operators; although there may have been thoughts of killing CASTRO, it appears more that they were using their plans to obtain funds possibly to aid them in getting their business established and functioning or to keep it out of debt.

b6
b7C

- ② - Bureau (RM)
- 1 - Miami [redacted] (RM)
- 3 - Chicago

b3
b6
b7C
b7E

55 OCT 1 1965

REC-61

EX-113

SEP 24 1965

NAT. INT. SEC.

105-142517-116

[redacted]

b3
b6
b7C
b7D
b7E

On September 15, 1965, [redacted]
(protect requested), [redacted]
advised that [redacted]
[redacted]

Since the principal participants in this plot have all been interviewed and since no corroborating information has been developed by other investigation, it is the opinion of Chicago that at best this plot is a dream or hope by [redacted] and is being used for nothing more than the obtaining of money from sympathetic contributors.

b6
b7C

Chicago will maintain close contact with [redacted] the original source of information in this matter and [redacted] concerning any further information which may come to their knowledge concerning the participants and/or the plot.

b6
b7C
b7D

Chicago is placing this case in a closed status at this time because of the return of [redacted] in the Chicago area, but will remain alert to any future developments and will promptly report any future information received.

b6
b7C

For Informational Purposes Only

The originals removed from this file and replaced with duplicate copies of the original were accessioned to the National Archives and Records Administration (NARA) pursuant to the JFK Records Collection Act of 1992. Provision of the JFK Act allowed for certain information to be postponed from public release until the year 2017; therefore, the pages have NOT necessarily been released for public review in their entirety.

Under the JFK Act, originals to all material deemed assassination records must be accesssioned to NARA regardless of whether the material is open in full or released with information postponed. Therefore, any documents or pages from FBI files accessioned to NARA pursuant to the JFK Act are no longer considered the possession of the FBI. The duplicate pages have been inserted strictly for research purposes.

The copies contained herein do not necessarily show the most up-to-date classification.

To attain a copy of the publicly released version of any materials maintained in the JFK Collection at the NARA facility in College Park, MD, you may contact the JFK Access Staff, at 301/713-6620.

The following materials were removed from this file and are maintained in the JFK Collection at NARA:

File & Serial Number

JFK Subject Identifier
(for NARA purposes)

105-142517-17

CARLOS RODRIGUEZ
QUESADA

For Informational Purposes Only

~~CLASSIFIED BY [redacted] FOREIGN 11/15/65~~
~~DECLASSIFY ON: 25X [redacted]~~

AIRTEL *(SFA)* REGISTERED MAIL

TO: DIRECTOR, FBI [redacted]
FROM: SAC, MIAMI [redacted] (P)

*para 2, 4
classified per*
[redacted] b3
b6
b7C
b7E
3/11/83

ANTI-FIDEL CASTRO ACTIVITIES
(ALLEGED PLANS TO ASSASSINATE FIDEL CASTRO)

1082 CASTRO

Enclosed herewith are 12 copies of LHM dated and captioned as above.

Copies furnished locally to ONI, OSI, G-2, Coordinator of Cuban Affairs, Department of State [redacted], Coast Guard, Customs, Miami, Customs, Region II, Miami, Customs, Key West, Border Patrol, and INS *(4/14)*

LHM classified ~~CONFIDENTIAL~~, inasmuch as it contains information so classified by [redacted]

MM T-1 is [redacted]
[redacted]

It is noted the majority of the Cuban refugees arriving in the U. S. from Cuba, particularly during the current mass exodus, have stated that in their opinion,

- 3 - Bureau (Enc. 12) (RM)
- 1 - Miami
- 1 - New York (info) (RM) (Enc. 1)
- 1 - San Juan (info) (RM) (Enc. 1)
- 1 - Chicago (info) (RM) (Enc. 1)

(7)

Class. & Ext. BY [redacted] *6/07/82*
Reason-FCIM II, 1-2.4.2, 2
Date of Review *11/15/85*
62, 472

ENCLOSURE
138
100-10-1005

105-142517-
NOT RECORDED
150 NOV 19 1965

~~SECRET~~

ALL INFORMATION CONTAINED
HEREIN IS UNCLASSIFIED EXCEPT
WHERE SHOWN OTHERWISE.

ORIGINAL FILED

b3
b6
b7C
b7E

b3
b6
b7C
b7E

[redacted]

~~SECRET~~

~~CONFIDENTIAL~~

b3
b7E

they believe the best and most expeditious means of ridding Cuba of Communism is to overthrow FIDEL CASTRO. In this regard, they have stated the assassination of FIDEL CASTRO and [redacted] would probably be the most expeditious way to overthrow the Government of Cuba, especially since ERNESTO "CHE" GUEVARA, former top official of the Government of Cuba, is no longer connected with that regime. They further stated that both FIDEL [redacted] CASTRO are heavily guarded, and believe the assassination of these men would be extremely difficult, if not impossible, unless given the support and assistance of another government, not necessarily the U. S. Government.

b6
b7C

It is also noted this investigation was opened by the Chicago Office in 6/65 when the complainant was referred to the FBI by [redacted] in Chicago. Subsequent investigation by the FBI developed [redacted]

b3
b6
b7C
b7E

[redacted]

As noted in the enclosed LHM, interview of [redacted] reflect the matter is merely talk and wishful thinking on their part. Investigation of associates and informants tends to confirm the alleged plot was merely idle conversation. It is also noted [redacted]

b3
b6
b7C
b7E

[redacted]

Confidential informants contacted negatively for any information regarding any alleged plans to assassinate FIDEL CASTRO were:

[redacted] by SA [redacted] [initials]

b6
b7C
b7D

~~SECRET~~

~~CONFIDENTIAL~~

[Redacted]

~~SECRET~~

~~CONFIDENTIAL~~

b3
b6
b7C
b7D
b7E

[Redacted]

by SA
by SA
by SA
by SA

[Redacted]

~~(U)~~

~~CONFIDENTIAL~~

~~SECRET~~
3.

~~SECRET~~



UNITED STATES DEPARTMENT OF JUSTICE
FEDERAL BUREAU OF INVESTIGATION

In Reply, Please Refer to
File No.

b3
b6
b7C
b7E

[Redacted]

~~CONFIDENTIAL~~
6/14/82

Miami, Florida
November 15, 1965

Class. & Ext. By
Reason-FCIM II, 1-2.4.2
Date of Review 11/15/82

DECLASSIFIED BY
ON 1/28/94

[Redacted]

62-472

~~CONFIDENTIAL~~

(JFK)

Re: ANTI-FIDEL CASTRO ACTIVITIES
(ALLEGED PLANS TO ASSASSINATE
FIDEL CASTRO)

[Redacted]

ALL INFORMATION CONTAINED
HEREIN IS UNCLASSIFIED
DATE 5/26/98 BY [Redacted]

(JFK)

This investigation was predicated on information
received from MM T-1, [Redacted]

[Redacted]

(JFK) u

On August 11, 1965, MM T-1 reported [Redacted]

b3
b6
b7C
b7E

[Large Redacted Block]

According to the report of MM T-1, [Redacted]

[Large Redacted Block]

b3
b6
b7C
b7E

(JFK) u

ALL INFORMATION CONTAINED
HEREIN IS UNCLASSIFIED EXCEPT
WHERE SHOWN OTHERWISE.

~~CONFIDENTIAL~~

~~CONFIDENTIAL~~

Group 1
Excluded from automatic
downgrading and
declassification

105-143517 -
ENCLOSURE

~~CONFIDENTIAL~~

Re: ANTI-FIDEL CASTRO ACTIVITIES
(ALLEGED PLANS TO ASSASSINATE FIDEL CASTRO)

~~CONFIDENTIAL~~

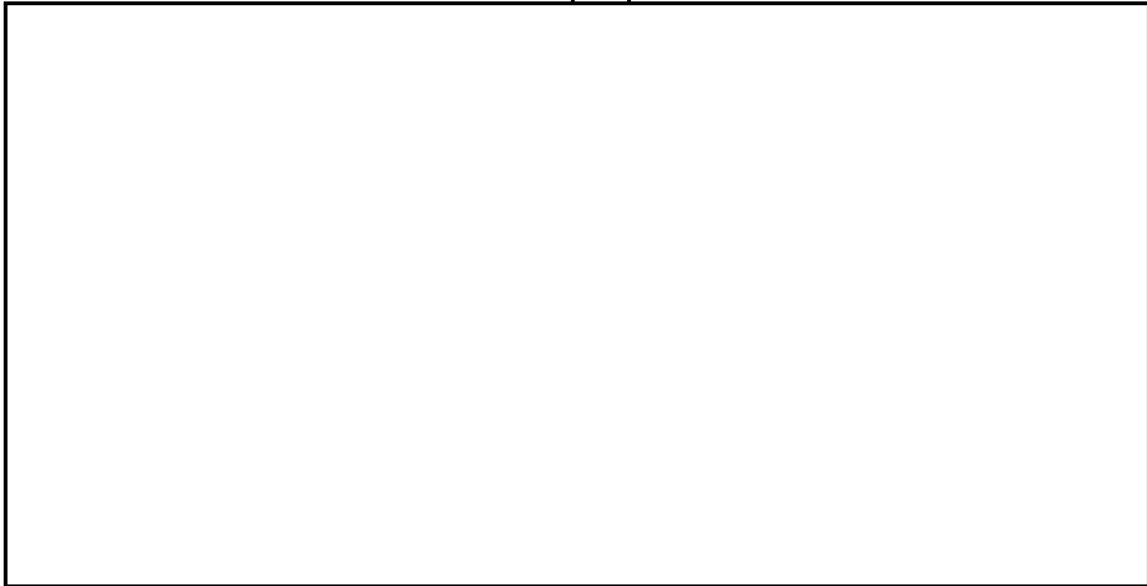

b3
b6
b7C
b7E

MM T-1 reported on

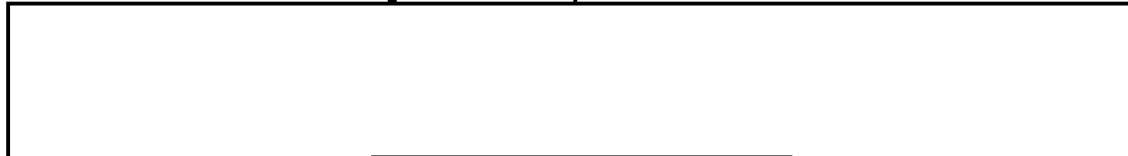

However,



according to MM T-1,

b3
b6
b7C
b7E



 (S)

~~CONFIDENTIAL~~

~~CONFIDENTIAL~~

~~CONFIDENTIAL~~

Re: ANTI-FIDEL CASTRO ACTIVITIES
(ALLEGED PLANS TO ASSASSINATE FIDEL CASTRO)

~~CONFIDENTIAL~~

According to MM T-1, [redacted]

[redacted]

b3
b6
b7C
b7E

By report [redacted]

MM T-1

[redacted]

b3
b6
b7C
b7E

According to the source, [redacted]

[redacted]

b3
b6
b7C
b7E

[redacted] according to the source,

[redacted]

[redacted]

~~CONFIDENTIAL~~

3.
~~CONFIDENTIAL~~

~~CONFIDENTIAL~~

Re: ANTI-FIDEL CASTRO ACTIVITIES
(ALLEGED PLANS TO ASSASSINATE FIDEL CASTRO)

~~CONFIDENTIAL~~

[Redacted]

(S) 4

b3
b6
b7C
b7E

[Redacted]

[Redacted]

7/2/4

~~CONFIDENTIAL~~
4.

~~CONFIDENTIAL~~

FEDERAL BUREAU OF INVESTIGATION

~~CONFIDENTIAL~~

~~CONFIDENTIAL~~

Date November 12, 1965

On November 9, 1965, [redacted]

b6
b7C

[redacted] telephone [redacted] was advised he did not have to make any statements, that any statements made by him could be used against him in a court of law, and that he had the right to consult an attorney of his own choice before making any statements. He voluntarily furnished the following information:

He was born [redacted] where he lived and graduated from high school. He was in the United States from approximately April 7, 1955, until 1959, during which time he worked for the Schrafft Restaurant and Arnesto Paint Company, both New York City. While in New York, he was an active member of the 26th of July Revolutionary Movement of FIDEL CASTRO and during 1959, he was [redacted] the Cuban Agrarian Reform Committee, New York City. He returned to Cuba around September, 1959, where he remained until approximately June, 1962. While in Cuba, he was [redacted]

b6
b7C

[redacted] He was never in the militia. He became disillusioned with the 26th of July Revolutionary Movement and decided to fight against the FIDEL CASTRO government. He attempted to secure arms and ammunition and convinced the people in Camaguey, particularly the students, that they should fight against CASTRO because he had not lived up to his promise in the revolution. He explained this by indicating that in a conversation with HUBERT MATOS, former comandante of the Cuban Revolutionary Army in Camaguey, currently serving sentence in the Isle of Pines, Cuba, for counterrevolutionary activities, MATOS had informed him CASTRO was supporting the communist cause.

Around June, 1960, he became associated with the action and sabotage group of the Movimiento Revolucionario del Pueblo (MRP) (Revolutionary Movement of the People). He was responsible for organizing the farmers in the province of Camaguey. Later he became [redacted]

b6
b7C

[redacted] and around December, 1961, he [redacted]

5
~~CONFIDENTIAL~~

On 11/9/65 at Miami, Florida

File # [redacted]

b3
b6
b7C
b7E

SAs [redacted]

by [redacted] Date dictated 11/10/65

~~CONFIDENTIAL~~

[redacted]

2

~~CONFIDENTIAL~~ CONFIDENTIAL

went to Havana, [redacted]

[redacted] He remained in Havana until approximately June, 1962. From June, 1962, until around January, 1963, he traveled throughout the island of Cuba [redacted] and engaged in counterrevolutionary activities. Around January, 1963, [redacted]

[redacted] where he remained until June 17, 1963, at which time he left Havana and arrived in Miami, Florida, in exile. Upon his arrival in Miami, he attempted to become associated with the MRP. However, because of the disunity among the Cuban exiles in Miami, he actually never belonged to any organization. He stated a group of friends, including [redacted]

b6
b7C

[redacted] both former members of the MRP, had become somewhat dissatisfied with the MRP and its inability to achieve unity among the Cuban exiles.

[redacted] stated that he had solicited some money in order to help members of the family of former members of the MRP who had been executed, such as [redacted] but that he had never collected any money for anti-FIDEL CASTRO activities as such. Since his arrival in Miami in 1963, he has remained here with the exception of one brief trip to New York City shortly after his arrival. He stated he was not acquainted with [redacted]

b6
b7C

[redacted]

[redacted] formerly of Alpha 66 and 30th of November Movement, respectively, both anti-FIDEL CASTRO organizations. He was unable to recall the name of any individual who had formerly been a captain in the Cuban Revolutionary Army who might have arrived in Miami in or around June, 1965.

In addition, he stated he did not have any particular contacts in Cuba or in the United States with anyone in a position to make an assassination attempt.

He advised he was acquainted with [redacted]

b6
b7C

[redacted] currently residing in [redacted]

[redacted] He has not seen or heard from him in approximately one year.

~~CONFIDENTIAL~~

X

[Redacted]

~~CONFIDENTIAL~~ ~~CONFIDENTIAL~~

3

b3
b6
b7C
b7E

The following is a description of [Redacted] obtained from observation and interview:

Name

[Large empty rectangular box for description details]

Date of birth
Place of birth
Race
Sex
Height
Weight
Hair
Eyes
Marital status
Wife

b6
b7C

Father
Mother
Employment

~~CONFIDENTIAL~~

7.

~~CONFIDENTIAL~~

FEDERAL BUREAU OF INVESTIGATION

1

~~CONFIDENTIAL~~

~~CONFIDENTIAL~~

Date November 10, 1965

On November 4, 1965, [redacted]

[redacted] telephone [redacted], was advised he did not have to make any statement, that any statements made by him could be used against him in a court of law, and that he had the right to consult an attorney of his own choice before making any statements, after which he voluntarily furnished the following information:

b6
b7C

He was born [redacted] received his basic education in Camaguey, and during the period 1959-60, he attended the University of Havana, where he studied agricultural engineering. While in attendance at the University, he joined the Movimiento Revolucionario del Pueblo (MRP) (Revolutionary Movement of the People). He claimed he had not been an active member of the 26th of July revolutionary movement of FIDEL CASTRO; however, he had been opposed to the regime of FULGENCIO BATISTA. In 1960, after joining the MRP, he returned to Camaguey, Cuba, where he was a member of the action and sabotage group of the MRP. His main duties were to solicit student support and, in general, he was organizing the Province of Camaguey under the auspices of the MRP.

b6
b7C

Around September, 1961, he went to Havana, Cuba, [redacted] where he remained in such capacity until approximately December 10, 1962. At this time, [redacted] and subsequently departed Cuba for Puerto Rico January 6, 1963. Up until this time, he had never met [redacted]

b6
b7C

[redacted] He remained in Puerto Rico for about five days and then came to Miami, Florida. Since his arrival in Miami, he has worked for the Catholic Welfare Bureau in South Miami, Florida Fiberglass Company, manufacturer of boats, and 7/11 grocery stores, all in Miami.

8

~~CONFIDENTIAL~~

11/4/65

Miami, Florida

On _____ at _____

File # [redacted]

SA [redacted]

by _____

~~CONFIDENTIAL~~

Date dictated

11/10/65

b3
b6
b7C
b7E

~~CONFIDENTIAL~~
~~CONFIDENTIAL~~

b3
b6
b7C
b7E

While in Cuba, [redacted] worked closely with one [redacted]

[redacted] However, [redacted] indicated he has not seen or been in contact with him for more than two years.

b6
b7C

[redacted] advised he went to Caracas, Venezuela, for approximately fifteen days in order to arrange for enrollment at the Andres Bello University, a Catholic institution in Caracas. He believed this travel was made in August, 1965. He stated these plans had been changed or temporarily delayed because of the recent "exodus program" in which FIDEL CASTRO has reportedly agreed to permit Cubans desiring to leave Cuba to come to the United States. He related his parents' farm in Camaguey had been confiscated by the communist Cuban government and he was currently awaiting the arrival of his parents in Miami. After his parents arrive, he will then make a decision as to whether or not he will continue his education in Venezuela. He stated the only things which he brought back to the United States from Venezuela were two books on sociology which he planned to study at the Andres Bello University.

[redacted] stated he was acquainted with ARNALDO SCHWERERT, a Cuban approximately fifty years of age, now in Caracas, Venezuela. At the time of his visit to Caracas, he met with SCHWERERT, who was an executive officer in the Chamber of Commerce in Caracas. He denied SCHWERERT had given him money or anything else. He stated SCHWERERT had been active in the MRP in Cuba but did not believe he was active in any Cuban revolutionary activities at present.

b6
b7C

[redacted] denied that he had been active in any anti-FIDEL CASTRO activities since his arrival in Miami. He stated he had not solicited any funds or made any collections of money for boats, arms, ammunition, etc. He denied he had any contact with [redacted]

b6
b7C

[redacted] related that he believed one of the best ways in which to rid Cuba of communism was to overthrow or assassinate FIDEL CASTRO. He indicated that he had discussed this many times, as have most Cubans in exile. One plan that he believed might have been feasible during the sugar cane harvest season was to kill CASTRO during one of

~~CONFIDENTIAL~~

~~CONFIDENTIAL~~

[Redacted]

~~CONFIDENTIAL~~

~~CONFIDENTIAL~~

b3
b7E

his numerous visits to the sugar cane fields. He noted that CASTRO in the past has frequented the sugar cane fields during the harvest season, which is around August and September.

[Redacted] further denied knowing the following individuals:

b6
b7C

[Redacted]

[Redacted] advised he was acquainted with both [Redacted] and [Redacted] formerly of Alpha 66 and 30th of November Movement, respectively, both anti-FIDEL CASTRO organizations. He was unable to recall the name of any individual who had formerly been a captain in the Cuban Revolutionary Army who might have arrived in Miami in or around June, 1965.

b6
b7C

In addition, he stated he did not have any particular contacts in Cuba or in the United States with anyone in a position to make an assassination attempt.

The following is a description of [Redacted] obtained through observation and interview:

- Name
- Race
- Sex
- Date of birth
- Height
- Weight
- Hair
- Eyes

- Marital status
- Father
- Mother
- Sisters
- Brother

[Redacted]

b6
b7C

~~CONFIDENTIAL~~

~~CONFIDENTIAL~~

~~CONFIDENTIAL~~

Re: ANTI-FIDEL CASTRO ACTIVITIES
(ALLEGED PLANS TO ASSASSINATE FIDEL CASTRO)

~~CONFIDENTIAL~~

On November 4, 1965, [redacted] Cuban exile, Miami, and formerly a member of the MRP, advised he was unable to offer any information concerning any alleged plans to possibly assassinate FIDEL CASTRO. He stated that he has heard many Cuban exiles express their desire to assassinate CASTRO, and believed this would be the best way in which Cuba could be rid of Communism. He readily explained, however, that many Cubans, as well as the Russians, would blame the United States for this should it occur, and for this reason, he did not believe in any such alleged plan. He further indicated that he was acquainted with [redacted] formerly members of the MRP, and they, too, had mentioned that possibly during the harvest season for sugar cane would be time when FIDEL CASTRO would visit in the fields and someone could attempt to assassinate him. He continued, however, that this was merely "a dream and hallucination" of these two individuals.

b6
b7C

He also explained that Cubans in exile talk very freely, and make plans one day which they do not believe will ever materialize. [redacted] continued that both [redacted] [redacted] have collected small sums of money, to his knowledge, to give to members of families who are currently in Cuba. He did not believe they had collected over \$1,000.00 altogether.

b6
b7C

Sources and informants familiar with both pro- and anti-FIDEL CASTRO activities in Cuba and the United States were contacted, and each advised he was unable to furnish any information regarding any alleged plans to assassinate CASTRO, which he felt might materialize. None had any specific information indicating [redacted] were currently active in any Cuban political or revolutionary activities.

b6
b7C

PROPERTY OF FBI - This document contains neither recommendations nor conclusions of the FBI. It is the property of the FBI and is loaned to your agency; it and its contents are not to be distributed outside your agency.

~~CONFIDENTIAL~~

11.*

~~CONFIDENTIAL~~

Fidel Castro: Pro and Con

In connection with the anti-Castro propaganda that has been spread in Washington by a certain Rafael del Pino, I feel that it is in the best interest in Cuban-American relations to present the true facts in this case.

Mr. del Pino lacks the authority to address the American public. His poor record is objectively reported in the recently published biography of Fidel Castro by Jules Dubois, Latin American correspondent for the Chicago Tribune.

This person lacks any support of public opinion in Cuba. His insinuations in his attempt to portray Fidel Castro as an agent of international communism are as completely false as is his status of "revolutionary."

Fidel Castro has given back to the Cuban people the democratic liberties that during seven years were suppressed by the Batista dictatorship. In a few days Dr. Castro will have the opportunity of presenting to the American public the high ideals of the programs being developed by the revolutionary government and that are supported by 90 per cent of the Cuban people as revealed by recent public opinion polls in Cuba.

These goals include:

1. Unequivocal rights for all citizens as defined in the Cuban constitution.
2. Alleviation of the great poverty which afflicts a great number of the Cuban people through a plan of land reform, development of new industries, encouragement of private investments, and protective laws which will impede exploitation of the poorer classes.

The policies of the revolutionary government of Fidel Castro with their democratic principles and immediate aims of raising the standard of living throughout the whole country is the most vigorous of safeguards against Communist infiltration.

RAUL ROA
Ambassador of Cuba to the Organization of American States, Washington.

Although this organization no longer represents the Re-

public of Cuba nor has any official connection with the Batista regime exiles, we would feel it an act against our conscience if we did not enter a protest against the invitation extended to Fidel Castro to address the meeting of the American Society of Newspaper Editors.

Since his occupation of Havana, Castro has followed a rigid anti-American policy. He has attacked the United States in every possible manner, clearly demonstrating his preference for the Moscow line. In recent weeks he has virtually banned the sale of American products in Cuba, products whose advertising accounts help materially to maintain the American newspaper industry.

His actions in imposing a censorship of terror over the press, radio and television and his treatment of newspapermen who were not identified with the revolution is directly contrary to the American ideal of a free press.

His philosophy on the holding of private property, inheritance, collection of rents and his virtual prohibition of functioning of the professional classes on an equitable profit basis is in direct opposition to the capitalist system on which our country is founded.

His avowed intention to foment invasion and armed disorder in the Dominican Republic, Nicaragua and Panama is a threat to the peace and security of the hemisphere.

He has established the death penalty for all offenses defined as counter revolutionary and has permitted Raul Castro to include as part of the definition of such activities the following: "To fight against communism is divisionism and divisionism is counter-revolutionary."

For these and other reasons perfectly obvious it is our belief that the invitation to Fidel Castro by the ASNE is an insult to the American people.

JOHN B. KEEFER
President, University Research and Consultants, Inc.
Washington.

SEARCHED	INDEXED
SERIALIZED	FILED
APR 14 1959	

b3
b6
b7C
b7E

A b

Bonsal Told Cuba Will Back U. S. If War Comes

By HENRY BAYMONT
Cuba has assured the United States it will remain firmly in the Western camp in event of war with the Soviet Union, diplomatic sources disclosed today.

The assurances were given to Philip Bonsal, new United States Ambassador to Cuba, in a series of informal conversations with high Cuban officials, the sources said.

In effect, the officials were reported to have discounted Prime Minister Fidel Castro's

remark that Cuba would be neutral in a United States-Russian conflict. They said his remark was merely an impulsive reaction to recent criticism of his policies.

Mr. Bonsal and the State Department were also told that Castro would make a determined effort to dispel the apprehension caused by his remarks when he makes an unofficial visit to the United States this week.

The Cuban premier is expected to reiterate his country's allegiance to the Inter-American defense system based on the principle that an attack on one American nation is an attack on all.

Informants who spoke with Castro earlier said he would emphasize that United States aid to the former government of Fulgencio Batista would not mar the traditional friendship between the two countries.

Castro also will stress the need for greater understanding when he addresses the annual meeting of the American Society of Newspaper Editors Friday and at a National Press Club luncheon April 20, the sources said. (UPI)

[Redacted]

SEARCHED [] INDEXED []
SERIALIZED [] FILED []

APR 13 1959

[Redacted]

b3
b6
b7C
b7E

SOUTH AMERICA WANDERINGS

Castro's Emissaries Getting Cool Reception

By EDWARD TOMLINSON

Written for Scripps-Howard Newspapers

(See Evelyn Peyton Gordon on Page 24)

BUENOS AIRES, April 13—Premier Fidel Castro's good-will drummers are getting no such welcome carpets in South America as appears likely for Castro himself on his trip this week to the United States.

For several weeks the Castro representatives have been wandering around this continent in their familiar khaki fatigues, with collars open, whiskers aflutter and cigars aflame.

They have received no ovations, and had no curtain calls, not even in the most "democratic" of the countries, such as Chile and Uruguay. Except for the communist newspapers and the flaming leftist sheets, the press has accorded the revolutionaries comparatively little space.

CHILE REACTION

In Chile, the Foreign Minister, rather than the President, received them briefly. Several newspapers had sharp editorial comments on the war criminal trials in Havana.

When the Fidelistas showed up in one of Santiago's smart restaurants, a nearby group of diners jeered: "Send for the barbers' union." At this, one of the Cubans whipped out a pistol, and it took considerable mollifying to get him off the premises without incident.

In Uruguay, a semi-socialist state, they expected an enthusiastic reception. But again, except for the Reds, they got a cold shoulder. At a press reception, one reporter asked: "Why all the executions after the revolution was won?" Spokesman for the Cuban group replied: "For the same reason, the allies executed German war criminals after the Axis powers surrendered."

WALKOUT

Then the reporters from communist newspapers tried

to channel the press conference into a forum against Yankee "imperialism." But other newsmen walked out.

Here in Buenos Aires, the communists once more attempted to run interference for the Cubans. Naturally the Peronistas gave them no time. The leading newspapers were polite. As the Cubans strolled the capital's most fashionable street, few people turned to look at them, tho the average Buenos Aires resident would consider himself virtually naked without a collar and tie.

SEARCHED	INDEXED
SERIALIZED	FILED
APR 1 1955	
FBI WASHINGTON	

Restore Rights, Cubans Appeal

HAVANA, April 13 (AP) — Cuba's Rotarians are appealing for the restoration of habeas corpus and speedy trials for hundreds of civilian prisoners held by Fidel Castro's government.

Meeting in Santa Clara during the weekend, the Rotarians said conditions in Cuba have returned to normal and habeas corpus — which prevents police from holding prisoners for long periods without formal charges — should be reestablished as a universally recognized human right.

SEARCHED	INDEXED
SERIALIZED	FILED

b3
b6
b7C
b7E

Castro Turns Down Cuban Vote Plea

HAVANA, April 13 (AP)—Premier Fidel Castro, in a speech in Camaguey, last night, rebuffed suggestions that elections be held soon in Cuba.

He told a cheering crowd that "the people want the revolution to finish its program first and hold elections afterward."

His references to elections were interrupted frequently by shouts of "Elections, not elections, no!"

Former President Ramon Grau San Martin in a statement Saturday urged that elections be held as the best way to build confidence and fight unemployment and other problems.

guardsman and fled. Authorities estimated six or eight men were all that remain of the rebel band operating in northwest Panama.

SEARCHED... INDEXED...
SERIALIZED... FILED...
APR 14 1959

b3
b6
b7C
b7E

Rep. Davis Hits Editors for Castro Visit

Rep. James C. Davis (D., Ga.) today criticized the American Society of Newspaper Editors for inviting Cuban revolutionary leader Fidel Castro to address its meeting here Friday.

Rep. Davis said the Logan Act, which prohibits American citizens from unauthorized correspondence with agents of foreign governments for certain purposes, may provide the answer to the sticky problem posed by Castro's impending visit.

Rep. Davis echoed in a newsletter the charge some weeks ago at ASNE by Sen. Wayne Morse (D., Ore.). He said ASNE "circumvented all protocol" by inviting Castro to the United States "without first getting clearance from the State Department." UPI.

[Redacted]

SEARCHED [] INDEXED []
SERIALIZED [] FILED []

APR 14 1959

[Redacted] STON [Redacted]

[Redacted]

b3
b6
b7C
b7E

HE'S HERE THIS WEEK

Castro Will Plead for 'Understanding'

By ANDREW TULLY Scripps-Howard Staff Writer
(See Peter Edson on Page 27.)

Fidel Castro will come to the United States tomorrow to plead for understanding for Cuba's revolutionary government because he "cares greatly" what the United States thinks about the new regime.

This was the word today from a high Cuban diplomatic spokesman, here from Havana to help make arrangements for the premier's five-day stay here in Washington.

Castro will arrive here by plane tomorrow night as the invited guest of the American Society of Newspaper Editors, whose annual meeting convenes Thursday. He will address the editors Thursday afternoon, and will speak at a National Press Club luncheon on Monday. In between, he will confer with Vice President Nixon and with Acting Secretary of State Christian Herter.

OUTLINE

Castro's spokesman made it plain he could not speak for the 32-year-old Prime Minister in detail, but said he could furnish a broad outline of Castro's attitude toward the U. S. That attitude, he said, was one of "fierce desire" for friendly relations between the two countries.

It was explained that in the past Castro has been hurt by and resentful of American attitudes toward the revolutionary government. Specifically, he has been irritated by press comment and by speeches made by certain

members of Congress attacking the war criminal trials and executions.

PERSUADED

But now, it was said, Castro has been persuaded that the official American attitude is one of wanting to help the new government, of wanting to maintain the traditional friendly relations between the two countries. This persuasion has come almost entirely, it was said, from our new ambassador in Havana, Philip Bonsal.

Castro was pictured as "most favorably inclined" toward Ambassador Bonsal as a result of several conferences with the American envoy. "He respects Mr. Bonsal and trusts him," the spokesman said of the Cuban Prime Minister. "He has found Mr. Bonsal most understanding."

SEARCHED... INDEXED...
SERIALIZED... FILED...
APR 14 1959

b3
b6
b7C
b7E

CONSTANTINE BROWN

Recognizing New Dictators

Newspaper Editors' Invitation to Castro To Speak in Washington Is Criticized

Fidel Castro, self-appointed Prime Minister and supreme boss of Cuba, will be given the same treatment of "unofficial courtesy" which the State Department gave Soviet Deputy Premier Anastas Mikoyan.

Both have bloody hands—Mikoyan from tens of thousands of Hungarian freedom fighters; Castro from the blood of many innocent Cubans.

It is barely conceivable that, burdened by responsibility and anxious to maintain his position of power, Prime Minister Castro eventually may change and become "just another Caribbean dictator" and forget his leanings toward the political and social doctrines of Marx Lenin and Stalin.

Castro's predecessor, Fulgencio Batista, started his dictatorial career as a revolutionary whose heart was bleeding as much for the underprivileged masses as that of Castro. The signal for the revolution was given when President Machado ordered a cavalry regiment to ride over strawberry patches belonging to independent growers who were competing with the personal friends and supporters of the dictator. Then (in 1933) as now Moscow agents were roaming the islands and inciting people to arson and murder.

Washington recognized the new regime in Cuba at that time because the man who brought about the revolution, cavalry sergeant Fulgencio Batista, held no official position in the newly formed government. It was seven years later, in 1940, that he became Cuba's President. Thus in recognizing the revolution which threw out the ruthless Machado-de Cespedes administrations, we did not depart officially from our policy of having no truck with dictators or military juntas.

The fact that Batista had no official role (although we knew he ran Cuba) enabled us to recognize the new regime without losing face. In

those days the American Government was less prone to adopt the expediency policy in its foreign relations. It had just been decided to recognize the Communist government in the Soviet Union because, it was said, the blood on the hands of its rulers had long ago dried up. But the men in the State Department and White House would not dream of clasping hands with rulers whose hands were still dripping with the blood of their victims who preceded them in office.

The tenets of morality of the administration in Washington and for that matter, judging by the invitation extended to Fidel Castro by the American Society of Newspaper Editors, also of the American people have changed in the last quarter-century. Our Government has definitely adopted expediency as a policy in its dealings with foreign governments.

The old inflexible rule that you don't deal with murderers who become monarchs or presidents of republics is being abandoned. The yardstick for recognition is now expediency—and that is frequently misjudged by domeheads in the State Department who write "policy papers." The most blatant example is that in Iraq last summer when we recognized the regime of the murdering gang of Gen. Abdul Karim Kassem within a very few days after the bodies of our loyal friends, King Faisal and his top advisers, had been thrown in a ditch. The explanation given by our policy-makers was that Kassem might not become a tool

of international communism and if we handled him properly might remain in the Baghdad pact.

The present developments in the Middle East show how pathetically wrong were those who urged quick recognition of the Iraqi regime. When we rushed with equal speed to recognize Fidel Castro, we merely followed the new pattern of expediency rather than political morality. At the present time the free and Communist worlds alike recognize that this is the modern trend. The actions of governments do not, however, always reflect the feelings of the people. It is for this reason that the invitation extended to Castro by the ASNE is regarded as more important than the recognition of the Cuban dictator by the American Government.

Newspaper editors do not have to adopt expediency in choosing the honored guests who will address them. They can afford to be highly selective. The fact that Castro may be "news" is no argument in favor of inviting him. These men who are the greatest force in molding American public opinion do not need to make sensational headlines at their yearly meeting.

The editors' reception of Fidel Castro will reverberate all over the seething, restless and strife-ridden Southern Hemisphere where Khrushchev is now trying so hard to make hay.

THE EVENING STAR
Page A13 Date 4/14/59

SEARCHED	INDEXED
SERIALIZED	FILED
APR 14 1959	

Castro Arrives Here Tonight; Threats Bring Tight Guard

By JOHN V. HORNER
Star Staff Writer

Prime Minister Fidel Castro of Cuba will arrive here tonight and officials frankly don't know what to expect.

The controversial leader of the Cuban revolution is coming on an unofficial 11-day visit, but he will receive about as much official protection as is possible to provide, beginning with his arrival at 7 p.m. at the Military Air Transport Terminal.

Because threats against his safety have been received both at the State Department and the Cuban Embassy, rigid security precautions are being taken in behalf of the bearded 32-year-old Premier and the large party he is bringing with him.

Officials said they would not be surprised if anti-Castro demonstrations or picketing developed, although they would not hazard a guess as to where or when demonstrations might occur.

Some picketing appeared certain, however. Raphael del Pino, the head of an anti-Castro group called the Anti-Communist Movement for the Americas, said this afternoon that some sign-carrying pickets would parade in front of the



FIDEL CASTRO
Arrives Tonight in D. C.

—AP Wirephoto

White House late today and also at the airport. He said the pickets would be in evidence as long as Mr. Castro is in the United States, but promised there would be no violence of any kind.

Much of the feeling against Prime Minister Castro is found among supporters of Dictator Fulgencio Batista, who was overthrown last New Year's

Day as the culmination of Mr. Castro's long revolution. There are other Cubans, however, who do not support Batista and yet vigorously object to Mr. Castro.

In addition to these elements, there are numerous American citizens who resent the continuing denunciation of United States policy by Mr. Castro and who find fault with his own conduct since he assumed his high political office.

The entire security division of the State Department, assisted by the Washington Metropolitan police, is assigned to the Castro party from the time of its arrival until the scheduled departure the afternoon of April 26.

One official expressed the belief that the security measures being taken for this visit are even stricter than those applied when Russian Deputy Premier Anastas Mikoyan was here in January. The guard at the airport tonight will be extremely tight and at one social function for Mr. Castro invited guests will be required to present cards of admission at the door.

Security officers were finding their job more difficult than usual because of uncertainty regarding Mr. Castro's itinerary and also because they have

See CASTRO, Page A-26

CASTRO

Continued From First Page
been unable to ascertain the number of persons accompanying him here.

Even today, officials had not been informed by the Cuban Embassy of the exact details customarily provided in connection with visits of foreign leaders.

Prime Minister Castro will fly here in a Cuban Airlines plane which can accommodate 95 passengers. The estimates of the size of his party have ranged all the way from 35 to 94.

The Cuban leader is to be met at the airport by a State Department delegation headed by Assistant Secretary of State Roy R. Rubottom, jr.

Wiley Buchanan, protocol chief of the State Department; William A. Wisland, director of the Office of Caribbean and Mexican Affairs, and Robert A. Stevenson, officer in charge of Cuban affairs, also will be in the welcoming party.

Mr. Castro decided to come to Washington on the invitation of the American Society of Newspaper Editors, which is holding its annual convention at the Statler Hilton Hotel this week end. The Premier will speak to the editors Friday afternoon.

Some Criticism Aroused

The invitation has aroused criticism among some members of the society. But George W. Healy, jr., of the New Orleans

Times-Picayune, president of the society, said the invitation does not mean any endorsement of Dr. Castro's methods and policies.

"This man has made news. We should see him and hear him in order to understand him better and perhaps for him to understand us better," he said.

A capacity audience already is assured for that appearance, and also for a luncheon meeting of the National Press Club, which the Cuban will address Monday.

The Prime Minister will be the guest of Acting Secretary of State Herter at a luncheon tomorrow. He will be received by Vice President Nixon at the Nixon home Sunday evening.

On his social calendar are two receptions, one for members of the Cuban colony Friday afternoon and one for diplomats and Government officials Saturday.

Mr. Castro proposed to visit the Tomb of the Unknowns, the Lincoln Memorial, the Jefferson Memorial and Mount Vernon Sunday. He is also scheduled to appear on the NBC television network

SEARCHED [] INDEXED []
SERIALIZED [] FILED []

b3
b6
b7C
b7E

Fidel Castro's Task

1724
A great opportunity awaits Fidel Castro as Cuba's ebullient Prime Minister begins his visit to Washington, and the future relations between his government and ours may well hinge on how effectively he uses it. The revolution which Castro led developed into a profound popular uprising with few parallels in the hemisphere. Few question the heroism and daring of Fidel Castro, the rebel. Sober questions have arisen, however, about the stewardship of Prime Minister Castro. Doubtless Castro will face some hostile questioning here. But he will also discover a fund of good will for the government he heads, as well as an honest concern for the economic difficulties of Cuba. Castro has a chance now to help resolve doubts and disclose something of the true face behind the beard. Whatever the feelings about Castro, he deserves an attentive and sympathetic audience. We are confident that is what he will receive.

[Redacted]

SEARCHED	INDEXED
SERIALIZED	FILED
APR 1 1959	

[Redacted]

b3
b6
b7C
b7E



By Dick Darcey, Staff Photographer

Cuban Premier Fidel Castro is surrounded by Cuban Embassy aides and other well-wishers upon his arrival at National Air Force Base last night. The Premier's plane, scheduled to arrive here at 7 o'clock, landed two hours late. Story on Page A1.

TV Correspondents Blast Editors For Ban on Castro Talk Coverage

United Press International

The American Society of Newspaper Editors ran into sharp criticism yesterday for banning television coverage of Fidel Castro's appearance before the Association on Friday. The Radio and Television Correspondents' Association said the ASNE was "engaging in an arbitrary suppression of freedom of access to the news which the ASNE has so long fought valiantly against." The Freedom of Information Committee of the Radio-Television News Directors Association said the ban "only tends to strengthen the hand of those agencies of govern-

ment and the courts which have offered such resistance to all news media in the dissemination of news." The National Association of Broadcasters was "shocked and bewildered" by the edict. ASNE President George W. Healy Jr. reviewed the order with the full ASNE board of directors. Afterwards, he said the policy still stood. He said it would not be "feasible" to permit bulky TV cameras and equipment at the standing-room-only affair. Radio coverage will be permitted on a "pool" microphone basis. Julian Goodman, president of the Radio and Television

Correspondents' Association, wrote Healy that the TV industry "probably will survive this blow." But he said "freedom is not a matter of degree, and it is not something limited to the writing press." Chairman John F. Lewis of Radio-Television News Directors Association said the action was "completely at odds with the traditional stand of those in the news business." He said the news industry "cannot stand as a house divided."

Harold E. Fellows, president, wrote Healy of the National Association of Broadcasters' complaints. He urged Healy to reconsider the action, saying "we cannot conceive of your taking this position in view of your historic struggle to preserve and maintain free access to the news."

Smathers Asks OAS To Keep Latin Peace

Associated Press

Sen. George Smathers (D-Fla.) said yesterday leaders in Fidel Castro's Cuban government are apparently organizing to invade other Latin American countries.

Smathers, in a Senate speech, called for the Organization of American States to establish a police force to maintain peace.

He urged that the United States scrap the 66.8 million-dollar military aid program proposed for Latin America next fiscal year and divert some of the funds toward building a peace patrol of volunteers from the 21 member states.

b3
b6
b7C
b7E

Comes Dressed in Fatigues

Castro Arrives at National Airport, Makes Detour to Greet Admirers

By Harry Gabbett
Staff Reporter

Cuban Premier Fidel Castro arrived at National Airport last night amid chorus of cheers and catcalls for an 11-day visit in this country.

His arrival, two hours late because of a delayed departure from Havana, evoked the tightest security precautions since the recent visit of Soviet Deputy Premier Anastas Mikoyan. Here at the behest of the American Society of Newspaper Editors whom he'll address Friday at the Statler-Hilton Hotel, the bearded 32-year-old leader has scheduled a number of public and TV appearances.

Although his visit is strictly informal, the State Department was generously represented among his official greet-

ers at the airport. He'll lunch with Acting Secretary of State Christian A. Herter today and presumably will discuss his avowed intention of obtaining American help to rebuild his revolt-torn island republic.

A couple of hours before his arrival, some 30 men and

Picture on page A2

women picketed the White House in an anti-Castro demonstration supervised by Rafael del Pino, Castro's one-time revolutionary partner, who since has accused him of Communist leanings. There was no incident, although Cuban security police at the airport reportedly turned away a group of Georgetown University students who announced they were on hand to protest

Castro's execution of "war criminals."

Castro's Secret Service guards had their work cut out for them at the Airport when their energetic charge bypassed his waiting limousine to greet personally some of the estimated 1500 persons who lined an Airport fence to welcome him.

For his trip here, Castro wore his usual rebel battle fatigues, as did many of the bearded members of his official party. He looked startled momentarily when a reporter, brushing against him, commented that he obviously carried no sidearms.

"For what?" he inquired with a quick smile.

His arrival was preceded by a number of telephoned threats.

SEARCHED [] INDEXED []
SERIALIZED [] FILED []

APR 16 1959

We Welcome Dr. FIDEL CASTRO

The National Hero of the Cuban People

On His Visit to Washington, D. C.

The American people, who have engraved magnificent pages of history in the defense of liberty, democracy, and human rights, gave their generous support and sympathy to the Cuban people in their fight against the terrible tyranny of Batista. Fidel Castro, the young leader who with the support of an army made up of Cubans from all walks of life realized the epic feat of routing a professional army of 40,000 men equipped with all types of modern arms, now, as Prime Minister, is dedicated to the work of consolidating a government of liberty, democracy and prosperity for all the Cuban people.

We, Americans and Cubans, who in Washington gave our support to the struggle that Fidel Castro symbolized, hope that his visit to the Nation's Capital during Pan American week will contribute to a better understanding of the true democracy that today exists in Cuba and of the aspirations of the brave Island Republic, which traditionally maintains the warmest ties of friendship with the United States.

CASTRO SAYS:

In explaining the varied aspects of the program which the new government is developing Fidel Castro has said:

About Economic Conditions:

"Our most serious problem is that the population grows constantly and, in contrast, the sources of employment do not increase. And, by the same degree to which industry adopts new technology and needs fewer and fewer workers, our population increases, and we find ourselves in a vicious circle from which there is no escape—men who have no work and who cannot be consumers, and an industry that cannot develop because it does not have consumers. . . . Our new industries could not hope to compete fundamentally with foreign industry; thus it must develop on the basis of domestic consumption and produce the largest possible quantity of articles and goods to be consumed in this country. . . . The capital for industries will be partly Cuban and partly foreign."

About Land Reform:

"Here in Cuba we have 800,000 families who are farmers and who have no land of their own. Those farmers work two or three months a year, during the sugar season only. They have no work for the rest of the year, they have no land to sow or to produce the most necessary things for their consumption. Many of those farmers come to the city seeking jobs, and they increase the number of unemployed people in the cities."

"More than half of the country is rural and we have to convert it into a consuming population. Those farmers will never be consumers if they do not have land to produce things. The agrarian reform will increase many times the purchasing power of the farmer, and it will be the base for industrial development in Cuba."

About Communism:

"The Twenty-sixth of July Movement is not a Communist movement."

About the Ideology of the 26th of July Movement:

"The Twenty-sixth of July Movement is a truly revolutionary movement, which intends to build the economy of the country on just foundations, which is at the same time a revolutionary movement and a democratic movement with ample human content. . . . The ideology of the Twenty-sixth of July Movement is the ideology of social justice within the limits of the most ample democracy, liberty and human rights."

Interfiled for U. S. News World Report, March 16, 1959

THE AMERICAN PRESS SAYS:

Since the 1st of January, 1959, hundreds of newspapermen from all over the world have visited Cuba without restrictions of any sort. In the last few days the following statements have appeared in the American press.

"On the basis of its three-month record Catholic opinion regards the Castro regime as striving mainly to correct what it views as the worst abuses of the Batista past: social injustice, public corruption and widespread oppression. . . . Catholic leaders approve the government's action in launching a program of land reform, starting construction of housing developments for the needy, bringing the prices of food and necessary services within the reach of the masses and striving to provide more and better schools."

The Catholic Standard, Washington, D. C., April 16, 1959

"Cuba's new government needs our sympathy and help more than our hasty sermonizing about how to finish a revolution we had no part of. It needs to sell us more sugar. Our new career ambassador Philip Bonsal may be able to win back some of the respect for America that was lost by our last two politically appointed envoys. . . . The American business community is going to have to get used to dealing with officials who won't demand bribes, and with police officers who can't be put on company payrolls in case of labor troubles. . . . We can thank our lucky stars that Castro was not a communist."

William Attwood, Foreign Editor, LOOK, March 7, 1959

"Dr. Castro heads for the United States next Wednesday to seek aid in reconstruction of his nation's shattered economy—Castro and his aides have established what is probably the first honest administration in the history of the Republic."

Francis L. McCarthy, UPI's Havana Correspondent, April 11, 1959

"Until January 1, 1959, an ironclad tyranny held the island of Cuba in its grip. Only 90 miles from the United States, dictator Batista was conducting a regime of terror and corruption without parallel in Cuba's tragic history."

"Now Cuba is free of that dictator and there is hope of democracy in the air."

Dickes Chopelle in READER'S DIGEST, April, 1959

"On December 27, four young student leaders were put to death on the outskirts of Havana with a savagery that beggars description. The more than 2,000 friends of those young men who attended their funeral, like the friends of the 15,000 or 20,000 other victims of the fallen regime's excesses, look to the present Government for an order of justice that will punish guilt where guilt exists. They look to it also to provide a healthy atmosphere for national life. So far they have found in this new Government's action reasons to justify their hopes."

Eugene K. Guthrie in AMERICA, National Jesuit Weekly, February 14, 1959

"The United States is too powerful and too involved with Cuba's economy not to have strong influence. But much of this influence will be dissipated if not actually reversed unless there is more understanding when the need arrives. At present there is misunderstanding on both sides, but if our country is as mature and responsible as it asserts itself to be it should be the more willing to extend itself for a government which is coming under heavy criticism before it gets fairly under way."

James Finn in the COMMONWEALTH, Loy Catholic Weekly, February 20, 1959

RECOMMENDED READING:

To all Americans interested in the story of the Cuban revolution and its leader Fidel Castro, we recommend Mr. Jules Dubois' recent book "Fidel Castro." Mr. J. Dubois is the Latin American correspondent of the Chicago Tribune. Also, we recommend an article currently appearing in the April issue of the Reader's Digest "Remember the 26th of July" by Dickey Chapelle.

AMERICAN CUBAN COMMITTEE FOR RECEPTION TO DR. FIDEL CASTRO

A group of private citizens of Cuba and the United States donated the cost of this message to the American people.

By authority of Y. J. Lombros

SEARCHED [] INDEXED []
SERIALIZED [] FILED []
APR 16 1959
FBI - WASHINGTON

b3
b6
b7C
b7E

Commies' Rise in Cuban Labor By John Herling



TODAY in Cuba, a communist labor leader once sponsored by Dictator Fulgencio Batista has emerged as a close collaborator in the labor movement established under the regime of Fidel Castro, the man who chased Batista out of Cuba.

The man is Lazaró Peña whose evil power flowered under the Batista dictatorship until 1944 during a period of intensive collusion between communists and the Batista regime. Sr. Peña then headed the Cuban Federation of Labor.

The story of the cataclysmic rise of communist influence today in the Cuban labor movement is this:

A year ago, the general strike called by Sr. Castro's "July 26" Liberation movement fizzled due to inexperience, and the lack of contact with organized labor groups in Cuba. This failure created a vacuum which the communists immediately rushed in to fill. Dr. Castro's forces were ready to take help where they could find it.

The man in charge of labor affairs for Sr. Castro was and is David Salvador, who is in his early 30's. Mr. Salvador became the bridge for communist traffic. He was once active in the Sugar Workers Union and, for a while, was a communist. Later he was active with the young Catholic group.

Early this year, the communist and "July 26" forces fanned out to all the Cuban unions. A United Labor Committee of 22 was set up—called FONO for its Cuban initials—on which sat five commies, seven members of the "July

26" movement, with the rest from other anti-Batista groups—Auténticos, Ortodoxos, and others.

Following the classic communist "united front" pattern, Sr. Peña and Ursino Rojas, a communist leader in the railroad unions, deployed their members thruout the labor movement. The obvious communist grip on the FONO caused a sharp public reaction and FONO was dissolved. Succeeded by a nine-man directorate, with David Salvador continuing as the leader, the commies have multiplied their influence. The dissolution of FONO did not slow them down.

Commies control, in whole or in part, the following key Cuban unions: sugar workers, restaurant and hotel workers, tobacco workers, railroads, local transport, port workers, construction workers. In all, 29 out of 33 affiliates are under direct commie influence or control.

Instead of trying to recruit leadership from non-communist and tested anti-Batista sectors of union leadership, Sr. Salvador, as Prime Minister Castro's man in charge, prefers to bring commies—including Mr. Batista's Lazaró Peña—into positions of union power.

All this may be further evidence of that ignorance of the labor movement which many believed had characterized the Castro liberation drive before the Batista overthrow. This certainly is an example of how commies entrap the unwary by insisting on political repayment for favors done to the unwary.

At any rate, elections in the trade union movement will be held late this month or early May. With communists permitted and encouraged in a free run on the Cuban movement, the results seem a foregone conclusion.

[REDACTED]

SEARCHED	INDEXED
SERIALIZED	FILED
APR 16 1955	

[REDACTED]

b3
b6
b7C
b7E

GUARDS HAVE A JOB TO DO

Castro Sets Out to Win Friends

Cuban Prime Minister Fidel Castro, greeted by wildly cheering fans and picketing opponents, started a round of appearances today to win new friends for his regime.

The only scheduled appointment on the first day of his 11-day U. S. visit was lunch with acting Secretary of State Christian A. Herter.

But associates said the unpredictable Castro might give his worried security guards more headaches by getting a whim to go off shopping or sightseeing.

An American official said precautions taken to protect the 32-year-old Cuban leader were tighter than those applied when Soviet Deputy Premier Anastas I. Mikoyan visited here in January. The Cuban Embassy and U. S. State Department have received anonymous threats against Dr. Castro's life.

Dr. Castro hopes to win better U. S. understanding for his government. He also has said he will seek loans and a larger share of this country's sugar quota.

500 ON HAND

The bearded prime minister, dressed in his famous army fatigue uniform, was welcomed by 500 well-wishers when he arrived more than two hours late in a Cuban airliner last night.

Guards tried to hustle him into a limousine. But he pushed them aside and strode over to shake hands with fans who had been kept off the field by a fence.

Shortly after arriving at the Cuban Embassy he again upset security precautions by dashing across the street to greet knots of onlookers there.

At the embassy he told a

reporter in Spanish that his welcome had been "very fine." He said his greeters were "very nice people and nice reporters."

Dr. Castro will be guarded by State Department security officers, his own agents and local police.

STUDENTS BARRED

Cuban guards, exercising a privilege granted to visiting dignitaries, checked the small group allowed on the field. They turned away about a dozen Georgetown University students who said they opposed Dr. Castro's executions of Batista followers.

The Prime Minister was officially greeted by Cuban Ambassador Ernesto Dihigo, Assistant Secretary of State Roy R. Rubottom Jr., Chief of Protocol Wiley T. Buchanan and George W. Healy Jr., president of the American Society of Newspaper Editors and editor of the New Orleans Times Picayune.

Thirty-three persons, representing the "Anti-Communist Movement of the Americas," picketed in front of the White House to protest Dr. Castro's trip. Dr. Castro came to this country at the invitation of the American Society of Newspaper Editors to speak to the group's annual meeting tomorrow.

He will be the guest of Vice President Richard M. Nixon at a reception Sunday, appear on the TV panel shows Face the Nation (CBS) and Meet the Press (NBC) the same day, and speak to the National Press Club, Overseas Press Club, UN Correspondents and a number of other groups. (UPI)

Warm Welcome



—UPI Photo.
Cuban Ambassador Ernesto Dihigo embraced his prime minister warmly at National Airport when Castro arrived last night for his goodwill visit.

b3
b6
b7
b7

SEARCHED [] INDEXED []
SERIALIZED [] FILED []
JUL 16 1959
[]

DAVID LAWRENCE

Fidel Castro to Face Accusers

New Cuban Dictator Seen on Trial Before Court of Public Opinion

Unlike the treatment he gave scores of his fellow countrymen whom he ordered executed without fair trials, Fidel Castro is being given a chance to face his accusers in the United States.

For Cuba's dictator is himself on trial now in the court of public opinion in this country. He has an opportunity in the next few days to make speeches before press organizations here and in New York and before some college audiences as well. He can reply to the charges made against him in the news dispatches of recent weeks telling of the perfunctory trials and his application of the death penalty in more than 500 cases.

But the major indictment against Fidel Castro is that he has done irreparable harm to the prestige of the government of Cuba in this hemisphere and throughout the world. Americans used to feel that they could go to Cuba without fear and with a feeling that this next-door neighbor to the United States was a friendly one. Today there are confirmed reports about Communist infiltration in Cuba. In fact, there are plenty of comments by Fidel Castro himself, showing contempt for the United States and for Americans in general. These are unlike the utterances of any man who has previously headed the Cuban government in the more than 60 years of its existence as an independent country.

The Cuban leader keeps arguing that the dictator who preceded him was guilty of many crimes and sins against the Cuban people. But Anglo-Saxon principles of common law have for centuries set forth the truth that two wrongs do not make a single right and that even the worst

criminal is entitled to a fair trial.

Fidel Castro is reported to be planning to ask the United States Government for financial aid. This is surprising in view of his hostile comments about the United States. It reveals an amazing unfamiliarity with the reaction in this country to what has happened in the last few months in Cuba.

The Washington government has had to deal with dictatorships in Latin America for many years, and it tries to steer away from any intervention in internal affairs. This course is criticized at times by those who have big investments in a particular country and who usually come forth with the suggestion that America deal with the existing government and let the question of democracy or dictatorship be handled by the citizens themselves.

But the moral force of the United States is being exerted today on the side of decency and freedom for the people of every country. When Deputy Premier Mikoyan came here from the Soviet Union not long ago, it was not widely publicized in advance that he was largely responsible for the murder of many Hungarian citizens. When the people in America did get the facts, there were many emphatic expressions of disapproval.

Fidel Castro comes to visit the United States under somewhat different circumstances than did Mikoyan. The American people have been fully advised that the Castro idea of justice is to place before a firing squad anyone he pleases who has sided with the predecessor government. Certainly, the Batista government, which had been formally recognized as the ruling regime, may have carried on a vendetta against its enemies, but what

ever happened was carefully hidden from view. Unfortunately for Fidel Castro, perhaps, the stories of the 500 or more executions of Cubans have been widely printed. The American people know what happened. Had they been told about Batista's misdeeds at the time, they would have felt the same shock. But it is no excuse to say that Castro is justified now in ignoring the simple principles of justice just because Batista was a tyrant, too.

The United States Government, since the days of President Wilson, has endeavored to discourage military revolutions as a means of changing administrations in the countries of Latin America. Back in 1913, the United States refused to recognize a government in Mexico headed by Gen. Huerta because he rose to power by assassination of President Madero. This policy of nonrecognition was subsequently modified as revolutions increased in Latin American countries. Indeed, it was argued that a revolution to upset a dictator and to bring a democratic form of government was to be condoned as a necessary step and that recognition should not be withheld from such a regime.

It would be much better, however, if in all cases of revolution only "de facto" recognition were given to new governments and if "de jure" or lawful recognition were accorded later only when an election had been held that was universally accepted as a reflection of the true will of the people uninhibited by any form of coercion of the voters. In recent years, expediency has seemed to get the upper hand. Fidel Castro's behavior, therefore, may bring a reevaluation of the moral principles to which the Department of State used to be dedicated a few decades ago.

(Copyright 1959)

b3
b6
b7C
b7E

SEARCHED
INDEXED
SERIALIZED
FILED

U. S. & Fidel Come to Grips

Questions for Castro

By JOSEPH U. HINSHAW, UPI Correspondent

Cuban Prime Minister Fidel Castro goes before the U. S. newspaper editors today to answer charges that communists have infiltrated his government.

The bearded 32-year-old Castro also is expected to spell out in his lunch speech to the American Society of Newspaper Editors why he believes the U. S. press has not given a true picture of his revolutionary regime.

Dr. Castro probably will be asked during a question and answer session after his speech to justify his mass executions of followers of former Dictator Fulgencio Batista. Dr. Castro's forces toppled Batista's government on New Year's Day.

A SPEAKER

The Prime Minister, here for an 11-day goodwill visit, promised to speak for 30 minutes. But he has been known to speak for three or four hours on other occasions.

As usual there was no prepared text for Dr. Castro's remarks. He will wear his famous jungle green open-collared fatigue uniform.

Dr. Castro said in advance he would deliver part of his speech in English and part in Spanish. He said he would try to answer questions in English but would keep an interpreter at his elbow in case he needed him.

A controversy over broadcast coverage of the appearance was settled when the society agreed to let radio and television services record Sr. Castro's speech on tape and film for later airing.

Sr. Castro came to the United States specifically to speak to the ASNE annual meeting. He has expanded his itinerary to include appearances before other groups and on two TV panel programs.

RECEPTION

The revolutionary leader's only other scheduled engagement today was a reception at the Cuban Embassy for Cubans living in this area. The affair was expected to be jammed with well-wishers.

Sr. Castro gave an indica-

Clarence Moore, publisher of the Havana Times, an English-language daily, has written an open letter to Dr. Castro which appears on Page 38. Mr. Moore's paper was openly hostile to the toppled dictator Batista and has supported Dr. Castro's regime, but he has some trenchant questions for the young revolutionary leader.

his ASNE speech while chatting with newsmen after having lunch with acting Secretary of State Christian A. Herter yesterday.

Without directly criticizing the American press, he complained that people in this country have not been informed of the complete truth of what is going on in Cuba.

He said, "I hope I will now be able to reach the U. S. people and explain what we stand for." He said public opinion here would back his regime overwhelmingly if he could talk on television every week.

As for the executions, Dr. Castro said, "Almost all of the war criminals have been punished." He said, "It is hard for us to apply this justice but we are saving many future lives by punishing the guilty."

During a stroll later thru Meridian Hill Park, one block from his embassy, Dr. Castro told a group of students, "In Cuba there is (no) not communists, not capitalists but Cubanists."

The Prime Minister shook hands, signed autographs and posed for photographs during his walk thru the park and nearby streets. A crowd of 300 persons swarmed around him. At one point he

b3
b6
b7C
b7E

SEARCHED _____ INDEXED _____
SERIALIZED _____ FILED _____
APR 17 1959

An Open Letter to Fidel Castro

The following is reprinted from *The Times of Havana*, young English language newspaper which, in the opinion of *The Washington Daily News*, printed some of the best editorial comment in Cuba on the revolution. Clarence Moore, publisher of *The Times*, is an American citizen who makes his home in Havana.

DESTINY has placed you on a pinnacle reached by only a few men in each century, and charged you with responsibility far beyond that required of the average leader. This week, as you visit a country that treasures freedom, may you walk with wisdom and forbearance.

You take with you the hopes and fears not only of Fidel Castro, not only of his adherents, Cubans, and all who love Cuba, but just as much you carry the hopes of everyone in the world who believes in the dignity of the individual and his right to a better life. In your hands is the power to touch the course of history. With you go the dreams of the free world.

The Times of Havana salutes you and reiterates that you are equally capable of representing Cuba and freedom. But you must remember that you will be in a country where liberty has been so long enshrined that it is accepted almost without thought. As you yourself have said, we have no memories of dictators or of oppression. We know liberty as a living thing, a challenging concept, and our untrammelled press operates in that open atmosphere. Our newspapers flourish in disciplined tolerance, and our reporters can pierce the icy calm of an Eisenhower, rip open the Midwestern good humor of a Truman, plague and annoy great men for whom they have an absolute moral respect. It is at these times that you must carefully gauge the give and take of a wide-awake press. With the wit you have often demonstrated, the intelligence which is so obvious, and the courage that carried you thru bitter years to cherished ideals, you can carry the day and increase your heroic stature.

The Times of Havana was born in Cuba and is growing to maturity in a new air of freedom. We took no financial help from Batista, a fact recently publicly acknowledged by the Inter American Press Association which listed *Pressa Libre*, *Carteles*, *Bohemia* and *The Times of Havana* as the only publications which refused such aid.

Our employees wondered how our many barbs got by the ever-present censor.

And our editorial "Spokesman for Whom?" slapped at U. S. Sen. Ellender who visited Cuba last December with the suggestion that the U. S. again send arms to Batista. Our editorial stood out against banner stories thruout the Cuban press which lauded the Senator.

As publisher of *The Times*, I visited Washington as an independent businessman in January to plead the cause of the new Cuba. And I will be in the Statler Hotel to hear you speak (today).

While you were still coming up your heroic path from the interior of Cuba, our Jan. 4, 1959, editorial was widely used thruout the United States. In it we said that "Once again man has shown that he will not endure evil without end. The future of Cuba now lies in the hands of young Cubans. May they keep their honor and pride unscathed. Everyone of us hopes that their idealism under suffering will be translated into wisdom and justice in administration." Thus this paper feels, and thus the world feels.

You can expect that the United States will receive you as an honored guest. Its officials will sympathetically offer you any help that that great country can give. You can just as surely expect specific inquiries.

• They will surely ask you to define Cuba's position in the fight against communism, which is a tyranny more enormous than ever confronted by Cuba. How free do you think Cuba would be today if it were geographically less than a hundred miles from a communist power?

• And they will ask you why a journalist of a leading daily should be jailed for two weeks incommunicado, out of reach of his own lawyer.

• They will be analytical in their approach to Cuba's economic situation, in the realization that a revolution is not something that can be turned on and off at will.

But above all, they will know that they have as their guest a man who brought liberty to his country. May your days in the United States show you that it is a bulwark of freedom, and that its people envision just as you do, a better life for free men.

CLARENCE W. MOORE
Publisher.

SEARCHED	INDEXED
SERIALIZED	FILED
APR 17 1959	

b3
b6
b7C
b7E

Dope Peddler List Got Lost in Cuba

U. S. Narcotics Commissioner Harry J. Anslinger said today he has been told that a list of 50 dope peddlers in Cuba he sent to the Castro government has mysteriously disappeared.

Mr. Anslinger told United Press International the disappearance was reported to him last week by a Cuban official who phoned him to ask for another copy.

He identified the official as Castro Verde, Cuban representative of Interpol, the international police organization. He said Sr. Verde told him the list could not be located at the office of Cuban President Manuel Urrutia, where Mr. Anslinger sent it.

The list was compiled in January by Mr. Anslinger's staff at the request of An-

tonio de La Carrera, then private secretary to Sr. Urrutia.

There appeared to be some difference of opinion between narcotics and customs officials as to just how aggressively the Castro government is moving against narcotic dealers and shippers.

Top customs agents here said the Castro government is making a "sincere effort" and has been "very cooperative." They said they were following up in the United States leads passed along by Cuban officials last week when they seized 1000 grams of cocaine.

[Redacted]

SEARCHED	INDEXED
SERIALIZED	FILED

[Redacted]

b3
b6
b7C
b7E

Castro Starts Drive To Win U. S. Friends

Cuban Premier Lunches with Herter; Invitation by Editors Criticized

By JOHN V. HORNER

Star Staff Writer

Prime Minister Fidel Castro, hailed by hundreds of enthusiastic admirers on his arrival here last night, today launched his carefully planned campaign to win the friendship of the American people.

The 32-year-old rebel who upset the Batista dictatorship, still bearded and wearing the drab fatigue uniform of the soldier, scored an important gain by getting an audience with some of the administration's highest ranking officials.

As a start, he was the

Three Women Aides to Castro Tell of Struggle to Power Page B-1

luncheon guest of Acting Secretary of State Herter at the Hotel Statler. Approximately 25 other persons, including Cuban and United States officials, were present.

Complains Again

Before leaving the Cuban Embassy en route to the luncheon, Mr. Castro renewed his complaint to reporters about coverage in the American press. He said the distortions about him continue and declared that an example was the report that his appearance would be picketed.

He said there had been a lack of demonstrations against him and he was happy to see so many smiling people.

Mr. Castro's 11-day visit to the United States is technically unofficial. He was invited to Washington to address the convention of the American Society of Newspaper Editors to-

See CASTRO, Page A-6

CASTRO

Cuban Premier Sees Herter at Luncheon

Continued From First Page
morrow, and he took advantage of the opportunity by arranging a large number of appearances, both public and private. Sunday evening he will go to the home of Vice President Nixon for an informal talk.

It is expected that economic problems of Cuba will have a high priority in his discussions here. Accompanying him on the trip from Havana late yesterday were several leading economic figures of his provisional government and the president of his country's national bank.

At the editors' meeting tomorrow afternoon and in a talk to the National Press Club at a luncheon Monday, Mr. Castro will have opportunity to carry directly to newsmen his charges that there is a "campaign of vilification" against his government in the American press.

Despite a tight security guard provided by the State Department and Washington police, hundreds of excited Cuban and American backers of Mr. Castro all but mobbed him when he landed at the Military

Air Transport Service terminal at 9 o'clock last night, two hours behind schedule.

Other hundreds swarmed around the prime minister when he reached the Cuban Embassy on Sixteenth street N.W., and he shocked security officers by nonchalantly strolling across the street to shake hands with another big, cheering crowd.

Some protests were heard from anti-Castro people who showed up at the airport. And a small group of opponents, headed by Rafael del Pino, picketed briefly in front of the White House to indicate disapproval of the revolutionary leader. Mr. del Pino was a former colleague of Mr. Castro and said he broke with the Prime Minister over the question of Communist support.

Some members of the editors' society have objected to the invitation extended by officers of ASNE but George W. Healy, Jr., editor of the New Orleans Times-Picayune and president of the group, steadfastly maintains nothing improper was done.

SEARCHED	INDEXED
SERIALIZED	FILED

b3
b6
b7C
b7E



SMILING STATESMEN—Fidel Castro and Acting Secretary of State Christian Herter pose cheerfully at their luncheon meeting at the Statler Hotel today.—Star Staff Photo by Paul Schmick.

SEARCHED		INDEXED	
SERIALIZED		FILED	

b3
b6
b7C
b7E



CASTRO AT THE CAPITOL—Fidel Castro waves from the Capitol steps after a surprise visit to Senate Foreign Relations Committee. The 32-year-old Cuban leader chatted with committee members on the unscheduled stop.—AP Wirephoto.

U. S. Press Defended On Batista Coverage

By GEORGE KOLLAND
staff writer

Frank Storz, general manager of the Associated Press, today defended the record of the American press in reporting brutalities during the Batista regime in Cuba.

"It is not a fact that newspapermen in this country were completely ignorant of the Batista regime," he told the press association's leading editors.

"If anyone thought Batista was sweetness and light in the Batista regime," Storz added, "they did not read their newspapers."

The press association officials gave his views on reporting from Cuba during the administration of ousted President Fulgencio Batista in a panel discussion at the convention of the American Society of Newspaper Editors at the Statler-Hilton Hotel.

The discussion over whether the press associations and newspapers had adequately reported events in Cuba over the last

few years afforded a backdrop for the appearance before the editors in the afternoon of Fidel Castro, Prime Minister of Cuba's revolutionary government.

Mr. Storz said accusations that brutalities of the Batista regime had not been reported came up as a "backwash" of criticism of the Batista government after the execution of soldiers and police officials identified with the Batista regime.

His discussion was set off by a question on why editors were so unaware of "the extraordinary brutality" of the Batista Government, assuming the reports of such brutality were correct.

Both Mr. Storz and Frank Bartholomew, president and general manager of United Press International, another

See EDITORS, Page A-5

THE EVENING STAR
 Page A1 Date 4/17/59

[REDACTED]	
SERIALIZED	INDEXED
APR 17 1959	
[REDACTED]	

b
b
b
b

EDITORS

Batista Terrorism Bared, Newsmen Say

Continued From First Page
panelist, cited the difficulties of getting news out through censorship of the Batista regime. Moreover, Mr. Starzel said, the brutality "was done in the dark of night, in alleyways, prisons and dungeons."

But he said he had a survey made of press dispatches from Cuba and exhibited a large sheet of the findings. They were, he added, "very thoroughly peppered with claims of terrorism."

Mr. Starzel blamed the charges that brutalities of the Batista regime were not fully reported as counter-propaganda "largely propagated by one organization that is not wholly without its partisan interest."

He declined to identify the organization. When a member said he thought the organization should be named, Mr. Starzel said he would stand "on personal privilege in not getting the Associated Press involved in controversy."

Transmission a Problem

Mr. Bartholomew told the editors there were many problems in covering events in Cuba and that it was "an extremely difficult task" to bring the story into focus. In some instances, he said, it was necessary to bring the UPI correspondent from Havana to Miami to file a story. He added that the story often was carried under a New York deadline to protect the correspondent.

Another participant in the panel discussion was Walton A. Cole, deputy general manager of Reuters, a European news service, who said that while the big news in the near future will be centered in Europe, editors also should keep an eye on Asia, where several situations might explode into big news stories.

Press New Demands

The press officials say no revolutionary changes in the assembling and transmission of news but they emphasized that their work in the years ahead will require higher degrees of skill and more specialists trained in reporting world events.

Mr. Bartholomew suggested that editors would find it would "pay dividends in the national interest" for greater use of dispatches from Latin America.

At another panel discussion yesterday afternoon the editors sought unsuccessfully to get some glimmering of news on the possible Democratic and Republican presidential candidates in 1960.

Guests on the panel were Democratic National Chairman Paul M. Butler and Senator Morton of Kentucky, making his first public appearance as the new chairman of the Republican National Committee.

Appearing with them were Senators Mansfield of Montana and Muskie of Maine, for the Democrats, and Goldwater of Arizona and Scott of Pennsylvania, for the Republicans.

It was billed as "The Smoke-Filled Room," but the political professionals exhibited a pervading reluctance to discuss possible candidates.

Senator Morton was asked, for example, if he considered Gov. Nelson Rockefeller of New York as "an active candidate" for the presidency.

The Republican leader said "I frankly don't know" and then, after fumbling a bit, he added, "I know a lot of people in this country want him to be a candidate."

Speaks Out on Rights

Mr. Butler was outspoken on another touchy matter—the issue of civil rights.

He predicted that the party's 1960 platform will stand behind the Supreme Court's school desegregation decision and oppose massive resistance.

His comments were brought out by a question on whether he no longer considered the South important to the Democratic Party. Mr. Butler emphasized that he had never said, nor implied that the Democratic Party was not interested in keeping the South within its fold and added:

"I believe the party must be candid and honest with the American people as to where it stands. I know of no problem more important than our ability to live together regardless of race or national origin."

Page 46 Date 4/17/59

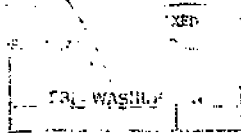

The Washington Merry-Go-Round

Castro's Stand On Russia Cited

By Drew Pearson

THE WASH. POST & TIMES HERALD
Page 3, 4. Date 4/17/59

THE MAN responsible for getting Fidel Castro of Cuba to come to the United States so both the American Society of Newspaper Editors and the American people can get better acquainted with him is George Healy, editor of the New Orleans Times-Picayune.



This is in contrast to the New York Times, which built Castro up but has reported little recently of the hectic gyrations and amazing speeches by the young man who is ruling a country vital, geographically, to the United States.

The most important thing to know about Castro is exactly where he stands in regard to Soviet Russia. We must praise his honesty-in-government reforms and be sympathetic with his social reforms, but with Cuba located only a few minutes' flight from the United States, across the approaches to the Panama Canal, and the chief source of our sugar supply, the basic question is:

Where does Castro stand regarding Russia?

Where does he stand also regarding the Guantanamo Naval Base, our most important in the Caribbean, which already his supporters claim should revert to Cuba?

'Neutral' Cuba?

Insight into Castro's position on Russia was first revealed on March 23 when Jose Padierna, former President of Costa Rica and a staunch supporter of Castro, made a speech at a big labor rally in Havana. Padierna was hailed in Havana as a hero. He had battled for years against the dictators of the Caribbean, had lined up with Fidel Castro, rejoiced over his victory. So he was invited to Havana to speak at the city's largest labor rally, how- ever, he said:

"We have been doing some great things for democracy in Latin America, but it's time we remembered that our friend, the United States, faces a grave problem with Soviet Russia and that we aligned ourselves in a solid front in the Western Hemisphere against communism."

At this point a Cuban labor leader leaped to his feet,

seized the microphone and shouted: "This does not represent the real thinking of Latin Americans."

Figueres was allowed to finish, whereupon Castro sorrowfully rebuked him.

"I don't like to differ with my good friend from Costa Rica," he said, "but in any competition between the United States and Soviet Russia we are not taking sides. Should there be war between the United States and Russia, Cuba would be neutral."

These remarks were buried in the New York Times.

Criticism Unwelcome

On April 3 he delivered a four-hour telecast in which he really took off his gloves against his old friend, ex-President Figueres of Costa Rica. Figueres had backed Castro to the hilt when he was the underdog, but made the mistake of thinking his friend could take criticism.

Castro fired back:

"Figueres' statements are those of a bad friend, a bad democrat and a bad revolutionist. I resent his intrigue when he said our attitude was influenced by communism."

"Instead of coming here as a leader of another small country to encourage the defense of our dignity against unjustified propagandistic attacks, he came on the side of a powerful nation, hurting the interests of a little nation. This is not correct and does not have any sense."

Castro Young, Naive

To understand how naive Castro is and how much he has to learn about Cuba's relations with the outside world, take a look at his recent statement that he expected to increase the Cuban sugar quota on his trip to the United States.

What he obviously didn't know was that the sugar quotas in this country are fixed by law and are revised only once a year, and then only by Congress. Neither the State Department nor the White House can change them.

Castro is young, and had been busy fighting in the mountains of eastern Cuba, so didn't know this. However, as a Prime Minister of a country where sugar is king, it would seem important to educate himself immediately on the commodity which is the economic life-blood of his island.

(Copyright) 1959. Ben S. ... Inc.

SEARCHED	INDEXED
SERIALIZED	FILED

b3
b6
b7C
b7E

Open Letter to Castro

By Roscoe Drummond

Vision and Bravery Required for Tasks Ahead

DR. FIDEL CASTRO,
Prime Minister of Cuba
Washington, D. C.
Dear Mr. Prime Minister:
You are the
welcome guest
in the United
States of the
American So-
ciety of News-
paper Edi-
tors. We are
pleased that
you are here.
We are eager
to meet you at
first hand, to
talk with you at first hand,
to listen, to question—and
even to talk back.



people of Cuba to achieve
their independence, their
liberty, and their democracy.
You know, Dr. Castro, what
it is that you will and purpose
and you have an esteemed
United States correspondent,
Jules Dubois of the Chicago
Tribune as a witness who re-
ports that you will and pur-
pose good.

BUT DO NOT read anti-
Cuban or pro-dictatorship or
anti-Castro motives into the
honest anxieties which many
Americans feel. They arise
inevitably when we read of
the executions and wonder if
'revolutionary justice' isn't
getting out of hand, when we
see that the noted editor of
the independent El Mundo is
being jailed first and investi-
gated afterward, when we
feel the sharp, virtuous lash
of your own criticism of the
United States.

It is true that few Ameri-
cans appreciate the torture and
murder practiced by some of
the Batista henchmen and it
is certainly true that some
American diplomats made it
appear that we not only recog-
nized the Batista dictator-
ship—but liked it.

We never did like it and
today, Dr. Castro, you are
among people who don't like
dictatorship and never will.

We know that the govern-
ment which is in power in
Cuba today—in power by
force of revolutionary arms—
is not a military junta and

was not a "palace" revolt. It
is a revolution of the Cuban
people, supported by most
of the Cuban people, approved
by most of the Cuban People.
This means that you, Dr.
Castro, young as you are,
have pressing about you, as
did George Washington on
the eve of his inauguration
in 1789—much of the aura of
father and patriarch. Wash-
ington was the object of mas-
sive, popular adulation and
he could have made himself
a dictator if he had not
vigorously resisted. You are
the object of massive popular
adulation. To avoid its con-
sequences you will, I suspect,
not only have to will and pur-
pose democratic government,
but also fight off your adu-
lators who will want you to
solve their problems by con-
stantly delaying and putting
off democratic institutions,
rather than the more difficult
way of the ballot box.

If you are determined to
build constitutional, demo-
cratic government in Cuba,
with freedom of the press,
freedom of assembly and
freedom of religion, I say to
you, Dr. Castro, you are
among friends.

(Copyright, 1959, New York Herald
Tribune, Inc.)

THE WASH. POST & TIMES HERALD
Page A23 Date 4/17/59

Your hosts—the A.S.N.E.—
will pass no resolution prais-
ing you or criticizing you.
Our consensus would un-
doubtedly be friendly. It
would also be reserved be-
cause you know and we know
that your greatest test lies
ahead, that the greatest test
is not winning the revolution
for the Cuban people but
winning the Cuban people to
democracy.
But American newspapers
do not wait and do not let
any organization, even their
own, speak for them. Each
speaks for itself and in this
diversity the American press
—free to criticize its friends,
its enemies, and each other—
can, we believe, best do its
part in safeguarding those in-
dividual liberties without
which democratic government
cannot function.

HAVE NO doubt about it,
the American people and the
American press hate dictat-
orship whether it bears the
stamp of a Mussolini, a Hitler,
a Khrushchev, or a Batista.
We realize that you had no
alternative but to fight dicta-
torship with revolution. It
was the only means open to
you. We know from our sym-
phony that we were able to
gain our independence and
our liberty only by the use of
force.

It has taken great bravery,
Dr. Castro, to fight the anti-
communist forces. We take
proud note of your bravery to
do anything necessary to
establish constitutional, dem-
ocratic government in the
place. One of the most diffi-
cult will be to keep clear of
the cloaking support of the
Communists who will tempt
you and try to use you for
their own design—and that
design is another Cuban dic-
tatorship more suffocating
and crushing than anything
before.

We American editors and
writers earnestly want the

SEARCHED [] INDEXED []
SERIALIZED [] FILED []
APR 17 1959
[]

b3
b6
b7C
b7E

A14

Editors to Let Video Cover Castro's Speech

United Press International

Television broadcasters won their fight yesterday to cover a speech by Cuban Premier Fidel Castro today before the American Society of Newspaper Editors meeting here.

The ASNE reversed an earlier ban on telecasting of the Castro speech after radio-TV leaders accused the society of undermining its own campaign for free access to the news.

Alfred Friendly, managing editor of the Washington Post and chairman of the ASNE press relations committee, said the change was made by ASNE President George W. Healy Jr. after conferences with broadcasting representatives.

Television networks will be allowed to film the Castro speech for later use. There will be no live television.

Radio broadcasters were offered the opportunity to air the speech live, but none asked to do so.

The original ASNE decision was that TV cameramen would be restricted to taking pictures of Castro in an anteroom outside the convention chamber.

Healy indicated earlier that newspaper editors were irked by what they regarded as an ultimatum from broadcasting networks to the effect that they would not cover the ASNE's annual banquet Saturday night, at which Vice President Richard M. Nixon will speak, unless they were allowed to cover the Castro speech.

[Redacted]

SEARCHED	INDEXED
SERIALIZED	FILED
APR 17 1959	

[Redacted]

b3
b6
b7C
b7E



Prime Minister Fidel Castro of Cuba holds Sherry Robin Hayes, 18 months, daughter of Mr. and Mrs. Leon Hayes of 2327 15th st. n.w., while making a tour of Meridian Hill Park near dusk last night. Castro is surrounded by autograph-seekers.

A Lesson for the Future, Castro Calls Post-Revolution Cuban Executions

By Phil Casey
Staff Reporter
Cuban Prime Minister Fidel Castro said yesterday the executions in Cuba are "a lesson for the future."

The bearded, 32-year-old revolutionary said in an interview at the Cuban Embassy that the people's faith that the Batista regime leaders would be punished legally prevented great bloodshed in the final days of the revolt. The interview took place at the foot of the long, marble staircase in the red-carpeted embassy foyer, just as the weary Castro was hoping to escape to his room for a brief rest. Through the day, he had been interviewed almost endlessly, mostly by the Spanish press, lunched at the Statler hotel with Acting Secretary of State Christian Herter, and returned to the Embassy for more interviews and for a walk.

At the luncheon, he told Acting Secretary Herter and others that he hoped the people of the United States would one day "recognize the whole truth of the revolutionary struggle" and said he saw no reason why relations between Cuba and the United States should not be "the best," and he and Herter exchanged assurances of friendship.

"The executions are a lesson that never again can the people in power rob and torture and murder and hide their crimes and escape punishment," Castro said, in the wayward English he had practiced much of the night.

"The world is against us now. Well, the world was not there. The world does not

know what happened. Thousands of women are wearing black in Cuba because of Batista. Twenty thousand people were murdered. Bodies pushed into rivers, the killings hidden."

"The newspapers say those being executed were Batista's friends. They were not only that. They were assassins."

"Only those who had political power and abused that power are being executed," Castro said. "Most of the criminals, thousands, have been put into jail. The executions would not have gone on this long if we had not acted with justice, with trials and proof. Why are

Four Cuban fugitives hijacked airliner, force it to fly to Miami. Pictures, Page A3.

we criticized? Because we do this openly, not in secret. We have nothing to hide.

"These men robbed and killed the people," he exclaimed, gesturing with a big cigar. "Since when are robbery and murder political crimes? When and where were they ever? These people are criminals."

"Those who escaped should be sent back. They are not political criminals. They are criminals, devoid of conscience. And the worst thing of all was the abuse of their power."

Castro, smiling and at ease most of the day, though perpetually surrounded by a herd of Spanish and American reporters and photographers, was dressed in his usual off-hand manner. The collar of his olive green shirt was open. He kept his Army hat on, and

he carried a great big Cuban cigar that kept going out.

When he arrived at the Embassy, at 2830 18th st. n.w., Wednesday night, he showed the same disdain for security regulations that he had at the airport.

Esther Guzman, Embassy attaché, pointed to a crowd of about 150 persons—both Cuban and American, and apparently not unfriendly—across the street. She suggested he go up to the balcony and wave.

"I'm no man on a balcony," Castro snorted, and took off, dodging nimbly through the traffic, to meet the people.

Returning to the Embassy, where a crowd of about 200, all cleared by security guards, awaited him, he went to his third-floor room, flopped on a bed fully clothed, and announced, "I'm tired. Tired."

And then he began practicing English with one of his party. He was awakened after only a few hours of sleep, at 6:30 a. m., for some more English practice.

"He just rolled over," an Embassy worker said, "and went back to sleep."

Up a few hours later, Castro, whose hair isn't as wild as that of some of his followers, found out he needed a comb and a toothbrush, and an aide was dispatched to the drugstore.

There were 34 pickets at the White House Wednesday and about 20 at the Statler yesterday. Rafael del Pino, erstwhile friend of Castro and now his enemy, denied anyone had been paid to picket but several said they had and that others had been paid, too.

One picket said he had been paid \$15. Another said he had been paid \$35 for picketing at the White House and at the airport.

b3
b6
b7C
b7E

SEARCHED	INDEXED
SERIALIZED	FILED

Red Label Is Rejected By Castro

Cuban 'Guarantees' Investments; Free Press Is Praised

'Guarantees' Investments Of Americans

By Edward T. Follard
Staff Reporter

Fidel Castro, Prime Minister of Cuba, wrestled bravely with the English language for 2 hours and 15 minutes before the American Society of Newspaper Editors here yesterday.

To judge from the applause, he scored a victory in the public-relations field.

The erstwhile revolutionary, an idol in Cuba since he smashed the Batista regime, told 1000 editors gathered in the Statler Hotel that "we are not Communists."

Anti-Castro pickets, who appeared near the hotel along with pro-Castro pickets, carried signs alleging that the Cuban leader had Red affiliations.

One of the anti-Castro pickets said they had been hired in New York and were being paid \$17 a day by Rafael Trujillo Molina, dictator of the Dominican Republic, where former Cuban President Fulgencio Batista is in exile.

Prime Minister Castro, a big, broad-shouldered fellow of 32 in an olive-green uniform open at the throat beneath his beard, and with a star on each shoulder, didn't talk like a Communist or a dictator.

He spoke up for a free press and for all the other freedoms associated with true democracy. He welcomed American industrial investment in Cuba. See EDITORS, A10, Col. 2

EDITORS—From Page 1

'We Aren't Communists,' Castro Tells Editors

and guaranteed that it would be safe.

"Ask me all the questions you want," he told the editors. "I am here to answer them."

Naturally, he was asked about the wholesale executions of Batista men, which shocked millions of Americans who earlier had cheered his victory.

Castro insisted that his Government had not executed men simply because they were Batista followers, but had put to death only "war criminals."

He said that Americans could better understand what had happened if they remembered what had been done to Nazi war criminals, evidently an allusion to the Nuremberg trials and the aftermath.

In answering an editor's question, he declined to say that he was ready to proclaim a general amnesty for the future.

'Door Open' to Cuba, He Says

The Cuban leader, in talking about his country's financial difficulties, gave the editors a lighthearted spiel on the glories of the Pearl of the Antilles from a tourist standpoint.

He suggested that 10 million Americans ought to go to Cuba and spend \$100 each. It is "wonderful" there in summer and winter, he went on, picturing the delights of fishing, racing and dancing.

"Go to Cuba," he said. "We have the door open. No other place in the world would you find happier people, people full of hope and optimism. Go, and you will have a good time, and at the same time you help our country."

Occasionally, Castro would grope for an English word, give up, and turn to an interpreter at his left for help. But he knew the word "money" well, and used it several times.

Denies Money Was Goal

"It is possible many people believed we were coming here for money," he said. "I wish to explain that we didn't come here for money."

"You should not think of our country as beggar. The Cuban people are hard working. They are not lazy."

He explained that proportionately Cuba now has more unemployed than the United States had in the Great Depression. He pointed out, too, that Cuba buys more from the United States than this country buys from Cuba.

"What we want from the United States," he continued, "is a just trade treaty so that we will get from the United States the same money the United States gets from us. We want just treatment in economical matters."

The Prime Minister was applauded vigorously when he proclaimed his belief in a free press, saying:

"The first thing dictators do is to finish the free press and establish censorship. There is no doubt that the free press is the first enemy of dictatorship."

He said, in reply to questions, that he was content to have the United States Navy continue its base at Guantanamo Bay; that Cuba will continue to give sanctuary to Latin Americans who hope to overthrow dictatorships in their own countries, but will observe a policy of nonintervention in the affairs of other nations, and that it will maintain its membership in the 21-nation Western Hemisphere Defense Alliance.

However, he declined to answer directly a question as to whether Cuba would remain neutral in case of war between the West and the Soviet Union.

At a morning session of the ASNE, the editors listened to a discussion on "Where are our great press associations going?" Basil L. (Stuffy) Walter of the Chicago Daily News was moderator, and the panelists were Frank Bartholomew of the United Press International, Walton A. Cole of Reuters, and Frank Starzel of the Associated Press.

None of the three wire-service men looked for any startling changes in their field in the years ahead.

Starzel, in reply to an editor's question, said it was not a fact that the AP did not know what was going on in Cuba during the Batista era, and added that the AP's report was peppered with claims of terrorism during that period.

Writer Protected

Bartholomew said that it had been necessary for the UPI to send its Havana correspondent to Miami to telephone New York with stories. The stories, he said, were put under a New York dateline to protect the correspondent.

Coverage of international news by North American newspapers was discussed later on, with Lester Markel of the New York Times as moderator. The panelists were Robert C. Nelson of the Portland Oregonian, John F. Dille Jr., of the Elbert (Ind.) Truth, J. Montgomery Curtis of the American Press Institute, and Alvin Faulkner of the London Daily News.

He noted, however, that the needed among nations to bring about better understanding and peace.

The panelists agreed that the American press was on the whole doing a good job in the handling of foreign news.

Castro's First Round

Fidel Castro faced a formidable challenge yesterday in his appearance before the Nation's editors, and on the whole we think he acquitted himself well. The confrontation itself was memorable; seldom has the American Society of Newspaper Editors heard so unusual a head of government as the tireless young Prime Minister of Cuba. Clothed in battle dress, speaking for more than two hours in an unfamiliar tongue, Castro broke most of the rules of diplomatic oratory and yet somehow avoided disaster. He communicated something of the passion which he feels for his cause, as well as the ideals which inspired his extraordinary revolt against an entrenched dictator. He was eloquent in defense of his regime's record, although on occasion he seemed on the verge of haranguing his listeners.

In substance, what he had to say was not new. It was important for an American audience to hear him assert that his movement was not Communist and that the fundamental goals he seeks are full political rights and social justice. Yet he was also unsatisfyingly fuzzy in his view of Cuba's defense responsibilities in an East-West conflict, in his assurance of "nonintervention" among his neighbors and in his ideas of what constitutes justice.

Castro reiterated time and again that the people of Cuba were with his regime and he seemed to imply that absolute majorities mean absolute right. But no less important in the democratic credo is the Jeffersonian maxim that a majority must also respect the rights of minority, because transient opinion can impose a tyranny no less harsh than that of a dictator. Other revolutions, fought for the highest ideals, have tarnished their records by equating revenge with justice and purges with reform.

Perhaps the most important result of Castro's talk was that he made his listeners feel something of the psychology of a smaller neighbor who must depend on a giant who often seems maddeningly indifferent and unforgivably ill-informed. It is true that the United States for years impinged on the sovereignty of Cuba through the Platt Amendment which for three decades gave this country a veto over certain of the island's internal affairs. It is also a fair criticism that decisions on sugar imports—vital to Cuba's economic health—are often taken more with a view to this country's interest than of Cuba's.

That is why it is so important that a measure of understanding exist between Washington and Havana. Given some temperance and understanding on both sides, Castro's visit may yet contribute to that end.

PAGE A 8
WASHINGTON POST
4/18/59

SEARCHED _____ INDEXED _____
SERIALIZED _____ FILED _____
APR 18 1959

b3
b6
b7C
b7E

Fidel and the Editors

FIDEL CASTRO'S beguiling combination of inspiration, ham, romantically whiskered good looks, sincerity of purpose and political astuteness were turned on the nation's top editors yesterday, at their own request, and we'd say that, net, the result was good both for Cuba and the United States.

After the revolution, Castro had complained that our country's newspapers had ignored or had unfairly treated Cuba's recent history.

So the American Society of Newspaper Editors then invited the controversial and colorful prime minister to come here and tell them his side.

He took them up, and yesterday, in stumbling but effective English, he pleaded the cause of the new Cuba.

It is safe to say that there are fewer carping critics today because he did so.

Net, he made an excellent impression.

He replied to all questions.

He ducked a few.

He explained with conviction and considerable power the plight of the rural Cuban, whose hopes for a better life the revolution espoused.

"How would your country do," asked Castro, "if one in 8 or 10 men was employed, or if able-bodied farm workers had only three months' work each year?"

He told of the need for jobs, for machines, for more native production, and the hope that now these things were a bit nearer, now that the preceding corrupt regime was gone.

He slid away from an important question based on one of his own speeches in Havana where he had suggested that in the struggle between the free Western world and the communist powers, Cuba's course could be neutral. The questioner, Frank Ahlgren, editor of The Memphis Commercial Appeal, had reminded Castro that Cuba was a signatory to the Defense of the Hemisphere pact.

Did Castro intend to repudiate this pact? asked Mr. Ahlgren.

Castro explained that he had merely said that Cuba had no hole to hide in, in a modern war, and that Cuba had not repudiated the pact.

It is true that he did make the "no hole to hide in" remark in the same Havana speech. But he also made the remark about neutrality. Yesterday he failed to satisfactorily explain that remark. Nor did he say that he did not intend to repudiate the pact. Perhaps language difficulties were to blame. If so, we'd like him to clarify.

He was asked if Batista officials—specifically Dr. Joachim Martinez-Saenz, former president of the National Bank—would get civil trials instead of military ones.

Castro reasonably explained how it was difficult to give persons civil trials when the whole judiciary, which has been so corrupt, had been completely dismantled. He explained how the ordinary processes of law are being re-established, but he never got around to saying whether or not the men accused of civil crimes would get civil trials.

He was asked about the communists' claim that the Communist Party had played a decisive role in the revolution.

Castro replied that all classes—lower, middle and upper—had joined in the revolution led by the "July 26 Movement" and we know that is the truth.

But he didn't repudiate the communists, nor did he delineate their role, either during or after the revolution; a role that right now is a lot greater than most citizens of the free world like to see.

Nevertheless, it would be a mistake to turn the revolution over to them.

Nevertheless, we're convinced that Castro is right when he says that the essential motivation for the revolution was a passionate determination to win freedom, decency, honesty in government, and justice. These are needs that every citizen of the United States understand and support, and that as long as they are the revolutionary government's aims, the generosity and sympathy of the Americans are Cuba's for the asking.

Wash. Post - 04-18-59

b3
b6
b7C
b7E

SEARCHED	INDEXED
SERIALIZED	FILED
APR 18 1959	

Castro Continues Visit; Denies Links to Reds

Prime Minister Fidel Castro, continuing his unofficial goodwill visit to the United States, turned attention today to a reception for the diplomatic corps and high Government officials in the hope of winning friends for his provisional government in Cuba.

The reception will begin at 5 o'clock at the Cuban Embassy. Aides of the uninhibited young revolutionist appeared satisfied with his performance in his first major test here—a tough question-and-answer session with prominent United States editors. During the meeting he denied being communist and defended his execution of "war criminals."

Views Vary

Many members of the American Society of Newspaper Editors, who invited him to their convention here, agreed he made a good impression. Some expressed disappointment, however, in his failure to respond directly to most questions.

Some 200 anti-Castro pickets paraded near the Statler-Hilton Hotel where he spoke. Mr. Castro did not see them. They and their anti-Castro banners were gone by the time he left the hotel.

Smaller pro-Castro groups also were in the area. There were no clashes. A heavy police guard was thrown around the hotel and its vicinity.

The Prime Minister said he hopes to ward off communism in Cuba by wiping out poverty and hunger.

He was asked if the Cuban Communist Party played an active or decisive role in the revolution which overthrew dictator Fulgencio Batista. Avoiding direct comment, he said this was a revolution of all classes, a fight of the people of Cuba.

Smathers Issues Charge

But Senator Smathers, Democrat of Florida, issued a statement in which he said the Castro government is "peppered" with Communists. He said Mr. Castro must learn that he cannot "play ball" with Communists. The Senator made the observation in urging the Organization of American States to form a special police force to prevent invasions of Latin American countries.

At the editors meeting, Mr. Castro spoke out strongly against dictators and for a free press.

He pleaded for understanding of the economic plight of Cuba, saying the deterioration of the sugar market, plus high United States tariff barriers had resulted in seriously adverse conditions.

Opening the question-and-answer period, George W. Healy, Jr., of the New Orleans Times-Picayune, president of the society, asked:

"Do you believe the state should be the servant or the master of the people?"

Mr. Castro answered: "Of course, I sincerely believe the state should serve the people. Absolutely."

The first question from the floor touched on the reports that exiles from other Latin American countries who have found a haven in Cuba are plotting new revolutionary movements, particularly against the Trujillo regime of the Dominican Republic. The question was whether Mr. Castro intended to give aid and comfort to these exiles in violation of the principle of non-intervention.

Non-Intervention Principle

Mr. Castro, once an exile himself, said there were many exiles in Cuba and "in our country they have hospitality." After talking at length about the exile's natural yearning to return home, the Prime Minister said, "Our principle of relations with other countries is the principle of non-intervention."

Mr. Castro suggested that if other democratic American States should join in demanding free elections in the dictator countries "that would be a solution."

Another editor noted that Mr. Castro has been reported as saying Cuba would remain neutral in the event of war between the Western world and the Communists and asked if the Prime Minister would adhere to the mutual American defense pact that Cuba has signed.

He replied that what he said was that Cuba, a poor country, had no defenses and sought protection. When the question was repeated, the Cuban leader remarked that "we have nothing else" and "we have kept our agreement."

Defends Regime

Several questions provoked a spirited defense by the Prime Minister of the quality of justice meted out by the provisional government.

One editor said it had been reported that a high civilian official of the Batista government had been arrested. He inquired if this official would be tried by military or civilian court.

In reply, Mr. Castro said only those Batista officials accused of war crimes were being tried in military courts. He also said it had been necessary to reorganize the judiciary and this took time. The civil judicial procedure, the Cuban leader assured the editors, would be re-established within a few weeks, including the right of habeas corpus for a defendant.

Cites Batista Brutalities

Another editor said a great deal had been heard about executions and asked: "Now that your government is established, do you not think it is time now or in the near future to proclaim a general amnesty?"

The bearded leader, waving his arms, launched into a recital of some of the brutalities of the Batista regime as well as a defense of the execution of Batista followers that have been carried out by his government.

Twenty thousand people, Mr. Castro said, had been "tortured and assassinated" in seven years. He said the American people, because of censorship imposed by the Batista government, did not know this and had no idea of the tyranny of the overthrown regime.

He said people were roused out of their homes at 2 or 3 o'clock in the morning and disappeared never to be seen again. "You have no idea what occurred," Mr. Castro said, "but our people know."

Recalls Promise of Justice

He said that during the revolution he had promised justice to the Cuban people many times and that "the people had faith in that justice."

The executions that have been carried out, Mr. Castro said, have "fulfilled the requirements for justice."

The justice dispensed by the revolutionary government, he indicated, would be a lesson to future soldiers and police officials that people should not be tortured and assassinated for political reasons.

The Evening Star
 April 4-18-59

SEARCHED [] INDEXED []
 SERIALIZED [] FILED []
 APR 13 1959
 FBI - WASHINGTON

b3
 b6
 b7
 b7

Trade Needed, Cuban Declares

By Phil Casey
Staff Reporter

A Cuban finance official said yesterday his country wants "trade, not aid" to improve itself economically.

Ernesto Betancourt, manager of Cuba's Bank of Foreign Trade, who has been helping Prime Minister Fidel Castro practice his English, said Cuba hopes that "tourism, tobacco and sugar" will lift Cuba out of the economic doldrums.

"We can't go too fast in purchasing industrial machinery," he said. "First, we must earn the money."

Cuban Finance Minister Rulo Lopez Frescolet said much the same thing, pointing out that merely "lending money has never solved anything" for underdeveloped countries.

While the finance officials and others roamed about the Embassy in apparent business, the 32-year-old, Prime Minister, who stayed up most of the night touring the town and eating Chinese food, remained in his room and in his pajamas.

Castro rose late and reportedly went to work immediately after breakfast, taking time out only to receive a few visitors.

A couple of them were Castros. They were Jeff, 9, and Jack, 5, of 146 Wayne place, sons of Mr. and Mrs. Manuel Castro, no relation to the Prime Minister.

Also waiting to see Castro and carrying a foot-long cigar as bait was Robert L. Long Jr., 14, of 7927 Chicago ave., Silver Spring, Robert, who writes poetry for the Takoma Park Junior High School paper Pegasus, is covering Castro's visit and plans to write a story about it.

The unpredictable Cuban



By Norman Dilcock, Staff Photographer

Russian Ambassador Mikhail A. Menshikov, left, exchanges greetings with Cuban Ambassador Ernesto Diniego and Cuban Prime

Minister Fidel Castro, right, at a reception held last night at the Cuban Embassy, 2630 16th st. nw.

who was supposed to be bedded down early Friday night, suddenly decided to take a tour. Accompanied by surprised security guards, he rode by the Lincoln and Jefferson Memorials and around Hains Point and then stopped at the Peking Restaurant, 711 13th st. nw.

Last night an Embassy reception brought out the Prime

Minister in white shirt and dark tie.

Swirling about him in the Cuban Embassy were Ambassadors, other diplomats and their ladies. Defense Secretary Neil H. McElroy was there with his daughter, topping the United States' representation. Russian Ambassador Mikhail A. Menshikov showed up, and so did Samuel C. Waugh, pres-

ident of the Export-Import Bank.

At the reception, Castro presented medals to nine American newspapermen who interviewed him in his mountain stronghold while he was leading the revolution. Among those honored but not present was Karl Meyer of the Washington Post.

The Washington post
and times Herald,
P - 17, Sec-A

SEARCHED	INDEXED
SERIALIZED	FILED
1959 9 10 9	
FBI - WASHINGTON	

b3
b6
b7C
b7E

Observers Believe Castro Is Seeking U. S. Trade for Cuba, Not Aid

By JOHN V. HORNER
Star Staff Writer

Trade, rather than aid, is the subject being stressed by Prime Minister Castro in his discussions here.

This is the report today of persons who have had op-

INTERPRETIVE REPORT

portunities to confer privately with the visiting Cuban revolutionary leader.

One high-ranking official who talked at length with Mr. Castro said no mention was made of financial assistance but the Prime Minister is obviously concerned by Cuba's economic difficulties and hopes to stimulate the sale of such products as sugar.

Before leaving Havana, Mr. Castro was quoted as saying he hoped, during the visit here, to arrange for an increase in the Cuban sugar quota. But this cannot be done because quotas are fixed by law and no changes could be made except by action of Congress.

Economy Deteriorating

The Cuban economy has been deteriorating badly for several years, due in large part to a decline in sugar prices. Another factor was the heavy expenditure of the Batista regime for arms.

Since Mr. Castro overthrew the Batista dictatorship on January 1, the downward trend



CASTRO OBLIGES—Fidel Castro signs his autograph for Miss Mary Jo Baker yesterday without relinquishing his hold on the cigar. The Cuban Prime Minister was stopped frequently on a walk in Washington and always obliged with his autograph. —AP Photo.

newspapers in Cuba...

<p>529.95 Value New 1959 STEREO HI-FI TWIN Ensemble Phonograph, 4-Speed Auto. changer, 4-speaker system</p> <p>3199.95 Mr. List 1958 ZENITH HI-FI Phone Console, 4-Speed auto. changer, 3-speaker, cherry cabinet</p> <p>339.95 Mr. List ADMIRAL 1958 HI-FI has controls</p>	<p>5199.95 Mr. List ADMIRAL 27" Top tuning table television New 110 degree picture tube</p> <p>539.95 Mr. List 1958 PHICO 27" 3-speaker, SWIRL console 14" New 110 degree illuminated picture tube, filter, glass</p> <p>Special New 1959 ADMIRAL TV New 17" Portable, Shimlone TV New</p>	<p>529.95 Mr. List RCA WHIRL Automatic WASHES, 5-washer temp. control, hot filter</p> <p>539.95 Mr. List RCA WHIRL Automatic WASHES, 5-washer temp. control, hot filter</p> <p>529.95 Mr. List NORGE De Automatic WASHER, 2-washer, temperature control</p>
--	--	---

TELEVISION

AUTOMATIC WASHERS

SEARCHED.....
SERIALIZED.....
APR 20 1959
FBI - WASHINGTON

b3
b6
b7C
b7E

Observers Believe Castro Is Seeking U. S. Trade for Cuba, Not Aid

By JOHN V. HORNER
Star Staff Writer

Trade, rather than aid, is the subject being stressed by Prime Minister Castro in his discussions here.

This is the report today of persons who have had op-

INTERPRETIVE REPORT

portunities to confer privately with the visiting Cuban revolutionary leader.

One high-ranking official who talked at length with Mr. Castro said no mention was made of financial assistance but the Prime Minister is obviously concerned by Cuba's economic difficulties and hopes to stimulate the sale of such products as sugar.

Before leaving Havana, Mr. Castro was quoted as saying he hoped, during the visit here, to arrange for an increase in the Cuban sugar quota. But this cannot be done because quotas are fixed by law and no changes could be made except by action of Congress.

Economy Deteriorating

The Cuban economy has been deteriorating badly for several years, due in large part to a decline in sugar prices. Another factor was the heavy expenditure of the Batista regime for arms.

Since Mr. Castro overthrew the Batista dictatorship on January 1, the downward trend has continued. Tourism has fallen off sharply and investors worried about the political and economic uncertainties have withdrawn large sums of money. So far Mr. Castro has made the most favorable impression while relaxed in informal conversation. In such situations he appears shy, talks in a soft, low voice. There is certainly no impression of a cold, hard revolutionary, said one observer.

Sometimes Irritable

But in the midst of shoving crowds and inquiring reporters he sometimes appears irritable. In the lobby of the Cuban Embassy yesterday morning, a reporter asked him, in the most courteous way, whether the



CASTRO OBLIGES—Fidel Castro signs his autograph for Miss Mary Jo Bakes yesterday without relinquishing his hold on the cigar. The Cuban Prime Minister was stopped frequently on a walk in Washington and always obliged with his autograph.—AP Photo.

newspapers in Cuba were free to criticize his government.

Mr. Castro bristled. "Every newspaperman in the United States is invited to come to Cuba and see for himself," he replied sharply. "What puzzles me is that in this country such a question should be asked."

With that, the Prime Minister took one last hard look at the reporter, snapped his fingers and marched out of the front door. This ended an impromptu press conference.

Expresses Thanks

A few minutes later, Mr. Castro was exchanging pleasant remarks with Acting Secretary of State Herter and other high ranking officials at a luncheon given for him at the Staller-Hilton Hotel.

The Prime Minister expressed thanks for the welcome and said he was glad to accept the honor on behalf of the Cuban people.

Earlier, Mr. Herter had spoken of the struggle in Cuba which he said cost thousands of lives for human rights, liberty and democracy, all of which had been non-existent.

Herter Toasts Castro

He said he hopes that some day the people of the United States will recognize the whole truth of the revolutionary fight. And he said he wants to improve relations between this country and Cuba.

He declared there is no reason relations should not im-

prove because the Cubans have a good feeling for the people toasted the Prime Minister. The Acting Secretary said Cuba and the United States had co-operated in building and maintaining in the Western hemisphere an impregnable bulwark of independence, of order, of freedom within the law. He said the countries stand together, likewise, in defending the integrity of the free world.

Mr. Herter said an exact expression of the feeling here for Cuba was made by the Cuban hero, Jose Marti, which Marti spoke of the nations of this hemisphere as follows: "America must further everything that draws people closer together and abhor everything that separates them."

Castro Promises Cuba Will Honor Agreements

By Phil Casey
Staff Reporter

Fidel Castro said last night Cuba will live up to its agreements with the West and asserted he had never made any declaration of neutrality between communism and democracy.

The 32-year-old Cuban Prime Minister, speaking on the "Meet the Press" television program, on NBC (WRC-TV), thus clarified for the first time Cuba's stand in the East-West struggle. Cuba and the United States are members of the 21-nation Western Hemisphere Defense Alliance. Member nations pledge themselves to stand together if one member nation is attacked.

The bearded revolutionary denied that his brother, Raul, or Raul's wife, is a Communist and said that if there are any Communists in his government "their influence is nothing."

He promised free elections in Cuba "as soon as possible," and said that, in any event, they will come within four years at the latest.

He denied also supporting the overthrow of dictatorships in other Latin American countries. He pointed out that

Cuba's "doors are open to all political exiles."

He said that more than 1000 people accused of war crimes by his followers "have been exonerated without proof and the trials are finishing in Cuba." Later, Castro told reporters that he would not allow Cuba to be used as a staging area for the invasion of any other American countries.

Earlier, he told a group of Philadelphia Cubans that he would fight communism in his country by building hospitals and schools and improving the lot of the people, not by using force against Communists.

Immediately after the telecast at 4001 Nebraska ave. n.w., Castro drove to the Capitol, where he went into conference with Vice President Richard Nixon in the Vice President's office.

After two hours and 20 minutes behind closed doors, Nixon emerged with Castro from his office and said to the Cuban: "We will work with you."

The young Prime Minister's long, exciting and tiring day began at 9:30 a. m., after only a few hours sleep. He had been up until after 3 a. m. riding around the city and Arlington and visiting housing developments.

After his brief sleep, he went to Mount Vernon, showing interest in practically everything, particularly Washington's 1000-volume library.

At the Lincoln and Jefferson Memorials, where crowds of several hundred were gathered, Castro was besieged by autograph-seekers. He signed their bits of paper smilingly.

Castro, who laid wreaths at the historic shrines, read both the Gettysburg Address and the Declaration of Independence at the monuments.

As he read the Declaration, Castro murmured: "It is a right of the people to uprising. These words support the ideals of the Cuban revolution."

THE WASH. POST & TIMES HERALD
Page A.1 Date 4/20/59

SEARCHED	INDEXED
SERIALIZED	FILED
APR 20 1959	

b3
b6
b7C
b7E

Evelyn Peyton Gordon

Countless Newcomers Attended Castro Fete

CUBA'S FIDEL CASTRO made his debut in Washington society Saturday afternoon at a reception given by Ambassador and Senora de Dihigo. And for the occasion, the newly-named Prime Minister donned collar and necktie!

In fact, one of the Cubans who has been in-and-out of the embassy thru regime after regime, but who has finally lit on Fidel, said much time had been spent prettying up the revolutionary leader—smart uniform, white, collared shirt, dark tie, hair trimmed, beard shaped.

There were an endless number of people at the reception, but in my nearly 30 years of knowing the Cuban Embassy in Washington—from pre-Machado thru Batista into Castro eras—never were there so many guests I did NOT know, so FEW I did recognize!

Few members of Congress were present, perhaps because they had previously met with the youthful Prime Minister.

There were even fewer Ambassadors on hand. Soviet envoy, Menshikov was noted in conversation with Castro, Peru's Berckemeyer put in a brief appearance, Italian Ambassador and Signora Brosio strolled from next door to greet with visitor, and Ecuador's Jose Chiriboga made his duties.

One-time Cuban Ambassador Luis Machado, now Cuban representative to the World Bank, was much in evidence, chatting with Export-Import Bank president Sam Waugh. Popular Luis Machado has never been a follower of Fulgencio Batista.

His tenure as envoy here was during a period when the dictator was not holding of Presidential office.

Really in the limelight was Senora de Rivero, wife of a one-time Embassy attache, who has been in-and-out of office for a score of years. Rachel de Rivero appeared to be the hostess of the reception, since Senora de Dihigo was not around.



—UPI Photo.
Prime Minister Castro, in his white shirt and black tie.

WASHINGTON DAILY NEWS
Page 26 Date 4/20/59

SEARCHED	INDEXED
SERIALIZED	FILED
APR 20 1959	

b3
b6
b7C
b7E

WASHINGTON DAILY NEWS, MONDAY, APRIL 20, 1959 23



As a Visiting Fireman, Castro Has Been Fun

By ANDREW TULLY
Scripps-Howard Staff Writer

GIVE OR TAKE an occasional Tallulah Bankhead, a 32-year-old Cuban named Fidel Castro has made his mark as the most unconventional VIP ever to visit here in Washington.

Castro, who goes to New Jersey tonight, has broken almost every rule in the book since he arrived here last Wednesday night. He is Prime Minister of an important country, but here in Washington he has behaved more like a tourist from Dubuque.

Between times, in more or less formal meetings with government officials and before the American Society of Newspaper Editors, he has made some friends for his regime. These new friends have not gone overboard for the bearded revolutionist, but they are now taking a new look at him.

Castro has spread this good will mostly by the appearance of candor he has lent to both his official and informal utterances. He has presented himself as a man eager to be on friendly terms with Americans and anxious to explain the philosophy of his 26th of July Movement which now runs Cuba.

But it is to the average American that Fidel Castro has been most appealing. He has achieved this simply by acting like one of the folks. He has done so by forgetting protocol and the stiff-shirt conception of the foreign dignitary so he could get out and mingle with ordinary citizens.

It was fun for the patrons in the Peking Restaurant here suddenly to see Fidel Castro marching into the place with a little band of barbudos. And it was a fine public relations touch for other citizens, who weren't on hand, to read the next day that the stop was made simply because Castro suggested "let's get something to eat."

Prime Ministers ordinarily don't go marching across the street to chat with the people. Castro did that the night of his arrival when he went upstairs in the em-

bassy to go to bed and saw the crowd hemmed in by police lines.

Prime Ministers do not stroll in Meridian Hill Park and get their pictures taken holding babies, but Castro did. Prime Ministers generally avoid the press except for perhaps one formal meeting, but Fidel Castro held a press conference every time he could dig up more than one reporter.

History must wait to pass judgment on Fidel Castro. He could wind up a dictator or a communist, or both, despite his wholehearted protestations. But as a visiting fireman he has been a lot of fun.

SEARCHED [] INDEXED []
SERIALIZED [] FILED []

APR 20 1959

b3
b6
b7C
b7E

2 THE WASHINGTON DAILY NEWS, MONDAY, APRIL 20, 1959

SEES BETTER UNDERSTANDING BY U. S.

Castro Thinks Trip's Paying Off



—UPI Photo.

While touring Mt. Vernon, Fidel Castro was shown a "Castro doll" by Janet Dudman, 9, daughter of a Washington correspondent, who bought the doll in Cuba.

(See story by Andrew Tully on Page 23 and Evelyn Peyton-Gordon's column on Page 26.)

lish: "It is good not only for Cuba, it is good too for the U. S.?"

Cuban Prime Minister Fidel Castro appeared satisfied today that his five-day Washington visit had fostered better understanding of his new government.

His appeal to American public opinion continued with an address this afternoon at the National Press Club. He was to leave later by plane for Princeton, N. J., on the second leg of his U. S. visit.

Dr. Castro indicated he felt his American trip was off to a good start when he told a nation-wide television audience last night that his visit had brought "spiritual profits."

"I believe that here in the U. S. the people and everybody and the government are going to understand us better," he said in halting Eng-

MEETS NIXON

Later Dr. Castro spent two hours and 22 minutes chatting privately with Vice President Richard M. Nixon at Mr. Nixon's Capitol Hill office.

The session with Nixon capped a busy day for Dr. Castro, who in addition to his half-hour TV appearance visited George Washington's home and the memorials to Abraham Lincoln and Thomas Jefferson.

In a drizzling rain he placed a wreath on the tomb of America's first President. The wreath was inscribed: "The People of Cuba to George Washington."

Under sharp questioning from a panel of newsmen on the TV program (NBC-Meet the Press), Dr. Castro attempted to dispel apprehensions raised by some American observers that his new re-

QUIZZED ON REDS

Regarding reports his government is infiltrated by communists, he said "Their influence is nothing."

Dr. Castro denied he even said Cuba would be neutral in any struggle between the United States and Russia. He said he had stated only that Cuba was not prepared for war. This statement he added, was not an expression of neutrality.

In that connection, he said Cuba intended to keep its "international compromises" (meaning commitments) under the Rio Pact, which pledges American nations to come to the aid of one another in the event of an attack against any one of them.

Dr. Castro also denied that he or his brother, Raul, was a communist and said, "I am not agree with communism."

b3
b6
b7C
b7E

SEARCHED INDEXED
SERIALIZED FILED
APR 20 1959

These Days Fidel Castro

By George E. Sokolsky

WHEN Fidel Castro first appeared on the scene, he was greeted with great enthusiasm in the United States, where dictators are disliked and prospective dictators are regarded as liberals. Those who know little about Cuba, like myself, were impertuned to accept this man as an heroic figure, the savior of his people. Then I saw him on television addressing an hysterical mob and speaking with the irresponsibility which is so often recognizable in the front figures of a revolutionary movement. As I read what Fidel Castro was doing and saying I concluded that he is a characteristic front.



Sokolsky

Then came the massacres. I had lived through similar massacres in Russia and China. For some reason, they all seem to be alike. Someone gains power and goes out to murder people en masse. It appears to be an essential blood-letting in the early days of a revolution. But Fidel Castro looks like a softie and acts, on television, like an immature boy. True, I was asked to

come to Cuba to witness the blood-letting. I declined. I had seen similar exhibitions of man's gross inhumanity. It is not advantageous to have another look.

Then came the threats to the United States, and, of course, that was convincing that the man was a fool. A division of Marines could occupy the whole of Cuba and throw Fidel Castro and the bearded ones into the Caribbean. A sensible man does not make idiotic statements even to win applause.

Finally, Fidel Castro decided to come to the United States without protocol, which only goes to show that he is not too smart, because the advantage of protocol is that nobody is outwardly hurt. If Castro had waited until our Government had asked him to come, he would have been invited to stay at Blair House, as the guest of the Nation; he would have met the President; he would have had a ticker-tape parade in New York and a luncheon in the Waldorf-Astoria—in a word, all the trimmings that go to distinguished guests.

NOW, I have begun to receive letters from persons in Cuba or who have escaped from Castro, some of whom

had been his supporters, telling me what a horrible man he is. This correspondence particularly comes from well-known anti-Communist individuals and organizations. The correspondence is all of one kind, namely, that the Castro government is violently against anti-Communists, and that Castro is putting down the anti-Communists with as heavy a hand as he is putting down the followers of Batista. Whoever is active against anti-Communists must have Communist affiliations.

This has also been seen in every country where the Communists established what they call a People's Republic. Usually, in the very early stages of such a government, the objective enemy has been the anti-Communist. The Castro government followed the general pattern by legalizing the Communist Party. The difference between such a government as Czechoslovakia in the days of Jan Masaryk and the Egypt of Nasser is that in Czechoslovakia the Communists were legalized and eventually, they killed Masaryk and took power, whereas in Egypt the Communists are outlawed and persecuted.

(Copyright 1957, King Features Syndicate, Inc.)

A13

SEARCHED _____ INDEXED _____
SERIALIZED _____ FILED _____
APR 20 1957

b3
b6
b7C
b7E

Washington Scene By George Dixon

'El Picho' Castro Really Is After Tourist Trade

PEOPLE who get close-up looks at Fidel Castro seem to see the Cuban Prime Minister in many contradictory ways. Some see him as a liberator; others as merely a substitute dictator. Some see him as a foe of communism; others as a footsie player with the Reds.



Dixon

Some see him as a dedicated patriot; others as a mountebank. I have just had the privilege of being with him three times in four successive days. I see him as a pitchman.

I have a private theory that the reason Dr. Castro appears as so many different things to so many different men is that he is an actor. He strikes me as being an artist—of the protean, or quick-change, school.

He reminds me of many carnies I used to know in the old days, when I traveled with an Indian show. When he is talking, I can shut my eyes and imagine I am listening to an old carnival pitchman. Dr. Castro's English is difficult, but many of the carnies of my day were no Christian Hereters for unde-

filed usage of the Queen's tongue.

WHEN THE conqueror of Dictator Batista is holding forth, it doesn't take much imagination for me to fancy myself on a midway listening to a persuasive spiel. The accent and twisted English do not break the spell. I know several spellers who faked an almost identical accent to ballyhoo Latin fandango side-shows. They thought it added an air of authenticity.

Dr. Castro may seem to be filibustering in broken English but I noted that he always rambled to the point. He kept returning to his main pitch: "You like a fine time?—You come to Cuba." "You like to swim and lie in the sun?—You come to Cuba."

As I listened to him at the meeting of the American Society of Newspaper Editors; at the Cuban Embassy; and again at the National Press Club, it occurred to me that a great nickname for him would be "El Picho."

This bearded chap who has been pictured as a tough hombre with guns sticking out like porcupine quills; this callous avenger in jungle-grimed fatigues; turned out as far as I was concerned to be the pitchman for the Cuban tourist bureau.

"El Picho" pictured his country as a paradise where the visitor has nothing but fun; where no tourist ever gets hurt, or even into trouble of any sort. Jolly place, Cuba—he repeated over and over. In sentences so complex they might have been written by a Presidential economic adviser.

As one observer, who recalls the involved English purveyors of the New Deal, so descriptively phrased it:

"Dr. Castro came in like a tiger and went out like Dr. Rex Tugwell."

I FOUND his "Come to Cuba," a refreshing relief from the "Yanqui Go Home" of too many other Latin-Americans. He reminded me of an old-time pitchman because he kept saying, in effect: "You say you want more for your money—All right, here's another thing that Cuba has to offer!"

The 32-year-old Prime Minister said, over and over: "You can have a good time, and also help us."

I could picture myself lounging on a palm-fringed beach, surrounded by dark-eyed Latin lovelies plying me with dippers of rum—languidly restoring Cuba to economic solvency.

(Copyright 1959, King Syndicate, Inc.)

SEARCHED	INDEXED
SERIALIZED	FILED
[Redacted]	

b3
b6
b7C
b7E

Castro Says Cuba Will 'Legally' Expropriate Land

By Phil Casey
Staff Reporter

Fidel Castro, saying Cuba wants to be an example of "real democracy," told the National Press Club yesterday he will "expropriate legally" the land needed for agrarian reform.

This land reform, the 32-year-old Cuban Prime Minister said, is the "base" of Cuba's economic program to improve living standards and help destitute and "starving" Cubans.

The statements came in answer to a question about American-owned sugar plantations. Castro did not make clear whether the expropriations would be confined to land now idle.

"We are going to expropriate legally lands for agrarian reform," he answered, "not

nationalize them, not confiscate them."

Reasserting his belief in democracy and opposition to communism, Castro told the audience he wants Cuba to "be an example for Latin America of representative, honest government, and real democracy."

Predicting Cuba and the United States "will be wonderful friends," Castro said, in answer to a question about his feelings toward Soviet Premier Nikita Khrushchev: "We are against all kinds of dictatorship . . . that is why we do not agree with communism." He said he had not been offered or received any aid from Russia or any other country.

"Many men come here selling their souls," Castro said. "I really came here only seek-

ing for understanding . . . honest sympathies."

The young revolutionary disclaimed any interest in the military. "The last thing that I am is military," he said, adding that he wore his uniforms because they are "simple," and stand for the heroism of the Cuban revolution. "Cuba is the only country in the world without generals," he said. "The only one without colonels."

From Washington, the Cuban went to Princeton University where he spoke before what was perhaps the most unusual seminar in the University's 213 years. Washington Post Reporter Karl Meyer reported that Castro brought some 300 students and faculty

members to their feet, cheering, as he spoke on "Revolution" before a meeting of the American civilization study program.

Before he entered Woodrow Wilson Hall, about 1500 undergraduates nearly started a riot of the kind traditional at springtime on college campuses. State police managed to restrain the friendly students from mobbing the rebel leader.

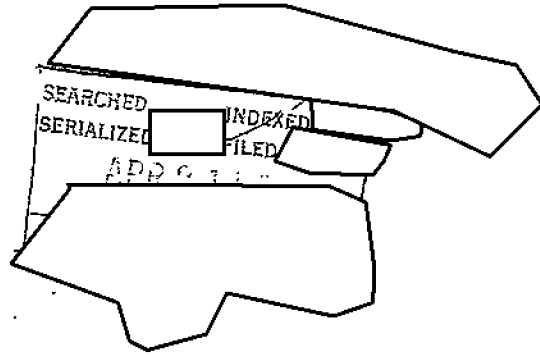

SEARCHED INDEXED
SERIALIZED FILED
APR 21 1959

b3
b6
b7C
b7E

New York Goes Wild Over Fidel

NEW YORK, April 22 (UPI) — Fidel Castro, the woolliest and most wildly welcomed statesman to visit New York in years, steps over the border into United Nations territory today. Security-harassed city police were grateful for the breather.

Cuba's Prime Minister was to meet with UN Secretary General Dag Hammarskjöld and to lunch with the United Nations Correspondents Association — unless he takes it into his head to do something else first.

pect a hero-hater in every hero-loving crowd, frantically tried to keep up with their happy visitor and keep him on the ground where he'd at least be harder to hit.

"I want to see the people," Dr. Castro kept saying. And see them he did — from 11 a. m., when he tried to join a crowd of 5000 cheering friends in Pennsylvania Station, until midnight, when he submitted to the good night embraces of 10 young women in bright red sweaters outside the door of his hotel room.

They pulled him off a stack of Pennsylvania station lockers, but they couldn't keep him from a brief ride on some people's shoulders.

The only known dissidents were half a dozen clean-shaven supporters of the deposed Cuban dictator Fulgencio Batista, armed only with placards, which police promptly tore up.

Dr. Castro was in and out of it all day and into the night. He charged up to police barricades to shake hands with viva-shouting, flag-waving admirers. The last 100 or so of them were pushed bodily into elevators by police at midnight when it appeared the bearded rebel hero otherwise would be holding court all night in a 17th floor hotel corridor.

Chief of Detectives James B. Leggett wasn't frusting anyone — "anybody can go down and buy a beard," he said.

"The people are wonderful!" Dr. Castro said. This is just the way it is in Cuba."

Police, who seem to sus-



—UPI Telephoto.
New York cop pushes Fidel Castro off lockers in Penn Station. Cuban leader wanted crowd to get better look at him.

SEARCHED... INDEXED
SERIALIZED... FILE
APR 22 1959

b3
b6
b7C
b7E

20,000 Hail Castro at ^{AM} N. Y. Station

NEW YORK, April 21 (UPI)—Cuban Prime Minister Fidel Castro was welcomed to New York today by a wildly cheering crowd of 20,000 and a tight security screen of police, who seized Castro's chief bodyguard for fear he might be a gunman.

The bearded man in uniform, who was picked up by police in the crowd awaiting Castro at the Pennsylvania Station, turned out to be Capt. Pedro Garcia, 31, the Cuban leader's chief bodyguard during his good-will visit to the United States. Garcia was released after he was identified and his revolver was confiscated.

The nearly 200 policemen had their hands full not only with the flag-waving crowd but with Castro, who appeared determined to shake hands with each of his supporters.

Instead of walking to a waiting limousine, Castro strode around it and into the crowd, many of them from the city's Spanish-speaking section. A group of admirers hoisted Castro onto their shoulders, and he was engulfed by the crowd.

Obviously overjoyed by the reception, Castro tried to climb onto a broad concrete railing in the huge terminal at one point so that the crowd could get a better look at him, but police managed to restrain him.

SEARCHED INDEXED
SERIALIZED FILED
APR 22 1959

b3
b6
b7C
b7E

Pledges All Aid 'Short of War' to Oust Dominican Republic Dictator

Castro Takes Aim at Trujillo



UPI Photo

Cuban Prime Minister Fidel Castro gives with a big smile and wave as he boards a train at Union Station for Princeton, N. J., for a speaking engagement. Behind him at right is Miss Teresa Casuso, a top assistant.

PRINCETON, N. J., April 21. (UPI)—Cuba's Prime Minister Fidel Castro said last night that his government will give all aid short of war to forces seeking to "liberate the Dominican Republic" from the leadership of Rafael Trujillo.

Dr. Castro spoke before a Princeton University graduate seminar after an uproarious, friendly greeting from more than 1000 other students and a few Cuban neighbors.

He was to make a morning visit to Lawrenceville School here and then head for New York for a four-day round of speeches and meetings with the city's large Cuban colony.

Dr. Castro told about 250 students and faculty members at Princeton's Woodrow Wilson School of International and Public Affairs that the Trujillo dictatorship in the Dominican Republic is a danger to his nation, and other American countries, because the island nation could be used as a springboard for anti-revolutionary forces.

LAND REFORM

In an address to the National Press Club in Washington yesterday, Dr. Castro:

• Said his government is

"going to expropriate legally" such lands as are needed in the agrarian reform movement to aid needy Cubans, but emphasized there would be no nationalization or confiscation of the land.

• Said "we are against all in kinds of dictators" when asked what he thought of Nikita Khrushchev.

• Made a fervent plea for the "best political and economic relations possible" with the U. S.

• Said (with a smile) "we'll shave our beards when we finish our job," when asked if Gillette still is sponsoring sports broadcasts in Cuba.

In other statements in Washington, Dr. Castro:

• Said he had not authorized any of his followers to support actively the Independent Movement, a minority party, in Puerto Rico and added that only the Puerto Ricans themselves can decide the political future of their island.

• Urged that the U. S. undertake a massive economic aid program to stamp out poverty in Latin America and said he shared Brazilian President Juscelino Kubitchek's view that such an effective economic development program requires "a Marshall Plan for Latin America."

(UPI)

SEARCHED INDEXED
SERIALIZED FILED

b3
b6
b7C
b7E

Washington Scene . . . By George Dixon

Cuban Embassy Looks Lived In—By Buffalo

THE CUBAN Embassy, which once had the appearance of an austere beautiful museum, now looks lived in. It looks as if it had been lived in by a herd of buffalo.

Too many hoarders ran rampant through it during the visit of Dr. Fidel Castro.



Dixon

The Cuban Prime Minister was on display twice in the once-impeccable edifice on Meridian Hill. This proved to be twice more than the chaste decor could stand.

The first exhibition of the bearded young celebrity drew 1500 Cuban nationals, all critics (old or recent) of deposed Dictator Fulgencio Batista. They burst into the mansion as if it was a free lunch counter, which, in effect, it was.

The Cubans became so excited at beholding their hero in the fur-covered flesh that they sprayed food all over the place, including the walls, and dropped what seemed to be thousands of burning cigarettes on the priceless rugs.

THE GREAT dining room, used to be one of the show places of the Nation's Capital, heavily featured on all garden and embassy tours. Punctilious guests were

went to gather about the tremendous refectory table, elegantly selecting an olive here, a stalk of stuffed celery there. The 1500 Castro followers fell upon it like a plague of chinaware-demolishing locusts.

The 32-year-old Prime Minister joined them in the browsing and sluicing, heartily brushing viands out of his beard.

The night following, Dr. Castro was put on display for an American audience. Again the Embassy was packed with excited drinking, eating, smoking humans.

All the Supreme Court was invited, and all the President's Cabinet. Nearly every one of the 98 Senators, and many of the 435 Representatives, were sent invitations. The response was unbelievable. I worked back and forth through the mob for more than two hours and didn't recognize a single one.

IT WAS the first Embassy reception I've ever covered in all my years in Washington that wasn't loaded, and free-loaded, with members of Congress. Even the most inveterate congressional partygoers, who would turn out for a party in honor of bathtub fixtures—and have stayed away.

I have since been informed, by a shouting disciple of Dr. Castro, that one representative from a Southwest State came in and stayed long enough to shake hands with

the Prime Minister. But I dare not print his name because he swears up and down it was a case of mistaken identity and threatens to sue me for libel if I say he was there.

I happened to be standing back of the receiving line, expecting any hour to see a familiar face, when a short, ugly report rang out. Several women blanched, but Castro stood firm in the line. I was debating whether to hide behind one of the ladies, or look for more substantial cover, when Madame Paul Koht, wife of the Norwegian Ambassador, called reassuringly:

"It wasn't a shot. It was a champagne bottle."

Still shaking, I followed my way along the beautiful red carpet, which was getting a pyrotechnic workout from lighted cigarette butts, this time of domestic brands. I don't think I could bear to look at that carpet again. It must look as if it had gone through smallpox.

One female guest gazed ecstatically at Dr. Castro, as she ground out a blazing butt with spikelike heel, and cried:

"He has such kind eyes!"

I hadn't recovered from this, when a fierce, guerrilla-warrior type, in open-front fatigue shirt, beard, and a pony tail, came striding toward me, his eyes burning with question. He turned out to be a Cuban reporter.

Copyright, 1959, by George Dixon. All rights reserved.

The Washington Post and Times Herald 4-22-59 PA 15

SEARCHED	INDEXED
SERIALIZED	FILED
APR 22 1959	

b3
b6
b7C
b7E

Cuba Holds American in Invasion Plot

HAVANA, April 21 (AP) — Cuban officials today identified an American as one of 31 persons detained for allegedly organizing a revolutionary expedition to Nicaragua on Cuban soil. He is Lawrence E. Hall, of Wichita, Kan., a former U. S. soldier and a veteran of Premier Fidel Castro's forces, the officials said. Officials said Hall, 29, was training a group enlisted by Nicaraguan exiles. The trainees were dressed in black and were called "The Shadows." Raul Castro, commander of Cuba's revolutionary army and brother of Premier Castro, said last night he would not allow Cuba to be used as a springboard for invasion of any country.

*The Washington Post and
Times Herald: 4-22-59.
p A9.*

[REDACTED]			
SEARCHED	INDEXED	[REDACTED]	[REDACTED]
SERIALIZED	FILED	[REDACTED]	[REDACTED]
APR 23 1959			
FBI WASHINGTON			
[REDACTED]			

b3
b6
b7C
b7E

Castro Leaves Doubts Despite His Sincerity

By JOHN V. HORNER
Star Staff Writer

High Government officials are concerned over Fidel Castro's casual attitude toward communism in Cuba and his lack of knowledge in economics and other important areas.

Those who talked with the young Prime Minister during his recent unofficial visit were pleased with his personal charm and his sincerity, but they appear disturbed by his beliefs and political inexperience.

Mr. Castro, whose actions as an officeholder have been unpredictable, proved to be unusually sensitive for a man in public life.

Shows Leadership

But in the appraisal following his trip to Washington, he is credited with having demonstrated the indefinable qualities of a leader of men.

In addition to his address to the American Society of Newspaper Editors and a brisk question-and-answer session afterward, Mr. Castro spoke to and answered the questions of members of the National Press Club, and he was interviewed by a panel on the NBC-TV program "Meet the Press."

Privately, he conferred with Vice President Nixon, Secretary of State Herter and other high-ranking officials.

After the television program Sunday night, he appeared nervous and tense. He told reporters he felt he had not made out as good a case for some of his views as he intended.

Public Opinion Theme

To some observers, Mr. Castro appeared almost obsessed with the idea that it is his responsibility to carry out what he construes to be the will of the Cuban people at a given time. He spoke constantly of public opinion.

Officials reportedly sought to convince him that a leader has responsibility not only of following public opinion but also of helping direct it in the proper channels.

The Prime Minister used the public opinion argument to defend his decision of delaying the elections. In the television discussion, he disclosed elections may not be held for four years because the people don't want them now.

United States officials tried to convince him that properly conducted elections should be held at the earliest possible date in order to restore the faith of the people in democratic processes. Otherwise, another dictatorship would be imposed.

Castro's reasoning was developed with regard to freedom of the press, the right to fair trials before impartial courts, judges and juries, and on other issues. Mr. Castro justified each of his departures from democratic principles by saying he was following the will of the people.

It was pointed out to the

young Prime Minister in various ways that while majority rule is right, even a majority can be tyrannous and there are individual rights which a majority should never have the power to destroy.

Mr. Castro was encouraged to take into his government as many strong men as possible and to delegate responsibility to them in the economic and other areas where he now makes decisions. One objective reportedly was to get the visitor to think in terms of how his place in history would be affected by the courage and statesmanship he displays at this critical time.

Concerned Over Economy

The Prime Minister showed obvious concern over Cuba's economic plight. He contended that a man who works in the sugarcane fields for three months and starves the rest of the year wants a job, food, shelter and clothing and doesn't care a bit whether he had freedom along with it.

An effort was made to convince him that, as a leader, he should try to develop support for policies which could assure economic progress with freedom, rather than without it.

Mr. Castro was said to have held it foolish for the United States to send arms to Cuba or other Caribbean countries because everyone should know these countries would not be able to play a part in the defense of the Western Hemisphere if a world war breaks out.

The arms received by governments in this hemisphere, he said, are used only to suppress people. Mr. Castro contended it would be far better if the money sent to Latin America for arms be provided instead for capital investment.

Prefers Government Capital

Reportedly, he favored United States Government capital rather than private investment in Cuba. It was explained to him that his best hope was to attract private money and that he would be serving the interests of Cuba better by adopting policies to attract it.

Mr. Castro made no effort to conceal his bitterness over the reporting of the revolution by the United States press. It was clear that he has not learned how to take criticism.

He was critical of this country's fear of what the Communists may do in Cuba and elsewhere. He said Americans should talk more of their strength and the reasons that the democratic system is superior to communism and other dictatorships.

Communism Explained

In an effort to put the United States attitude toward communism in context, American officials pointed out that communism is more than just an idea, that its agents are dangerously effective in grasping power and setting up dictatorships.

Mr. Castro also was told that the people of this country believe that being against communism is not enough—that it is even more important that what is done and said abroad convinces other people that the aim is to help them achieve economic progress in a climate of freedom.

THE EVENING STAR
Page A17 Date 4/23/59

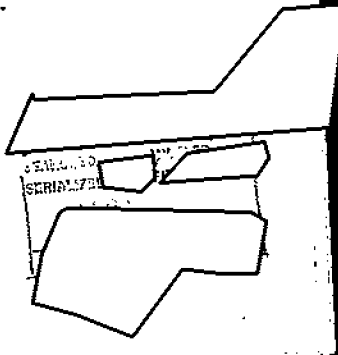

b3
b6
b7C
b7E

RALPH MCGILL

Castro: New Kind of Revolutionist

Cuban is Called Impressive in Speech On Sugar Statistics Instead of War

At last the very earnest, groping man was finished with his tortured labor of speaking in broken English to the American editors in convention assembled. The applause rose high and died. Security forces cleared the way, and he and his devoted entourage departed from the great ballroom of the Statler Hotel where so many famous persons have appeared.

Fidel Castro, Prime Minister of Cuba at the age of 32, had made his testament of faith in liberty in his country and ours.

The story already has been told. But no mere news story could capture the mood of it. Castro was bearded, yet he looked like a boy. He is a big man, yet he seemed almost like a high-school sophomore, awkward in elocution. He spoke the most broken English, but he was right and courageous to do that, even though many of those before him understood but little of what he said.

He did not excite them. He did not try to do so. They came to hear a revolutionist tell of how he had lived with death every day for a long span of years. But he talked to them of a small island country liberated from Spain by the United States in 1898, which since that time has had economic troubles and unemployment.

They came to hear him tell

of great daring and of dangers met and overcome. Instead, he talked to them of inequities of the sugar quota and of tariff. They came to hear fervor and to see glamor. He gave them statistics to show that at the depths of the great depression this country had but 14 per cent of its labor force unemployed, while for 30 years Cuba has had 24 per cent.

He stopped often, as the news stories have said, to obtain the proper English word from his old teacher who sat behind him.

If you ask me how was Fidel Castro as a show or an entertainment, I will tell you the truth. He was dull. But if you ask me whether or not he was impressive, I will tell you that he was. He is a new sort of revolutionist. He fits into the intellectualism of the 20th century. He is a teacher and intellectual and an idealist. Listening to him, and looking at him, there under the blaze of lights, one could imagine him lecturing his bearded rebels in just such a fashion in the mountains of Oriente Province.

His entourage looked on with the eyes of worship. They were a curious, almost bizarre group. Some were in leather jackets and khaki.

Some wore the best tailored suits available. Some of the ladies along were in the most stylish of suits and dresses. Others were in severe, plain skirts and jackets.

But I looked at the editors. Somehow, most of them seemed middle-aged, or old, and a great many flabby and gray. Not one of them had ever lived in a mountain retreat hunted like an animal. It was difficult for them, I am afraid, to comprehend the earnest, bearded young man who was so deeply concerned about a quota on sugar and who knew that the tariff on American trade was greater than the total income of Cuba. Some of the editors dozed in their chairs. Some read newspapers. There was not too much evidence of communication between them.

It was my good luck to see the Machado Revolution in 1933 and the coming of Fulgencio Batista, now in exile. Batista, too, was an idealist. He promised much. Power corrupted him. He became one of the most brutal dictators the world has known. I heard him speak in 1933. He was the romantic figure, the skillful rabble-rouser.

What lies ahead for this man, Fidel Castro, student, philosopher, and economist, whose adult years have been spent in revolution, none may say. But many hearts went out to him and many consciences wished him well.



SEARCHED... INDEXED...
SERIALIZED... FILED...

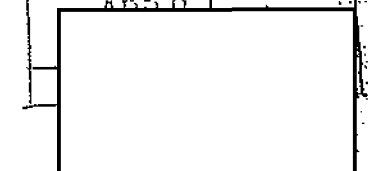

b3
b6
b7C
b7E

Fidel's Young Good Will Group Jeered in Contrast

Big Red Carpet for Castro in U. S. Puzzles Latins

By Edward TOMLINSON
LIMA, Peru, April 24

Many of the most prominent democratic leaders in South America are puzzled over the all-out red carpet treatment given Prime Minister Fidel Castro in the United States last week. The reason:

"Doctor" Castro has sent a group of his bewhiskered youngsters around South America on a good-will tour, but only the communists and other extremist factions have shown them any considerable attention.

NO RESPONSE

Here in Lima a few of the Apristas, members of a powerful left-wing but anti-communist movement, tried to arrange meetings and receptions for them, but got very little response from their own people. Then the young barbudos were jeered by the diners when they entered one of the leading restaurants.

Some of the most responsible citizens in Lima have pointed out that on the very day "Doctor" Castro was telling the newspaper editors in Washington that he and his henchmen were not communists, he was being extolled by Red leaders in several of the Latin American republics.

Manuel Mora, founder and head of the communist movement in Costa Rica, eulogized him as "a distinguished, cultured and true revolutionary."

The Reds of Brazil denounced Sen. Smathers of Florida for questioning the sincerity and motives of "the great Cuban democrat."

When I asked what he thought of the delegation of Fidelistas who had recently visited Lima, a waiter in the Hotel Bolivar said, "I don't like murderers, be they barbudos or Batistianos." He

picked up a copy of El Comercio, a leading Lima daily, from a nearby table and pointed to a dispatch that said, "15 more Cuban War Criminals were executed at dawn today."

QUESTION

"One of my oldest friends in Chile asked me to explain what he called 'this strange North American public opinion.' He went on to say that 'one day you are playing footsy with the dictators. Next day you are hailing some wild revolutionist.'"

Whatever we may think about it, the hundreds of executions in Cuba since the revolution have not gone down with the general public in these Latin American nations. With very few exceptions, the people who have condoned them have been flaming nationalists or extreme leftists.

In open revolution, in defense of his rights, his family, or in moments of passionate anger, the average Latin will kill. But deliberate execution by any government group or individual is not only revolting to them, but he considers it plain murder.

LOST FRIENDS

Next to his insistence upon shooting former subordinates and policemen of Batista, U. S. thing that has lost Castro friends throughout Latin America has been his expressed intention to help overthrow other dictators and "undemocratic governments" in neighboring countries.

Nearly all Latins resent any outsider meddling in the political affairs of their countries.

They used to denounce Uncle Sam for what they considered his penchant for intervention, whether against a dictator or any other kind of a regime.

Most Mexicans never forgave Woodrow Wilson for

ordering the invasion of Mexico to oust President Victoriano De la Huerta, who was a dictator.

Argentines, even many who were opposed to Peron, resented former Ambassador Spruille Braden's open condemnation of the dictator.

It will take Fidel Castro a long time to live down his boasts about bringing democracy to his "oppressed neighbors."

WASHINGTON DAILY NEWS
Page 10 Date 4/24/59

SEARCHED	INDEXED
SERIALIZED	FILED
APR 24 1959	

b3
b6
b7C
b7E

Castro's U. S. Visit . . . By Roscoe Drummond
Some Impressions He Made

IT IS all to the good that Fidel Castro has paid an early visit to the United States. He is an engaging, almost mesmeric personality. He is a fact of life of importance to the United States as well as to Cuba. His country will feel his leadership and he may prove a powerful force throughout Latin America.



Drummond

Now that Premier Castro is returning to Havana after being in our midst for nearly two weeks, I should like to try to set down something of a net appraisal of the impressions he has made in Washington.

It is a mixed impression. It is personally friendly, politically hopeful, inescapably reserved. He came and saw and neither won nor lost the whole confidence of American officials.

From watching and listening to him in several public appearances and from talking with some who saw him privately, the judgment which I find widely shared is:

That Dr. Castro sincerely wants to serve the interests of the Cuban people, believes in democratic government for Cuba and wishes to bring it about.

That Dr. Castro thus far shows little understanding of the processes of democratic government and seems to think that by some mystical sense he can at any and all times feel what the Cuban people want and that some-

how this is the substance of democracy.

WE NEED to appreciate that for a long, harsh period Fidel Castro had to devote all his energy and thought to freeing Cuba from a tormenting dictatorship. A successful revolution is not run by a committee or by the ballot box. He has been leading a military crusade "for the people." His harder and more worthy task is to create a government "of the people and by the people."

We have no right to expect that Dr. Castro can replace Cuban dictatorship with Cuban democracy overnight. Our only concern—and our hope—is that he is headed in the right direction and that there be no unnecessary delay.

HERE IN Washington Dr. Castro devoted himself to offering reasons why popular elections should be put off—even for several years.

He argued that the Cuban people "do not want elections because the past elections produced bad governments."

Isn't this a reason for holding elections at an early date as the best possible way by which Dr. Castro can restore public faith in the democratic process? The heart of democratic government is not that it never produces bad government but that a "bad government" can be thrown out by ballot and does not have to be shot out by recurring revolution.

Dr. Castro seemed mystically certain that all his actions are justified by and will be guided by the popular will of the Cuban people. I would not offend Dr. Castro, but I cannot forget that every mod-

ern dictator—he does not wish to be one—is either sure he is acting in response to popular will or justifies his actions on that basis.

Any government of any kind is not representative government without elections. It is unrepresentative government. It may temporarily or accidentally reflect popular opinion, but there is no substitute for elections as the only certain, authentic voice of popular opinion. Elections shouldn't be called hurriedly but they should not be postponed too long—or for the wrong reasons.

THESE ARE some of the honest anxieties of many who got to know and to like Premier Castro while he was here. They are also concerned by his apparently naive attitude toward Communists in Cuba on the theory that they are just extreme but earnest idealists rather than deadly agents of a conspiracy of dictatorship.

The private talks with Dr. Castro were almost all invariably frank and outspoken—both ways. That in itself shows that he has been among friends who wish him well.

(Copyright, 1959, New York Herald Tribune, Inc.)

SEARCHED _____ INDEXED _____
SERIALIZED _____ FILED _____
APR 27 1959

b3
b6
b7C
b7E

Conference of the Castros



—UPI Telephoto.

Raul Castro, right, listens closely as his brother, Fidel, talks with reporters at Houston, Tex. Raul joined Dr. Castro's party there for a conference and denial of rumors that the brothers had split. Fidel was to receive a gift horse from a Texas rancher today, and hoped to take it on the plane with him when he takes off for Buenos Aires. Dr. Castro denied any Cuban participation in the Panama rebellion.

Cuba Acts to Halt Invaders

Rebels in Panama

PANAMA CITY, April 28 — Sizeable rebel reinforcements from Cuba were reported converging today on Panama where loyal forces strengthened by U. S. arms and ammunition were fighting to encircle invaders who seized a coastal village.

A government communique said "several" invaders were killed or wounded in a clash with patrol boats lying off invader-held Nombre de Dios, 75 miles from the Panama Canal, in the first known fighting in the four-day-old invasion.

The invaders also fired on a government reconnaissance plane over the Caribbean village, the government said.

PATROL

An official announcement said the National Guard, Panama's only armed force, is patrolling the waters off Nombre de Dios to block escape by sea while ground troops "maintain complete vigilance on land."

Interior Minister Jose D. Bazan said reinforcements are on the way to the "front."

Sr. Bazan said the invaders appeared to be sticking to the north coast, perhaps hoping to link up with about 300 reinforcements said to be on the way from Cuba before they try to advance southward toward Panama City.

Prisoners taken during the early hours of the invasion said two more ships carrying 300 men were to have sailed from Cuba at the same time as the *Mavari*, the invasion craft which landed during the weekend. The whereabouts of the other two ships are unknown.

SEIZURE

Cuban Charge d'Affaires Ricardo Riano Juama revealed yesterday for the first time that Cuban authorities halted a ship carrying 300 men to Panama two weeks ago, but it was uncertain that this was the ship mentioned by the prisoners.

Cuban authorities here and in Havana were co-operating

in efforts against the invaders, many of whom are Cubans.

Prime Minister Fidel Castro's revolutionary regime flew two high-ranking army officers here to arrange the surrender of the "expeditionary force" and take its Cuban members home.

Cuban authorities were said to have assured Panama that any Cubans captured among the invaders will be court martialed for desertion, whether they are soldiers or civilians.

Dr. Castro's brother Raul flew to Houston, yesterday for a conference with the Prime Minister, who has been touring the United States and Canada. Altho the purpose of the conference was not announced, it was believed to be linked with the Panama invasion.

Sr. Riano prepared the text for bundles of leaflets which were airdropped on Nombre de Dios, urging Cubans among the invaders to phone him and arrange a conference.

b3
b6
b7C
b7E

SEARCHED
INDEXED
FILED

WASHINGTON

Heavily Guarded Castro Promises U. S. Sugar Sales Will Aid Cubans

NEW YORK, April 24 (AP).—Fidel Castro, campaigning for increased United States imports of Cuban sugar, visited the New York Coffee and Sugar Exchange in the financial district today.

The bearded Cuban Prime Minister opened the day's trading by making an appearance on a speaker's platform at 10 a.m. while several hundred traders and bystanders clustered around him.

He said most Cuban sugar was sold through the exchange and pledged that income from the sugar would go toward things that would be useful for Cuba.

About 200 persons were waiting outside the Statler Hotel as the revolutionary leader left for the Exchange. He smiled and waved as he stepped into a limousine.

Escorted by Guards

Mr. Castro, wearing his familiar army fatigues, was escorted by a heavy guard of detectives, uniformed policemen and State Department security agents.

Charles S. Lowry, exchange president, gave him a gavel to open the session.

Mr. Castro spoke briefly. A member of his party, Dr. Rulo Lopez Fresquet, Minister of the Treasury, then told the traders, "We are interested in having a higher price for our sugar."

Police made a thorough search of the 12-story Exchange Building during the night after a watchman reported he had seen two men acting suspiciously in a second floor hallway at 11:25 p.m. He said he chased the men and that they left the building by way of a fire stairway.

Members of the police bomb and emergency squads found nothing in the search.

Plot Reported

Meanwhile, a widespread investigation apparently took the steam out of a reported plot to kill Mr. Castro.

Aides to the Prime Minister touched off great excitement yesterday when they notified police they had heard that two sets of hired gunmen were seeking to assassinate him.

One set allegedly consisted of five brothers from Philadelphia, and the other of two brothers from elsewhere.

It was learned that the former group all had been located at work in Philadelphia. One of the other pair was said to have been found in a Las Vegas hotel and heatedly denied he was involved in any plot.

The biggest security guard ever provided for a visitor to New York was assigned to Mr. Castro after the purported assassination plot was averted, and the entire police force was put on special alert.

There have been numerous threats against the Cuban chieftain.

Police said the supreme test of the security forces will come tonight when Mr. Castro addresses a rally on the mall in Central Park, where the wooded and rolling terrain will increase the difficulties of the guards.



WALL OF BLUE—Police, alerted to a reported plot by hired killers to assassinate Fidel Castro, threw a shield around the Cuban Prime Minister on his arrival at New York City Hall yesterday for a visit with the Mayor. The bearded Castro walks behind Chief Inspector Thomas A. Neilson, commander of New York's uniformed police force.—AP Wirephoto.

THE EVENING STAR
Page 13 Date 4/24/55

SEARCHED _____ INDEXED _____
SERIALIZED _____ FILED _____
APR 24 1955

b3
b6
b7C
b7E

Castro Hops Over Rail in Bronx Zoo, Beards Lion and Tiger in Their Dens

NEW YORK, April 24 (UPI)—Cuban Premier Fidel Castro, trailed by one of the largest security forces in the City's history, casually hopped over a guard rail at the Bronx Zoo today and got within hand-shaking distance of a lion and a tiger.

The incident that threw security men into a tizzy occurred on the final day of his New York visit, which began with a baseless bomb scare.

Castro, who yesterday brushed off a reported plan to assassinate him, complied reluctantly with a police order to get back over the rail.

"They don't do anything," he said, apparently meaning

that he believed the animals would not harm him.

Security men were faced with this unexpected danger

to the Cuban Premier only hours after they had searched a 12-story building housing the New York Coffee and Sugar Exchange for a bomb feared planted to assassinate Castro. No bomb was found.

The security force guarding Castro was augmented heavily Thursday after police were informed by Cuban officials that eight men were involved in a plot to assassinate him. Police located the men in other cities and established their innocence of any such plot.

Castro climaxed his hectic visit by appearing before a wildly cheering mass night rally in Central Park.

The Washington Post &
Times Herald, Sec-A.P-4
4/25/59.

SEARCHED [] INDEXED []
SERIALIZED [] FILED []
APR 25 1959

b3
b6
b7C
b7E

Castro, in Montreal, Appeals For Capital and Know-How

MONTREAL, April 27 (AP).—Prime Minister Fidel Castro appealed to Canadian businessmen last night to invest their money and know-how in his Caribbean republic.

Mr. Castro, who arrived in Montreal yesterday for an overnight visit after his United States goodwill tour, left by plane this morning. His itinerary called for a luncheon stop at Houston, Tex., before flying on to Buenos Aires for a visit.

Speaking to a group of businessmen invited by the Montreal Junior Chamber of Commerce, Mr. Castro declared:

"We are asking that Canadian money be invested in Cuba, that Canadian experience be invested in Cuba.

"We think your spirit of enterprise will be welcome in our country because now in Cuba we are beginning a new era."

Mr. Castro said that, although Cuba still has economic problems to overcome in the wake of ex-Dictator Fulgencio Batista's regime, his government has taken drastic measures to end them.

He cited farm and construction programs, a new honesty in government and increased tax collections.

The welcome and Mr. Castro's informality gave the Canadian security police the same headaches United States police had suffered.

On his arrival from Boston, Mr. Castro pushed police aside and waded into the crowds waiting for him at the airport and at his hotel. He shook hands with all who approached him.

Officials in Houston had planned to stage a barbecue in Mr. Castro's honor. When they received word that his visit would be cut short, they arranged for 150 of Houston's top citizens to shake hands with him at a luncheon.



SEEKS INVESTORS—Fidel Castro is welcomed in Montreal where he appealed to Canadian businessmen to invest money and ideas in Cuba.—AP Wirephoto.

SEARCHED INDEXED
SERIALIZED FILED
APR 28 1959

b3
b6
b7C
b7E

Castro Brothers Confer in Texas

HOUSTON, Tex., April 27. (AP)—Fidel Castro, Prime Minister of Cuba, landed here today en route from Montreal to Buenos Aires. He found his brother, Raul, present for an apparent emergency session.

Raul, commander of Cuba's armed forces, flew here unannounced in a chartered airliner. He gave no reason for his hasty trip, but unconfirmed reports in Cuba said a disagreement had arisen between the brothers.

Leading citizens of Houston had planned a barbecue for Fidel. When they received information the visit would be short, a luncheon was substituted.

The food grew cold, however, when Fidel delayed his departure from Montreal to shake hands and talk with Canadians.

Castro plans to attend a Latin American economic conference in Buenos Aires.

[Redacted]

SEARCHED.....INDEXED.....
SERIALIZED.....FILED.....

[Redacted]

b3
b6
b7
b7

Castro Leaves U. S., Bound for Argentina

HOUSTON, Tex., April 28 (UPI) — Cuban Premier Fidel Castro, who is reported deeply concerned about an invasion of Panama although he denies having anything to do with it, finally got off today to a Conference of American States at Buenos Aires.

His departure was almost 24 hours overdue, since he was supposed to have been in Buenos Aires today. He stayed here overnight to talk to his brother Raoul, who flew in from Havana.

Castro made a 65-mile trip from Houston to the Bar JF Ranch near Wharton, Tex., to see a gift colt. He never did succeed in seeing it. But J. B. Ferguson, who gave him the colt, promised to ship it to Havana as soon as it is big enough.

Castro's junket to the ranch was delayed an hour-and-a-half while security officers looked for his campaign camp. He lost it yesterday while trying on a cowboy hat for photographers. The Premier's hearded guards mounted some of the horses at the ranch but they didn't do it with the practiced assurance of Ferguson's cowboys. The Cuban Airlines jet-prop plane bearing Castro took off for Trinidad. He had not decided when he



The Washington Post

Invasion Zone

Map locates town of Nombre de Dios, where two Cuban officers have contacted an 80-man army that has invaded Panama. Story on Page A1.

left whether to spend the night in Trinidad or fly on to Buenos Aires after a refueling stop.

SEARCHED _____ INDEXED _____
SERIALIZE _____ FILED _____
APR 29 1954
[Redacted]

b3
b6
b7
b7

Cuban Labor Militia Is Set For Parade

HAVANA, April 29 (AP)—The first contingent of a Cuban workers' militia is expected to take part in Havana's May Day parade Friday.

The president of the Cuban Confederation of Labor, David Salvador, has been advocating formation of such a militia to help "safeguard the revolution" of Fidel Castro, now Cuban Premier.

Maj. Ernesto Guevara, who commands Havana's La Cabana military fortress, said on TV last night the idea of such a militia is "to defend the revolution, so that all enemies may know that any attack will encounter not only the army but an armed people which wishes to enjoy the fruits of liberty."

The Argentine-born Guevara has been called a leftist, but declares he is not a member of the Communist Party.

Guevara said in the TV broadcast that in his opinion the Communists are "capable of working honorably" with other groups in Cuba in support of the revolutionary program. He said he did not think Cuban Communists will attempt a putsch, but if they do he will be the first to fight it.

In statements to Cuban newsmen in Houston, Tex., this week Maj. Raul Castro, commander of Cuba's armed forces and brother of the Premier, denied he was a Communist.

Both Raul and Guevara have said outside influences are trying to put a Communist label on Cuba to disrupt the revolutionary program.

[REDACTED]	
SEARCHED [REDACTED]	INDEXED [REDACTED]
SERIALIZED [REDACTED]	FILED [REDACTED]
APR 30 1957	
[REDACTED]	

b3
b6
b7C
b7E

Castro and Communism

By Lyle C. Wilson



CUBAN Prime Minister Fidel Castro has moved on without quieting alarming reports that communists have bled into his revolutionary movement.

Castro's stock answer in the United States about communist infiltration was this:

"If so... their influence is nothing. I don't agree with communism. We are a democracy. We are against all kinds of dictators. That is why we oppose communism."

The facts are that Castro has been associated with communists for some years. U. S. communists have been bragging for months about the participation of Cuban Reds in Castro's revolution. Castro may oppose communism, as he says he opposes it. There is much evidence, however, that some sharp-shooting communists are among his associates. Some of them were in Castro's party which visited the United States.

All of this is a matter of record with names, dates and places. There is evidence that a Cuban who was prominent in the communist youth movement in 1950 presently is participating in the training of the Cuban Army.

Another, who accompanied Castro to the United States, is a Communist Party member and an official in the Confederation of Cuban Workers. This individual is an adviser to Castro on labor affairs.

One of Castro's traveling companions to the United States has been an officer of the communist youth organization called Juventud Revolucionaria Cuban. He was at one time president of the Lugano District Communist Party in Havana. Another traveling companion had been a communist leader in Oriente Province; still another was ejected in 1954 from the Federacion Provincial de Sociadades on charges that he was a Communist Party member.

There is no record of Communist Party membership either of Fidel Castro or his brother Raul. The Raul Castro record, however, indicates that he is bitterly anti-American. The whole set-up is disquieting to persons who realize the extent to which the Reds have infiltrated the Castro revolution.

If the Cuban communists became dominant in Cuba, the United States would be faced with grave considerations of national security. A communist Cuba would be a pistol at the head—a knife at the throat—of the United States.

The troubles which could flow from such a situation would be both difficult and dangerous. The United States scarcely could suffer a communist state to flourish on its doorstep.

[Redacted]

SEARCHED	INDEXED
SERIALIZED	FILED

[Redacted]

[Redacted]

b3
b6
b7C
b7E

Castro Diverted To Sao Paulo

SAO PAULO, Brazil, April 30 (AP).—Cuban Prime Minister Fidel Castro arrived by plane last night for a brief visit to Brazil.

The airliner bringing him from his trip to the United States and Canada landed in Sao Paulo after a damaged runway kept the craft from putting down in Rio de Janeiro.

Mr. Castro was scheduled to fly on in a smaller plane today to Rio to meet President Juscelino Kubitschek.

Mr. Castro was met here by high-ranking Brazilian officials and reviewed a unit of Brazilian troops at the airport.

He is to go from Brazil to Argentina for a meeting of the Committee of the 21, an organization made up of Latin American nations and the United States.

[REDACTED]	
SEARCHED	INDEXED
SERIALIZED	FILED
FBI - WASHINGTON	
[REDACTED]	[REDACTED]

b3
b6
b7C
b7E

Moral Support Promised Rebels

HAVANA, April 22 (AP).—The commander of Cuba's revolutionary army has promised Latin-American refugees fighting dictatorships moral support—but that's all.

Raul Castro, who took over command of the army when his brother Fidel became Premier has said he was against Cuba being a springboard for invasion of any country.

"Every country has to conquer its own freedom," the younger Castro said in a speech at Havana University.

Panamanian President Ernesto de la Guardia, Jr. has charged that Panamanian opponents of his regime are organizing an invasion in Cuba. Opponents of Haitian President Francois Duvalier have set up headquarters in Santiago de Cuba, and Cuba also is a haven for opponents of Dominican Dictator Rafael Trujillo.

[Redacted]

SEARCHED INDEXED
SERIALIZED FILED

[Redacted]

b3
b6
b7C
b7E

A15

Castro Greeted at U. N., Visits Hammaraskjold

Page A15 Date 4/22/55

NEW YORK, April 22 (AP)—Cuban Prime Minister Fidel Castro, in battle fatigues, arrived at the United Nations shortly after noon today for a visit with Secretary General Dag Hammarskjold.

There were shouts of "Fidel, Fidel" from a crowd of about 250 as the Cuban leader's motorcade drew up at the Secretariat Building.

Mr. Castro was met by Pierre de Meulemeester of Belgium, acting U. N. chief of protocol; Manuel Bisbee, Cuban Ambassador to the U. N., and Roberto Cuatrecasas, U. N. commissioner of public assistance.

They escorted him to Mr. Hammaraskjold's office on the 38th floor. Mr. Castro was expected to remain at the U. N. most of the day, and planned to speak to correspondents there.

An unusual security force was mustered to watch over the Cuban leader. It included 90 U. N. guards—40 more than the normal shift.

Visitors were carefully screened. "This is a restricted area now," a guard told a man who claimed Mr. Castro's friendship.

While Mr. Castro visited with Mr. Hammaraskjold several of his bearded followers roamed the lobby, stopping occasionally to talk with onlookers.

Meets Cuban Newsmen

Before going to the U. N. the Prime Minister met with Cuban newsmen and photographers at his hotel. His press secretary, Mrs. Ernestina Otero, barred American reporters, saying it was a "private conversation" which would produce no news.

It was learned that the Cubans wished to protest their treatment yesterday while attempting to follow the Castro party. The Cuban newsmen did not have New York working press cards and apparently were shunted aside at several points by security people.

Mr. Castro was given an enthusiastic welcome to New York yesterday. He is in this country in an unofficial capacity; he was invited by the American Society of Newspaper Editors.

At the halfway mark of a tour to "promote Cuba" among Americans and Canadians, Mr. Castro told reporters that the noisy welcome by some 20,000 New Yorkers—largely made up of the city's big Latin American colony—"pleased and impressed me."

14-Hour Schedule

It was almost midnight last night when he wound up the last official event in a 14-hour schedule that included three speeches, lots of handshaking and police-led scrimmages in and out of his hotel head-

quarters and other places he visited.

The reception by so many Latin Americans so impressed him. Mr. Castro told a University of Columbia School of Journalism conference, that it made him wonder why the Spanish-speaking Americans do not band together in a United States of South America.

But he has no aspiration to head such a union, he said.

Other Points

In his first full day in New York, the 39-year-old lawyer revolutionary also said:

1. His government might set a date next month for election but the actual date is another matter. Mr. Castro has previously said his government would not stay in office longer than four years, but that elections could be called at any time.

2. He may not seek the presidency when the elections are called.

Not so pleased with their New York reception were some 20 Cuban newspapermen accompanying the Prime Minister.

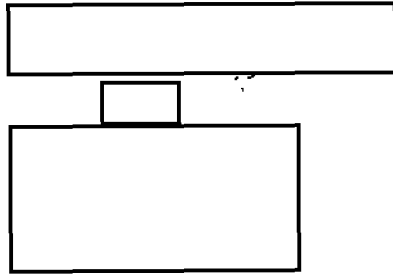

b3
b6
b7C
b7E

THE WASHINGTON DAILY NEWS
Condemned Informer



—UPI Telephoto.

Dr. Olga Herrera Marcos, a former school teacher shown at her trial in Havana, was convicted of informing for the Batista police and sentenced to death. She is the first woman condemned by the military tribunal of the Castro forces. Her former husband testified against her.

SEARCHED... []		INDEXED []	
SERIALIZED []		FILED []	
APR 30 1955			

b3
b6
b7C
b7E

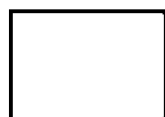

PREMIER'S MEN WIN CUBAN UNION ELECTIONS

Communist Call Castro 'Divisionist'

HAVANA, May 27 (UPI)—The Cuban Communist Party accused Prime Minister Fidel Castro today of endangering the success of the Cuban revolution by making "divisionist" moves against the communists.

The charge was made by Party Secretary General Blas Roca during an emergency meeting of the Communist National Committee, called to hear a leadership report that Dr. Castro's "strong anti-communist campaign" threatened the "unity of the forces supporting the revolution" just at a time when the revolution was "in a critical moment."

Widening the breach between Dr. Castro and the communists, Roca blamed Castro personally for unleashing the "rightists and plattists (pro-Americans) against the communists." The name "Plattists" stems from the Platt Amendment which for several years after Cuba won its independence from Spain with U. S. aid gave the U. S. the right to intervene in Cuban internal affairs.

Rightists and Plattists, Sr. Roca said, have seized on Dr. Castro's "imputation" that communists were guilty of counterrevolutionary acts to sow disunity.

Sr. Roca's broadside came on the heels of returns showing that Dr. Castro had consolidated his control of organized labor when his adherents were swept into office in elections held by key unions during the weekend.

Returns showed today that Castro followers had been elected by the vital Havana waterfront labor groups, including the manual workers and stevedores unions as well as by individual unions such

as the Ward Line, Norgulf and Havana Docks Corp.

Preliminary elections by the brewery workers' union also were won by the July 26 Movement; the artists' association voted in a slate pledged to the Castro regime; while elections in the smaller beverage workers' and Havana salesmen's unions all were favorable to the revolutionary government.

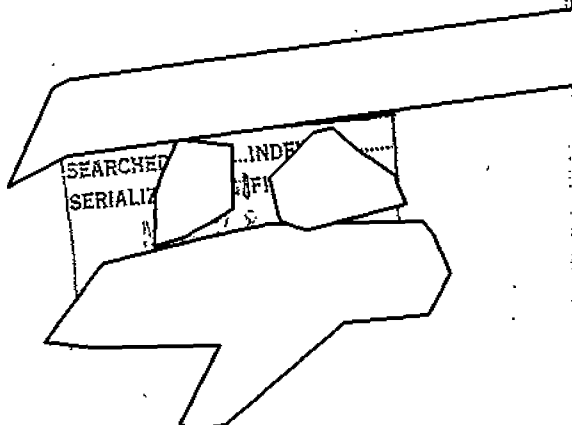

b3
b6
b7
b7

10,000-Mile Journey

CHANGES HAPPENING IMPENDING

GO.—In 1886, the
McCormick Work
nal Harvester Co. d
tools and struck fo
ur day. This was
hat helped spark
ital and successful st
the eight hour day
was one of its at
the Haymarket Sq
This was America's

today the McCorm
on the eve of apo
face a new giga
It is for the protec
jobs. Word has gone
plant that was built
to be dismantled and
others be thrown on
top.

Company contends that
"obsolete." To this
the United Auto Work

Day

ation of contracts
s. This year the
plumbers, painters
at a 35 hour work
hours pay.

building trades work

Thousands are out with petition
lists for the march on Wash
ington the 18th of this month.

But one domestic phenomenon
creaks along like the one-hoss
shay. Though it owns all the ad
vantage of supersonic techniques,
its meaning and content are way
behind the timer. I speak of our
nation's press. The newspapers
are dismal — by and large, with
few exceptions, and these, per
haps not too honorable.

Pick up a paper in Chicago and
it is a spitting image of the pa
per in Seattle; buy one in L. A.
and you can't remember if you
saw it or a dead ringer for it,
in San Francisco. Change the
style of type a bit, and you have
the same paper; the same col
umns, the same columnists, the
same editorials, the same near
derthal line of thought. Lord,
how far can a national pheno
menon, so big and so mighty, fall
behind.

The people at my meetings
realized that; that is why they
came. They were exhilarating; the
enthusiasm for Cuba; the desire



SAW
MAY DAY
VETERAN REPORT

In 1912 the unemployed
workers great free speech
these years were scenes
these for many years.
crowd for May Day
always has been the
Grand Circus Park in
peace and jobs
demonstrations against
for shorter days to m
May Day, from work
an inspiring number of
Since that day Detroit
ing the way.
Fourth Infantry Regim
with the Regimental Ba

The Worker
April 26, 1959
page 8 columns 2, 3, 4
page 9 column 1

SEARCHED	INDEXED
SERIALIZED	FILED
MAY 1 1959	

b3
b6
b7C
b7E

BIG THINGS HAPPENING — AND BIGGER IMPENDING

By JOSEPH NORTH

THE CONTINENT is just as big as it was when Lewis and Clark beat their way across the craggy passes and though you whizz through the air two miles up you are just as excited seeing the Rockies beneath you as you were the first time a score of years back. The fact that you can cross the Continental Divide faster hasn't shrunk the terrain any, nor diminished the problems of the inhabitants peopling the land.

Returning from some 10,000 miles of travel, mostly by air, telling audiences in some 20 cities what you saw in Cuba, leaves you a bit breathless when you make the trip in 21 days. There is a kaleidoscope of experience and sensations, but you talk to enough people after your meetings to know that 1959 is like no other year in which you've made the great American tour.

And May Day 1959 is a good time to say it.

THERE IS an air everywhere of big things happening — and bigger things impending. In Detroit and elsewhere, talk about employment and automation and what to do about it; in Los Angeles you hear the citizens refer, not only to the smog, but what shall we do about atomic fallout — and while you are there a conference of top-flight scientists heard unprecedented speeches about the wastefulness of our contemporary economy and lauded the missile-making madmen of Seattle's longshoremen told of the need to recognize Peking China and to cultivate the vast Asia market — both for jobs and in peace; in Cleveland, passing the remarkable tributes to the many peoples who have built the city — the statuary of various cultural heroes of many lands in the municipal park — you hear of Cyrus Eaton and his fight for co-existence in one world.

And people tell you of the revealing revelations of CBS that the movie stars in Rome where she works — Communists in it, and that our own industry had blacklisted its best-gifted practitioners. In many a city the parents are tackling the bastions of television and the toll it is taking in the smog of our children; everywhere parents and teachers are spurring, as they said, by the great advances in the Soviet Union.

EVERYWHERE, like a bas-relief map where you see the Appalachians over on the East, the Rockies on the West, the Great Lakes in the middle, two primary ideas loom like Alps — how to beat the menace of widespread unemployment, and how to ward off the thermonuclear horror from gobbling up the world.

I went to talk about Cuba, the new Cuba; and whenever I told Americans what I saw they replied, like the man in San Jose — "Those Cubans, make me feel twelve feet tall. They love me, how the 66 left Mexico on the leaky old scow that lonesome night in December of 1956 to head toward Oriente are enthralled as they learn that this man, Joseph North, is the man who saw the fall of the old regime in Cuba."

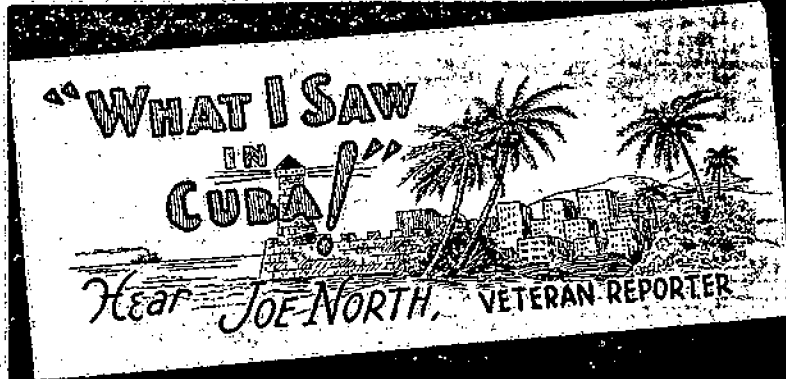

Drawing by Seattle artist for a leaflet advertising Joseph North's meeting in that city.

wild heights of the Sierra Maestras, discovered their people ready and willing. And how the people's army, the guerrillas, grew day by day, week by week, to be the mighty fighting arm of a nation united against "la tyrantía" — the tyranny of the Caribbean Hitler — Fulgencio Batista.

THE HEROES of old did not die in the pages of Homer; they walk the earth today these Americans feel as they learn the truth about the new Cuba. Victory anywhere in the world inspires men everywhere in the world — and especially when it is on this hemisphere.

You sense impatience with the old outworn speeds; it is the Space Age and Man wants to get where he wants to go faster than ever before. Many today know that socialism is travelling — not with seven league boots — but with the speed of the pioneering sputnik. Something real big — gigantic — is happening over there and they know it. It is a challenge that can inspire emulation. Nor is it lost to many that I met, on the Left certainly, and from elsewhere — that the socialist nations are the ones who take the lead on proposing ideas for peace. The Eaton idea is spreading — live on one world as neighbors or die on one world like pterodactyls.

THAT, but more. Home questions grow bigger — the issue of segregation is everywhere. And everywhere you learn that the young — high schools and up — while as well as Negroes are not only aware of the issue but are out with picket lines for the march on Washington the 18th of this month.

But one domestic phenomenon creaks along like the one-hoss shay. Though it owns all the advantage of supersonic techniques, its meaning and content are way behind the times. I speak of our nation's press. The newspapers are dismal — by and large, with few exceptions, and these, perhaps not too honorable.

Pick up a paper in Chicago and it is a spilling image of the paper in Seattle; buy one in L. A., and you can't remember if you saw it or a dead ringer for it in San Francisco. Change the style of type a bit, and you have the same paper; the same columns, the same columnists, the same editorials, the same general line of thought. How far can a national phenomenon, so big and so mighty, fall behind?

The people, at my meetings, realized that the national phenomenon, so big and so mighty, had fallen behind.

to get going on building their own press. Seattle, for example, where they raised over a thousand dollars for the People's World at the meeting; Portland, for example, where a twenty-one year old chaired the affair; L. A., where some 2,000 came, and where the Veterans of the Lincoln Brigade made your correspondent feel like he did twenty years ago when he met many Americans for the first time. And in Chicago, in Detroit, in Cleveland, they were getting ready to go off to Washington to say Americans refuse to starve; and, a little later, to Washington again to say Americans refuse to segregate.

YES, THERE IS an air of big things happening and bigger impending. I have the feeling that the march of history is on the double-quick; and that those who wish to influence it to avoid the booby-traps, the pitfalls, need to

step their pace up to keep time. Somebody by the initials of G. A., in San Francisco, wrote a letter to the People's Voice that merits thought: "I had only one regret about the Joseph North meeting in San Francisco" — G. A. wrote, "There should have been more people there."

The writer said he was sure many who didn't come "are sympathetic to the Cuban revolution" and would be opposed to any intervention against the Cuban people.

"Yet, some people — presumably in the name of opposing narrowness and rigidity — have gotten so narrow, rigid and intolerant in their own outlook that they would not turn out for this meeting about and for the Cuban revolution."

There is ironic tragedy in the fact; the moral belongs to the familiar maxim that tells us what the road to hell is paved with.

(Continued on page 11)

Joseph North

(Continued from page 9)

with. To be for the Cuban people — and to do nothing about it while intervention — open or concealed — threatens, helps nobody but Batista and his backers.

★
YES, IT IS HIGH TIME that our press is put on firm foundations and made strong again to cope most ably with the times.

It is my belief that can be done and as fast as the times require. Although G. A. of San Francisco spoke some real truths, there was a twin phenomenon many commented on who know the audiences. That is this large numbers in the halls came who hadn't been to a meeting in several years. Many such as these can be made readers of our papers once again, I believe.

And beyond all else, I feel is the need to get new readers, those who never came to meetings before. They are here and should be sought out. They have a simple and insatiable desire to live and most of the newspapers have no answers to their questions. They are waiting for you.

THE WORKER

APRIL 26, 1959

page 11 column 5

by the monopoly press which threw the... committee into the wastebasket. There was... campaign. And not least, there was the question of... who vowed last Oct. 25 when Eisenhower snubbed... would come back with twice the number, more than... proved in action that they are determined to continue... national march co-ordinator, expressed this when... would keep coming to Washington in increasing... their demands were met.

★
Desegregation has come to a virtual halt. Six southern... no move to begin desegregating schools but are... st... tions program of the Youth marchers calls for pass... Javits civil rights bill, continuing the petition drive... Asbury Howard Jr.

... step for... noble cause... I also quest... prospect is... seen, the Am... lions. He bla... aders, heading... Confederati... nians for in... tently relat... America.
"We consid... at there shou... een busines... her groups... rkers. And... American... cts."
Soloviev said

Castro

(Continued from page 1)

Guevara, one of his closest aides, was quoted by press news dispatches from Havana (N. Y. Times, April 20) warning that "foreign influences are trying to prevent the success of the Cuban Revolution."

Guevara has been the target of a heavy attack as "a Left-wing aide" of Castro's. He said in a speech closing an industrial exposition, that representatives of "non-Cuban capital" are dangerous and "oppose Cuban industrialization and land reform."

The N. Y. Times said Guevara "professed" to see parallels between Cuba and Guatemala: the Arbenz government was "moderate," but a "defamatory campaign" was carried out, the Government was "accused of being Communist," and "was toppled by an invasion financed from abroad."

★
LATIN AMERICA knows the parallel all too well: there is scarcely a citizen of the 200,000,000 in the lands south of the Rio who doesn't know the role of the late Ambassador John Peurifoy and of United Fruit in financing the overthrow of the Arbenz government. And they have more than legitimate fears that a repetition is being plotted by similar forces in the U. S. A. today.

Meanwhile Castro was being belabored by the newspapers and other public agencies here who were trying, by hook or crook, to jockey him into a position where they could brand all guns on him, and hence, the Cuban revolution. Much of what he said was published out of context, as the U. S. newsmen questioned him, ad nauseam, about "Communists in Cuba", about his reason for assailing dictatorships like San Domingo's, whether Cuba was planning "to invade" those lands, about his position on neutralism in case of war, about expropriating U. S. corporations now in Cuba, about the

date for elections in Cuba, etc. etc.

It was ironic that he was under fire from such ardent democrats as Sen. Smathers of Fla., where the great Negro populace does not find it healthful to exercise their constitutional right to vote. After Smathers damned Castro with faint praise as "a courageous and articulate young man," he thundered that the Cuban premier hasn't "yet learned" that "you can't play ball" with the Communists.

Smathers and others like him weren't satisfied with the Cuban leader's explanation that "95 percent of Cuba" participated in ousting Batista, including, of course, the Communists of Cuba, thousands of whom fought in the rebel army and in the patriotic underground against Batista — the Caribbean Hitler.

Nor was it enough for Castro to declare as he has before, that he is no Communist. Nothing would satisfy the neanderthals but a McCarthy-like tirade against Communists, or those described as Communists or pro-Communists — the terms used so frequently by enemies of the new Cuba for such men as Castro's brother, Raul, or his close associate, Major Guevara, and many other Cubans.

MEANWHILE reports indicate that the U. S. Congress will refuse to raise the reduced quota of Cuban sugar, and evidence was aplenty that loans from U. S. corporations would be used as clubs to try to bring the new Cuba to its knees.

Meanwhile hundreds of thousands of Americans were watching every detail of Castro's visit here, with enthusiasm and concern.

New Yorkers were preparing, as this edition goes to press, to attend — in scores of thousands — the demonstration welcoming Castro in the Mall in Central Park Friday.

On Tuesday throngs estimated at 20,000 by the Daily News and the Daily Mirror, greeted Castro at Pennsylvania Station. Thousands of others greeted him at other points during the day.

The WORKER
APRIL 26, 1959
Page 1 Column 1, 2, 3, 4, 5

The WORKER
APRIL 26, 1959
Page 16, Column 4, 5

b
b
b
b

SEARCHED	INDEXED
SERIALIZED	FILED

b3
b6
b7C
b7E

A-6
X

THE EVENING STAR
Washington, D. C., Friday, May 29, 1959

New Castro Stand on Reds Encourages U. S. Officials

By JOHN V. HORNOR
Star Staff Writer

Highly placed officials here say they are encouraged by the firmer stand taken recently by Cuban Premier Fidel Castro against the Communist Party.

The role of Communists in the Cuban revolutionary government has been a matter of concern to Western countries ever since Mr. Castro came into power last January. This was due in part to the readiness of Communists to latch onto the Castro forces as soon as Dictator Fulgencio Batista was overthrown and in part to Mr. Castro's reluctance to repudiate the Reds publicly.

Many questions relating to these facts were raised when the youthful, bearded Prime Minister visited the United States in April. His comments then were not responsive, in the opinion of many Americans.

The Picture Changes

Recently, however, Mr. Castro's attitude has been more acceptable to the West. He has reprimanded the Communist Party in Cuba and has been bitterly assailed by its spokesman. Furthermore, his followers have consolidated their control of the vital labor organizations, much to the resentment of the Communists.

A few days ago, the Federation of Cuban Sugar Workers passed resolutions denouncing the Reds and within the last week Gen. Blas Roca, the Cuban Communist Party secretary, heatedly complained that Mr. Castro's "strong anti-Communist campaign" threatened the unity of the forces supporting the revolution at a most critical time.

Anti-Communist feeling has

INTERPRETIVE REPORT

been running so high that the Castro government found it advisable to throw a guard around the newspaper plant of Hoy, the Communist publication. Some Castro followers had demanded that the plant be burned.

Red Threat Still Present

Prime Minister Castro's official stand against the Communist Party does not mean the Red threat is eliminated, according to well-informed observers. There remain Communist sympathizers in many key places, including membership in the 26th of July Movement. This is the designation of the Castro revolutionary forces.

Officials say Mr. Castro does not now enjoy as much support in Cuba as he did when he overthrew the Batista regime.

This is considered natural, inasmuch as each act of the provisional government is bound to displease some citizens while pleasing others.

Government is being run by decree. The Castro cabinet decides on policy and executes the rulings.

This leads to a measure of discontent for the people have had no chance to elect a legislature of lawmakers. But Mr. Castro says he is convinced a number of things must be done in the social and economic fields before the public is ready to vote in a general election.

The Prime Minister has estimated that elections should not be held from two to four years following his assumption of power. This delay leads some observers to believe that he will face mounting pressure to authorize a vote.

Reform Plan Watched

One of Mr. Castro's decisions which was of vital importance to American investors was the recent announcement of a plan for "agrarian reform." The unofficial formula already announced would result in the expropriation of perhaps 1.5 million acres of land now held by American interests.

The tentative plan of the Castro government is to pay for these with 20-year bonds with an interest rate of 3 to 4 per cent. But the exact terms have not been divulged and no one knows for sure what to expect.

Some investors entertain hopes that there will be modification in the land reform plan before the official version is made public.

Among the popular gains credited to Prime Minister Castro are his actions leading to reduced rentals, power rates and cost of medicines, and less speculation in real estate.

SEARCHED	INDEXED
SERIALIZED	FILED

b3
b7E

C

Bombs Explode As Castro Talks

HAVANA, June 18 (AP).—Bombers went to work in Havana while Prime Minister Fidel Castro was making a television speech last night. Police said four homemade bombs were exploded, most of them in doorways of small shops.

There was little if any damage and no injuries were reported. The explosions were reminiscent of tactics used by Mr. Castro's Havana followers in the underground campaign that helped to unseat Dictator Fulgencio Batista.

The bombs, made from short lengths of pipe, were of a type more notable for their noise than their destructive power. They were fired in areas of the city away from the TV studio and Mr. Castro made no mention of them in his telecast.

Mr. Castro told his TV audience he would "unmask" elements of the press he accused of campaigning against his government.

Obviously nettled by editorial and other criticism of his land redistribution program, he said the newspapers would prefer to forget the "corrupt past and all the immoralities of past governments."

He did not explain what action he plans against the press. But he said a million rural people would be brought to Havana soon for a rally in support of agrarian reform.

Referring to a local newspaper report that he had hired a New York publicity firm at \$72,000 a year to "make Castro known to Americans," the Prime Minister said the firm was hired to combat foreign press "intrigue."

Mr. Castro also said foreign properties would not be touched this year in the implementation of his land-reform program.

[Redacted]

SEARCHED.....	INDEXED.....
SERIALIZED []	FILED []
JUN 19 1959	

[Redacted]

b3
b6
b7
b7

C

THE WASHINGTON POST and TIMES HERALD
A.6 Friday, June 19, 1959

Castro Regime Purges 26 Top Air Officers

HAVANA, June 18 (UPI)—Premier Fidel Castro's government has purged 26 top officers of the air force in an apparent "loyalty" housecleaning, informed sources disclosed to night.

The ousted officers, who included Air Force Cmdr. Maj. Pedro Diaz Lanz and his brother, Capt. Marcos Diaz Lanz, were virtually all of Cuba's experienced flying personnel.

Informed sources said the purge took place last Friday but was hushed up. It was carried out by Maj. Juan Almeida, an infantry officer who fought with Castro in the Sierra Maestra mountains during the civil war.

Private pilots were ordered today to obtain special authorization from military headquarters for all flights in private planes, the Associated Press reported. No reason was given.

In another move to check counter-revolutionary activity, Justice Minister Alfredo Labur told newsmen he would propose that the government exact the death penalty for anyone convicted of illegally exploding bombs.

Last night and early today four bombs exploded in the greater Havana area in the first outbreak of terrorism since the triumph of Castro's revolution Jan. 1. Two persons were injured slightly in the blast.

The explosions occurred between 11 p. m. and 1:40 a. m. while Prime Minister Castro was expounding on economic policies in a television program.

Castro announced plans for mass meetings in Havana of more than 500,000 peasants from the interior on July 26—the anniversary of the founding of his revolutionary movement—and called on the people to open their homes to shelter them.

Castro defended the hiring of the New York public relations firm of Bernard Reilly and Associates Inc. for \$72,000 a year and expenses, "to defend the credit of Cuba, not to publicize me."

Meanwhile, hundreds of foreign residents stood in a block-long queue to acquire Cuban army intelligence exit permits, which, for the first time in Cuban history, are now required for trips abroad.

SEARCHED.....INDEXED
SERIALIZED FILED
JUN 19 1959

b3
b6
b7C
b7E

C

THE WASH. POST & TIMES HERALD
Page 17 Date 6/22/59

**Castro Aide Meets
With Kubijschek**
N. Y. Daily News Service
RIO DE JANEIRO, June 21—Fidel Castro's defense minister, Augusto Martinez Sanchez, conferred secretly over the weekend with President Juscelino Kubitschek, it was disclosed today. Cuban Ambassador Garcia Barcena confirmed the mystery meeting but said he did not know if Sanchez carried a message from Castro to the Brazilian Government.

[Redacted]			
SEARCHED	INDEXED	[Redacted]	
SERIALIZED	FILED	[Redacted]	
[Redacted]			

b3
b6
b7C
b7E

C

AY

Castro Seizes 2,355,242 Acres Of Ranch Land

HAVANA, June 26 (AP).—Prime Minister Fidel Castro has cracked down on the loudest critics of his land redistribution program, seizing 2,355,242 acres of cattle ranch land.

Mr. Castro sent troops to 400 ranches in Camaguey Province to occupy land belonging to 131 cattlemen. He said they had refused to pay small breeders profitable prices for their cattle.

Mr. Castro acted under government powers to take over property used for counter revolutionary activities. Although the seizure was not made under the land reform law, the ranches eventually will be distributed to landless peasants. Each is in excess of the maxi-

mum 3,300 acres allowed an owner under the land law.

Mr. Castro had warned the cattlemen he would take action. They have been among the chief critics of his land program, claiming efficient cattle raising is possible only on large ranches.

[Redacted]

SEARCHED [] INDEXED []
SERIALIZED [] FILED []

JUN 29 1959

[Redacted]

b3
b6
b7C
b7E

THE WASHINGTON POST and TIMES HERALD

A.6

Wednesday, July 1, 1959

Cuba's Air Chief Quits; His Arrest Is Ordered

HAVANA, June 30 (AP) — The commander of Fidel Castro's air force resigned today, charging Communist infiltration of Cuba's armed forces. His successor accused him of being a traitor to Castro's revolution and ordered his arrest.

Maj. Pedro Luis Diaz Lanz sent his resignation to President Manuel Urrutia. Diaz had resumed his post yesterday after a month's absence which was attributed to typhoid fever.

Maj. Juan Almeida, who had

commanded the air force in Diaz's absence, was named to succeed him.

The whereabouts of Diaz could not be learned tonight. There was speculation he had gone underground or left the country.

Almeida announced the order for his predecessor's arrest after a conference with Castro and his brother, Maj. Raul Castro, commander in chief of the armed forces.

Almeida accused Diaz of (1) desertion, (2) treason, (3) "robberies," and (4) being in contact with members of ex-dictator Fulgencio Batista's regime.

Almeida said Diaz had been under investigation for crimes to which he must answer before the revolutionary tribunals.

Diaz's resignation was the first by a government official on such grounds. Castro has repeatedly denied charges of Red influence in his government.

In a letter to Urrutia, Diaz said that on returning to his office Monday he found Almeida had been made absolute chief of the air force.

"I consider all these actions against me due only exclusively to the fact that I have always opposed acts that would permit Communists to take prominent positions within the rebel army and within dependencies of government," Diaz's letter said.

"Furthermore, all of us know well, Mr. President, who they are, where they are and what objectives they follow."

Questioned earlier today about rumors of Diaz's leaving his post, Premier Castro's press secretary said reports that Diaz had been dismissed are not true.

In another development, a police raid on the swank Havana home of a former U. S. Navy pilot last night frustrated a planned air and sea invasion of Nicaragua, official sources said tonight.

The raid was on the home of Capt. Paul Hughes, former Atlanta, Ga., pilot and recently an advisor in the Cuban rebel air force.

It led to the seizure of a



Associated Press Photo

MAJ. PEDRO LUIS DIAZ LANZ
quits air post

large arms cache and air-sea invasion plans and the detention of two other Americans, a British journalist, several Cubans, and nearly 200 would-be members of an expeditionary force against the regime of Nicaraguan President Luis Somoza, official sources reported.

The British subject was identified as Carl John Wilson, a freelance journalist, who has been in Havana several weeks.

The two Americans detained with Hughes were identified as Effen R. Richardo, an attorney of Miami, and Joseph Bardor of Los Angeles, who claimed he is a motion-picture producer.

More than a dozen of the 200 volunteers—mostly Nicaraguans—were held while the remainder were released with a warning.

No charges have been placed against Hughes or any of the others.

In Florida, customs agents today seized a load of arms and ammunition at a private airport, stopped a small plane as it taxied off and arrested three men described as anti-Castro plotters.

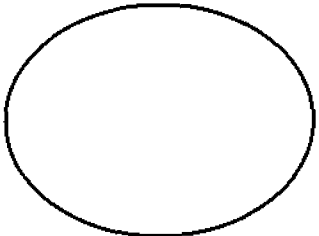

[Redacted box]

SERIALIZED [] FILED []
JUL 1 1959
FBI WASH F O

[Redacted box]

b3
b6
b7C
b7E

AF Chief Quits; Called 'Traitor' Cuba Purge On

HAVANA, July 1 (UPI)—The Cuban government today branded its resigned Air Force chief as a traitor and a deserter and was purging his followers in a major rupture of the revolutionary movement that carried Fidel Castro to power.

Maj. Pedro L. Diaz Lanz, chief of the Cuban air force, resigned yesterday in protest against what he called communists in high positions in the Castro government. President Manuel Urrutia in a midnight statement called him a traitor.

The government also dismissed Aldo Vera as head of the Bureau of Investigation in another breach of the revolutionary front and ordered wholesale disarming and arrests of Sr. Vera's men. Sr. Vera was reported under detention but Sr. Diaz Lanz whereabouts were unknown.

As many as 30 army and air force officers were reported under arrest in addition to many members of the Bureau of Investigation.

HOSPITALIZED

Finance Minister Rufo Lopez Ercequist was reported hospitalized and unable to receive visitors. His views of Cuba's tax reform laws had been criticized by other cabinet ministers as "over-conservative."

Sr. Diaz Lanz complained he had returned to duty as chief of the air force Monday after a sick leave, to find he had been superseded by Maj. Juan Almeida, a confidant of Raul Castro, leftist chief of the armed forces and brother of Fidel.

Sr. Diaz Lanz charged this was in retaliation for the fact "I have always spoken out against the (official) attitude which permits communists to occupy prominent positions in the rebel army and in other dependencies of the government."

Police Chief Efigenio Ameijeiras branded Sr. Diaz Lanz a "traitor and a deserter."

Raul Castro said he and the officers that supported him were just "young dandies" and that men like Maj. Almeida "are what we need here."

President Manuel Urrutia

issued a statement later saying Sr. Diaz Lanz "must be considered a traitor." He charged Sr. Diaz Lanz was resentful because Maj. Almeida had fired some of his relatives.

In other developments:

RAIDS REPORTED

• Police raided a private home in suburban Biltmore yesterday, seized a large quantity of arms and arrested three Americans and a Briton. The Americans were identified as Paul Hughes, an officer in Castro's rebel army; Efrén R. Pichardo, of Miami, Fla.; and Joseph Bardou, of Los Angeles, Calif. The Briton was listed as Carl John Wilson.

• Four men and a woman



RAUL CASTRO

were arrested in Pinar Del Rio on charges of conspiring to overthrow Castro's government, but 15 army officers who were arrested June 22 were released.

• Government attorneys were instructed to file criminal libel complaints against Cuban columnists Carlos Todd of the Times of Havana and Bernardo Viera of the newspaper Avance on charges of defaming the president.

WASHINGTON DAILY NEWS
Page 7 Date 7/1/59

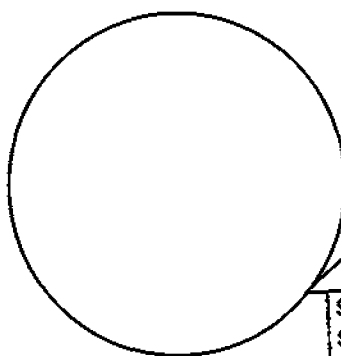

SEARCHED	INDEXED
SERIALIZED	FILED
JUL 1 1959	
FBI - WASH. F. O.	

b3
b6
b7C
b7E

Opposition Grows

Armed Bands Form in Cuban Mountains

HAVANA, July 2 (UPI)—Armed guerrilla bands are forming in the mountains of western Cuba, it was reported today, and the army is trying to smash them before they gain enough strength for an all-out assault on the Castro government.

The new threat came at a time when the so-called "revolutionary unity" of the government was seriously threatened by a wave of arrests and resignations in the air force and national bureau of investigation.

MISSING

Police were conducting a vigorous hunt for Maj. Pedro L. Diaz Lanz, who resigned as chief of the air force in a bitter protest against communist infiltration of the government.

Lieut. Enrique Montes de Oca, head of the investigations department of the army in Pinar Del Rio province, confirmed the existence of the armed bands yesterday.

He said they were operating in the Organos range, about 11 miles from Pinar Del Rio city.

Premier Fidel Castro's revolutionary army was reported to have thrown 1500 to 1700 men into the campaign to smash the groups. They were said to be operating from the Guanito and Sumidero camps, situated in the mountain range.

REPEAT

Castro's own revolution, which overthrew Dictator Fulgencio Batista Jan. 1, was spawned and launched from the opposite end of the island, the Sierra Maestra mountains of Oriente Province.

Reliable sources said many men who served in the army under Batista had fled to the Organos mountains in the

past few days to join the anti-Castro groups.

Just as Castro found his support among the peasants of Oriente Province, Pinar Del Rio appeared to be a natural rallying place for resistance to Castro.

Pinar Del Rio tobacco farmers have threatened openly to fight to the death to prevent the Castro government from carving up their farms under the new land reform program. They include some who supported the Castro revolution.

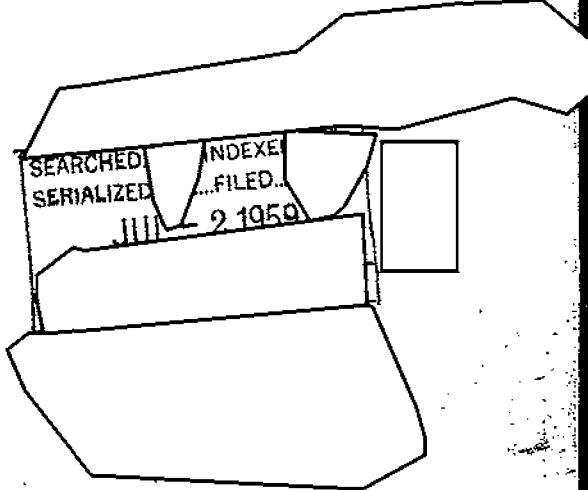

b3
b6
b7C
b7E

RALPH MCGILL

A13

Cuba Needs Castro to Succeed

Political Revolutionist Viewed as Hope Of People to Ease Their Inequities

HAVANA, Cuba.—Here, seeing Fidel Castro's bearded soldiers strolling along the Prado, and on the streets of this ancient and beautiful city, one thinks of the Pageant of History.

Cuba has had her share—Columbus, Diego Velasquez, Cortez, De Soto, pirates, and British and Spanish rule.

Now, in the long pageant, appears Fidel Castro.

His story is too new to belabor. But let us recall, in this attempt to find understanding, that this is his second appearance on the stage of Cuban history. His first was very brief. On July 26, 1953, he led a small group of 75 men in a desperate attack on the Moncada fortress near Santiago de Cuba. It failed. Castro was arrested. Plots to kill him were thwarted by friends, and the court, not yet dominated by the Batista forces, heard Castro's defense. This was more than five years ago. None of it was then permitted to be published.

In a long, eloquently written defense, Castro said—almost six years ago:

"We call on the people, the 700,000 Cubans who are without work . . . the 500,000 camp workers who dwell in miserable shacks, who work four months out of the year and are hungry the rest, sharing the misery with their sons, who do not have an inch of land to plant and whose existence should move more to compassion if there were not so many hearts of stone; the 400,000 industrial workers and stevedores whose retirement funds, all, have been embezzled . . . whose

salaries pass from the hands of the boss to the usurer, whose future is a pay reduction and dismissal, whose life is perennial work, and whose rest is the tomb. We call on the 100,000 small farmers who live and die working a land that is not theirs . . . who die without possessing it, who cannot love it, nor improve it, nor plant a cedar or an orange tree to beautify it because they do not know the day when a sheriff or rural guard will come and tell them they have to go . . ."

Castro was 27. He spoke for more than an hour. The judges heard him out. They then sentenced him to 15 years at hard labor. His first appearance in the pageant of history was ended.

A year later the story of the attack, the atrocities, un-denied, against some of the captives, became known. So did Castro's eloquent, emotional words. On May 16, 1955, he and the survivors were released from prison after long agitation for an amnesty. In January of the next year he and 12 men reached the Sierra Maestra mountains. He was once more in the pageant.

The pageant will continue through the centuries ahead. Fidel Castro is an episode . . . a new type revolutionary, a political revolutionist, not a military. The odds tremendously are against him. But if he does not succeed, it is not comfortable to consider the next scenes in the pageant.

Americans, who are themselves heirs of revolution, fall into a common human error of comparing everything with

their present situation, laws, customs and comforts.

Here is why the odds are heavily against Castro: The labors of Hercules are less in comparison.

Most of his people are dependent on agriculture—perhaps 60 per cent of them. Most of them are landless. The average yearly earnings of thousands of them is less than \$100. This is true not merely in Cuba, but all Latin America. Cuba is but one of those in the spotlight. The long-term issue is not Castro—but the stability of Latin America. It is not now Communist. There is no head of a government who is Communist.

But even Castro cannot stem the tide of discontent if he cannot remove some of the inequities which have so long been smoldering in the minds of millions of Latin peoples.

Something like one-quarter of the world's population of more than 2.5 billion people today live in what can be called rich countries. These peoples average a per capita income of about \$1,000 per year. These peoples are mostly the Europeans, the Americans, Canadians, Australians, New Zealanders and so on.

From somewhere between a half and three-quarters of all the people in the world are definitely and excessively poor with an average income of about \$100. There are at least three with this income for each making \$1,000. And the gap between "have" and "have not" nations widens fearfully—ominously.

This is the problem of Cuba—but it is also that of other Latin countries and of Asia.

It is against this backdrop we must see Castro—and the continuing pageant—if we are to understand.

b3
b6
b7C
b7E

b3
b7E

C

Cubans Say 4 From U.S. Seek to Kill Castro

HAVANA, July 12 (AP) — Members of the Cuban Cabinet said today they have been informed that four assassins are en route from the United States to kill Prime Minister Fidel Castro, his brother Raul and four Cabinet members.

The informants, who asked not to be identified, said the gunmen were being sent to assassinate Finance Minister Rulo Lopez Fresquet, Commerce Minister Raul Cepero Bonilla, Public Works Minister Manuel Ray and Faustinó Perez, Minister for the Recuperation of Stolen Public Property, as well as the two Castros.

Cabinet members, who usually carry arms, said they had been instructed to take extra precautions in view of the reports. The Cuban intelligence service was reported to be investigating the reports.

Castro made no reference

to the plot during a 2½-hour television speech against alleged United States interference in Cuban affairs last night. There were no outward signs that his normal complement of body guards had been reinforced.

The reports seemed to resemble those that plagued Castro and his associates on their trip to the United States and Canada last April. Unprecedented protective measures were taken for Castro in some of the cities he visited including New York.

Scores of threats against his life were made during the trip. A young man carrying a home-made bomb was arrested as Castro addressed a Central Park rally in New York April 24. The bomb wielder was quoted as telling police he intended to set off the device "for excitement" and meant no harm.

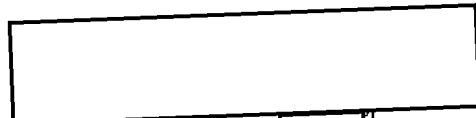

SEARCHED INDEXED
SERIALIZED FILED
JUL 13 1959
FBI WASH. F.

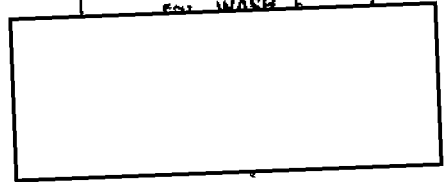

C

THE WAS

'Soviet Instrument ... Horrible Damage to Cuba' Cuba's President Charges Reds Are Plotting 'Treason'

HAVANA, July 14 (UPI)—President Manuel Urrutia last night accused the communists of plotting "treason" in Cuba. The charge set the stage for an internal power struggle between right and left in Fidel Castro's revolutionary government.

It added up to new trouble for the regime already beset by dissensions in the armed forces and national police and threatened by "counter-revolutionary" conspiracies being uncovered throught the country.

TOOL

Sr. Urrutia, who has been seething quietly at communist tactics in Cuba since the Castro revolution succeeded Jan. 1, went on television to denounce the communist newspaper, Hoy, which had criticized him. He labeled it a "Soviet instrument in the cold war."

He said the communists were going "horrible damage to Cuba" trying to create a second front against the United States and in favor of Russia.

His words were by far the harshest anyone in the Castro regime has used against the communists. Premier Castro himself has refused to



PRESIDENT URRUTIA

condemn them, saying only that he welcomed anyone who worked for his revolution.

But Sr. Urrutia insisted, for the second time in two days, there were no differences between Castro and him. He said such reports were "counter-revolutionary."

Dr. Castro reserved his harsh words for the U.S. Senators who have been taking information from Maj. Pedro L. Diaz Lantz, former chief of the air force who fled to the United States after charging there were communists in the Cuban government.

Dr. Castro called the Sen-

ators "political simpletons ... (who) seek to put a premium on treason."

UNITY

President Urrutia agreed with Castro that Maj. Diaz Lantz should be returned here for trial. He called the former air force chief a "despicable traitor." Maj. Diaz Lantz was one of Castro's strongest supporters during the revolution. His break with the regime was the first evidence of a crumbling of the so-called "revolutionary unity" of the armed forces.

The Castro regime has launched an intensive campaign against what appears to be either a concerted nationwide plot or a series of conspiracies to overthrow his government.

Matias Rodriguez Rivol, a lieutenant in the army of ousted dictator Fulgencio Batista, was arrested with three other former soldiers in Pinar Del Rio yesterday on charges of counter-revolutionary activities.

Meanwhile, Cuban Consul Alonso Hidalgo said he intended to sue Miami officials for injuries he suffered there during the July 4 rioting by rival Cuban factions.

Sr. Hidalgo, who was arrested by Miami police during the rioting, said he was hit by police and followers of Batista.

[Redacted]

SEARCHED _____ INDEXED _____
SERIALIZED _____ FILED _____
JUL 14 1959

[Redacted]

b3
b6
b7C
b7E



Dorticos Led Civil Resistance

HAVANA, July 18 (UPI)—Cuba's new president, Dr. Osvaldo Dorticos, is a medium-sized man, with a small mustache. He wears horn-rimmed glasses. He is 45, and a native of Cienfuegos in Central Cuba's Las Villas province.

He graduated with a law degree from Havana University and had a successful practice going before his ideals led him into Dr. Castro's 26th of July Movement as a leader of the civil resistance.

Forced into exile in Mexico by the Batista regime, Sr. Dorticos remained there until the Castro victory.

He was named to the original revolutionary cabinet with the job of drawing up law decrees to implement Dr. Castro's various reform programs.

Sr. Dorticos is married to Maria Caridad Molina. They have no children.

He had been among the less frequently named possibilities to succeed Sr. Urrutia in the speculation touched off yesterday when Dr. Castro announced his resignation.

SEARCHED		INDEXED	
SERIALIZED		FILED	
JUL 18 1959			

b3
b6
b7C
b7E

Castro's Choice

A14

THE WASH. POST & TIMES HERALD
Page A14 Date 7/20/58

Fidel Castro, by forcing Manuel Urrutia out of the presidency and putting Osvaldo Dorticos Torrado in, has demonstrated once more that he is the absolute personal chief of the Cuban government with unlimited power. The dramatic and sensational television appearance by which he blasted Urrutia out of office was aimed at Castro's enemies, but it must dismay his friends more than it dismays his enemies. Such tactics can only cause a certain uneasiness among all those with memories long enough to recall other personal rulers of our generation who have driven foes out of office by hours-long vituperative oratory.

Castro may or may not be mistaken about Urrutia. Perhaps the former President did obstruct the known revolutionary goals of the regime. Were Castro to consult his predecessors in personal rule, however, he might discover that regimes of this kind are more menaced from the inside by those who agree with the ruler than by those who disagree with him. The Castro regime seems to have enough sheet so that it could have afforded an anchor.

If we cannot be sure of our judgment about Urrutia, we can be sure that Castro is misjudging the United States. This country has no motive for any other wish than that Cuba's new government may succeed in its difficult tasks. There is a reservoir of good will here for the revolutionary movement that overthrew a regime widely detested for its excesses and abuses. There is good will, too, for the unfortunate people of Cuba who have not had the good things of the modern world that sound economics and sound government should be able to give them. Furthermore, it is apparent to people here that Castro earnestly wishes to improve the lot of his people. Yet unlovely demonstrations of personal power, such as those of the week-end, are making heavy drafts upon this good will and belief.

Patience is necessary while the new regime is working out its problems. Land reform and wage changes are not the most revolutionary alterations Castro has introduced. Even more revolutionary is his effort to introduce honesty in Cuban governmental affairs. The first experiment with integrity in office is bound to be difficult in a land where one regime after another has bought its adherents with bribes, favors and corruption. Castro has a hard job. He needs help and understanding, and he will get both, if he can avoid chaos and the kind of arbitrary rule that stifles freedom. He has a great opportunity to set some long-awaited precedents in Cuban affairs. If he succeeds, his impact upon future events in this hemisphere certainly will be great.

It is to be hoped that he now will turn to this purpose, and that he will abandon a competition with better forgotten ghosts of history that he can never equal for length and violence of speech.

SEARCHED INDEXED
SERIALIZED FILED
JUL 20 1958

b3
b6
b7C
b7E



--UPI telephoto.
This farmer with his machete has become something of a symbol of the Castro revolutionary regime. He is one of thousands who have gathered in Havana for the July 26 anniversary of the revolutionary movement.

PEASANTS CROWD INTO HAVANA

Cuba's Cabinet Maps Future Minus Castro

HAVANA, July 21 (UPI) — The Cuban Cabinet worked into the early hours this morning charting the future of the revolution under Cuba's new president, Osvaldo Dorticos Torrado.

Fidel Castro did not attend the meeting.

IN SECLUSION

Since he forced the resignation of President Manuel Urrutia on Friday night the bearded Dr. Castro has kept pretty much out of sight, spending at least part of the time in seclusion on the Isle of Pines.

There was some speculation that Dr. Castro might delay his formal return to directing the affairs of state until Sunday when hundreds of thousands of Cuban peasants will celebrate the sixth anniversary of the start of his rebellion against Fulgenio Batista.

Thousands already were in the capital and more were

arriving every hour on foot, horseback, by bus and train.

Government officials set up guided tours of the city for groups of 50 or more. Among the sights pointed out were the Presidential Palace, luxury hotels and American tourists.

Jules Dubois, Chicago Tribune correspondent, in a dispatch from Havana, said Dr. Castro doesn't plan to return as premier, and has told friends he wants to give full time to agrarian reforms.)

Peasants aroused by Cuban newspaper denunciations of American newsmen, caused some bad moments for two American photographers, Andy Lopez of United Press International and Bob Blair of NBC-TV.

DIFFICULTIES

Mr. Lopez asked a Cuban selling straw hats to pose in front of the Capitol. A bystander told two plainclothesmen he had asked the hat salesman to pose with his left fist in the air in a communist salute.

Mr. Lopez was taken to the tourist police station, his film was developed and he was released.

Mr. Blair was working about a block from the Presidential Palace when a group of peasants stopped him and took his camera. Several bearded rebels retrieved it, returned it to Mr. Blair and then escorted him to the palace.

SEARCHED _____ INDEXED _____
SERIALIZED _____ FILED _____

JUL 22 1959

b3
b6
b7C
b7E

THE WASHINGTON POST Wednesday, July 22, 1959 A 9

Castro Out for Good, Friends Say

By Jules Dubois

Chicago Tribune Press Service

HAVANA, July 21 — Fidel Castro does not plan to return as Premier of Cuba and has told friends he wants to devote full time to the National Agrarian Reform Institute. He favors as his successor Regino Boti, now Minister of Economy.

Castro resigned last Friday in a successful move to oust Manuel Urrutia.

Boti accompanied Castro to the United States in April and then attended economic conferences in Buenos Aires and Panama.

Agrarian Reform is Castro's

pet project. He has staked the success of the revolution on it. He has been devoting most of his time and effort to organizing the vast and radical land reform program administered by the Institute.

Americans who have invested in resort land on the Isle of Pines will be allowed to retain 40 acres for recreational purposes only, Castro said. Many Americans have purchased property on that island which Castro hopes to develop as a major tourist center.

Friends say that Castro's refusal to return as Premier is partly motivated by not wanting it recorded that he may have affected a coup d'etat in

forcing Urrutia's resignation. More clamor for Castro to reconsider is expected. Whatever he does, he will still be the strong man and idol of Cuba.

In Havana a group of peasants brought into the capital for next Sunday's rally to honor the July 26 revolutionary movement was fired on from a speeding car. Police described the attackers as counter-revolutionaries. No one was hurt.

In Santiago an angry mob wanted to lynch 10 would-be conspirators arrested after a cache of explosives was found in a bar. Troops saved the arrested men.

[Redacted]

SEARCHED	INDEXED
SERIALIZED	FILED
JUL 22 1959	
FBI	

[Redacted]

b3
b6
b7C
b7E

Cuban Strike Is Called As Pro-Castro Gesture

HAVANA, July 22 (AP).—Cuba's giant Confederation of Workers (CTC) called a one-hour general strike tomorrow to demand that Fidel Castro return to the government.

CTC Secretary General David Salvador called on the confederation's million members to quit their jobs from 10 to 11 a.m. to make known labor's desire for the revolutionary chief to return as the government's leader in name as well as in fact.

Mr. Castro quit as Premier last Friday in a maneuver that forced out Manuel Urrutia as President. There has been talk since that he might put in a front man to look after the administrative details in which he has no interest while devoting his own time to his land reform program.

Announcement Expected

There is considerable speculation that Mr. Castro will announce his decision Sunday at the giant anniversary celebration of his July 26 revolution to which he has summoned half a million peasants from the provinces.

The cabinet held its first regular weekly session last night since Mr. Castro pulled out. He was not present, increasing speculation that he might not return to the job he said he did not want in the first place.

In an eight-hour session the cabinet (1) repeated its rejection of Mr. Castro's resignation and asked his return to the premiership; (2) created a commission to control stocks, bonds and other financial certificates, and (3) set up an-

other commission to control potato imports.

Typhoid Outbreak

An outbreak of typhoid fever was reported yesterday among farm workers gathered in Havana for the celebration of the revolution.

Havana newspapers said three typhoid cases were found among 800 farmers quartered on the Havana University campus.

Emergency medical units immediately vaccinated all 800 visitors.

Medical authorities feared the influx of thousands of people from rural areas, many of them unaccustomed to city life and habits, would create health and sanitation problems.

Earlier today the occupants of a speeding car machine-gunned an area near one of the peasants' temporary camps. A youth was hit in the leg.

Police said the incident was part of a stepped-up counter-revolutionary campaign to upset the Castro regime.

Ten persons were reported seized in Santiago with a cache of hand grenades and homemade gasoline bombs.

SEARCHED INDEXED
SERIALIZED FILED
JUL 23 1959

A 19

C

Today and Tomorrow

By Walter Lippmann

Cuba and Communism

SHORTLY after Dr. Castro brought his revolution to power in Cuba, the Governor of Puerto Rico, Mr. Muñoz-Marín, came up to Washington. He came to give us advice which he was pre-eminently qualified to do. For he had been carrying through successfully a peaceful revolution in his own country, he had the personal confidence of the Cuban revolutionists, and he was and is our very great friend.

Even then, at the beginning he foresaw the troubles in Cuba; the stubborn difficulties against which the revolution was waged and which it then inherited, the inexperience and the emotional instability of its fighting leaders.

Whatever you do, he said in effect, do not let yourselves become enemies of this revolution. For this revolution is the real thing. It is not a mere change of the guard at the top, as is so common in Latin America. This is a popular revolution of the sort which, more than 30 years ago, Mexico went through, and after years of blood and tears brought to a happy ending.

IT REQUIRES great skill to manage our relations with a revolution of this character in a country which is such a very near neighbor. We have to find ways of reconciling our political and economic interests with a revolution which cannot be stabilized until the chief grievances which produced the revolution have been redressed. This can be managed only if the American Ambassador in Havana can work out a relationship with the revolutionary leaders in which they will

listen to him, and even seek his advice and his help.

There is good reason to say that we have such an Ambassador in Havana, one who is capable of carrying out such a delicate mission, who has, one might say, "good hands" when he rides. But, of course he has no chance whatever of succeeding if Congress is going to rough-house our relations with Cuba, as did the Internal Security Subcommittee of the Senate just the other day. This was when it provided a platform and loud-speakers for a disaffected Cuban adventurer to denounce the Cuban revolutionists as Communists. This country, as the President was quick to point out, "has made no such charges." But the damage done by the subcommittee's irresponsible meddling may not be repaired easily or quickly.

THE POLICY which we are following in Cuba is to avoid a break with Dr. Castro and to seek more contact with him. This policy is the product of years of experience in our relations with the other American states. There is no alternative to it, given the fact that we have most solemnly renounced the right of intervention to suppress a revolution. In this century, we have committed ourselves repeatedly and wholly to the principle that each country in this hemisphere has the right of self-determination. This carries with it inseparably the right of revolution, and imposes upon us the obligation to live with the revolutions, when they occur, as best we can.

Beneath these large generalizations and abstractions, there is the substantial fact that in this century, which is seeing the awakening of the submerged masses of mankind, the old style of imperialism and overlordship is not only morally unacceptable but is practically impossible. To put it specifically

and bluntly, the United States could not install a puppet to govern Cuba in place of Dr. Castro and his revolutionists. The United States must, therefore, do what it can to keep on good terms with Dr. Castro and his successors.

THERE ARE those who think differently. They see Dr. Castro going far to the left in the company of a number of fellow travelers of the Communists. They think the way to deal with what they see is to denounce Dr. Castro who tolerates and associates with fellow travelers as himself a fellow traveler and virtually a Communist. What good will it do, I would like to know. The result of such tactics will not be to cause Dr. Castro and the fellow travelers to abandon their revolutionary program. It will be to cause them to regard us as their enemy, and to become as thoroughly anti-American as they dare to be.

The wiser course and the more practical one is to be patient and relaxed — to remember that Cuba is our nearest neighbor and is far beyond the reach of the Soviet Union. Remembering this, we can rely ultimately on the high improbability that Cuba will drift or be pushed and pulled into the Soviet orbit.

Just as it was a great mistake to treat Egypt under Col. Nasser as a Soviet satellite, so it would be an even greater mistake even to intimate that Castro's Cuba has any real prospect of becoming a Soviet satellite.

FOR THE THING we should never do in dealing with the revolutionary countries in which the iron curtain SERIALIZED SEPARATED FILED JUL 23 1959 WASH. F. O. even when they have been induced and subverted and drawn across the line, the right thing to do is to keep the way open for their return. (Copyright, 1959, New York Herald)

INDEXED	
FILED	
JUL 23 1959	
WASH. F. O.	

b3
b6
b7C
b7E

C

Pro-Castro 1-Hour Strike Of Million Set

HAVANA, July 22 (AP)—Organized farmer and worker support for Fidel Castro and his policies mounted today. The latest move to get Castro back at the head of the government came from Cuba's big Confederation of Workers.

David Salvador, Confederation secretary general, called one million workers out on a strike set for 10 to 11 am Thursday. This is intended to demonstrate labor's demand that Castro return as Prime Minister, a job he quit last week to force out Manuel Urrutia as President.

The Cabinet met last night without Castro and repeated its formal rejection of his resignation. There is no doubt that Castro remains the prime force in shaping government policies.

The farmer support came from a stream of at least 100,000 sombrero-wearing peasants arriving in the capital for a huge rally Sunday—the sixth anniversary of Castro's attack on a barracks at Santiago de Cuba. Castro's 26th of July Movement takes its name from the date of the attack.

The campesinos—rural workers—coming by bus, train, airplane and navy ship were the vanguard of the 500,000 Castro has called to rally here to support his agrarian reform program. The rally also is expected to chorus the demand that Castro come back as Prime Minister.

The first 100,000 produced a growing problem of feeding and housing. The presidential palace's hall of mirrors was filled with row after row of cots for the guests.

Meanwhile, attorney Raul Gomez Quintero, a revolutionary, filed a denunciation in Supreme Court against Urrutia, accusing him of treason. The lawyer said he wanted Urrutia imprisoned pending action by the government. There was no indication of the government's reaction to the denunciation.

SEARCHED	INDEXED
SERIALIZED	FILED
JUL 23 1959	

b3
b6
b7C
b7E

A 7

THE WASHINGTON POST

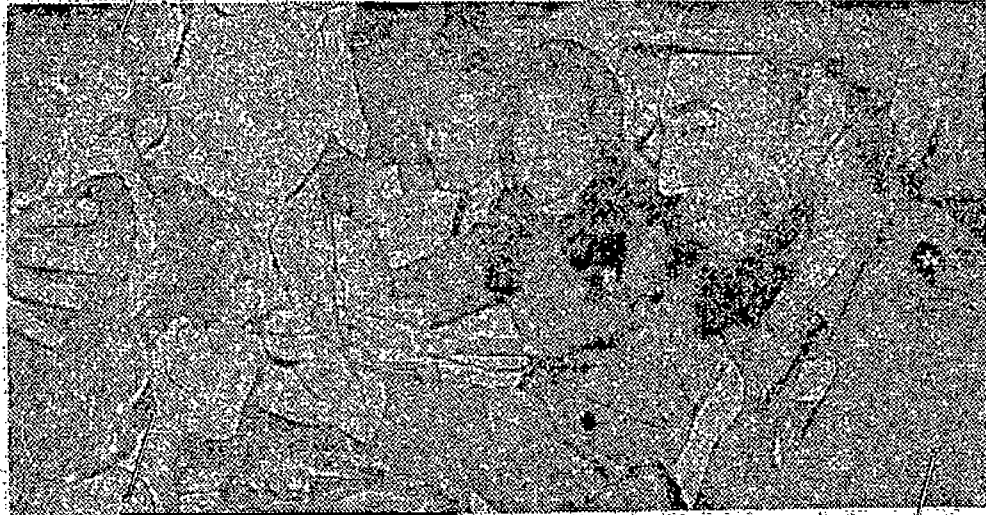

Associated Press Photo

Fidel Castro, Cuban leader, tweaks the nose of Doris Hernandez, 6, Wednesday after the girl read a poem on humanism at a meeting of a textile workers' union. It was Castro's first public appearance since he resigned as Premier.

b3
b6
b7C
b7E

b3
b7E

1-Hour Strike Ties Up Cuba

Havana, July 23 (AP)—Fidel Castro's supporters tied up Cuba today with a one-hour general strike called to support demands that he come back and be Premier. The bearded revolutionary said he'd withhold his decision until Sunday.

Today's work stoppage called by the million-member Cuban Workers' Confederation was part of a great buildup for Castro. He abandoned the top Cabinet post a week ago to castigate and expel Manuel Urrutia as President.

The campaign comes to a climax Sunday, when Castro's 26th of July movement celebrates the sixth anniversary of the start of the revolution against the now-fallen dictator-

ship of Fulgencio Batista. A huge rally is scheduled in downtown Havana.

"We'll let the people decide on the 26th of July," Castro told a rally early today. There was little doubt the people at Sunday's rally will "decide" Castro should return to office.

The ostensible purpose of Sunday's rally is to demonstrate support for Castro's pet revolutionary program, agrarian reform. He has called for half a million peasants—"campesinos"—and about 150,000 have already arrived for what now is being called a "vote of confidence."

"If they want to accuse me of anything," Castro said, "let them accuse me of having the people's support."

Thousands poured into the streets of Havana today to demonstrate for Castro. Starting on schedule at 10 a. m., workers in shops and factories left their counters and their tools for an hour.

The crowds halted all traffic, sometimes physically. Union drivers brought their big buses to a halt at either end of the three main tunnels into Havana under the Almendares River and Havana Bay. That tied up traffic there.

President Osvaldo Dorticos Torrado, who replaced Urrutia, joined the stoppage as the clock struck 10. He left his desk and went into the street to mingle with the crowds.

Clashes developed with some motorists. Two Cuban photographers were beaten while taken pictures during the strike — when work was supposed to stop.

Police identified one as Mario Bueno of Revolucion, Castro's official organ. One report said he was attacked when someone in the crowd claimed he had asked the campesinos to give a Communist salute.

Revolucion itself recently published a warning to the peasants against American photographers, who it accused of trying to persuade peasants to form clenched fists so that they could be photographed.

b6
b7C

SEARCHED [] INDEXED []
SERIALIZED [] FILED []
JUL 24 1959
FBI - WASH. F.



CUBA'S NEW PRESIDENT—Oswaldo Dorticos (left), newly named President of Cuba, embraces Raul Roa, Minister of State, shortly after he took over the reins of government. Mr. Dorticos, a country lawyer, succeeds Manuel Urrutia, who was forced out by Fidel Castro who accused him of conduct amounting to near treason.—AP Wirephoto.

New Cuban President Modest and Retiring



SEARCHED	INDEXED
SERIALIZED	FILED

JUL 18 1959



JUL 18 1959
FBI - WASH. F. O.

'Fidel, Come Back'

Castro Rally Steams Up

WASHINGTON DAILY NEWS
Page 4 Date 7/24/59

HAVANA, July 24 (UPI) — President Osvaldo Dorticos Torrado assured the Cuban people last night that Fidel Castro could not for long resist the mounting pressure they have put on him to return to the post of premier.

"His return to the leadership of the government is necessary for the definitive triumph of our revolution," Sr. Dorticos declared in a nationwide television appearance. He said he felt the will of the people is above Dr. Castro's "firm personal decision" to hold to the resignation he so surprisingly submitted a week ago.

Dr. Castro and a number of cabinet ministers were in the studio audience. The revolutionary hero is expected to announce at the mass peasants' rally in Havana this Sunday his decision to pick up the reins of office again.

Dr. Castro was scheduled to pitch tonight in a five-inning exhibition baseball game against his old friend and fellow guerilla fighter, Maj. Camilo Cienfuegos, commandant of Camp Liberty. The game was one of a number of festivities put on to entertain the thousands of farmers who were pouring into Havana for Sunday's rally.

An estimated 90,000 peasants streamed into the city yesterday, making a total of nearly 200,000 who already have arrived for the rally. Most carried machetes. Their

voices were expected to be raised in the unanimous cry "Fidel, come back" on Sunday.

The Cuban Confederation of Labor was equally eager to have Dr. Castro restored to the premiership. It called a general strike yesterday which all but turned Havana into a ghost city for one hour.

Confederation Chief David Salvador said that if Dr. Castro did not return to government by this Sunday, Cuban labor would begin a series of progressively longer strikes, beginning Monday, for two hours, Tuesday for three, and so on.

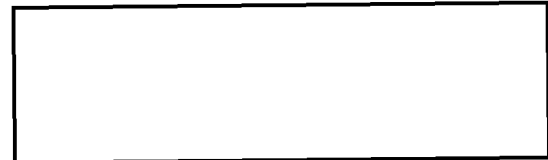

SEARCHED INDEXED
SERIALIZED FILED

JUL 24 1959

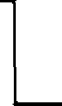

b3
b6
b7C
b7E

THE WASHINGTON DAILY NEWS, FRIDAY, JULY 24, 1959



Fidel Castro, attending the Textile Workers Congress at the Sports Palace in Havana, found a young friend, 6-year-old Doris Hernandez, to talk to. UPI Telephoto.

THE WASHINGTON DAILY NEWS, THURSDAY, JULY 23, 1959

Castro Return Is Certain

HAVANA, July 23 (UPI)—Fidel Castro said today he would let a mass rally of 500,000 Cubans decide Sunday whether he should return to active leadership of the Cuban government. It was clear they would keep him on the job with wild acclaim.

The rally, celebrating the sixth anniversary of the start of Dr. Castro's revolution, will be swelled by machete-wielding peasants who have been streaming into the capital by tens of thousands.

The bearded leader made his announcement in a one hour and 35-minute telecast that ended early this morning. It was his briefest telecast on record. They have run as long as four hours.

"So that our enemies will have nothing to say, so that our slanderers, detractors of the country know what they have to face, I am not going to resolve the question (of his

resignation as premier) today but I am going to resolve it on the 26th," Dr. Castro said.

Dr. Castro spoke from the Havana sports palace where textile workers were meeting. It was his first public appearance since last Friday and Saturday when he forced the resignation of Manuel Urrutia Lleo as president by resigning himself, and making a four-hour telecast in which he accused Sr. Urrutia of near treason.

A "private citizen," Dr. Gomez Quintero, filed treason charges against Sr. Urrutia yesterday in the Supreme Court demanding his arrest. There was no immediate indication what the disposition of the case would be.

President Osvaldo Dorticos Torrado, who took over from Sr. Urrutia, said he and the rest of the cabinet had kept heavy pressure on Dr. Castro to continue on as premier. Sr. Dorticos spoke in a separate telecast last night.

"The best thing which he can do now for the nation is to make the sacrifice of returning to be the head of the government," said Sr. Dorticos. "I hope the nation will succeed in making him withdraw it (resignation)."

Dr. Castro's subsequent declaration made it obvious that he could be persuaded.

His speech was sprinkled with ringing defenses of the past, present and future of the revolution. For Cubans, it was a stirring speech.

He said the course of the revolution would continue despite "jokes in the American Senate" or the forthcoming Foreign Ministers' Conference in Santiago, Chile.

SEARCHED _____ INDEXED _____
SERIALIZED _____ ED. _____
JUL 24 1959

b3
b6
b7C
b7E

Cubans Gather For Castro Rally

Thousands Stream Into Havana

By JOHN V. HORNER
Star Staff Writer

HAVANA, July 24.—Thousands of excited Cuban peasants, most of them carrying sharpened machetes, hold the spotlight in Havana today as they move restlessly toward a spectacular rally Sunday celebrating the sixth anniversary of Fidel Castro's 26th of July movement.

The campesinos or guajiros, as they are known, are streaming into the capital in ever-increasing numbers. They arrive hourly by train and bus, in wagons, on horseback and on foot.

They are determined to prove to the world that the Castro revolution is here to stay and that the bearded leader is Cuba's greatest modern hero.

For the most part the campesinos are good plain country people. They are unobtrusive and uncomplaining. They drink very little liquor and are loyal to the church.

Whipped Into Frenzy

They have been commanded to come here by the man they idolize and they are ready to do whatever they are told to do.

By public utterances, their leader has whipped them into a frenzy which worries a substantial element of Havana's substantial citizens. Furthermore the Castro government newspaper prints stories which seem designed primarily to incite the faithful from the country.

The newspaper exhorted the peasants to resist all requests of United States newsmen and photographers. As a result several Americans have been threatened and one farmer wielding a machete sliced the shirt off a National Broadcasting Co. cameraman and barely missed cutting the photographer in the chest.

All Activity Halts

Airators were busy yesterday during the one-hour work stoppage called by the Cuban labor union in a nation-wide appeal for Mr. Castro to accept reappointment as prime minister.

All business activity and traf-

See HAVANA, Page A-6

THE EVENING STAR

Page A1 Date 7/24/59
A6

HAVANA

(Continued From First Page)
He came to a stop at 10 o'clock. If you were in a taxicab or a bus, either you sat where you were or got out and walked. You couldn't buy a cup of coffee or ride an elevator.

One innocent young man riding a bicycle was told in no uncertain terms that no vehicles were supposed to move. The cyclist stopped riding.

Sometimes the tough tactics

backfired, however. When two Cuban photographers, one of whom works for the government newspaper *Revolucion*, continued to work during the strike, a peasant, following advice from *Revolucion*, attacked the *Revolucion* photographer. He was hospitalized.

Old Havana residents frown on the invasion of their country cousins for many reasons. The political situation is explosive and almost any incident could touch off a riot when the big crowd gathers Sunday.

There's also the problem of feeding and housing the Guajiros, Revolutionaries and civic groups are appealing to all citizens for help.

The peasants are being quartered in public buildings, in private homes and offices. They are being fed in army barracks and at the University of Havana. About 150 ragged visitors are sleeping in pink sheets on cots set up in the presidential palace.

Many residents take a dim view of the pressure put upon them to care for the country people. They also dislike being buttonholed on the streets for donations to help buy meals for the "poor boys from the country."

Reporters were assured by President Osvaldo Dorticos last night that the government is taking all necessary steps to prevent any acts of hostility against Americans during the celebrations.

"There is no hostility among the people or government of Cuba against the United States, nor can there be," he said after correspondents told him that some Americans had been threatened during yesterday's strike.

SEARCHED INDEXED
SERIALIZED FILED

JUL 27 1959

b3
b6
b7C
b7E

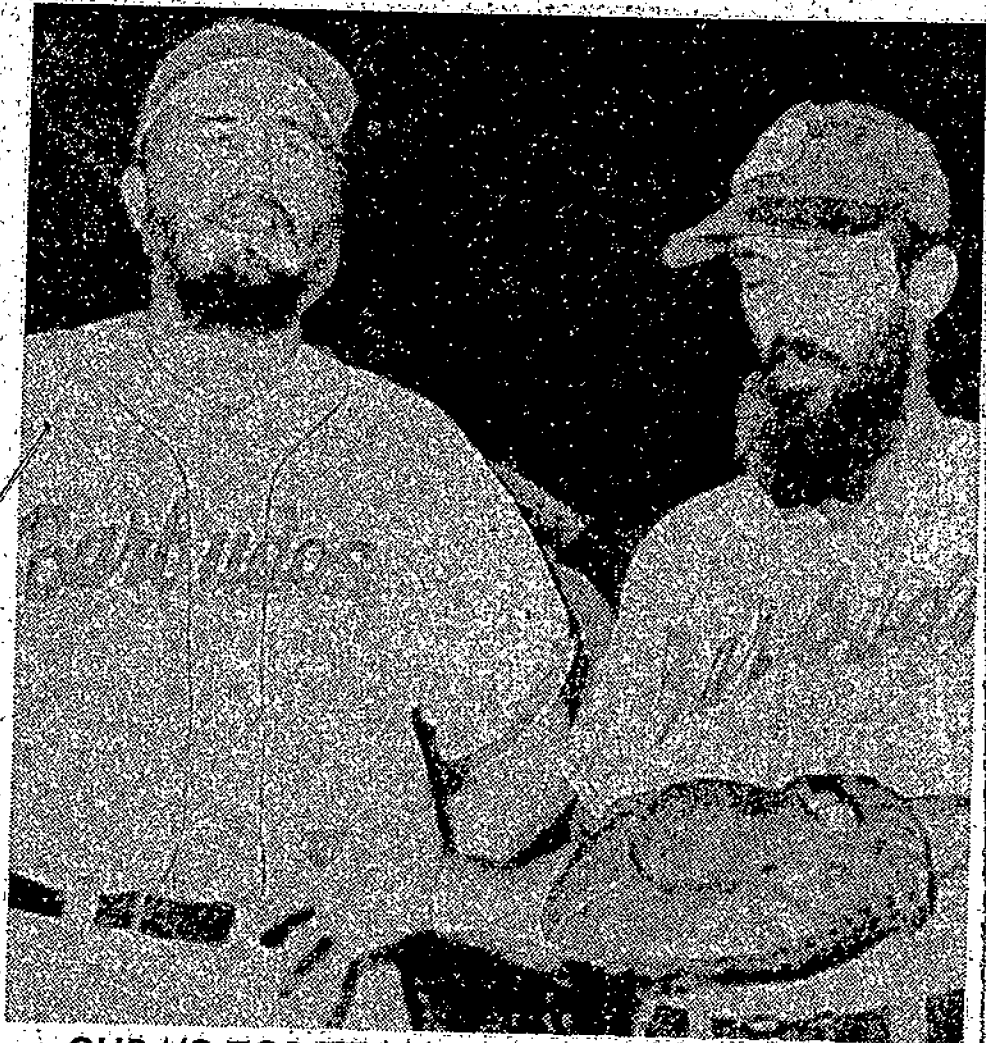

CUBA'S TOP TEAM—THE "BARBUDOS"

Cuban leader Fidel Castro (left) and his right-hand man, Commander Camilo Cienfuegos, army commander, were in uniform as pitcher and catcher respectively for the opening inning of a military-versus-police benefit baseball game last night in Havana. "Barbudos" on their shirts means "Bearded Ones," the mark of the Castro rebels. They celebrate the anniversary of their revolution movement tomorrow. — AP Wirephoto.

SEARCHED		INDEXED	
SERIALIZED		FILED	
JUL 25 1959			

b3
b6
b7C
b7E

Castro Resumes Post to Cheers Of Million in Havana, Jabs at U. S.

HAVANA, July 27 (AP)—Fidel Castro, swept back into the Cuban premiership as expected, by an enormous popular demonstration, served notice last night he will be friends with the United States if the United States doesn't get in his way.

The crowd estimated at nearly a million cheered wildly as he told them he would bow to "the will of the people" and resume office. The demonstration again underscored that the 32-year-old revolutionary leader is Cuba's new strong man.

The throng sent up reverberating cheers as Mr. Castro, by inference, told off critics in the United States.

"Red" Issue Sidestepped

He asserted that Cuba is not a protectorate or colony of any other country but a free sovereign nation and "we have to account to no one."

Mr. Castro said Cuba wants to be friends with all nations but can not be with those "who offend us, who insult us and who exploit us" nor with any vested interest which tries to "impose itself on the destiny of our people."

In two and one-half hours of talk, Mr. Castro failed to mention communism by name at all. He referred to it only obliquely, when hitting at his critics, but apparently did not feel it necessary to deny their charges that he is letting the Reds influence his government.

Uptown Havana's vast Civic Plaza was packed with the shouting, cheering throng. Mr. Castro told the crowd emotionally that from now on the "symbol of our revolution will be the machete," the long, sharp knife used for cutting sugar cane.

The announcement provoked furious response during which some 400,000 campesinos — farmers — brought from the provinces to swell the demonstration, clashed their machetes together in unison to add to the general uproar.

"Will of the People"

Mr. Castro whipped up another ovation when he added that if his enemies should ever think of coming back to Cuba, "let them contemplate for just about five minutes those machetes."

He made it clear that such mammoth demonstrations will be held whenever it is considered necessary to demonstrate popular support for his policies. Yesterday's, officially celebrating the anniversary of his 26th of July revolutionary movement, was called originally to demonstrate support for his land redistribution program.

Mr. Castro claimed it was

only the will of the people that persuaded him to resume the premiership he left nine days ago to force the resignation of Provisional President Manuel Urrutia.

The first announcement of his return to office came from President Osvaldo Dorticos, Mr. Urrutia's successor. It set off a wild, jubilant ovation, with the campesinos joyously throwing straw hats into the air. Mr. Castro had announced he would leave the decision to the people.

Showmanship Evident

Enormous showmanship went into making the rally. Games included the release of a thousand doves as Castro appeared, and release of hundreds

of red, white and blue balloons trailing the black and red colors of the 26th of July movement.

Planes and helicopters flew low overhead dropping small, multicolored parachutes containing candy.

Before the speech a cabinet minister presented Mr. Castro with evidence of recovery of \$20 million in cash and \$51 million worth of property from collaborators of Fulgencio Batista.

Half a dozen persons died here and elsewhere in the nation. A guard's rifle fire killed a convict during a prison riot in Havana. A farmer deemed crazed was shot by police. Three persons, including a policeman, were killed in Santiago.

The Rochester, (N.Y.) Red Wings of the International League refused to take the field for their scheduled Sunday contest with the Cuban Sugar Kings as a precaution against shooting.

Spent bullets which hit a player of each team broke up their Saturday game in 4-4 tie in the 11th inning. Neither man was hurt but the visitors chose not to risk it again.

There were reports that 17

persons had been injured in various parts of Havana. A number of Army officers were arrested for unauthorized firing of their guns to celebrate.

THE EVENING STAR
Page A3 Date 7-27-59

SEARCHED.....	INDEXED.....
SERIALIZED.....	FILED.....

JUL 29 1959

b3
b6
b7C
b7E

Castro Denies Unrest in Caribbean

HAVANA, July 27 (AP)—Fidel Castro declared today there are no tensions in the Caribbean. He suggested that American foreign ministers meeting Aug. 8 in Chile to discuss Caribbean tensions should consider instead hunger, poverty and underdevelopment in Latin America.

"They convoke it to deal with tensions because Trujillo asked for it," Castro told reporters at a news conference.

He referred to Generalissimo Rafael Trujillo, the Dominican Republic's strongman with whom he has been waging verbal war since the Cuban revolution overthrew dictator Fulgencio Batista.

Expeditionaries reportedly organized in Cuba have been creating nervousness in neighboring countries, particularly in the Dominican Republic, Haiti and Nicaragua.

OAS Gets Evidence

In Washington an Organization of American States fact-finding committee submitted evidence that one of Castro's close associates lent aid to last month's abortive invasion of Nicaragua, United Press International reported.

[At the same time, however, documents submitted by the four-nation investigating committee included a statement by one of the invaders, who said Castro's government opposed such ventures.

[Meanwhile, the Senate Foreign Relations Committee endorsed a proposal to increase efforts to prevent would-be rebels from using the soil of one nation to organize invasions of another.

[Castro, at his news conference, announced that he may attend the foreign ministers conference himself "if necessary."]

Returns to Office

Castro was speaking again as Cuba's Premier. The revolutionary leader accepted return to the office at a mass meeting here last night as the will of the people after nine days out of the government.

His remarks at the news con-

ference included: A fresh blast at Sen. James Eastland (D-Miss.) and Eastland's Senate Internal Security Subcommittee; another poke at what he called certain interests in the United States determined to defame Cuba's revolution; and a reiteration that Cuba has no dollars to pay for expropriated American lands and thus will have to cover the obligations with long-term bonds.

Castro met with the newsmen after a visit to the national police hospital where Rafael del Pino, an old revolutionary comrade, is held on charges of plotting against the Castro government. He was accompanied by National Police Chief Efigenio Ameigueras.

Castro apparently questioned del Pino in person for almost two hours.

Broke in 1956

Del Pino broke with Castro in 1956 after the bearded revolutionary accused him of tipping Mexican authorities to a Castro plan to send an expedition to Cuba. Castro said del Pino betrayed him for \$10,000.

On Saturday, police say, del Pino, 32, landed from Miami in a rented light plane. As he came down on a road outside Havana for a meeting with anti-Castro plotters, police in an ambush opened fire. Del Pino was wounded and burned.

A National Police spokesman said he will recover and will be charged as a counter-revolutionary under a new Cuban law and perhaps face a

firing squad. This raises a delicate question, since del Pino is an American citizen. He gained citizenship 12 years ago while serving in the United States Army.



SEARCHED INDEXED
SERIALIZED FILED
JUL 29 1959
FBI WASH F O

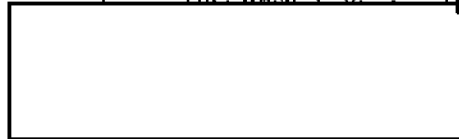

b3
b6
b7C
b7E

How Long Will Castro Hold Them Off?

Cuban Reds' Strength Overrated But U. S. Errors Could Aid Them

By William L. Ryan

HAVANA, Aug. 12 (AP)—Cuba's Communists have tried—and failed—to set up an ideal situation for themselves in present circumstances. Banking on unwitting help from the United States, they now await a fresh opportunity. To the Communists' delight, a basic misconception of what they are up to in Cuba tends to deflect United States attention from their immediate aims.

The Communists know—if many others do not—that they are not strong enough to turn Cuba into a Red satellite.

What they do seek is a free base for Red operations in the Caribbean and Latin America. Cuba would thus be an extremely valuable lever for creating turmoil all over the area.

Castro Holds Them Off

The Communists tipped their hands July 17 when Fidel Castro resigned as Premier in a maneuver to demonstrate his mass popularity.

Within two hours they broadcast an appeal for a "government of national unity," meaning they wanted cabinet representation. They would have settled for one or two ministries, but Castro held them off.

Participation in the government would nail down present Red advantages. The Communists have been highly successful, for example, in penetrating the army, whose high command has many dedicated

American-haters. One of the most dedicated is the commander-in-chief, Maj. Raul Castro, thin-lipped, Fidel's fanatical 30-year-old brother.

Communists also have penetrated the ranks of labor. They are organized, disciplined and dangerous.

A "national unity" government would help the Communists provoke angry and ill-considered responses from the United States—just what Latin American Reds need, typical examples of "Yankee imperialism" trying to dictate to weaker countries.

Few here would accuse Fidel Castro himself of being a Communist. Clashes involving North Americans tend to push the regime into standing somewhere between being not antagonistic and being downright sympathetic to the Communist bloc.

Kicking Rich Uncle

The Party plays expertly on inferiority complexes of weaker peoples to provoke the defiant attitude of the neglected child kicking its rich uncle in the shins. New revolutions need outside enemies, and "Yankee imperialism" fills the bill.

Castro has found himself pushed more and more into a defensive posture by criticism from the United States. Only recently has he seemed to sense the dangerous position into which the Cuban revolution is being maneuvered.

The following story is vouched for by a reliable source: Castro and his advisers were discussing Cuba's sugar crop and how to move it in the world market in the face of low prices and demand.

Somebody told him how the United States protects Cuba from price fluctuations by buying a sugar quota above the world market. The United States is buying about 3 million long tons of Cuba's current 5.8 million-ton crop above the world price. Castro seemed stunned.

"Why didn't somebody tell me about this before?" he shouted.

Hard Core Is Small

Inexperience in the regime helps strengthen the Communists though they are fewer now than in the early days of Fulgencio Batista's dictatorship.

Present card-carrying Communists probably total about 12,000. Of these, very few constitute a hard core, working for Moscow interests as transmitted by Juan Marinello, the Party president.

The Communists try to create and keep a climate basically hostile to the United States. We may succeed in helping them.

We need tact, patience and intelligent appraisal to keep a once hopeful-looking revolution from turning an indelible red.

WASHINGTON POST - TIMES HERALD

8/13/59, col. 1

SEARCHED [] INDEXED []
SERIALIZED [] FILED []

AUG 14 1959

b3
b6
b7C
b7E

C

Describes Double-Agent Strategy

Castro Brands Foreign Ministers Parley as Farce, Criticizes Herter

HAVANA, Aug. 14 (AP) — Shaking his fist in anger before a TV audience, Fidel Castro tonight called the American foreign ministers conference a "farce."

The conference at Santiago, Chile, is being held to deal with the Caribbean crisis.

The Cuban prime minister sharply criticized United States Secretary of State Christian A. Herter in a broadcast report to the nation on the counter-revolution plot against his revolutionary regime.

Castro said in recent weeks there had been four foreign shipments of arms to his enemies in Cuba—one from the

United States and three from the Dominican Republic. Castro hinted that all four had been intercepted.

Castro called Generalissimo Rafael L. Trujillo, the Dominican Republic strongman, "the financial boss of all those who are plotting against us."

But the Cuban Premier had some harsh words, too, for Secretary Herter and the United States. He said the United States Secretary, instead of talking about Latin America's economic problems and "about the hunger of babies in our countries, talks about expeditions that come and go.

Castro declared the Inter-

American Conference was not interested "in overthrowing the dictatorship of Trujillo but only in destroying the revolutionary government of Cuba.

"The Organization of American States is the victim of its own complicity with the dictatorships," he said. "The organization is a victim of its own errors."

Castro complained that Cuban "war criminals" refuged in the United States are permitted to do as they like, and said airplanes based in Miami have flown repeatedly to Cuba to drop anti-government leaflets or pick up war criminals.

See CUBA, A4, Col. 2

[Redacted]

SEARCHED	INDEXED
SERIALIZED	FILED
AUG 17 1959	

[Redacted]

[Redacted]

b3
b6
b7C
b7E

CUBA—From Page 1

Castro Brands Foreign Ministers Parley as Farce, Criticizes Herter

He accused Trujillo of being "the systematic enemy of Cuba," saying that the Dominican boss is an enemy "not only of the Castro Revolution but of the Cuban nation itself."

During the three months he (Castro) knew of the conspiracy against his government, Trujillo believed he had "bought and paid for" the loyalty of Maj. William Morgan and other veterans of the Second Front, Castro declared.

Castro, his beard untrimmed but his voice stronger and clearer than normal, opened his statement in the form of answers to questions of a TV panel.

The Cuban rebel leader di-

rected the opening period of his statement against Trujillo, whom he called "the only chief of the conspiracies against us." He did not mention immediately Cuban leaders, including former Dictator Fulgencio Batista, who are in exile in the Dominican Republic.

He told his audience that Maj. Morgan, formerly of Toledo, Ohio, now one of Castro's cloak and dagger men, had successfully convinced Trujillo that he was an adventurer who would do anything for money.

Castro confirmed that Morgan, at his instructions, had joined the conspirators and appeared to work with them

in their scheme to overthrow the Castro regime.

Castro declared that Maj. Morgan had so successfully misled the Dominican leader that Trujillo named him as head of the conspiracy, tossing aside the former Batista regime Gen. Eleuterio Pedraza. Pedraza had been regarded abroad as the leader of the anti-Castro forces under training in the Dominican Republic.

Castro also accused Trujillo of personally choosing a Cuban presidential candidate for the conspirators. The choice of Trujillo, Castro said, was Batista. Sen. Arturo Hernandez Tellabeche, now under arrest in Havana,

Claims Goods on Trujillo

Raul Castro Heads for Chile With 'Proof'

SANTIAGO, Chile, Aug. 17 (UPI) — Raul Castro and a band of Cuban revolutionaries were flying here today to "rescue" the Cuban foreign minister and to present proof that the Dominican Republic was trying to overthrow the Cuban government.

The Foreign minister, Raul Roa, was reported to have received death threats from the Dominicans while attending the meeting of the Western Hemisphere Foreign Ministers here. The Dominican Republic denied the charges.

Mr. Roa has accused the Dominicans of attempting to invade Cuba by sea and by air and informed sources said he would blame the Dominican Republic today for staging an invasion of Haiti and blaming it on the Fidel Castro movement.

Venezuela was moving to try to head off the expected fireworks with a resolution condemning dictatorships in the Western Hemisphere. Venezuelan Foreign Minister Luis Arcaya was especially anxious to indict Generalissimo Rafael Trujillo as a dictator and thus steal some of Raul Castro's thunder.

Reports persisted that Cuban Premier Fidel Castro also would come here, and a group of Cuban newspapermen said he might be traveling "incognito." But Raul told newsmen during a stopover at Caracas, Venezuela, Fidel would not come because he had no use for the Organization of American States which sponsored the present meeting.

Venezuela threw the anti-dictatorship resolution into the hopper just when a compromise resolution appeared to have been reached that would condemn aggression in general terms and set up a watchdog committee to study reported invasions—but only with the consent of the nations involved.

Today was to be the final working session of the for-

eight ministers conference with the windup scheduled for tomorrow, one day late. Whether Venezuela's efforts to indict Gen. Trujillo or whether Raul Castro's appearance would delay things remained to be seen.

He said he expected Peru, Cuba, El Salvador and Bolivia to support his emphatic statement that the hemisphere cannot condemn oppression elsewhere in the world as long as some American regimes disregard the basic democratic principles.

The Venezuelan resolution was one of at least eight prepared for working committees for discussion by the entire group. Others condemned aggression and asked for economic improvements to end the poverty blamed for much Caribbean unrest.

Raul, chief of Cuba's armed forces, was accompanied by a party of 42 Cubans, most of them revolutionaries but some of them newsmen.

Charge Castro Hoax

CIUDAD TRUJILLO, Dominican Republic, Aug. 17 — The Intelligence Chief of the Dominican Republic Army calls Fidel Castro's report of seizing an arms-laden plane coming from the Dominican Republic "one of the greatest swindles ever perpetrated on public opinion in the Americas."

Col. John Abbes Garcia yesterday said yesterday that it is "irrefutable" that revolts broke out in Cuba this month, but that Sr. Castro's story of the plane was a "farce to spread confusion."

WASHINGTON DAILY NEWS
Page 3 Date 8/17/59

SEARCHED		INDEXED	
SERIALIZED	FILED		
AUG 18 1959			

b3
b6
b7C
b7E

Warns New Peace Commission

Raul Castro Puts Damper on OAS

By HENRY RAYMONT

SANTIAGO, Chile, Aug. 19 (UPI)—A "hands off" warning by Raul Castro to the Organization of American States threatened today to cripple the new Inter-American Peace Commission before it even starts work.

The OAS foreign ministers conference was over only a few hours and the 21 ministers were in high spirits at their "Declaration of Santiago" when the Cuban military chief flew into this Chilean capital last night.

He indicated Cuba would refuse to admit the peace conference to investigate charges that Cuba had aided invaders of other Caribbean nations.

"The only police allowed in Cuba are the Cuban police," the pony-tailed young major said. "Cuba will resolve its own problems without the OAS."

Earlier in the day Cuban Foreign Minister Raul Rao had told the conference Cuba would co-operate in efforts to determine who was involved in a 30-man invasion of Haiti.

Maj. Castro, brother of Cuban Premier Fidel Castro, mixed his attack on the peace commission with unexpected praise for the overall results of the OAS meeting.

PRAISE

Both he and Fidel had denounced the meeting last week end and earlier this week but last night Raul said: "It seems something positive has been accomplished at the meeting."

"For the first time the conference discussed the evils of dictatorships, economic development and freedom of the press," he said.

Asked whether communists had a chance to gain a foothold in Cuba, Maj. Castro retorted: "Whoever puts a hand or foot in Cuba will have it cut off."



HERTER IS SHOWN—U. S. Ambassador to Chile, Walter Howe, (right) directs Secretary of State Christian Herter's attention to points of interest around the U. S. Embassy in Santiago, Chile, following the ending of the American Foreign Minister's conference.

—UPI Telephoto

Maj. Castro got a cool official reception from the Chilean government when he arrived and went thru customs just like any tourist. Three of the 30 men with him were held in custody for a period because they were carrying pistols.

Earlier, an advance party of Cuban soldiers arrived at the airport and were promptly ordered out of the country by Chilean authorities. Maj.

Castro admitted at his press conference later that the landing "was an error on our part" and Chilean authorities acted properly.

HERTER PLEASED

Secretary of State Christian A. Herter and the bulk of the foreign ministers were leaving for home today. Mr. Herter obviously was pleased with the conference, not only because of the opportunity to talk personally with the other American foreign ministers but because of the final conference papers.

"The Declaration of Santiago and accompanying documents are among the out-

standing papers in the history of inter-American co-operation," Mr. Herter said.

The declaration expressed support for free democratic institutions and condemned dictatorships but at the same time deplored foreign invasions and agreed that the OAS should develop some power to cope with them.

UNANIMOUS

Members of each of the 21 delegations said they sincerely felt the OAS had come out of its trial stronger than ever. Despite some bitter exchanges during the meeting, the final documents were approved unanimously.

In view of Raul Castro's rebuff to the peace commission, there was a big question as to whether the OAS could put its paper ideals into practical operation.

But experienced diplomats felt the moral effect of the conference would be so great as to force some liberalization in the remaining American dictatorships if not complete freedom.

b3
b6
b7C
b7E

INDEXED
FILED

AUG 19 1959
WASH. F. O.

21 Ministers Sign 'Final Act' To Close Santiago Conference

By Chalmers M. Roberts
Staff Reporter

SANTIAGO, Chile, Aug. 18 The Pan American Foreign Ministers' Conference ended today amid expressions all around on what a wonderful job had been done here.

Secretary of State Christian A. Herter, who leaves early Wednesday for Washington, declared that "the long-range effect of the conference will have great significance." Herter called the Santiago documents "among the most outstanding papers in the history of inter-American cooperation," and added that "the United States will do its part in translating them into action."

Chilean President Jorge Alessandri told a news conference he hoped the "results will be beneficial to the harmony of the continent and dispel any shadow of conflict in the future."

The conference concluded with the signing of all 21 Ministers of the "final act," which is a combination of all resolutions approved the previous day. Just what effect the conference will have, of course, is less clear than the high hopes generally expressed today.

In the United States view, the conference was a success for two reasons.

First, it avoided any but minor verbal spats between the two chief antagonists here, Cuba and the Dominican Republic. It did so by keeping away from direct charges and countercharges for the most part, thus avoiding the trap of having other Ministers sit in judgment on the two quarreling nations.

The effect on Cuba, whose volative leader, Fidel Castro, is hard to contain by words—even by the flood of words spoken here—remains to be seen.

The hope at least is that Cuba now realizes from the often rather chilly attitude here toward its freebooting expeditions aimed at overthrowing other governments that it is not a fair-haired boy



United Press International

Major Raul Castro, commander of the Cuban Army, and his wife, are shown having coffee at the Limatambo airport in Lima, Peru, en route to Santiago, Chile.

This family approach to problems was judged a second point of success, in the United States view. In a practical sense the hopes of the United States are now pinned on the revitalized Inter-American Peace Committee, which faces the difficult job of dampening Caribbean fires, beginning with the alleged invasion of Haiti by a Cuban group.

Herter today saw privately the last of his 20 fellow American Foreign Ministers. He has used the opportunity here to absorb something of the Latin temperament and problems, which admittedly have represented a new type of problem for him.

For example, he found a greater degree of feeling about the human rights problem than he had expected, but he

was a pleasing public word for Herter.

The Cubans were their own worst enemy during this conference. The on-again-off-again rumors of a Fidel Castro visit here, the abortive attempt to fly in a group of Cuban newsmen and officials in a military plane, and the comic-opera aspect of the visit by Castro's brother, Raul Castro.

All brought a certain amount of ridicule in words and cartoons in the Chilean press, which was also reflected in private comments of conference delegates. One notable failure was the effort of the Chilean Communist Party and fellow leftists to repudiate the conference and damn the United States for allegedly trying to make the meeting an anti-Castro rally. The Com-

report suggested that the Solers were linked with the invasion attempt, but gave no details.

AUG 19 1959
FBI WASH DC

b3
b6
b7C
b7E

b3
b6
b7C
b7E

agonists here, Dominican Republic charges and for the most ministers sit in two quarrel- Cuba, whose Fidel Castro, a by words— od of words, mains to be least is that es from the lly attitude freebooting ed at over- governments charged, by Castro over- orship eight at Cuba will reaction of ricans that it, the American in the same

States view. In a practical sense the hopes of the United States are now planned on the revitalized Inter-American Peace Committee, which faces the difficult job of dampening Caribbean fires, beginning with the alleged invasion of Haiti by a Cuban group. Heretofore today saw privately the last of his 20 fellow American Foreign Ministers. He has used the opportunity here to absorb something of the Latin temperament and problems, which admittedly have represented a new type of problem for him. For example, he found a greater degree of feeling about the human rights problem than he had expected, but he recognized that it's difficult to translate such aspirations into concrete form in an area of the world plagued by illiteracy and poverty. Incidentally, Alessandri told his press conference that Chile has no outstanding problems with the United States, which

Cubans Arrested, Expelled by Chile

SANTIAGO, Chile, Aug. 18 (AP)—Maj. Raul Castro, Cuban armed forces chief and brother of Fidel Castro, arrived here today by plane. Chilean authorities promptly arrested three gun-carrying Cuban soldiers in his party. Castro himself was not bothered.

Raul arrived here after the end of the American foreign ministers' conference. He described his trip as a good will visit and later said he was coming just to pick up the Cuban delegation and fly it home.

His advance party, including newsmen and armed soldiers, was taken into custody yesterday when it made an unauthorized landing in an armed transport plane. The group was expelled from Chile today.

Chilean law requires special permission for landings of planes with armed foreigners aboard. The advance party had no such permission.

Shortly after Castro's plane landed, Chilean officials went aboard and arrested three Cuban soldiers they said were carrying guns.

Some 300 persons at the airport greeted Castro with boos and cheers.

He and his wife, Vilma, entered a diplomatic automobile and were driven to a hotel.

Invaders Trapped In Haiti Mountains

PORT-AU-PRINCE, Haiti, Aug. 18 (AP)—Thirty armed invaders who landed in Haiti last week are trapped on a mountain near the coast, an authoritative source said today.

Haitian army units cornered the rebels on Caracasse Mountain behind the coastal town of Tiburon, the source said. Lack of food and water is expected to force them to surrender or try to fight their way out.

Meanwhile, it was reported that a British tanker was intercepted off Haiti's southwest coast by the Haitian Coast Guard. The tanker was reported stopped off Dame Marie, near where the invaders landed, and escorted to a Haitian port for inspection.

The vessel was en route from Venezuela to Santiago de Cuba with two million gallons of gasoline.

Cubans Linked In Banker's Death

CIUDAD TRUJILLO, Dominican Republic, Aug. 18 (UPI)—Juan A. Morales, manager of the reserve bank, was shot and killed today by two alleged swindlers identified by the government as agents of Fidel Castro's Cuban regime.

An official announcement identified the assailants as Policarpo Soler, a long-time refugee from Cuba, and his nephew, Agapito Soler.

Police said the shooting at the bank was connected with the "heft" of the airplane used in last week's abortive "invasion" of Cuba. The police

SEARCHED _____ INDEXED _____
SERIALIZED _____ FILED _____
AUG 19 1959
FBI WASH. F. O.

As I See It from Here

By Jesus Colon

TO COVER in a short column the last 10 years of the movement for peace and of the peace organizations in Latin America is impossible even in a summary form.



But from the study of the peace movements in Latin America a few general principles emerge.

One of these principles — the main one it seems to me — is that the struggle for peace today is intimately connected with the struggle for national independence of the colonial and dependent countries.

Another principle coming out of the struggles for peace is that the cold war, among its many well-known criminal uses, is an instrument by which imperialism prolongs the domination and exploitation of subjected countries.

Any blow given to American imperialism, like the Cuban revolution, is not only a great blow for the REAL and the COMPLETE liberation of the Hispanic nations, but also a great step forward for strengthening peace forces all over Latin America.

THE PEACE MOVEMENT is demonstrating the logic of the slogan first enunciated in 1848 in the Communist Manifesto: "Workers of the world, unite!"

We may add that not only the workers, but everybody, peoples of all nations, regardless of race, creed or color, should unite against the great danger of an H-bomb war, that can be touched up at any moment by the warmongers in Washington and Wall Street and the arms manufacturers who fear the emergence and development of a socialist world.

Military pacts with the U. S., involving military bases in Cuba, Puerto Rico, Panama, etc., by the Latin American yes-men for American imperialism have tied most governments south of the Rio Grande to the cold war.

Latin American countries have been forced to assign 30 percent of their budgets to outdated, useless armaments that are mostly bought in the U. S.

This cold war has further restricted many Latin American countries to a monocultural production tied to the unilateral U. S. market, which has the last say as to quotas, prices and export and import conditions in general.

IN CHILE, for example, the working class has been fighting for unity and international understanding with the workers of the world for peace.

The Chilean Workers Socialist Party that preceded the present Communist Party of Chile condemned the imperialist war of 1914.

The Chilean working class, as far back as 1905 and through "La Vox del Pueblo" (The Voice of the People), published in Valparaiso at the time, appealed to its readers to raise money to help the Russian 1905 revolutionaries.

Peace Week was celebrated April 20-26 in Chile.

On April 26, a peace meeting was held at the Princesa Theatre in Santiago de Chile. Olga Poblete, university professor and peace leader, was one of the speakers. Other speakers were colonel Alfredo de Arnesti, (retired), president of the Partisans for Peace of Chile and ex-congressman and government minister Sergio Recabarren. Among those in this great peace meeting was Chilean senator Humberto Martones.

Peace actions were organized in many other cities of Chile.

WE CANNOT TALK about the peace movement in Latin America without mentioning Maria Rosa Oliver, writer and peace leader of Argentina.

Because of her work for peace and for understanding among the people of all nations, and in recognition of the work done by all the Argentinian partisans for peace, the World Council for Peace conferred on Rosa Maria Oliver the International Lenin Peace prize.

Boris Polevoi, Soviet writer, travelled to Argentina and presented the prize to her June 9 last year in Buenos Aires. Argentine leaders in letters, science and arts, and union and progressive leaders, as well as many prominent figures in Latin America and Europe, were present at these ceremonies.

THE WORLD COUNCIL for Peace, meeting in Stockholm May 8-13 this year, unanimously approved the recommendation of its International Prize Committee to confer the commemorative 10th Anniversary Gold Medal and a diploma to the Peace Council of Puerto Rico.

In the letter written by Jorge Zalamea, secretary of the Prize Committee, the following recognition of the work done by the Puerto Rican partisans for peace appeared:

"Your struggle under difficult circumstances has been an effective and generous contribution to our movement. You have always known how to answer to our calls; participate in our campaigns, take important initiatives, properly linking your activities in behalf of world peace with your struggles for national independence."

THE WORKER
August 2, 1959
Page 10 Column 1-2

INDEXED
SERIALIZED FILED
AUG 20 1959
FBI - WASHINGTON

b3
b6
b7C
b7E

As I See It from Here

By Jesus Colon

ACCORDING to the best Cuban sources of information, Pedro Luis Diaz Lanz, ex-major, did not resign his post. He was removed as Chief of the Cuban Air Force not because of ideological differences, but because of nepotism, maladministration of funds, mismanagement, keeping ex-Batista pilots and other air personnel in position of confidence and danger to the security of the nation, and the general state of anarchy with which he ran the Air Force department.



After he was removed, he made a rush almost by force, to recapture his command, disregarding the appointment already made of Captain Juan Almeida. In his rush he was accompanied by U.S. newspapermen and photographers, in the hope that he could provoke a scene that might be blamed on "communist domination" — an incident that might be picked up by the international press service, always eager to hook up anything that might give a wrong picture of what is happening in Cuba.

Diaz Lanz knew that the government was looking for him to present a long list of charges against him, so he deserted and became an informer against the Cuban people. The investigation in Cuba, however, is continuing.

THIS IS HOW Diaz Lanz came to the U. S., the refuge of the ex-dictators, to become the darling of Senator Eastland in the Senate Internal Security Subcommittee and give "secret reports" in the hope of helping the American imperialist interests against Cuba. He tried to lay the conditions for an anti-communist Guatemala-like "liberation" of Culla, perhaps with an Urrutia in the role of a Cuban Castillo Armas.

We learn from sources in the air force of Cuba that Diaz Lanz kept 20 pilots, who previously fought for Batista, in charge of their airforce

planes, notwithstanding the danger to the nation repeatedly pointed out to him.

He gave pilots' licences and airforce grades to his proteges and to the members of the clique with which he surrounded himself, ignoring revolutionary pilots who fought all the way from Sierra Maestra to Havana. He relegated these proven revolutionaries in the air force to cleaning jobs in the airfields, disregarding the high military grades that these revolutionaries had won in the field of battle.

He placed his father at the head of the cadet school in Baracoa. He made his brother Marcos commander of the Air Force, and another brother, Eduardo, adjutant of the Air Force.

★
ANOTHER CHARGE against Diaz Lanz is that he let the airforce equipment deteriorate, caring very little about its upkeep.

He was also charged with lack of revolutionary vigilance. He minimized the importance of the flights of Trujillo's planes over Cuba.

His exhibitionism made him purchase dozens of uniforms made to order from the most expensive materials. Stars were embroidered in these uniforms, recalling the opera bouffe uniforms of dictator Perez Jimenez.

During the trials of the Batista pilots accused of bombing Cuban towns, Diaz Lanz offered aid and comfort to the accused, and acting through persons belonging to his clique, like Ernesto de la Fe, FBI informer, he tried to establish relations with counter-revolutionary forces in Cuba and reduce the penalties of the pilots who were found guilty.

★
THE U. S. SENATE Internal Security subcommittee in giving a world platform to a deserter and traitor like Diaz Lanz, has proven something that we have known for a long time — that such subcommittees and committees in Washington are the stooges of the American imperialist interests for whatever "job" is to be done anywhere in the world in the name of "saving the world from communism".

THE WORKER
August 9, 1959
Page 10 Column 1-2-3

SEARCHED INDEXED
SERIALIZED FILED
AUG 20 1959

b3
b6
b7C
b7E

Castro Tells Our Reporter Of Fight against Bias

By T. R. BASSETT

HAVANA. — At a press conference here, I asked Premier Fidel Castro about his government's attitude to racial discrimination. I told him that I represented a U. S. newspaper which is sympathetic to the Cuban revolution + The Worker.

Then I asked: "What has the Cuban revolution done to put an end to racial discrimination in Cuba?" Nineteen million Negro people in the U.S., particularly, would like to know, I explained.

"The revolution," replied Dr. Castro, "has accomplished a great deal, above all, because discrimination is based on prejudice springing from long standing social and economic causes.

"The struggle against prejudice is one of the most difficult any government can face. Nevertheless, the Cuban revolution is bringing about changes in the thinking of the people on every front, and on the front of racial prejudice big changes have clearly taken place among our people."

★

THEN, EXPLAINING the concrete approach to achieving integration under Cuban conditions, Castro said:

"Racial prejudice is more and more disappearing. An example can be seen in what has happened in our recreational centers where the beaches as a rule were fenced in and access allowed to only a limited number of persons.

"We have opened up these beaches and we have established first-class recreational centers there.

"Everybody, regardless of class or race, is using these beaches."

★

IT IS BY "these persuasive procedures and intelligent means," he continued, "that we are arriving at a process of abolition of racial prejudice. And we believe that pursuing this course we will go a long way.

"In fact there is no better occasion than this, in which all the people have shown such a spirit of understanding in behalf of integration, to do battle against racial prejudice and discrimination with our methods."

★

THE national revolutionary government headed by Castro has tackled racial discrimination, political, economic, and social, in a serious way. This policy was set forth by Castro in what is known here as the "Proclamation" during the great farmer-labor-people's demonstration on July 29.

Middle class, white families in the Vedado suburb of Havana took Negro farmers and farm workers into their homes along with the white. Negro and white "guajirios" were also welcomed in the big tourist hotels previously practicing a discriminatory policy.

Other examples:

Negroes are now integrated in the Officers' Club, Juan Almeida, chief of the air force is Negro. Calixto Garcia, military chief of Oriente province, is Negro.

DISCRIMINATION in housing is against the law. If you are refused an apartment because of color, religion or national origin, file a complaint with the Commission on Intergroup Relations. For your convenience, a representative of the Commission will be at the Urban League office, 204 West 135th Street, every Tuesday evening from 6 to 8 p.m.

and their neighbors on a community basis. And it was the independent political activity of the rank and file, finally unleashed, that defeated Big Business' phony

MRFK
451 7 1759
6.3 column 4-5

b3
b7E

Cuban Youth and Peasants Unite for July 26 Anniversary

By STELLA JUAREZ

HAVANA, Cuba — This city, which usually houses 1,250,000 people, will be the home of another half-million on July 26.

A half-million peasants are coming to the capital on the anniversary of the July 26 assault on Batista's army post "Moncada."

The Cuban youth, as a whole, through the different student, worker, political and religious organizations (as well as individually) are out to help make this the most successful and expressive demonstration ever seen in this country, and probably in all of Latin America.

Peasants will arrive not only to celebrate or commemorate this anniversary as much as to stand as one man behind the revolutionary government, and all the revolutionary laws it has created.

Even more than this, these men will be here as living proof to all counter-revolutionaries that Cuba has outgrown the stage where it could be passed from one hand to another as some sort of lottery prize, and is way past the stage where economic outside pressures could scare the govern-



ticular. These are the farmers, the forgotten ones, the hungry, parasite-ridden, ill-clad and

young workers, asking the government to organize them into

working conditions. If they do not get these provisions for sensible, Steel is trying to take away from the company Great Lakes. The company Great Lakes is talking to newsmen. out 54 days, a member of the local 1999 strike committee in the were in 1962 when we were conditions are worse today than the steel workers out here.

An open health worker at Bethlehem Steel is trying to take away from the company Great Lakes. The company Great Lakes is talking to newsmen. out 54 days, a member of the local 1999 strike committee in the were in 1962 when we were conditions are worse today than the steel workers out here.

from them. companies take their rights away determined not to let the steel he told the press. "Those men are - Of the mood of the workers, steel worker in the United States." chairman as the highest paid. Typical of some of the com- is fighting for. to the demand the international there is still much confusion as of work and the steelworkers. reporter had with a large number

THE WORKER
July 26, 1959
Page 6 Column 1-2-3

SEARCHED	INDEXED
SERIALIZED	FILED
AUG 20 1959	

b3
b6
b7C
b7E

As I See It from Here

By Jesus Colon

ACCORDING to the North American press — page one in the New York Times — Major Pedro Luis Diaz Lanz, former chief of the Cuban Air Force, "resigned" because, according to him, the Cuban armed forces, the Cuban government, Raul Castro and Dr. Fidel Castro himself are communists and Cuba is just another province of Russia which is five thousand miles away.



See fellows? We were wrong. We thought until now that Cuba was a private province of the American Sugar Trust, of the owners of the Kings Ranch, of the National City and Chase Manhattan banks and the rest of the giant utilities and financial interests of American imperialism in Cuba.

I also thought that a man — a great Cuban leader — named Fidel Castro, his July 26 Movement and the whole Cuban people backing them, were striving to snatch Cuba from Wall Street and give it back — through the Agrarian reform and other measures — to the Cuban people, the original owners.

Now comes this Major Pedro Luis Diaz Lanz, (what a long and pompous sounding aristocratic name!), and, as an ex-major, no less, of the Cuban army, to tell us and the whole people of the United States, that all this is not so. That all these measures taken by the Cuban revolutionary government — measures that according to well conducted public opinion polls are being backed by more than 95 percent of the Cuban people — all these are just communism, and the Russians are at the very shores of Florida, instead of in Madison Square Garden and the New York Coliseum.

Pedro Luis Diaz Lanz's public statement was

accompanied with all the cheap dramatism of the McCarthy era. The solemn announcement of the telephone call asserting that the life of the informer was in danger. The bomb scare. The clearing of the hall followed by experts from the bombing squad making a thorough inspection looking for the non-existing bomb. And all the other sensationalist props used by the late Senator from Wisconsin during his ill-famed hysterical period in the nation's limelight.

Senator James O. Eastland, that great lover of equality and democracy from the equality loving state of Mississippi, Eastland, whose battles for the Negro, the Mexican American and the Puerto Rican in the U.S. are sung in prose and verse far and wide throughout the length and breadth of this country, in Asia, Africa and Latin America. Eastland, that great exponent of "American fair play" and the "American way of life" especially when Negroes are involved, was presiding with a straight face all throughout Pedro Luis Diaz Lanz's outpourings in Washington.

Well, I suppose that the next step to be made by Pedro Luis Diaz Lanz is to go on a nationwide TV hookup, write a series of syndicated articles on "Communist Cuba" and top it all off with a book entitled "I Led Four Lives" — one for every part of his high sounding name.

The book, of course, will be converted into a very intriguing Hollywood film, exposing communism in Cuba, Puerto Rico, the Virgin Islands and in the peaks of the Andes.

All this will be done by Pedro Luis Diaz Lanz in the U. S. where those exemplary apostles of democracy, Perez Jimenez, Masferrer, Magliore and many others, are now living, and where Batista, Peron, Trujillo, Somoza and company will eventually make their final abode if the grateful citizens of their respective countries will not compensate them in an appropriate manner before they leave.

Next week: Who is Pedro Luis Diaz Lanz?

THE WORKER

July 26, 1959

Page 10 Column 1-2

SEARCHED INDEXED
SERIALIZED FILED
AUG 20 1959
FBI - WASHINGTON

b3
b6
b7C
b7E

Castro Backer Target of Guns

HAVANA, Aug. 19 (AP). — Gunmen attacked a guard post outside the home of Maj. Eloy Gutierrez Menoyo yesterday in the first reported violence against supporters of Fidel Castro who infiltrated the conspiracy against this government.

Occupants of a speeding automobile sprayed the building in which the Cuban officer lives, but there were no casualties.

Maj. Gutierrez Menoyo headed a group of 26 Castro men in cloak and dagger work which starred Maj. William Morgan of Toledo, Ohio.

Reports from Camaguey, in East Cuba, said military investigators seized a cache of arms apparently hoarded by counter-revolutionaries.

Military intelligence headquarters at Santa Clara, in Central Cuba, detained a private plane with four Americans on the way from Key West, Fla., to Jamaica.

Officials in Santa Clara said the plane, which had taken off from Havana, lacked the special flight permit now required of all private planes operating over Cuban territory.

The Americans were permitted to wait at a Santa Clara hotel pending clarification of their status. They were not identified immediately.

SEARCHED		INDEXED	
SERIALIZED		FILED.....	
AUG 21 1959			

b3
b6
b7C
b7E

2

Soviet Agent Led Reds In Cuba, CIA Man Says

MINNEAPOLIS, Aug. 24 (AP).—A United States intelligence spokesman reported today that Moscow sent a Soviet intelligence officer to Cuba last May to guide local Communists on how to penetrate the government of Fidel Castro.

He also said the Soviets are secretly training more and more Latin American Communists in Russia on how to set up Communist dictatorships at home.

This word was given out by Gen. C. P. Cabell, deputy director of the Central Intelligence Agency, in a speech prepared for a meeting of the American Legion's National Security Commission.

Cites Subversion Pattern

Gen. Cabell declared that Kremlin tactics have turned full circle from missile rattling to smiling faces, but their goal remains Communist rule of the world.

He did not mention in his prepared remarks the forthcoming visit to the United States by Soviet Premier Nikita S. Khrushchev, nor the just concluded Santiago foreign ministers meeting aimed at combatting unrest in the Caribbean.

But he did cite Latin America as an example in what he pictured as a worldwide pattern of Communist subversion.

He named the Soviet intelligence officer as Vadim Kotcherin. He said Mr. Kotcherin was sent to Cuba under a false name, ostensibly as a member of a Russian trade union delegation and has since returned to Moscow.

While in Cuba, Gen. Cabell said, Mr. Kotcherin's assignment was to give guidance to Cuban Communists.

"The Communist Party of Cuba, called the Popular Socialist Party, has been given (Soviet) guidance on how to penetrate and exploit the government of Fidel Castro," Gen. Cabell added.

"Primary targets for Com-

munist penetration in Cuba are the agrarian reforms, trade unions and the army.

He said Red Chinese propagandists also are setting up a newspaper in Cuba.

Although Mr. Castro's opponents have charged his regime is Communist dominated, the revolution leader denies he is a Communist.

As for instruction of Latin American Communists in Russia, Gen. Cabell said the students are taught "techniques of gaining state power, leading to the establishment of Communist dictatorships."

Activities Expensive

The American intelligence official said Moscow's region-wide activities in Latin America include guidance to Latin Reds in preparing a "Congress of Latin American Peoples." The Moscow directive, he said, "calls for complete concealment of the Communist instigation and initiation of the congress."

Other Red operations Gen. Cabell listed included Soviet aid channeled to the Confederation of Workers of Latin America through the World Federation of Trade Unions, union contacts with the Russian Embassy in Mexico and Communist Chinese propaganda spread through Spanish language radio programs and cultural societies.



SEARCHED INDEXED
SERIALIZED FILED

AUG 24 1959

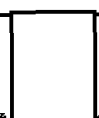

b3
b6
b7C
b7E

Culled From Such as Hitler, Mussolini, Others

Castro Revolution Called Jumble of Borrowed Ideas

By E. TOMLINSON

Written for Scripps-Howard Newspapers

Fidel Castro's "liberating revolution" for Cuba begins to look like a jumble of ideas and schemes borrowed from a dozen or more of the discredited dictatorships and regimes of our time.

At least very few of its tenets and methods can be called original or "liberating." The majority, especially those bearing on military power and politics, are right out of the lexicons of Hitler, Mussolini, Peron and even hated Trujillo and Batista.

First off, Castro set up his own military machine. He not only sacked all the officers but discharged most of the rank and file of the old armed forces and replaced them with mountain peasants, farm laborers, and soldiers of fortune, native and foreign.

This also is what happened in Bolivia following the revolution led by leftist Victor Paz Estenssoro. Hitler had his brown-shirted "storm troopers" and Mussolini his black shirts.

Similarly Castro has adopted beards, jungle green shirts and fatigue pants to distinguish himself and his revolutionary disciples.

The new boss of Cuba has borrowed a leaf from other strong men by setting up a program of regimentation for the children of the country. His youth police patrols, already more than 25,000 strong, are made up of children seven to 14 years old.

The patrols are designed not only to "teach discipline" and spread the "ideals of the revolution among the other youth of the land," but to help police the cities and towns and "report to the authorities on what happens in their various neighborhoods."

CLASSES

Personnel of the new "Peoples Army" are reported attending "indoctrination classes" so that they may understand and be able to teach the general population, as well as enforce the rules of the new social and economic system in Cuba.

Castro has adopted an even more cynical attitude toward electoral processes than any of the other recent strong men of the hemisphere. Perez Jimenez of Venezuela, Rojas Pinilla of Colombia, Peron of Argentina and Trujillo of the Dominican Republic have made a practice of holding some kind of elections periodically, even if the ballots were counted to suit those in power.

Castro merely calls the populace from the rural districts, principally, into the city and village plazas, and asks for a raise of hands.

Other Latin American developments:

Mexico

TIJUANA, Mexico, Aug. 24 (UPI) — Authorities pressed

their search today for a carload of men who ambushed three officers including the La Mesa state prison administrator near downtown Tijuana.

Authorities here said they believed there were six men in the car that opened fire on administrator Jesus Mayoral Arce, 30, his brother and a policeman late Friday night.

No explanation was offered for the attack.

Sr. Arce, the most seriously injured, was reported in critical condition at Miguel Aleman Civil Hospital where he underwent a five-hour surgery.

Havana

HAVANA, Aug. 24 — The continuing arrests of persons accused of participating in a counter-revolutionary plot against Premier Fidel Castro netted five more suspects yesterday. Some 184 suspected plotters are in the military fortress in Havana awaiting trial.

Fidel Jr.

CHICAGO, Aug. 24 (UPI) — Fidel Castro Jr., 10, son of the Cuban premier, arrived last night to attend the Pan American games which open Thursday.

Young Castro was met at Midway airport by 20 Chicago policemen and detectives. U. S. Security agents accompanied him on the trip here. The arrival was a closely guarded secret to prevent possible harm to the boy from supporters of former Cuban dictator Fulgencio Batista.

WASHINGTON DAILY NEWS

Page 7 Date 8/24/59

SEARCHED.....INDEXED.....
SERIALIZED.....
AUG 24 1959

b3
b6
b7C
b7E

A 4 Thursday, August 20, 1959 THE WASHINGTON POST

Communism Will Be Outlawed In Argentina, Frondizi Says

BUENOS AIRES, Aug. 19.

(UPI)—President Arturo Frondizi plans to outlaw communism in Argentina, it was announced today.

The official press service said Frondizi outlined his domestic program in a 90-minute speech before 300 top-ranking military officers at a briefing in Argentina's "White House" last night.

Frondizi reportedly said he planned to outlaw communism because he had proof of its "subversive intention to create general ill-feeling." He also said the Peronist Party, either under its own name or its new "Social Justice" label, will be barred from putting up candidates in the March voting.

Frondizi said electoral laws would be revised to provide proportional representation in the March election and assure minority parties of representation.

He reaffirmed his determination to stick to Argentina's present "austerity" program, resisting union pressures for blanket wage increases.

Pro-Cuban demonstrators last night tar-bombed the U. S. Embassy, leaving a stain on the wall of the building. Police dispersed the group, which had been cheering Cuba and Premier Fidel Castro.

Cuban Police Arrest Aide of Ex-President

HAVANA, Aug. 19 (AP)—Police blockades today netted a retired Cuban general and a carload of persons accused of terrorist shootings after another night of gunfire in Havana.

Police said they arrested Gen. Enrique Hernandez Nardo, national police supervisor under President Ramon Grau San Martin, as he attempted to cross a barrier of patrol cars investigating reports of a low flying light plane.

Gunmen fired at police and electric installations in downtown Havana.

Tampa gambler Santos Trafficante was released officially today after Cuban officials reported they could find no proof of any "serious charges against him here or abroad."

Also released was Henry Saavedra, 29, of Tampa. Both were arrested in an early June roundup of "undesirables," but appealed deportation orders. Both may continue, residing in Cuba if they desire.

Both men claimed they had no connections with any illegal activities but were only interested in gambling, which is legal in Cuba.

Trafficante was arrested June 8 after Harry Anslinger, U. S. Commissioner of Narcotics, told Cuban authorities he was a top narcotics suspect in the United States.

Latin Red Leaders Meeting in Chile

Chicago Tribune Press Service

SANTIAGO, Chile, Aug. 19. A meeting of the Latin American Cominform is in progress here. Communist leaders from most Latin American countries arrived mostly under the guise of newspapermen, ostensibly to cover the Foreign Ministers' Conference which ended yesterday.

A press conference for Maj. Raul Castro, Commander of the armed forces of Cuba, was stacked with Communist newspapermen who applauded Castro's anti-American statements. Castro will start for Havana Thursday.

SEARCHED.....INDEXED.....
SERIALIZED.....FILED.....

AUG 21 1959

b3
b6
b7
b7



YUGOSLAV WELCOME

Yugoslav President Tito gives a glad hand to a bearded Cuban emissary, Maj. Ernesto Guevara, at his summer home on Brioni Island last week. Maj. Guevara is head of a Cuban goodwill delegation which includes Omar Narciso Fernandez Camizares (center), a top Castro aide.—AP Wirephoto.

[Redacted]

b3
b6
b7C
b7E

SEARCHED.....	INDEXED.....
SERIALIZED.....	FILED.....
AUG 28 1959	
[Redacted]	

1
24

TURMOIL IN THE CARIBBEAN

Cuban Experts See Castro Upset Likely

BY JOHN V. HORNER
Star Staff Writer

The anti-American dictatorship established by Fidel Castro to satisfy his personal whims is almost certainly headed for destruction.

That is the consensus of many responsible observers in and outside of Cuba who are flabbergasted by brazen doings of the inexperienced young revolutionary premier.

A large number of those interviewed on the subject—men and women in politics, the professions and business—are convinced it is merely a question of how long Mr. Castro can last.

Some predict the demise of his government within six months. Others give him a year; some, two years or more.

People in Havana are even speculating—in strictest privacy, to be sure—on how the Castro era will end. You can get bets, if you try, that he'll be overthrown in a coup d'etat, or that he will be the victim of an assassin, a possibility he suggested in public.

Batista Support Remains

It is surprising, in view of the extensive spy networks maintained by the revolutionaries, that so much discussion takes place on these subjects, even privately. It can be taken as an indication of the growing disenchantment with Fidel Castro.

There still remains a sizeable group of citizens loyal to former President Fulgencio Ba-

This is the second of six articles by Mr. Horner based on an intensive personal survey of the Caribbean trouble spots. Other articles will deal with the Dominican Republic, Haiti and Venezuela. The sixth will sum up Mr. Horner's impressions.

tista, the personable but money-mad dictator toppled by Castro revolutionaries January 1. But the vast majority of Cubans tired of Gen. Batista and were glad to see him kicked out.

In the flush of a spectacular victory against unbelievable odds, Mr. Castro proved not only a hero to the young people and the peasants who supported him, but to many from the middle classes and some from the highest level of society.

Substantial citizens who had not helped him with the campaign against Gen. Batista found him acceptable on the basis of his democratic pronouncements. They offered to help him.

Wealthy citizens quietly See CARIBBEAN, Page A-7

SEARCHED	INDEXED
SERIALIZED	FILED
AUG 25 1959	

b3
b6
b7C
b7E

CARIBBEAN

Continued From First Page

soured on Mr. Castro as his land reform and general economic program unfolded. As Prime Minister he slashed rents by 30 to 50 per cent, a move which pleased tenants but naturally displeased property owners.

Law Lacks Details

Owners of vacant lots were ordered to sell to anyone wishing to build a home. Then Mr. Castro maddened investors by declaring land prices were excessive.

In May the Prime Minister alienated many of the larger landowners and businessmen when he announced the agrarian reform law, the cornerstone of his social revolution.

This law, which has not yet been implemented by the all-important regulations spelling out details, hits the great Cuban sugar industry particularly hard. It causes major concern also among cattle men, coffee growers, tobacco growers and other interests.

In all probability, the government will stand or fall on the success of its land reform policy. Unless it succeeds, Mr. Castro faces the prospect of losing support among not only the upper classes but the campesinos (farmers) too.

The law, in effect, ends non-Cuban ownership of sugar cane producing property and prohibits foreigners from owning agricultural land in the future.

Offered Bonds in Payment

Almost 10 million acres of land is subject to expropriation. For this the government has proposed paying off the owners with 20-year peso bonds bearing not more than 4 1/2 per cent interest. Those involved have called this plan unacceptable.

The government decided also it would pay not on the basis of actual values but on the basis of tax valuation.

Theoretically, peasant families selected by the government will each get 67 acres of the expropriated land. Under terms of the Marxist-tinged law, the government decides what crop is to be grown on each tract, how much, where the crop is sold and for what price.

The peasant cannot mortgage the land and cannot sell it. Only under certain conditions can it be passed to the oldest son of the family.

International Law Cited

Cubans as well as Americans have protested the land reform policy. The United States formally expressed concern over the compensation proposed.

The State Department

protest, recognized Cuba's right to expropriate foreign-owned property in the absence of treaty provisions to the contrary. But it firmly reminded Cuba this right, under international law, is "coupled with the corresponding obligation that such taking will be accompanied by payments of prompt, adequate and effective compensation."

The United States pointedly expressed regret that the Castro government did not give a hearing to American investors who would be affected adversely.

The attitude of the revolutionary regime toward American interests is a source of constant irritation.

With the apparent exception of Mr. Castro, everyone knows that Cuban economy is inevitably linked with the United States. The United States is Cuba's largest supplier and also its biggest customer.

Spokesmen for the sugar industry protest that their companies cannot comply with provisions of the agrarian law and their mills cannot operate efficiently under some of the present terms. Thus an eventual shutdown may be expected.

What then? If shutdowns occur on a large scale, economic chaos would follow, for no man could expect the Cuban workers operating independently and utterly lacking in know-how, to do what is impossible.

And, some 500,000 jobs depend upon the sugar industry at the employment peak.

Unemployment is one of the big problems plaguing Prime Minister Castro. He says 700,000 Cubans are idle now. Reliable American sources estimate the number at 450,000 and say the other 250,000 are "under-employed" in part-time jobs. The total working force is 2 1/2 million.

How all these people can be put back to work and how the land reform program or other revolutionary projects are going to be financed remain unclear.

The government did pick up some \$120 million in "conscience" tax return money within the first six months of 1959. Also, it confiscated about \$20 million found in safe deposit boxes held by Batista followers who fled. And about as much more has been contributed by individuals to the land reform movement. But all of this won't begin to buy what Fidel Castro promised his people when he marched them into Cuba's new promised Land.

He guaranteed, among many other things, full time employment and higher wages for

pay boosts for sugar workers if that industry is disrupted economically is just one question that stumps practical economists.

Looking beyond that, Prime Minister Castro may well begin to wonder how long the disillusioned, jobless and hungry farmers will continue to raise their sugar-cane machetes and chant: "Fidel! Fidel! Fidel!"

Small wonder the Communists—now befriended by Mr. Castro—are biding their time. They can afford to wait for the next big internal crisis before making their outright bid for power.

It is being said in Cuba that the machete, the symbol of Fidel Castro's revolution, looks to the Communists like a straightened-out sickle.

Tomorrow: The Dominican Republic, embattled target of Caribbean "liberators."

THE EVENING STAR
Page A2 Date 8/24/59

SEARCHED.....	INDEXED.....
SERIALIZED.....	FILED.....
AUG 25 1959	
FBI - WASH. F. O.	

Leftism in Cuba A 10

In a letter published on Aug. 18, George Hallgarten states that those who would brandish Sr. Castro as a Communist are not even vaguely familiar with his land reform scheme. I would never dream of brandishing the bearded one, as he is far too heavy, nevertheless, although my understanding of his agrarian plan may be vague, my understanding of communism is quite clear, and I daresay that few capitalists in the area have read more Red literature than have I.

The question as to whether Fidel Castro is himself a Communist or a mere figurehead for the Reds is immaterial just now. The facts are that his administration shows all the signs known Communists put in key jobs, a "hate America" campaign, a program of capitalist baiting, a police state, and the creation of a political snake pit which is alarming the whole Caribbean.

The fact that Castro ousted Batista, a recognized despot, no more excuses his subsequent conduct than did the activity of George Jacques Danton in overthrowing the despotic French aristocracy excuse his subsequent reign of terror.

Vague though my understanding of Castro's agrarian reform plans may be, I am aware that in breaking up the large holdings he is breaking up the vital Cuban sugar industry, which can no more operate refineries on fragmented small farms than could Mao Tse-tung's communes operate blast furnaces on the village level. Furthermore, Castro is not giving the land to the small holders, he is leasing it to them under state supervision -- which to me sounds very much like the first step toward Soviet-type agrarian cooperatives.

Mr. Pearson makes a profession of sticking out his neck, and he has had his encounters with the headsman. This, however, does not seem to be one of them. Nor am I the only American who understands the Communist language who is looking south with mounting alarm.

LAWRENCE A. PERKINS,
Falls Church, Va.

[Redacted]

SEARCHED [] INDEXED []
SERIALIZED [] FILED []

[Redacted]

[Redacted]

b3
b6
b7C
b7E

C

A9

Cuba Relations At Dead End

By Jules Dubois

Chicago Tribune Press Service

HAVANA, Aug. 30—A dead-end street has been reached in relations between the United States and Cuba.

Relations have deteriorated and have reached a virtual stalemate here under the guidance of Premier Fidel Castro.

For two months U. S. Ambassador Philip W. Bonsal has sought an interview with Castro but Castro has avoided the meeting. Bonsal has hopes of ironing out any peevish Premier may have regarding United States intentions toward Cuba.

Herter Relayed Plea

Secretary of State Christian A. Herter exchanged views with Cuban Foreign Minister Raul Roa in Santiago, Chile, on Aug. 15. Herter told Roa that the United States desires good relations with Cuba and asked him to urge Castro to see Bonsal. Castro still has not agreed to see Bonsal.

As Castro is the only one who can determine foreign policy and the only one who can order a halt of the doses of hate-America poison in the Cuban press and radio, Bonsal has been eager to set the record straight.

Castro appears to be saturated with misconceptions and prejudices against the United States and these have been intensified since he was criticized because of his land-redistribution program.

He blames the United States for accusing him before the world of promoting invasions in the Caribbean. No such direct accusation was made, but Castro and his henchmen did sponsor invasions.

Timed With Red Visit

The hate-America campaign was turned on full blast at the time in May when Vadim Kotchergin, a Russian agent, was visiting Cuba.

Kotchergin accompanied two Russian trade union leaders, Timofey Bremin and Ivan Arnov, to Havana as guests of the Cuban Confederation of Workers. Kotchergin was listed as interpreter.

Gen. Charles P. Cabell, assistant director of the Central Intelligence Agency, told the American Legion's security commission in Minneapolis last week that Kotchergin's mission was to instruct Cuban Communists on how to penetrate Castro's government.

SEARCHED INDEXED
SERIALIZED FILED

AUG 31 1959

b3
b6
b7C
b7E

U

CUBA

U. S. Ambassador Philip W. Bonsal has been seeking an interview with Cuban Premier Fidel Castro for nearly two months, but Dr. Castro has avoided the meeting, and relations between the two nations have deteriorated to the point of a virtual stalemate, Jules Dubois, Chicago Tribune correspondent said in a dispatch from Havana.

One bright spot in the generally dim economic picture of Cuba is provided, said R. Hart Phillips in a dispatch to The New York Times, by the good business of small merchants and manufacturers of low-priced products under the Castro regime. He said there has been an upsurge in sales of food, soft drinks, beer and textiles.

SEARCHED... INDEXED...
SERIALIZED... FILED...
AUG 31 1959

b3
b6
b7C
b7E

Appeasing a Bungler

THERE'S a point where patient tolerance becomes obsequious humility and that point, it seems to us, about has been reached in Cuba.

For nearly three months, U. S. Ambassador Philip W. Bonsal has sought the honor of an interview with Fidel Castro. Sr. Castro won't see him.

At Santiago, Chile, a short time ago, Secretary of State Herter conferred with Cuban Foreign Minister Raul Roa. Mr. Herter asked Sr. Roa to ask Sr. Castro to see Mr. Bonsal. Still no interview.

If and when Sr. Castro condescends to talk, he will be told that the United States isn't trying to trip him up, that the United States wishes Cuba nothing but the best.

Actually, these are things Castro knows already, if he wants to know or is capable of understanding. If he

doesn't or can't, the proposed interview would be futile anyhow. It only would give him an official audience for the libels he has spread about the United States Government.

Many of the troubles of this bungling world-saver are due to his own incompetence.

We suggest that this continued fawning upon him is well beneath the dignity of our own Government. It can't help Cuba or the Cubans who are going to have to suffer thru another round of dictatorship—by whatever name you call it—in their distressingly tedious progress toward eventual, decent self-government.

The State Department should call Ambassador Bonsal home for lengthy consultations, relieving him from embarrassing residence in a country where he obviously isn't welcome.

SEARCHED []
SERIALIZED []
SEP 2 1959

b3
b6
b7
b7

Several Held In New Plot To Kill Castro

PINAR DEL RIO, Cuba, Oct. 18 (AP)—A plot against the life of Prime Minister Fidel Castro was broken up today with the arrest of a group of former soldiers and peasants, unofficial sources reported.

The arrests were made at Vinales, 15 miles from Pinar Del Rio. One North American was reported in the group, but he was not identified.

The informants said the plan was to shoot Castro when he visited Vinales later this week with delegates from the convention of the American Society of Travel Agents. There was no official confirmation.

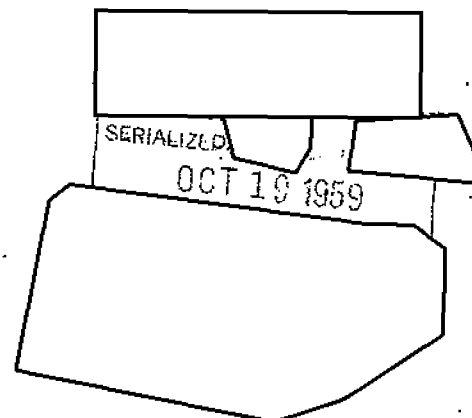

b3
b6
b7C
b7E

Castro Knows Better ^{Arb}

Hitler and Mussolini proved that it is no great trick for a dictator, if he is sufficiently heedless of ultimate consequences, to whip up the fury of the mobs. Fidel Castro can—and is—proving it all over again.

Thus, it was easy for Castro to call the peasants and the workers into Havana, and to stage his own comic opera entrance with the aid of a helicopter and an automatic rifle. The mob roared its approval, as any mob would do. It was easy for Castro to obtain a shouted approval when he called for the execution of Major Hubert Matos, a once trusted lieutenant of the revolution who has been doomed because he challenged the Cuban drift toward the Communists. Easiest of all, perhaps, was the false and hate-engendering suggestion that the United States is permitting planes based on American territory to "bomb" Cuban civilians. This is heady stuff, and it may serve for a while to divert the minds of the poverty-ridden Cuban people from more basic things—food, shelter, clothing, etc. But Castro, we think, knows better, and it is pertinent therefore to ask: Why is he doing this?

Two reasons, singly or in combination, are indicated. One is that Castro, a bare 10 months after winning his revolution, is hopelessly incapable of coping with the opportunities and the responsibilities of that victory. The second is that Castro, who probably is not a Communist himself, is being pulled more and more into the orbit and under the influence of the Communists who have infiltrated his revolutionary movement. Or—again—it may be a combination of the two.

In any event, from Washington's point of view, there is plenty of reason for the gravest concern over the direction which the Cuban revolution is taking. The resurrection of the firing squads and the hate-America propaganda will solve nothing. Nor is there any discernible evidence that Castro is capable of coming up with better answers. If events confirm this view, then Fidel Castro's 26th of July Movement will turn out to have been nothing better than a prelude to chaos—or worse.

SEARCHED [] INDEXED []
SERIALIZED [] FILED []

OCT 29 1959

b3
b6
b7C
b7E

RALPH MCGILL

A 27

Castro Defeating His Own Goals

Leader Attacks U. S. While He Seeks To Attract American Tourists to Cuba

"Fidel" said one of Cuba's economists soon after the victory of the Castro revolution "is at once our greatest asset and liability. He is an inspiration; he is a disorganizer. He will not give attention to detail. Yet details cannot be attended to without him."

At that time most of Cuba was on an emotional jag such as follows: any revolution against a monster such as Batista. Many persons had suffered and died in the long struggle against tyranny. Those from the outside who shared the pleasure of Batista's removal could not really assay the situation.

One thing was sure: The masses of people—the long-exploited, miserably poor, illiterate peasants—were for Castro. So were most of the teachers and intellectuals. They still are his loyal supporters. The peasants will never again go back to their old status save under the most severe repression.

In those early days there was always the presence of doubt. The economist's summing up was apparent. Fidel was a person of tremendous energy and enthusiasm. He could, and did, inspire. But he was not a man for the necessary boredom of bureaucracy. He was not suited for sitting in an office and making decisions. Yet, nothing could be done without his okay. And this was not easy to come by. Often he could not be found for hours. When found he was not always ready to give attention. So doubt persisted.

The curious instability of the man's make-up is revealed most clearly in his sincere efforts to have tourists come back to the island. It is a magnificent place to go for pleasure, for sight-seeing, for relaxation. The people are friendly. The climate is unsurpassed. Tourist dollars were as great a source of income as sugar. And, from the start, Castro has urged tourists to come. Recently he set aside the sum of \$50,000 to entertain a convention of travel agency and tourist organizations.

Yet, while he does this, he denounces the United States. He stirs up ill will against its people and its Government. The Cuban peasants, who never thought of entertaining hatred, are being taught it.

This is senseless. It defeats what he seeks to do. Agrarian reform was long overdue in Cuba—as it is in other Latin nations. Mexico, which some years before seized the oil wells owned by the United States and European interests, brought off reform without too much difficulty. The wells were paid for. Land was then taken from foreign owners. But the schedule was not abrupt. There was just compensation.

The Roosevelt administration assisted the Mexicans to do this. The owners were not happy. But in time the improvement in the Mexican economy demonstrated the wisdom of the moves.

Castro could have had similar support. But from the

start he seemed to prefer bad advice. Few persons in Cuba or out believe he is a Communist. But he consistently has given ear to some very unsound advice. He has ignored suggestions from those regarded as pro-United States. Some persons in his cabinet admitted Communists have infiltrated lower echelons of the military and government. There is evidence they have, quite typically, presented themselves as nationalists and have been, and are, sabotaging Castro with anti-American propaganda and urging plans which cannot succeed without United States co-operation.

That Castro should be so inexperienced as to believe he could bring off necessary agrarian reforms without large cash reserves and credits is unthinkable. Yet, he was so persuaded.

Members of his cabinet who are not beguiled by the extreme nationalists and Communist propaganda know that the only way out is for an equitable working agreement with this country. Cuba's trade program is handicapped by the fact that her neighbors all grow bananas, tobacco and coffee. Even the Russians can help her but little.

There seems to be a falling away of popular support among the teachers, students and the small middle class of Cuba. The large landowners, gambling interests, and many of the top businessmen were never for him.

That Castro should have been so unresponsive to common-sense realities is tragic. The processes of economics always have bills coming due.

SEARCHED
SERIALIZED
INDEXED
FILED
OCT 29 1959

b6
b7c

b3
b7E

C

WILLIAM S. WHITE

Behind Castro's Goading of U. S.

Cuban Leader Seen Attacking Us To Cover Up Conditions at Home

Fidel Castro of Cuba is putting the United States Government into an increasingly uncomfortable position. This bearded mouse is not merely annoying the Yankee lion. He is also causing serious anxiety here about the already far-from-stable areas of the Caribbean.

His may be only a tin-pot demonstration of hostility against us; but it can have unpleasant echoes, all the same.

Responsible men in our Government hope Castro can be dealt with impersonally and in a collective way through the Organization of American States. We have no wish to be forced to take steps alone that would permit him to bellow still louder about United States "imperialism."

So, Washington will try its best to canalize his alleged discontents into the Inter-American Peace Committee's jurisdiction. We are perfectly willing to submit to the verdict of that Pan-American agency as to whether we are mistreating Cuba—or whether Cuba is becoming a common nuisance in the Pan-American world.

The big question is: But will Castro himself accept the referee?

That he is acting like a dictator is surprising only to one group, since he is a dictator and always was. These are the misty-eyed reformers who, only a few weeks ago were howling hosannas to Fidel Castro as a latter-day Abraham Lincoln. They sprang gladly and automatically to his side.

They did so because they

see all public affairs, foreign or domestic, with great simplicity. Every politician is either a translucent ("liberal") angel or the blackest of ("reactionary") devils. Naturally, they did not wait to see whether even on Fidel Castro's halo there might be a bit of tarnish.

For Castro's predecessor, Fulgencio Batista, was a very bad man, as they reasoned—and correctly so, as far as that goes. Castro was fighting this very bad man. Thus, Castro obviously was a very good man. (True, there was the inconvenient fact that his firing squads were killing people quite as dead as Batista's had done—but these, of course, were bad people.)

The reformers were entitled under the guarantee of free speech to take up this extraordinary view. Still, it really is a pity they did, inevitable though it was. For much uninformed opinion was created, in this hemisphere and everywhere, that the good young Castro had brought only "democracy" where the bad old Batista had worked such ill.

All this, however, seriously hampered the United States in dealing realistically and factually with the Castro problem. And the big buildup now helps him to insult the United States in comparative safety—and with an impertinence of distortion that is very able propaganda.

The fact is that his regime could not survive six months if the United States really retaliated. Cuba's economy rests on the United States. As a good friend of Latin America, Senator George

Smathers of Florida, points out, Cuba would not last long if we went elsewhere for sugar.

But of course we do not contemplate sanctions against Castro. Nor do our leaders lie awake in fear that Latin America will explode because of him. Nor do they accept the second of the two extreme opinions of Castro—that perhaps he is some powerful force for international communism.

How, then, is he actually seen by those in our Government who must work out this sticky little problem? First, he is one of the world's irresponsibles, the fellows who are agents not of communism but only of ineptitude and disorder. Second, he has picked the United States to attack because he needs a foreign devil to beat at to divert attention from happenings in Cuba, itself.

While he is still in control, his revolution is faltering here and there. Some patriotic Cubans originally driven to him by Batista's long excesses are beginning to part company with Castro. This is his business and his alone. We are not "anti-Castro." We are against one thing only: We are opposed to chaotic government anywhere in the Caribbean because we want peace and order to prevail there.

SEARCHED	INDEXED
SERIALIZED	FILED
NOV - 1 1959	

b3
b6
b7C
b7E

Handwritten mark

SEPTEMBER 14, 1959

WASHINGTON DAILY NEWS

IN HAVANA, A 2-FRONT COLD WAR

They Call Him 'Not Good Jules'

HAVANA, Sept. 14—Jules Dubois, Latin American correspondent for the Chicago Tribune, is facing a two-front cold war here:

On one front is the Restaurant and Hotel Workers Union, which charges that Mr. Dubois defamed Prime Minister Fidel Castro in some articles last week.

Therefore union members are under orders to serve Mr. Dubois in no way — no room service and restaurant service, no phone calls nor elevator service.

Mr. Dubois, who arrived

here Saturday, did register at the Havana Hilton but was refused restaurant service later. He finally got food at a cafe across town.

When Mr. Dubois wanted to leave the 22d floor, where his suite is situated, he received no elevator service until he was taken down by an assistant manager.

When Mr. Dubois requested breakfast in his suite, he didn't even get a glass of water. Later he found a note on the lobby bulletin board reading: "Jules Not Good Dubois."

On the second front, Mr.

Dubois faces action by the National Association of News-papermen, which today takes up a resolution naming him persona non grata. The resolution already has been approved by group within the association, altho over considerable objections.



JULES DUBOIS

*Lt. Col. Jules Dubois
15-997**

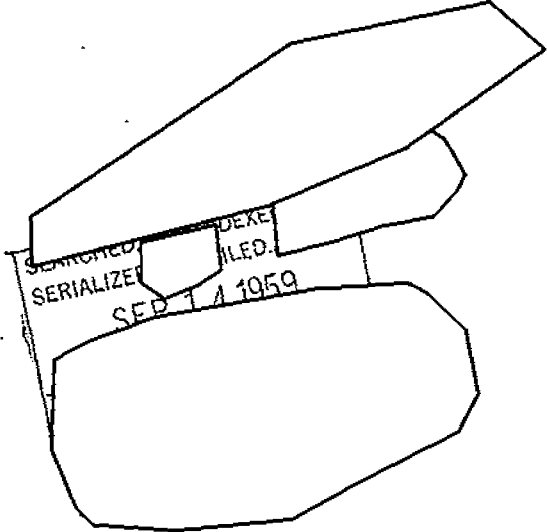

SEARCHED
SERIALIZED
INDEXED
FILED
SEP 14 1959

b3
b6
b7
b7D

U-4821 LE HURMET-EE YAGNOM EWEM T. DAG NOT
4-THE WASHINGTON DAILY NEWS, MONDAY, SEP



Today's Big Threat New Leftist Drive Aided by 'Fidelismo'

By VIRGINIA PREWETT

The big-threat to Latin American stability today is not the highly-publicized invasion-fever of Cuba's Fidel Castro against Trujillo-type dictators, but a new extremist drive sparked by "fidelismo" within the hemisphere's left-wing and democratic movements.

When Dr. Castro first entered Havana, he stirred anew the dreams of the dispossessed and won widespread sympathy. Then on July 26 he took his long leap leftward by personally ousting anti-communists from Cuba's revolution. Significantly, Lázaro Cardenas stood at his side that day.

SAME TACTICS

As leader of Mexico's revolution in the 1930's, Sr. Cardenas used inflammatory speeches and the expropriation of American properties without adequate compensation to set the continent aflame with anti-Americanism. These are Dr. Castro's tactics and his avowed aim.

But Dr. Castro is not succeeding as Sr. Cardenas did, mainly because a new breed of seasoned non-communist liberals are powerful in his neighborhood.

Three outstanding leaders, President Romulo Betancourt of Venezuela, President Alberto Lleras Camargo of Colombia and ex-President Jose Figueres of Costa Rica, are either remaining aloof or have openly broken with Dr. Castro. As a result, watchful eyes, rather than willing satellites, encircle him.

AN OPEN SNUB

The Venezuelans, Dr. Castro's closest allies against Dominican Republic dictator Rafael Trujillo, behind the scenes frankly resent Cuba's new "jefe maximo." Sr. Betancourt's followers condemn Dr. Castro's egotism in hailing the people of Venezuela by radio from his airplane like a demi-god arriving from the clouds when he made his triumphal visit to Caracas.

Privately they remind you that Sr. Betancourt, then President-elect, did not welcome him at the airport, an open snub.

Yet even the most hostile to Dr. Castro admit he has activated in Latin America a whole new crop of young would-be messiahs anxious to perform revolutionary miracles.

"Dr. Castro has a gimmick," a Venezuelan said to me bitterly. "It's the beard—it fascinates the young people. I think if Dr. Castro shaved his chin, the Cuban revolution would collapse!"

HARD-BITTEN REDS

No political barber is in sight, however, and the young Latin American beardniks fired by Dr. Castro's dramatics have gained formidable allies. These are the hard-bitten, wily and deeply entrenched native communists. Since July 26 they have grown so bold that Brazil and even Mexico, never too tough on them, have had to take steps. Mexico's top communist has been jailed.

The surface issue now being fought out in Latin American leftist and liberal ranks is how fast admittedly needed reforms can be pushed forward. The real issue lies deeper. The Latins, whom we call neighbors are actually our partners, providing our second greatest overseas market, our first source of supplies and an important investment field. To destroy that partnership and use the bait of reform to hook more people into slavery is the object of the accelerated extremist drive.

b3
b6
b7C
b7E

SEARCHED	INDEXED
SERIALIZED	FILED
SEP 14 1959	

EMBER 7, 1959

Mexico is Cool to the Cuban

Castro Even Embarrasses Leftists

By ED TOMLINSON

MEXICO CITY—Fidel Castro's prestige has sunk to a new low in Mexico:

The responsible Mexican press, leaders in the business and professional world, as well as most high officials of the Federal Government make no bones about their disgust with Castro's histrionic performances.

President Lopez Mateos's recent statement in the United States that the "Cuban regime is not communist" has been widely criticized.

Such Mexico City dailies as Excelsior and El Universal

treat the Fidelist marathon speeches and pronouncements with what one Mexican reporter called "belittling scorn," when they mention them at all.

Some local radio commentators continually refer to him as "the bearded monster."

Castro and his chief henchmen have made numerous attempts to wangle invitations to visit Mexico officially, but the government has not found it convenient.

Only a week ago it was announced in Havana that the new "financier" of the Cuban Government, Ernesto "Che" Guevara, would fly to Mexico

City to invite Anastas Mikoyan to stop over in Cuba on his way home from Mexico.

The reaction against it was so swift that "Che" himself thought better of the project and sent a substitute in the person of Hector Rodriguez Lombardi, an unknown functionary of the Castro official household.

Upon his arrival in the Mexican capital, Senor Rodriguez Lombardi announced that in addition to inviting the Russian Deputy Premier to visit Cuba he hoped to talk to President Lopez Mateos and former President Lazaro Cardenas.

Neither of the distinguished Mexicans received him.

SEARCHED		INDEXED	
SERIALIZED			
DEC - 3 1959			
FBI WASH. F. O.			

b3
b6
b7C
b7E

Washington Post and Times Herald
July 30, 1960 page A-8

Mystery in Havana

"What is wrong with Fidel?" This ~~is the~~ question now being ~~urgently~~ asked in Cuba, where the curious behavior of Prime Minister Castro is fousing more and more speculation. Reportedly, Mr. Castro was stricken a month ago by pneumonia, but on July 26 he stood in the driving rain high in the mountains during a revolutionary celebration while his doctor stood next to him. This is strange treatment for a patient recovering from pneumonia. In any event, the Prime Minister's sickness is sufficiently serious that his brother Raul has cut short a visit to Eastern Europe to hasten back to Cuba.

In Cuba, Fidel Castro is widely regarded as a demigod immune to the troublesome diseases that afflict mere mortals. But his sorcery has shown itself to be increasingly ineffective. It is said that a first-class row is developing over Foreign Minister Raul Roa's inept handling of Cuba's case at the United Nations. The Cuban revolution has reached a critical stage, and it is small wonder that Mr. Castro feels ill. Perhaps one explanation for the leader's infirmity is that he now realizes to what extent he is the prisoner of his brother Raul of Ernesto (~~Ono~~ Guevara, and of their pro-Communist clique.

SEARCHED	INDEXED
SERIALIZED	FILED
JUL 30 1960	

b3
b6
b7C
b7E

A-4

Severe Illness Rumors Denied by Castro Aide

HAVANA, July 29 (AP)—Despite increased speculation, a top aide of Fidel Castro said today the Cuban Prime Minister is not seriously ill.

The aide, who declined to be identified, said Mr. Castro is convalescing from minor surgery at his home in suburban Cojimar. The aide denied reports that Defense Minister Raul Castro was summoned home from his state visit to the United Arab Republic because of his brother's illness.

He said Raul was the last stop on a European tour that included Czechoslovakia and the Soviet Union and the young armed forces chief had been expected home last Tuesday.

Nevertheless, diplomatic sources said Raul's decision could have stemmed from concern about his brother's health. No official source would confirm the younger Castro had been called home.

Raul Castro, as second man in the country's military government, is likely to take over a larger share of duties if Fidel

is sidelined for any length of time.

Fidel Castro's health has been the subject of conjecture here that has increased since he appeared at a rally marking the anniversary of his 26th of July movement in the Sierra Maestra Mountains Tuesday.

At that meeting Mr. Castro spoke of his health. He said it had prevented his taking part in pre-rally ceremonies and that his doctor had recommended rest.

He appeared haggard and

drawn and his voice grew steadily hoarser in his 2 1/4-hour television speech. When the speech was finished, he turned and practically stumbled into the arms of his aides.

Mr. Castro has been seen infrequently in public since he was stricken July 9 with what his doctors diagnosed as pneumonia.

The best information is what, while confined to his home, he is well enough to conduct state business.

The situation at the Castro home appears normal. There is the usual heavy guard and no one available to answer inquiries.

SEARCHED. INDEXED

SERIALIZED

AUG 2 1960

b3
b6
b7C
b7E

Castro's Fiasco

FOR weeks the propagandists for Fidel Castro have been building up the 7th anniversary of "The 26th of July Movement"—it was on July 26, 1953 that Castro made his first abortive attempt to unseat the Batista dictatorship.

The site was the Sierra Maestra—the range of mountains in Southeast Cuba where Castro launched the drive which ultimately brought him to power.

Havana and the entire countryside for weeks had been plastered with posters and signs saying "to the Sierra with Fidel." The Castro hacks predicted upward of two million people would respond. A three-day holiday—Monday, Tuesday and Wednesday—was declared to allow the people time to get there and back, altho the time is to be made up with extra hours of work all of next month.

On top of everything else, there were torrential rains for two days, turning the area into a quagmire.

The result was that only about 250,000

persons made the trek into the mountains—and Castro, only recently up from a sick bed with what his doctors said with pneumonia, was most subdued. Some of the reports indicated that most of those who went to the Sierra with Fidel were his revolutionary forces and the new "Peoples Militia" who had no choice.

This was the second public rebuff Castro has suffered this month. On July 10 he was supposed to address a big mass meeting in front of the Presidential Palace in Havana—with predictions that a million Habaneros would show up. When only about 100,000 showed, it was announced that Castro wouldn't show either—that he was sick.

Just as it takes more than one swallow to make a spring, it will take more than two public fiascos—we fear—to get rid of Castro. However, it is encouraging that the consequences of Castro's communist-dominated dictatorship have cooled the enthusiasm of the Cuban people for the man they are increasingly convinced is their betrayer rather than their liberator.

SEARCHED		INDEXED	
SERIALIZED		FILED	
AUG 2 1960			

b3
b6
b7C
b7E

Castro, Needing Rest, May Yield to Brother

HAVANA, Aug. 1 (AP).—One of Fidel Castro's doctors said today the ailing Prime Minister needs "absolute rest — both physical and mental."

The statement by Maj. Raul Trillo, an army doctor treating Mr. Castro, was published in the semiofficial newspaper Revolution. It reported Mr. Castro is convalescing but said "now we have to build him up after his illness."

"Treatment with antibiotics ended a week ago," Maj. Trillo's statement said, "and now he is on a treatment of absolute rest with a good diet and vitamins to recover rapidly and completely."

Mr. Castro's continuing illness has generated growing speculation that he may yield control of his government—at least temporarily—to his Yankee-hating brother, Raul, once described by Fidel as even more radical than himself.

Maj. Trillo's passing mention that Mr. Castro needed mental as well as physical rest caused considerable surprise in Havana. It was the first time there has been any indication he required anything more than physical convalescence.

Supports Rumors

The doctor's statement tended to support rumors that the Prime Minister plans an official leave of absence. This would normally require a cabinet meeting, but sources at the presidential palace said no meeting had yet been called.

Revolution did not mention the rumors that Mr. Castro may step aside.

Maj. Trillo's statement said



RAUL CASTRO
More Radical Than Fidel
—AP Wirephoto

it is possible that Mr. Castro's public appearances since his illness had delayed his recovery. Mr. Castro traveled to the Sierra Maestra for ceremonies marking the anniversary of his 26th of July movement. He spoke there for more than two hours in the rain.

Had Lung Infection

"It is natural," Mr. Trillo said, "that he has lost weight in view of this illness. But now, with the order for rest and good feeding, he is recuperating rapidly. There is no reason whatever for alarm and I can assure that Fidel Castro soon

See CASTRO, Page A-11

CASTRO

Continued From First Page
will be able to resume his activities as before."

Maj. Trillo's statement made no further diagnosis of Mr. Castro's illness other than his lung ailment.

"I can assure you that the lung infection has disappeared completely and the lungs now are clear," Maj. Trillo said. "What is more, pneumonia is one illness that, thanks to antibiotics and other resources of modern medicine, has ceased to be dangerous as it was formerly when this illness was considered grave."

Government-controlled radio stations broke their ban on Sunday newscasts to report that the Prime Minister—only 13 days away from his 34th birthday—is "still convalescing" despite official reports two weeks ago that he had recovered fully.

The surprise announcement said Mr. Castro now is "improving satisfactorily." It did not say what he was suffering from.

After he was stricken July 9, Army doctors said Mr. Castro had a "pneumonic" infection of the left lung. This was generally interpreted to mean pneumonia. But there have been rumors of a more serious illness, including a suggestion major surgery would be necessary.

Dr. Antonio Rodriguez Diaz, who has been treating the Prime Minister for some time, today was reported by his aides out of the country on professional business. There was speculation that his trip might be in connection with Mr. Castro's illness.

One rumor said Mr. Castro would go to Moscow for treatment. Mr. Castro's last public appearance was at the 7th anniversary celebration of his 26th of July revolutionary movement in eastern Cuba. He looked haggard and worn.

Maj. Raul Castro, minister of the armed forces, returned Saturday from a European trip that took him to the Soviet Union and a meeting with Premier Nikita Khrushchev, Czechoslovakia and the United Arab Republic.

SEARCHED INDEXED
SERIALIZED FILED
AUG 2 1960

b3
b6
b7C
b7E

Castro Illness Reported as TB

Cancer Rumors Are Discounted

By JOHN V. HORNER
Star Staff Writer

Cuban Prime Minister Fidel Castro is suffering from tuberculosis, according to authoritative sources in Washington. The disease, these sources said today, is confined to one lung.

There was no indication how far the disease has progressed, but the diagnosis apparently convinced officials here that other reports about Mr. Castro's condition were erroneous.

One well-informed authority rejected rumors that the Cuban leader is a victim of cancer. Cuban authorities have indicated that Mr. Castro contracted pneumonia some time ago.

The Prime Minister's doctors ordered complete rest for him, a customary procedure in the treatment of tubercular patients.

It is expected, however, that Mr. Castro will appear as scheduled tomorrow to address the final session of the Latin American Youth Congress in Havana.

Dispatches from Havana state that Mr. Castro has been in seclusion in the Cienga de Zepata region outside the Cuban capital.

He was accompanied there by his personal physician, Maj. Raul Trillo; his secretary, Celia Sanchez; and a bodyguard said to number 115 men.

SEARCHED INDEXED
SERIALIZED FILED
AUG 8 1960

b3
b6
b7C
b7E

WASHINGTON DAILY NEWS, THURSDAY, AUGUST 11, 1960 25

Edson's Column Had the Figures



Poll: Do You Like Fidel or Do You Want Asylum?

By MILTON GUSS

WASHINGTON'S big problem these days is no longer the 5 per centers, or 10 per centers. The great peril now is from 86 percenters. I refer you to Page 47 of Wednesday's always interesting Washington Daily News in which the headline over Peter Edson's column said: "86 percent back Castro." About 600 other newspapers print Mr. Edson's column and I'd like to blow a small, shrill whistle on this statistic.

At first I figured this meant 86 per cent of Castro's relatives or 86 per cent of the members of the Cuban cabinet. Much to my surprise, however, my favorite columnist started out his column: "Eighty six percent of the Cuban people support Fidel Castro's Revolutionary Government. . ."

Even if you don't count the number of Cubans who have fled the country, or who were executed or who are sweating it out in foreign embassies, that figure seems more than a little high to me.

SLIPPING

Granted, Fidel is still the most popular man in Cuba. But everyone, even his staunchest supporters, agree he has been slipping. Some say his popularity has sunk to 40 percent. Most followers put the figure at 60 percent. But 86 percent! Mr. Edson has topped them all, except modest Fidel himself, who told the editor of The Washington Daily News in February, 1959—right after he took Havana—that a poll showed he had 90 percent of the people with him.

In all fairness to Mr. Edson, usually one of the clearest pundits in the business, he based his column on a study under the direction of The Institute for International Social Research.

thing is certain, that survey didn't interview any of the thousands locked up in prison or the hundreds who daily jam the U. S. embassy, applying for visas to get out of the country.

REFUSE REPLIES

Frankly, I'm not surprised that few people refused to answer those questions. By now, Cubans are used to being quizzed by secret police and know what they're supposed to say when they're asked whether or not they like Fidel. Once upon

a time a poll showed 90 percent of the German people were for Hitler, for the same reason.

The survey adds that 8 percent rate the Castro regime worse than Batista's, and 3 percent figure they are about the same. Comparing the two regimes plays right into Castro's hands; his propaganda machine has steadfastly maintained that all "counter-revolutionaries" are a pro-Batista minority.

Actually, thousands of disillusioned revolutionaries agree Batista was even worse than Castro is today, but they feel that somehow there must be a better choice in life than between two rascals.

At the end of his article Mr. Edson casually informs us that the survey was taken last May.

Well, there have been a lot of defectors over the dam since then.

Mr. Free's so-called scientific samplers, in a nation of 6,500,000 people, called on only 1000 interviewees and none of them in rural areas, which is where 40 per cent of the population lives.

Maybe the replies were from brother Raul, army personnel and workers in the offices of the Agrarian Re-

Redacted area containing a stamp: AUG 12 1960

b3
b6
b7C
b7E

Ready-Made World Forum

Urges Fidel Join K in UN Song-Dance

HAVANA, Cuba, Sept. 12 (UPI)—Premier Fidel Castro's top advisers are urging him to join Soviet Premier Nikita S. Khrushchev at the UN General Assembly to dramatize Cuba's strong ties with the communist bloc, diplomatic circles said today.

Khrushchev, now en route by ship to United Nations headquarters in New York, has called on the heads of government around the world to attend the session beginning Sept. 20.

Thus far there has been no definite indication whether Castro would respond. But the diplomatic sources said Castro's advisers want him to attend to strengthen the "Sino-Soviet bloc" and emphasize Cuba's defiance of the United States and Latin America.

The General Assembly would provide a world forum for Castro to denounce United States and Latin America and plug his "Declaration of Havana"

"The Declaration of Havana" was Castro's answer to the "Declaration of San Jose" in which 19 members of the Organization of American States (OAS) condemned Soviet-Sino penetration of the Western Hemisphere, and indirectly chided Cuba for its ties with international communism.

The crux of the Declaration of Havana is that the United States poses a greater threat to Latin American countries than either Russia or communist China.

Informed sources reported Defense Minister Raul Castro was preparing a hand-picked force of about 2000 troops to flush an estimated 800-man anti-Castro guerilla band out of the Escambray Mountains in Las Villas Province.

Castro himself admitted publicly last week the existence of the guerilla force but

warned they would be wiped out.

There were reports also some of the largest sugar interests were planning to transfer all mill holding "voluntarily" to the Agrarian Reform Institute. Informed sources said the move is being contemplated because of the critical bank situation resulting in the unavailability of needed funds for readying plants for the coming sugar harvest.

7 9-12-60

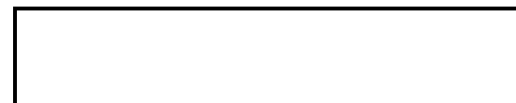

SEARCHED
SERIALIZED

SEP 14 1960



b3
b6
b7C
b7E

U. S. Orders Curbs On Castro's Visit

WITTING BEAR
A-1 Date 9-14-60

Restrictions Same as for Khrushchey

By ROBERT E. CLARK
Star Staff Writer

The United States notified the Cuban Government today that Premier Fidel Castro will be subject to the same travel restrictions as Soviet Premier Khrushchey when he arrives at the United Nations.

Secretary of State Herter made the announcement in reply to a question at his news conference. He also made it plain that the United States has no intention of backing off the restrictions imposed previously on Mr. Khrushchey.

The Cuban Embassy was advised this morning that Mr. Castro will be limited to Manhattan Island when he arrives in New York as the head of the Cuban delegation to the U. N. General Assembly session opening next Tuesday.

Entirely Free in Role

Secretary Herter said he doubted that the Soviet Premier would be permitted to go outside Manhattan to speak to some groups he was to address even if he made a formal request to do so.

He stressed, however, that Mr. Khrushchey was entitled to complete freedom in any activity directly related to his role as the head of the Soviet delegation to the General Assembly session. Mr. Herter expressed the hope that Americans would meet with their usual courtesy and dignity to the visit of heads of foreign governments.

Secretary Herter said that President Eisenhower, Vice President Nixon, and President Kennedy also are planning to attend the General Assembly session. Mr. Herter said no decision has yet been made as to whether the travel restrictions that apply to Mr. Khrushchey and Mr. Castro also will be imposed on them.

The Secretary indicated he does not anticipate any meeting between Mr. Khrushchey and President Eisenhower in New York next week, although he did not specifically rule out such a face-to-face encounter. The White House announced today that Mr. Eisenhower will address the U. N. Thursday, September 22.

Mr. Herter said that, as far as he knew the President expected to return directly to Washington after his speech.

Discourages "Summit" Move

He commented that he does not think Mr. Khrushchey will have much luck if he attempts to turn the U. N. meeting into a "summit conference" of heads of government. He pointed out that the very size of the General Assembly would make it difficult for the Kremlin chief to do much more than participate in committee meetings as the head of the Soviet delegation.

The Secretary showed some optimism over the Congo situation. See CASTRO, Page A-4.

SEARCHED
SERIALIZED
SEP 16 1960

b3
b6
b7C
b7E

CASTRO

Cuba Due to Follow Communist Line

Continued From First Page
ation but stressed that it is still so fluid that it is almost impossible to appraise. Outside of the Congo capital of Leopoldville, he said, things seemed to be much quieter with the civil strife abating.

He spoke in graver terms of the East German action in making it more difficult for Westerners to enter the country.

It is now very clear that the Soviet was consulted by the East German government before the travel curbs were imposed August 31, Mr. Herter said. The United States regards this as a serious matter, he declared.

Conditions Discharged

He said that as far as he knows there has been no change whatsoever in the conditions President Eisenhower has set as a preliminary to a possible meeting of himself and Mr. Khrushchev. These include the release of the two surviving crewmen of an American RB-47 plane who are being held for trial by the Russians.

No invitations have yet been issued to any of the heads of government who are attending the U. N. meeting to visit Washington, Mr. Herter said. A questioner suggested that it would be awkward to invite other foreign leaders while restricting Mr. Khrushchev and Mr. Castro to New York.

Following Soviet Line

The Associated Press reported from Havana today that Cuban Foreign Minister Paul Roa has made it plain that Mr. Castro will go down the line with the Soviet bloc. His aims were outlined as follows:

1. Seating of Red China in the U. N.

2. Recognition of Algerian independence.

3. Support for Patrice Lumumba as Congo Premier.

4. Denunciation of United States "imperialistic policies."

Included in the 10-member delegation besides Mr. Castro and Mr. Roa, will be Agrarian Reform Chief Antonio Nunez Jimenez and Manuel Bisbe, Cuba's permanent U. N. delegate.

The government radio station Voz reported Mr. Castro and his party will fly to New York Sunday.

Back Reds in Congo

Mr. Roa made it clear last night in a speech to university students that the Castro government will go down the line with Communist bloc countries. He declared the U. N. representation of the Chinese people "no longer could correspond" to the government of Nationalist China on Formosa.

The government-controlled press repeatedly has voiced editorial support of the Soviet position on the Congo.

It was a foregone conclusion that Mr. Castro will take advantage of the occasion to level another vitriolic blast at what he has termed United States physical and economic aggression.

Mr. Castro's trip will mark his first meeting with Mr. Khrushchev and Mr. Nasser, both of whom he has invited to visit Cuba and both of whom have accepted without setting a date. There was a possibility that Mr. Castro would offer to escort both Mr. Khrushchev and Mr. Nasser on a visit to Havana.

U. S. and U. N. Assailed For Castro Restriction

HAVANA, Sept. 15 (AP).—Both the United States and the United Nations were blasted today by Revolución for the Washington orders restricting Prime Minister Fidel Castro and three Communist leaders to Manhattan Island when they attend the United Nations General Assembly next week.

The Castro-controlled newspaper said excessive precautions have been outlined in New York because of "a desire to limit the (American) public's knowledge."

The result, Revolución said, is "a wave of discontent, exactly the reverse of what officials there expected."

The newspaper blamed both the U. N. and the United States for what it termed "the illegal maneuver" of barring the public from attending the General Assembly sessions.

Hits Ship Search

Revolucion also decried as illegal maneuvering a proposed search of the Soviet ship Baltika when it gets to New York with Soviet Premier Nikita S. Khrushchev. The paper said the FBI wants to check the vessel.

"Confining Khrushchev, Castro and other national political leaders to Manhattan reflects not fear of supposed dangers to their lives but fear that their presence would result in popular demonstrations supporting them," it said.

On the home front here, the independent newspaper Informacion disclosed that a Cuban army lieutenant has been killed, apparently in a clash with insurgent forces in the Escambray hills of Las Villas Province.

The announcement said municipal authorities at Santa Clara certified the gunshot death of Lt. Osvaldo Cortina Fernandez, 33, a member of the Military Investigation Department—Castro's secret police.

Many Casualties Reported

Lt. Cortina Fernandez was said to have died after a mid-air collision between two aircraft in the area. Informacion mentioned no other casualties but travelers from Las Villas say a large number of dead and wounded Castro-militiamen were brought to a tuberculosis sanitarium in the Escambray hills.

Informacion said it learned unofficially that many of Mr. Castro's top military leaders have gathered at La Campana, the military headquarters in Las Villas Province, to direct operations against the guerrillas.

The strength of the anti-Castro bands known to be operating in the hills has been

placed unofficially at between 300 and 1,000 men.

The army lieutenant's death was reported by neither Revolución nor El Mundo, both government-controlled publications.

Latins "Look to Castro"

The newspapers reported that Latin Americans in New York, Texas, New Mexico and California look upon Mr. Castro as "the leader of their aspirations." They gave that as the reason for United States State Department travel restrictions on Mr. Castro's visit.

Revolucion, organ of the Castro 26th of July movement, carried a front-page cartoon showing the U. N. building—its windows labeled "Fidel, Nikita, Sukarno, Tito and Nasser"—crushing a sweating President Eisenhower.

Along with Mr. Khrushchev, the drawing was designed to link Mr. Castro with three strong nationalist leaders—Presidents Sukarno of Indonesia, Tito of Yugoslavia and Nasser of the United Arab Republic. All are coming to New York for the Assembly session.

"Paroxysms" Cited

From Washington the Cuban government's news agency reported the announcement that Mr. Castro was to lead the Cuban delegation to the United Nations caused "paroxysms of hysteria" among the United States Government, Senators and Congressmen.

"There are fears Fidel will talk to the North American people," read the banner headline in the newspaper. The newspaper said Mr. Castro was being "hounded" in his movements to prevent him from speaking to Negroes and Latin Americans in New York.

The newspapers made plain that the Cuban delegation will align itself with the Soviet bloc and support, among other things, Red China for a seat in the U. N.

There were indications, too, that Mr. Castro may take the opportunity to deliver a speech at the Assembly denouncing the United States. Revolución listed Cuba as one of the issues to be brought up at the session.

SEARCHED	INDEXED
SERIALIZED	FILED
SEP 19 1960	
FBI - WASH. F. O.	

b3
b6
b7C
b7E

Castro Tightly Guarded At New York Hotel

NEW YORK, Sept. 19 (AP).—Cuban Premier Fidel Castro slept late today, under tight security guard at his midtown hotel.

Only a home-made sign hung on a fire escape across the street from his suite, was calculated to disturb him. Drawn in ink on brown wrapping paper, it read:

"Fidel Commie Go Home." Two hundred police stood guard in the pouring rain, but the weather kept almost everyone else inside. Police gave permission for 25 pickets to parade later across the street from the hotel.

The hotel's owner, Edward Spatz, said telephone calls to Mr. Castro's suite went unanswered. Mr. Spatz reported many calls and telegrams commending him for agreeing to limit the Cuban party. Messages came from as far distant as Texas and California, he said.

Withholds Blast

Mr. Castro, whose loud anti-United States speeches have marked recent months at home, has promised to keep quiet until he addresses the U. N. General Assembly.

The bearded Premier flew into New York yesterday to a hysterical welcome from his supporters, mixed later with boos and catcalls from his opposition.

He smiled and waved as he left the plane and said hoarsely: "I want to salute the people of the United States."

Then he added: "My English, the same as the last time, is not so good. All I have to say I will say to the United Nations."

3,000 Watch Arrival

A crowd of 3,000 at Idlewild Airport was waiting to greet the strapping, 34-year-old lawyer. But police kept all but a few hundred at the main gate, nearly two miles from where his plane stopped. They carried banners reading "Welcome Fidel, Give Them Hell," "With Castro Until I Die — Cuba Free," and the like.

As a 50-car motorcade left the airport Mr. Castro tried to stop his car to greet those at the gate, but police hustled it along.

In Havana, Mr. Castro has made hours-long speeches assailing the United States. But Raul Roa, Jr., son of Cuba's foreign minister, said the Premier will hold no news conferences before he addresses the United Nations.

"He will explain everything when he speaks on the 26th," Mr. Roa said. Mr. Castro is expected to join in Soviet denunciations of alleged United States aggression in Cuba and other Latin-American nations, and to urge admission of Communist China to the U. N.

Anti-Castro elements paraded quietly at the United Nations, toured in buses and cars around town, and booted the Premier as his car rolled on parkways through Queens into Manhattan.

The boos grew louder as he pulled up to the Hotel Shelburne at Lexington-avenue and Thirty-seventh street, not far from the U. N. His smile vanished and he strode grimly through the lobby, to shouts of "Commie, Go Home." He went directly to his room on the third floor, accompanied by a dozen bearded bodyguards and a force of about 75 United States, State and city security agents.

The fiery Cuban leader got his first sample of boos and heckling when his car passed through the Queens midtown tunnel.

Later, apartment residents, leaning out of their windows, unleashed a series of loud boos when Mr. Castro arrived at the hotel.

Cheers Drown Boos

But these were drowned out by the cheers of some 1,000 pro-Castro demonstrators who quickly gathered in front of

U. S. WILL PAY IF CASTRO JUMPS HIS HOTEL BILL

NEW YORK (AP).—If Premier Fidel Castro of Cuba doesn't pay his hotel bill—the United States Government will.

Mr. Castro and his entourage are staying in 20 suites at \$20 a day each at the Shelburne Hotel.

One thing is sure—the Cubans are unwelcome guests as far as hotel owner Edward Spatz is concerned.

"I've not a bleeding ulcer," he said yesterday. "Who needs Castro?" Mr. Spatz said he would not have accepted the Cuban delegation if he had not received requests from Secretary of State Harter and U. N. Secretary-General Hammarskjöld.

The question of who would pay Mr. Castro's hotel bill came up and Mr. Spatz said the State Department guaranteed any bills left unpaid by the Castro party.

SEARCHED	INDEXED
SERIALIZED	FILED
SEP 20 1960	
FBI - WASH. F. O.	

b3
b6
b7C
b7E

A-8
**

THE EVENING STAR
Washington, D. C., Monday, September 19, 1960



Cuban Prime Minister Castro grins as he approaches the microphones to speak to welcome after he arrived at New York's Idlewild Airport yesterday to attend the General Assembly session.—AP Wirephotos

SEARCHED	INDEXED
SERIALIZED	FILED
SEP 20 1960	
FBI - WASH. F. O.	

b3
b6
b7C
b7E

b3
b6
b7C
b7E

WASHINGTON DAILY NEWS
Page 1 Date 9-19-60

SEARCHED
SERIALIZE
INDEXED
SEP 20 1960
FBI - WASH. F. O.



SUNDAY TRAVELERS—Cuba's Fidel Castro (left) and his Minister of State, Raul Roa (right) are shown arriving at Idlewild Airport yesterday. Man in center is unidentified. Pro-

Castro demonstrators were at the airport but boos and cheers were mingled when Fidel's motorcade entered New York City. (Story and other photos on Page 7.)

MANHATTAN LIMIT IS PUT ON CASTRO

Like Khrushchev, Cuban Is
Ordered by U. S. to Stay
Close to U.N. Area

By E. W. KENWORTHY
Special to The New York Times

WASHINGTON, Sept. 14 — The United States notified Cuba today that Premier Fidel Castro would be restricted to Manhattan while he is in New York for the United Nations General Assembly meeting.

The restriction is the same as has been imposed on Premier Khrushchev.

The Cuban Embassy was informed by telephone of the curb. The call was made by Edwin E. Vallon, Deputy Director of the State Department's Office of Caribbean Affairs.

Mr. Vallon also told Dr. Aurelio Giroud, Second Secretary of the Embassy, that Premier Castro would be expected to live as near as possible to the United Nations headquarters on the East River.

Announced by Herter

The Assembly's fifteenth session opens there Tuesday. Premier Khrushchev and Premier Castro are to lead the Soviet and Cuban delegations.

The restrictions on Premier Castro were announced by Secretary of State Christian A. Herter at his news conference.

Mr. Herter was asked today what would happen if Premier Khrushchev or Dr. Castro decided to go outside Manhattan and, in fact, went.

After the laughter, in which Mr. Herter joined, had subsided, the Secretary said, "I am afraid that is entirely a speculative question and I couldn't give you

Continued on Page 18, Column 1

U. S. ALSO LIMITS TRAVEL BY CASTRO

Continued From Page 1, Col. 4

any definitive answer to it.

The assumption here, supported by indications from security officials, is that the New York police will have orders to prevent any such excursions.

The explanation offered to the Cuban embassy was that the restrictions were necessary to insure the personal safety of Premier Castro.

Actually, all that the United

States Government knows about Premier Castro's plans to lead the Cuban delegation to the general assembly it has learned from newspapers.

The Cuban Government has not informed the United States Embassy in Havana, nor has the Cuban Embassy here informed the State Department, that Premier Castro will come to New York.

News dispatches from Havana yesterday reported an announcement by the Presidential Palace that Dr. Castro would be accompanied by Dr. Raul Roa, Foreign Minister, Dr. Manuel Bisbey Alberni, Cuba's permanent delegate at the United Nations, Capt. Antonio

Nunez Jimenez, director of the National Agrarian Reform Institute, and Dr. Raul Echmelle Zenes, alternate delegate to the United Nations.

Premier Castro, Dr. Roa and Captain Nunez Jimenez will need visas, but the Cuban Government has not yet made application for them.

State Department officials were asked today what would happen if Premier Castro and his colleagues arrived at New York International Airport, Idlewild, Queens without the necessary visas. The officials said this was a matter for the Immigration Service authorities to decide.

Immigration officials, in

turn, said that if the Cuban delegation had no visas, a quick call would be put through to the State Department for instructions. Presumably, officials said, the visas would be waived to avoid difficulties.

Secretary Herter expressed doubt today that during his visit to Mexico City this week President Adolfo Lopez Mateos would raise the subject of Mexico's possible mediation between Cuba and the United States.

*N.Y. Times
9/15/60*

SEARCHED [] INDEX []
SERIALIZED [] FILED []
SEP 16 1960
FBI - WASH. F. []

CUBAN IN PROTEST

He Goes to the U. N. Rage Over Bill for Party's Suite

By MAX FRANKEL

Fidel Castro stalked angrily out of his hotel last night and went to the United Nations headquarters with plans to stay there until he was given what he would consider acceptable housing.

The Cuban Premier, bitter over what he described as "acceptable cash demands" by the Shelburne Hotel management, took his case directly to Secretary General Dag Hammarskjöld.

He said that if no other housing could be found for him and his associates, or if they could not be accommodated at the United Nations, he was willing to "go any place, even Central Park."

The Premier added: "We are mountain people. We are used to sleeping in the open air."

Leads Delegation Out

The bearded 34-year-old Cuban, in his battle-green fatigue uniform, led the entire Cuban delegation to the skyscraper Secretariat building at Forty-second Street and First Avenue shortly after 7 P. M.

The Premier and seven of his aides piled into a black Oldsmobile outside the hotel at Lexington Avenue and Thirty-seventh Street. Officers in their party ran frantically into the street to get car space while the surprised police security guard tried to maintain order.

Police cars, sirens screaming, converged on the scene from all sides and escorted the party to the United Nations.

It was the first time in more than twenty-four hours in the city that the Premier had left the third-floor hotel suite. He had so much difficulty in find-

Appears in Dining Room

With Dr. Raul Roa, Havana's Foreign Minister, and Capt. Antonio Nuñez Jiménez, director of the National Agrarian Reform Institute, Dr. Castro appeared in the hotel dining room. Two hundred newsmen, photographers and officials surrounded him at a table as he announced his decision to leave.

The Premier complained of a "climate of inhospitality" in New York, and specifically against the Shelburne management. He said the Cuban delegation had been asked to put up \$10,000 in cash to cover the cost of their twenty suites and "insurance" against possible damage.

Friday night, he said, the Cubans had managed to find \$2,000 as a deposit. They were

Continued on Page 16, Column 8

opposed to the payment demand in principle as well as being unable to raise more cash at once, he said.

Dr. Castro explained that yesterday afternoon the management declared itself ready to accept a minimum 5,000 more.

The Premier said the delegation did not have that much cash and that besides, Cuban "belong to the people" and not to the Government. He interpreted his conversation with the manager as resulting in a request for the Cubans to leave.

The Premier and his associates were bitter also about the tight guard placed on them and about an incident Sunday evening in which they said the Premier had been physically molested by a security official.

Suggests U. N. Move

Dr. Castro said that if the United States could not provide normal hospitality for statesmen coming to the United Nations, then the United Nations should move to another country.

He said it was not "our fault" that the world peace agency had established headquarters in New York. He said any statesman was able to go to Havana and "be guaranteed the utmost courtesy from the Cuban Government and from every Cuban citizen."

The Cubans had not been able to find hotel quarters until the eve of their arrival on Sunday and then only because the State Department and the United Nations had intervened on their behalf.

Earlier yesterday the Cubans protested in writing to the United Nations against "uncivil and violent" conduct by a security officer assigned to protect Premier Castro.

Incident at Idlewild

The incident that perturbed the Castro party occurred a few minutes after they had left their plane at New York International Airport, Idlewild, Queens, Sunday afternoon.

As their car set out for Manhattan, the Cubans said, it was stalled by traffic near a crowd of Castro supporters who stood cheering behind a tall fence in an airport parking area.

The Premier, sitting in the rear of the black sedan at the right window, acknowledged the cheers by waving to the crowd of several hundred persons.

At that point, his party said, a plainclothes member of the security guard "pushed" the Premier's arm back into the car. Other policemen hastily surged toward the automobile and the trip was resumed.

Protest Sent to U. N. Chief

A formal protest against the alleged molestation of Dr. Castro was sent this morning to the office of Secretary General Dag Hammarskjöld. It was sent at Dr. Castro's instruction over the signature of Dr. Manuel Bisse y Alberni, Cuba's chief delegate to the United Nations.

Raul Roa Jr., son of Havana's Foreign Minister and a member of the Cuban delegation, called the guard's "disrespectful and discourteous" conduct "completely irregular." In answer to questions he expressed doubt that the agent had been only over-anxious in his desire to shield the leader.

If President Eisenhower had been so treated in Cuba, Señor Roa declared, he would not have been pleased, either.

The incident appeared to have sharpened the Cubans' displeasure with their treatment in New York. They are plainly hurt by the difficulties they encountered in finding hotel accommodations. And they resent their confinement to Manhattan by the State Department, also on the grounds of security.

C

NY Times
9-20-60

b3
b6
b7C
b7E

SEARCHED	INDEXED
SERIALIZED	FILED
SEP 19 1960	
FBI - WASH. F.	

CUBANS CAUTIOUS ON ISSUES AT U. N.

Refuses to Applaud Address by Eisenhower — But He Offers Salute to Tito

By MAX FRANKEL

Fidel Castro watched the start of diplomatic activity at the United Nations with great interest yesterday and came away determined to take it easy.

The Cuban Premier said after President Eisenhower's address that he was determined not to say anything that might further exacerbate his relations with the United States.

Dr. Castro refused to comment on the President's address until he said he could study it in detail. He spoke understandingly of New York's police force and said he would refrain from speaking publicly in Harlem to avoid accusations that he was interfering in United States internal affairs. Even in discussing his hotel difficulties here, Dr. Castro declined an invitation to state that the United Nations should be removed out of New York. He attributed his troubles to adverse "propaganda" and invited Americans to visit Cuba to "see the truth for themselves."

After experiencing difficulty in acquiring New York accommodations, the Cubans abandoned their suites at the Shelburne Hotel, Lexington Avenue and Thirty-seventh Street, protesting demands for cash. They moved Monday night to the Theresa Hotel, 125th Street and Seventh Avenue.

First In and Last Out

The bearded, 34-year-old Premier still in his ruffled fatigue uniform was the first of the most publicized dignitaries to reach the world headquarters. He led his delegation into the General Assembly hall at 10 A. M. He was the last to leave at 2:15 P. M.

Dr. Castro clapped his hands rarely a few times as President Eisenhower walked to the rostrum. But all the Cubans like the Yugoslavs and all delegations from the Soviet bloc refused to applaud at the end of President Eisenhower's address. The Cuban Premier heard both the Eisenhower and Tito speeches in Spanish translation while jotting notes on a pad. He said he could "salute" the Yugoslav President but refused repeatedly to comment on substantive issues in advance of his own address to the Assembly next Monday.

The Cuban delegation remained in the Assembly for a half hour of the luncheon recess while Dr. Castro held an animated discussion with Chilean he called "friends." He then walked into a lounge and permitted himself to be interviewed for first time since he arrived Sunday.

Asked privately whether he liked to comment on his not having been invited to President Eisenhower's luncheon yesterday with other Latin-American delegates, Dr. Castro replied quietly and with apparent embarrassment that he wanted to say nothing that would make matters worse.

Belongs to the 'Humble'

Minutes later, to a knot of newsmen, he said to the same question:

"We are not sad. We are going to take it easy. We wish them a good appetite. I will be honored to lunch with the poor and humble people of Harlem. I belong to the poor, humble people."

Within an hour, the Castro party returned to the Theresa to dramatize the Premier's comment. A dozen Negro employes of the hotel were invited to a steak luncheon with Dr. Castro.

Directs Inquiries to President

While the steaks went cold and the beer went tepid, the Premier answered for the questions of newsmen. There and in his earlier remarks, the Premier made these points in halting English:

Questions about an improvement in relations between Havana and Washington should be addressed to President Eisenhower.

Premier Khrushchey has set no definite time for his planned visit to Cuba.

It is impossible to take a leisurely stroll in New York because of the tight police guard, but the police are "only doing their duty."

The Premier said that it was "sad" and that he was "sorry" that a 9-year-old girl had been killed in a clash involving Cubans in a West Side restaurant Wednesday. But he said he is certain that "enemies" and not pro-Castro men fired the shots. "The men who fired had killed 20,000 Cubans and then were welcomed into the United States," he said. "This proves that admitting Cuban war criminals is wrong."

The Cuban leaders associate with Communists, he said, "because they want to shake hands." Other nations should be asked "why don't they want to shake hands," he declared.

Asked about the view of some Americans that Cuba was under Communist domination, Dr. Castro said this was a matter for United States intelligence agencies. "Everyone, including spies, is welcome to Cuba to see what is happening," he said.

*N.Y. Times
9/23/60*

b3
b6
b7C
b7E

Castro's Hotel Decision Apparently Not Sudden

NEW YORK, Sept. 21 (AP)—Cuban Prime Minister Fidel Castro apparently wanted to stay at the Hotel Theresa, in the Harlem Negro section right from the start.

But, according to persons involved in the situation, Mr. Castro and his 80-member party couldn't get immediate reservations there and took quarters, at the Hotel Shelburne Sunday night.

On Monday night, Mr. Castro angrily stalked out of the Shelburne and went to the United Nations to protest against what he termed high room rates. During the night he switched to the Theresa.

However, the switch reportedly boosted the Cubans' hotel bill from \$400 to \$800 a day because they took more rooms in the Theresa than in the Shelburne.

"Purely Propaganda"

Shelburne owner Edward Spatz called the move "purely propaganda" and a prearranged stunt. He originally had refused to take in Mr. Castro as a guest, but bowed to a State Department request.

An offer of free accommodations at the Commodore Hotel was brushed aside by the Cubans amid the furore.

Security agents checked the

Theresa long before Mr. Castro's arrival here Sunday. Aides of the Prime Minister said yesterday that an effort was made Saturday to obtain reservations but that the hotel was unable to accommodate the party at first.

Love B. Woods, operator of the Theresa, said definite arrangements for the transfer from the Shelburne were made at 5 p.m. Monday—two hours before Mr. Castro stormed into the U. N.

Mr. Woods said he couldn't remember whether it was Saturday or Sunday when members of the Castro group told him the switch was planned.

Noise Up Early Today

In any case, it appears that the Theresa's new guests don't like to get up early.

Up to 9 a.m. today, not a single one of them was seen stirring around the Theresa. It was pretty much the same way yesterday.

All was quiet then outside the hotel, as well as inside. There were no spectators and no demonstrators.

There were plenty of police, however. The guard force included 253 uniformed officers and an undisclosed number of detectives in the area.

Precautions included the posting of patrolmen on roof tops of buildings across the street from the hotel.

Raul Roa, jr., son of the Cuban Foreign Minister, told newsmen last night that Premier Castro planned to remain inside the hotel all day today.

Yesterday, he went to the afternoon session of the U. N. General Assembly.

b3
b6
b7C
b7E

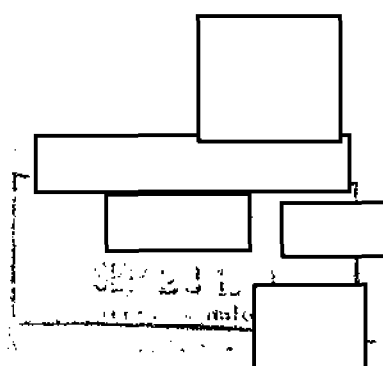

C

A-4



Cuban Prime Minister Fidel Castro (background) momentarily takes the spotlight away from Soviet Premier Khrushchev (seated, foreground) today at the United Nations in New York as he meets President Tito of Yugoslavia.—AP Wirephoto.

[Redacted]

[Redacted]

INDEXED

SEP 23 1960

WASHINGTON

[Redacted]

b3
b6
b7C
b7E

Guests at Castro Party Yield 2 Knives and Gun

NEW YORK, Sept. 23 (AP). — Police have confiscated two knives and a gun from among 250 persons attending a party for Cuban Prime Minister Fidel Castro at his Harlem hotel.

And repercussions continued from the slaying of a Venezuelan child, innocently caught in a battle between rival Cuban groups in a restaurant.

At a party in the Hotel Theresa last night, detectives found the weapons as they frisked persons entering the 11th floor Skylight Room. The gun was carried by one of Mr. Castro's guards. For future reference, police photos were taken of all guests.

Otherwise it was a peaceful affair. An organization called the Fair Play for Cuba Committee presented Mr. Castro with a bust of Abraham Lincoln. Committee President Richard Gibson said:

"Lincoln was a great liberator and Castro is a great Cuban liberator."

Negro Poet Attends

Among the guests were Negro poet Langston Hughes and French photographer Henri Cartier-Bresson.

Outside the hotel, Communist Party members distributed leaflets entitled, "Harlem Moves for Freedom," to a crowd estimated at 2,000.

Earlier in the day, Mr. Castro denounced as "lies" newspaper accounts of how 9-year-old Magdalena Urdaneto was fatally wounded by a stray bullet Wednesday in a West Side restaurant.

The girl, visiting here with her parents from Caracas, was shot in the back. She died yesterday morning in a hospital.

Police said the fight was touched off, and the shots fired, by Castro sympathizers who spotted anti-Castro men in the restaurant. A pro-Castro man was shot in the shoulder and anti-Castroites were beaten.

In Havana, government-controlled newspapers claimed the restaurant invaders were members of the anti-Castro "White Rose" organization.

Mr. Castro also blamed the shooting on enemies of his regime saying:

"Sad. They printed lies in the newspapers. The men who made the fire (fired the shots) were the same men who killed 20,000 Cubans and were welcomed to the United States. The United States welcomes all kinds of war criminals. This is the consequence."

In Washington, the State

Department expressed regret and deep sympathy to the girl's parents and to the Venezuelan government. Press Officer Lincoln White called the child a victim of "an aggressive attack by adherents of the Fidel Castro regime," adding:

"This kind of criminal activity that resulted in the ruthless slaying of this innocent bystander will undoubtedly shock people throughout the free world."

It was a fairly quiet day on the picketing and demonstration front.

Pickets Fenced In

Pickets at the United Nations building were confined to eight corral-like enclosures.

At the Soviet mansion on Park avenue, where Premier Khrushchev is staying, no pickets appeared during the day.

Last night, however, about 75 demonstrators marched in orderly fashion along East Sixty-eighth street near his headquarters.

At Mr. Castro's hotel, there were plenty of police but no pickets.

Several groups of pickets yesterday drove past Communist mission residences, producing signs reading "drop dead, you bum" and other epithets.

Mr. Khrushchev got a loud round of boos from about 3,000 persons last night outside the fashionable Plaza Hotel as he arrived for a reception given by the Togo delegation to the U.N.

Inside the Plaza, many guests, including some elderly and well-dressed women, loudly booed the Soviet Premier.

Premier Replies: 'Boo'

As he was about to enter the elevator, Mr. Khrushchev turned abruptly toward his hecklers and replied: "Boo!"

An hour later when Mr. Khrushchev emerged from the reception, he was booed and hissed again. He muttered the

NEW YORK STATE
A-8 9-23-60

b3
b6
b7C
b7E

SEARCHED	INDEXED
SERIALIZED	FILED
SEP 26 1960	

Asked Premier, Castro Says

NEW YORK, Sept. 23 (AP). —Cuban Prime Minister Fidel Castro says he has invited Soviet Premier Khrushchev to visit Cuba and Mr. Khrushchev has accepted.

The Cuban said the time of the visit still was not certain.

Mr. Castro spoke with reporters as he ate a steak yesterday in the dining room of the Theresa Hotel, a Harlem hotel in which he is making his quarters while here for the United Nations meeting.

Asked whether Cuba was dominated by Communists, Mr. Castro smiled and said:

"That's a matter for your Central Intelligence Agency to determine. If you want to know about Cuba, go there. Everybody is free in Cuba to come and go as they wish, including spies and newspapermen."

Among those present during the informal news conference was Mario Biasetti, a CBS newsreel cameraman who was ousted from Cuba several months ago without any reason being given.

Mr. Castro appeared indifferent at not being invited to a Waldorf-Astoria Hotel luncheon that President Eisenhower gave for representatives of 18 Latin American countries.

As the Cuban left the U. N. headquarters after the General Assembly session for the Theresa, he remarked:

"We take it easy. We are not sad. We wish them good appetite. We are happy eating with the poor people, the humble people of Harlem."

He declined to comment on Mr. Eisenhower's speech in the General Assembly, but said he was going to give it very careful study.

To a question whether he had gone to Harlem to woo Negro sympathy for his regime, Mr. Castro said he had not.

"Before coming here," he said, "we had the sympathy of the colored people of the United States. In Cuba we fight segregation and we had that feeling before we came here."

A-52 9-23-60

[Redacted]	
[Redacted]	INDEX
SEP 26 1960	
[Redacted]	[Redacted]
[Redacted]	[Redacted]

b3
b6
b7C
b7E

CHILD, 9, FIRST UN FATALITY

Harlem Castro Strife ³ Halts After Girl Dies

NEW YORK, Sept. 22 (UPI)—Comparative quiet returned, perhaps temporarily early today to the heart of Harlem where police spent frenzied hours keeping under control the thousands of persons milling outside Cuban Premier Fidel Castro's hotel headquarters.

Exhausted Castro demonstrators and spectators began dispersing shortly after midnight. Police had kept them out of the immediate vicinity of the Hotel Theresa where Castro has remained since attending the United Nations General Assembly session Tuesday afternoon.

The evening was marked by a series of disturbances which kept police flying squads and mounted patrolmen busy.

A child too young to know anything about politics or ideologies died early today because she was caught in the middle of a raging battle between Castro's followers and enemies.

Magdalena Urdaneta, 9, shot in the back yesterday when 14 pro-Castroites attacked five anti-Castro demonstrators in a West Side Bar, died in St. Clare's Hospital—the first death resulting from demonstrations in connection with the General Assembly session. The girl was having dinner in the bar with her parents.

An anticipated clash between pro and anti-Castro groups outside the Hotel Theresa failed to develop last night, altho police reinforcements were rushed to the area in three buses. Several persons received minor injuries and several demonstrators were arrested during the evening, however. A patron of a West Side tavern, Louis Rodriguez, 23, was wounded in the shoulder.

At one time part of 125th st, Harlem's main stem, was jammed with demonstrators

and spectators. Police estimated the crowd at between 4000 and 5000.

A white woman walking her dog was knocked down and run over when police dispersed one group protesting the arrest of a Negro demonstrator.

Meanwhile, the State Department in Washington said it would intervene in court on Cuba's behalf to prevent attachment of a Cuban airplane seized in New York if the Castro regime requested help.

Department spokesman Joseph W. Reap said the Cuban Embassy was informed that the plane, used to fly Castro and his aides from Havana to the United Nations, had a status of "sovereign immunity" by virtue of being "sovereign property on government business."

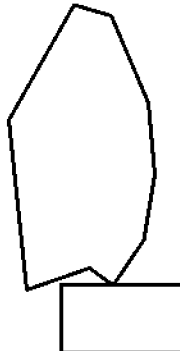

[Redacted]			
SEARCHED	[]	INDEXED	[]
SERIALIZED	[]	FILED	[]
SEP 23 1960			
FBI - WASHINGTON			
[]	[]	[]	[]
[Redacted]			

b3
b6
b7C
b7E

GIRL SHOT IN FRAY OF CUBANS IS DEAD

Venezuelan, 9, Succumbs to
Wound Received in Clash
of Partisans in Cafe

A 9-year-old girl shot during a fight Wednesday between supporters and foes of Premier Fidel Castro died yesterday.

The police pressed a search for a one-armed pro-Castro Cuban believed to have fired the fatal shot.

The girl, Magdalena Urdaneta of Caracas, Venezuela, was the innocent victim of the political unrest stirred up here as a result of the arrival of heads of government to attend the United Nations General Assembly.

She was struck by a stray bullet fired in a Latin American restaurant Wednesday afternoon. A group of supporters of the Cuban Premier had invaded El Prado restaurant, at 854 Eighth Avenue just north of Fifty-first Street, and had attacked five anti-Castro Cubans.

The girl had been lunching in the restaurant with her parents, Rafael and Nieves Urdaneta, and her younger sister, Virginia, 5. The Urdanetas were here as tourists.

Shot in the back, Magdalena was taken to St. Clare's Hospital for an emergency operation. Her condition had been reported as fair, but later she weakened. She died at 6 A. M.

About four hours earlier the police arrested Santiago Larroque, 28, of 25-01 Forty-third Avenue, Long Island City, Queens, as one of the ten men who had invaded El Prado.

Larroque admitted being one of the attackers, the police said, but denied any part in the shooting. He was charged with felonious assault and held in \$25,000 bail for a hearing Oct. 6.

Meanwhile, detectives under Assistant Chief Inspector Edward W. Byrnes, hunted for Francisco Molina, 34, nicknamed "The Hook" and known also as Panchito, a diminutive for Francisco. He was believed to have fired the pistol shots that wounded the Urdaneta girl and one of the five anti-Castro men.

Molina was described as lacking a right arm in place of which he might be wearing a hook or an artificial arm and hand. He was said to be 5 feet 10 inches tall and to weigh 180 pounds.

The police were also looking for a man who wore a beret with "July 26" the name of the Castro revolutionary movement on it. He was described as being about 30, 6 feet tall and having a thin black moustache.

Joseph Prieto, owner of the restaurant, said that Molina was a frequent visitor and that a brother, Felix, worked there as a waiter.

Mr. Prieto, who came here from Cuba eleven years ago, said that three months ago he insisted that customers desist from discussing politics in his place because of the numerous arguments about the Castro regime.

The restaurant, dimly lighted, has a front room and a back room divided by an archway. The five anti-Castro men had been sitting at a combination lunch counter and bar in the front when the Fidelistas walked in.

The fight erupted with the wielding of sticks, fists, sugar bowls and a chair and ended with the firing of several shots.

The Urdaneta family made plans to fly back to Caracas today with the body of their daughter, according to the Venezuelan vice consul, Robert Vincentelli. Señor Urdaneta, who speaks no English, is a business man.

The anti-Castro Cuban Democratic Revolutionary Front, which has an office at 1650 Broadway, issued a statement deploring the shooting and describing the Urdaneta girl as "the innocent victim of a blood-thirsty tyrant, Castro."

In Washington, Lincoln White, the State Department's press officer, expressed the department's "sympathy and regret" over the girl's death.

*N.Y. Times
9/23/60*

SEARCHED	INDEXED
SERIALIZED	FILED
SEP 23 1960	
FBI - WASHINGTON	

b3
b6
b7C
b7E

THE WASHINGTON DAILY NEWS, FRIDAY



U. S. Negroes Aren't Falling for Castro

By VIRGINIA PREWETT

Fidel Castro's grandstand play embracing Russia's Khrushchev in Harlem is recruiting few outside a tiny colored hate group who call themselves Moslems, say both local and national colored leaders.

James Hicks, editor of New York's largest colored newspaper, the weekly Amsterdam News, says, the gesture won't influence one U. S. voter or one African-UN delegate to change his position.

POSE

Mr. Hicks, whose paper scooped the world with Castro's first interview while here, told me his reporter got it by posing, at first, as a "Moslem."

"We let Castro speak his piece in the interview, and we're playing it like any big news story dumped in our laps," he said. His editorial view is that "Harlem should treat Castro like any paying guest, with dignity."

"The American Negro is politically sophisticated today," he added. "He took a look at communism in the depression when he was hungry and rejected it. That still holds true."

George Brown, editor of Harlem's second weekly, the New York Courier, said Harlem isn't profoundly moved by Castro.

"Castro and Khrushchev achieved no great victory in this community," he said. "We're Americans, too, you know." His paper is playing the story straight.

Ralph Matthews, the editor of a new extremist weekly the Citizen Call, said, thru a third person, that he was "reluctant to cooperate with a white reporter."

"Some people in Harlem are bound to look on Castro with favor," was his message. "We do, since it's our business to give the white majority hell."

VULNERABLE

The Amsterdam News' Editor Hicks noted that Castro's Harlem campaign means to "needle the U. S." on race relations and says it points up our vulnerability. Even Harlem was surprised, he reports, when a recent "Moslem" public meeting drew 10,000 people.

The leader of one of this country's largest and most respected national Negro organizations described the Moslems thus:

"They're screwballs, racketeers in race hatred. They're the kind who naturally would rally to Castro, or any disruptive influence."

His information officer, after extensive personal observations thru Harlem, says there is a surface excitement over the idea that the "world's movers and shakers" are there. But it doesn't mean that Castro is establishing influence, he said.

Other informed opinions

confirm Castro's success with the violence-prone Moslems and his lack of it with the vast majority of the Harlem community. He has, however, brought up heavy reinforcements in the person of His Negro army chief of staff, Maj. Juan Almeida. His campaign among American Negroes is just beginning.

SEARCHED [] INDEXED []
 SERIALIZED [] FILED []
 SEP 28 1961
 FBI - WASH. D. C.

b3
b6
b7C
b7E



A Drop of Poison in the Vein

By VIRGINIA PREWETT

The Harlem's leaders have not been bowled over by Fidel Castro's dramatics in establishing his headquarters there, Castro has scored. And neither Harlem nor the American Negro's struggle upward in the social and economic scale will ever be quite the same

again.

Harlem leadership has many reasons for rejecting Castro's propaganda bait. First, they report that most Latin Americans even of their own color try desperately to identify with Hispanic New York, repudiating Harlem. Also, Harlem leaders see New York's Latin American community rivaling their bid for power as a voting bloc.

Finally, Castro is linked to communism, which the American Negro rejects mainly on religious grounds.

VIOLENCE

Fidel Castro, however, is not in Harlem to peddle communism per se. His wares are disruption, and he's finding salesmen.

The first crowds that hung around the Hotel Theresa to see Fidel were laughing, curious, ignorant of what he stood for. His agents got to work, goon-squad violence flared against anti-Fidelists, claquees appeared chanting "Fidel! Fidel!" — and the atmosphere changed. Soon an afternoon paper reported 3000 people around the Theresa, the police estimated half that many. That evening even anti-Castro leaders were saying in anxious tones that 5000 people were shouting for Fidel.

This is the echo technique, used so successfully elsewhere by Castro, Hitler and Peron. It set going a different kind of thrill in Harlem, specifically among the now swaggering race racketeers who have flocked to Castro's side.

SPLINTER GROUP

The apparatus Castro has laid hand on, the so-called Black Muslims, are the Mau Mau of the American Negro world, a splinter group of escapers from the restraining effect of the Christian religion.

Castro is encouraging dignifying, and inciting this lunatic fringe, who will, in turn inflame white savagery. The Black Muslims are already reported preying on Harlem's respectable merchants to finance expanded activities.

Castro's American cohorts don't need large numbers for their mischief. Flying squads can hit, say, Birmingham, Ala., or Chicago, Ill., sov.vic-

lence with violence — and vanish like smoke, leaving both the responsible Negroes and the responsible whites crippled and embittered.

Castro an adept at propaganda techniques, knows you do not have to bath a whole body in poison to cause convulsions. A droplet let into the right vein can do it. Castro's Harlem adventure has opened such a vein.

[Redacted]

[Redacted]

SEP 28 1960

[Redacted]

b3
b6
b7C
b7E

Castro's Long Tirade Seen Reducing Stature

By WILLIAM L. RYAN
Associated Press News Analyst

UNITED NATIONS, N. Y., Sept. 28.—Fidel Castro goes home today and so far as his reputation as a statesman is concerned, he should have stayed in Havana.

He may still be a hero to his revolutionary cohorts at home, but in the eyes of many delegates to the 96-member United Nations General Assembly, Mr. Castro is leaving this country a somewhat battered warrior.

The United States did well by itself last night. To Mr. Castro's interminable tirade of almost five hours, in which he accused the United States of responsibility for every war Cuba ever suffered, United States Ambassador James J. Wadsworth gave a deliberately soft, calm reply.

That reply gave the representatives of the world's nations the impression of an understanding, tolerant uncle soothing a spoiled child.

Seen Missing Goal

Mr. Castro came off second best, by all odds. Nobody doubts that the bearded Premier came to New York with the intention of doing as much damage as possible to the United States. He missed his goal by a wide margin.

U. N. delegates assessing the impact of the Cuban Prime Minister's debut before the world organization, indicated they thought Mr. Castro might even have created sympathy for the United States where little sympathy had existed before.

It usually is not difficult for a Latin-American speaker to win an attentive audience with an attack on the United States. Among the neighbors to the South there frequently is a certain amount of secret or even open satisfaction in watching rich Uncle Sam take it on the chin from one of his

... This latent anti-Franklin feeling has been Mr. Castro's political capital in Latin America, where he still charms many among the masses and raises

INTERPRETIVE REPORT

... hopes among those of the extreme left. But he has frightened many, too, among them the men who at the present time are running Latin America's other governments and domestic affairs. He deepened their fright with his U. N. appearance.

Mr. Castro's speech obviously failed to arouse enthusiasm for his violent themes among Latin American delegations. Only the Communists, cheerfully led by Soviet Premier Khrushchev, and an isolated few others joined in bursts of applause for the Cuban's meandering, scatter-shot attack.

Delegates of young African nations, with a sort of fascination, looked on amazed while Mr. Castro spoke, following his gestures and facial expressions with an attitude of astonishment.

Possibly some of them had been measuring the young Cuban as a possible Western Hemisphere ally for the notion of a buffer bloc between the great forces of communism and the Western alliance. Anxious young African leaders want their countries' neutrality respected and guarded.

Interest Declines

What they heard, however, was the speech of a man already committed to the Communist bloc. Their interest in Mr. Castro as a potential neutralist seemed to fade.

... During the luncheon would be most feel a sense of shock among them at the burlesque appearance and approach of a man purporting to be a statesman.

The U. N. is a solemn assemblage. Many of its delegates believe deeply in their mission to create a peaceful world.

Mr. Castro took to the platform in shirtsleeves, the collar of his familiar fatigues uniform open.

Uses Up Time

He gave the delegates the impression that not even the grave-business of seeking peace in the world could interrupt his determined posturing.

They listened to him ramble hour after hour, using up time which had been previously allocated to more important affairs. It is extremely unlikely he appeared to many in the light of a responsible leader.

How Mr. Castro looked to the Communists is not important. Whatever Mr. Khrushchev and the Communists think of him in private, they will glorify him publicly as a hero. For the Communists, Mr. Castro is a satisfactorily usable young man. That is all that counts to them.

SEP 29 1960
FBI - WASH. F. O.

b3
b6
b7C
b7E

'ANTI-YANKEE, GO HOME' Fidel Lays an Egg in Harlem

By ANDREW TULLY
Special Staff Writer
NEW YORK, Sept. 28
—Dignity is not an exclusive chattel of people who live in penthouses and amid the wide green lawns of Westchester County.

It lives also and is fiercely cherished in an often misunderstood community called Harlem. And because of this, Fidel Castro's latest bit of racist grandstanding has failed.

Fidel Castro will be back in Havana this afternoon and except for those noisy, organized claquees of professional sympathizers, most of Harlem is glad to be rid of him.

This man-of-the-people bit did not impress a community irritable accustomed to political pats on the head.

Castro, convinced his indictment of the U. S. had a profound effect on the United Nations, will be greeted at the Presidential Palace in Havana tonight by a gathering of workers. He is expected to address the throng from the balcony.

IMPATIENCE

Moving up and down Seventh-av and visiting in the bars and shops of 124th and 125 streets, it is easy to sense the impatience of ordinary Harlem folks with this grandstander. Most of these people are not interested in making news, but enough were willing to pin their names to their comments to reveal the honest depth of this impatience.

Mrs. Cuthbert Wilson is a short and round woman with steel-rimmed glasses and a Bible in her large, basket-like handbag. "I don't need Fidel Castro coming here to take care of me," she said. "He's a white man trying to make trouble by conning up to us for some political reason. I don't know about him being a communist, but I'm an American citizen and I believe in God. They tell me he's against churches."

LIKES A FOSS

There is, too, Samuel Jenkins, who was sipping a beer in the Capitol Bar, catty-corner from the Theresa. "I never paid him any attention," said Jenkins. "I'm church-going people. He just likes to make a fuss. It'll be quiet again with him gone."

There is William Orcutt, encountered buying a newspaper on 124th street. "I don't see why I should bother with him," he said. "He acts like he hates the United States." And there is Fred Delaney, a machinist on a night shift. "Those Cubans are all too noisy," said Delaney. "They should have stayed downtown. We got enough troubles up here."

Another dozen talked the same language but didn't want to give their names. Their attitude was that someone had tried to use them. And, without being violent about it, they resent it.

MISTAKE

It is possible Fidel Castro made the same mistake many uninformed Americans make about Harlem. Harlem is, indeed, an enclave for the Negro. But except for the color

of their skins the people of Harlem are little different from those who live in the other little communities which make up New York City.

They are interested in making a living and caring for their children and having a little fun. They don't want to be symbols of anything and they don't want to be exploited—least of all by a forger with a beard who is feuding with their government.

As Sam Jenkins put it, "that Castro's got a nerve thinking just because we're Negroes we're disloyal to our country."

Guantanamo Reports Air Incident

HAVANA, Sept. 28 (UPI)

—A Cuban fighter plane "circled close to" two U. S. Navy planes in separate incidents off Cuba's eastern tip Sunday, it was reported today.

The American planes were operating near the big U. S. naval base outside Guantanamo which Premier Fidel Castro says Cuba may try to take back from the United States. In Washington, a Navy spokesman said reported several similar incidents near Guantanamo in the past week.

In another incident, Ambassador Philip Bonsai delivered a new note to the Foreign Office yesterday protesting the recent arrest of an embassy employe and demanding assurances there would be no further such arrests.

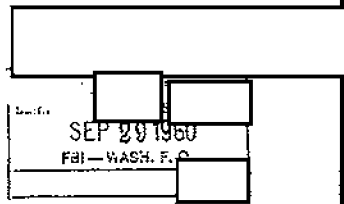

b3
b6
b7C
b7E

DALEY NEWS WEDNESDAY, SEPTEMBER 28, 1960 - 53

U. S. Defends Sugar Imports From Trujillo

The State Department replied the declaration did not include economic boycott. The declaration did call for study, not yet begun, by the Organization of American States (OAS) of possible economic sanctions. (UPI)

The United States responding to complaints from Venezuela, has denied it is violating international agreements by permitting sugar imports from the Dominican Republic.

The Agriculture Department's announcement last week that Dominican sugar could be imported, approximately at world prices, brought sharp criticism from the press in Venezuela. There were charges the action violated the Declaration of San Jose, signed last August by hemisphere foreign ministers meeting in Costa Rica.

SEARCHED	INDEXED
SERIALIZED	FILED
SEP 29 1960	
FBI - WASH. D. C.	

b3
b6
b7C
b7E



—UPI Telephoto.
Prime Minister Jawaharlal Nehru (right) of India, and India's Foreign Minister Kristina Menon, left, are shown with Fidel Castro after visiting the Cuban at the Hotel Theresa. Later, Mr. Nehru entertained Castro and Nikita Khrushchev at a dinner and, surprisingly, Castro and Nikita stayed out of the limelight.

WEST WINS 1ST ROUND AT UN
Khrushchev Primed
for Further Attacks

b3
b6
b7C
b7E

SEARCHED	INDEXED
SERIALIZED	FILED
SEP 29 1960	
FBI - WASHINGTON, D. C.	

Castro Returns Home in Plane Borrowed From Soviet Union

NEW YORK, Sept. 28 (UPI)—Cuban Premier Fidel Castro flew defiantly home in a borrowed Soviet airliner today after warning that he will return shortly and defending his Cuban regime as being based on the precepts of Abraham Lincoln.

Castro revealed his intention to pay a quick visit to make further use of the U. N. General Assembly forum apparently without realizing his Harlem hotel has no intention of admitting the Cuban envoy a second time.

Castro had been rebuffed in a maneuver to take Soviet Premier Nikita S. Khrushchev to Cuba along with him. Instead Khrushchev lent the Cuban Premier a Soviet airliner.

Three of Cuba's government airlines planes had been impounded by American creditors.

Thirty-one hopping mad members of Castro's delegation—and much of Castro's baggage—were left stranded when police refused to let one of the planes take off.

But it appeared later tonight that the Cubans might be on their way Thursday

after the United States delegation to the United Nations said it would argue in court in the morning that the plane had "sovereign immunity" and should be allowed to leave.

"The Soviets are our friends," Castro said just before departing. "Here in the United States, the authorities rob our planes."

Castro said his Cuban regime was "by the humble people, of the humble people and for the humble people—you know, just like Lincoln."

Although he called on the Great Emancipator for a comparison, it was made clear by the manager of the Hotel Theresa in Harlem that Castro would not be welcome back at his inn.

Eloye B. Woods, manager of the Theresa, said Castro and his 80-member troop would not be accepted again unless he was "forced" to give them accommodations by U. S. Government request.

Castro had worn his welcome thin in other places, and the report to police by the State Department that he would return in a week or 10 days sent up a massive groan. After stalking out of a mid-

town hotel, shortly after his arrival a week ago last Sunday, he went to the Hotel Theresa in New York's Negro section of Harlem. He said he felt at home in humble surroundings.

2 Bombs Explode As Castro Talks

HAVANA, Sept. 28 (UPI)—Two bombs exploded near the presidential palace tonight while Premier Fidel Castro was denouncing United States "imperialism" in a speech to 150,000 persons on his return from the U. N. General Assembly in New York.

Castro blamed the bombings on the United States.

The bombs apparently were small types designed to produce a loud noise. There were no injuries.

After the first explosion, Castro told the crowd: "Everybody knows who paid for that bomb. Those are the bombs of imperialism."

Castro announced that a "big brother" type of vigilance committee would be established in every block so that the activities of all residents could be checked.

SEARCHED	INDEXED
SERIALIZED	FILED
SEP 30 1960	
FBI - [redacted]	

b3
b6
b7C
b7E

DIPLOMATS STUDY HIS TIES TO SOVIET

Associates Suggest Premier Is Working on Speech Slated for Monday

By MAX FRANKEL

Ridel Castro withdrew from the limelight yesterday as the Cuban delegation to the United Nations split into two teams. The 34-year-old Premier remained closeted in his Harlem hotel with his young, bearded and uniformed associates of the Cuban revolutionary army. Older, clean-shaven men in conservative business suits, led by Foreign Minister Raul Roa, looked after Cuban interests at the world headquarters.

Both at the United Nations and at Dr. Castro's residence in the Theresa Hotel there were indications that the Cubans dramatized embraces with Premier Khrushchev and their move to Harlem, on Tuesday would turn out to be the basis of other developments.

Invites N. A. A. C. P. Leaders

Dr. Castro, for instance, took further steps to gain sympathy in the city's Negro community. He invited officials of the National Association for the Advancement of Colored People to visit him at the hotel. One of them, L. Joseph Overton, president of the association's New York branch, said he would call on the Premier during the night if an appointment could be confirmed.

A Cuban Negro leader, Manuel Juan Almeida, who is Chief of Staff of the Cuban Army, joined the Castro party late Tuesday night. He flew from Havana with Dr. Regino Boti, Minister of Economy. They and Capt. Antonio Nunez Jimenez, director of the National Agrarian Reform Institute, stayed with Dr. Castro all day yesterday.

Aides to the Premier suggested that he was working mainly on the speech he will deliver to the General Assembly Monday. Some diplomats at the United Nations, however, speculated that the arrival of the two additional Cuban officials could presage further discussion of economic and military aid to Cuba by Soviet bloc nations.

The New York police said they had been advised that Dr. Castro would go to lunch with President Anton Novotny of Czechoslovakia at the Czech leader's residence here. Later this advisory was canceled without explanation.

There have been persistent reports that the Cubans have received some planes and arms as well as economic aid from Czechoslovakia.

At the United Nations, meanwhile, Dr. Roa and Ambassador Manuel Bissó, Cuba's permanent representative at the world organization, listened to speeches in the Assembly hall and conferred with other delegates. The Cubans showed no surprise or concern at their omission from the guest list for a session with Latin American representatives today. They did not comment.

Opposed to Chile

Cuba was reported by other Latin American nations to be still contesting the choice of Chile to take Argentina's place on the Security Council next year. Traditionally the United Nations accepts the designations of regional blocs for their own representative.

Diplomats thought the Cubans may have gained Soviet support for the seat. Some talked of Mexico as a possible compromise, or a divided term with one year each for Chile and Cuba.

The Cubans also were reported to have approached President Tito of Yugoslavia last night. There was no word on the reason, Marshal Tito has a standing invitation to Havana and has attracted the Cubans' interest in his policy of non-alignment with military blocs.

Dr. Castro's party and the augmented 258-man police detail assigned to the Cubans appeared yesterday to have solved their housekeeping problems at the Theresa Hotel. Several times yesterday large trays of food were brought to the Cubans from outside the hotel, but they expressed satisfaction with their accommodations and the hotel's services.

Packages Screened

The police set up a routine communications center and arranged for orderly screening of incoming packages, like a case of beer and a dozen roses that arrived yesterday.

The Cuban delegation fell behind yesterday in its payment of daily rent to the Theresa's owner, Love E. Woods, but he planned no immediate action. Mr. Woods described his guests as "nice" people and said that he would be willing to accept their checks if they could not raise \$840 in cash each day for the thirty-five units they occupy.

Curious passersby congregated at the Theresa but there were no large crowds or demonstrations during the day. Shopkeepers around the hotel complained that the tight police guard had interfered with business.

N.Y.
Times
9/22/60

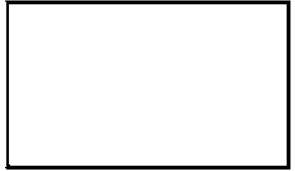

SEARCHED [] INDEXED []
SERIALIZED [] FILED []
SEP 22 1960



b3
b6
b7C
b7E

DEFECTOR TESTIFIES ON HILL

Fidel Set to Take On All Comers—Even U. S.

A former aide of Fidel Castro says the Cuban Premier once told his top followers that it might become necessary to fight the United States.

This was the sworn testimony of Capt. Manuel Rojo Del Rio, one-time aide to the Cuban general staff and commander of Castro's parachute troops.

Sr. Rojo, who defected from Cuba late last year, made the statement before the Senate Internal Security Subcommittee headed by Sen. James O. Eastland (D. Miss.).

The testimony, taken behind closed doors in January, was made public today.

Sr. Rojo said Castro talked of the possibility of future military action against the United States at a staff meeting in his Sierra Maestra hideaway before he overthrew the Batista regime.

"When our revolution ends," Sr. Rojo quoted Castro as telling his officers, "we shall attack the Dominican Republic. If necessary, we shall fight the U. S. A."

Sr. Rojo said he later overheard a comment by Castro's

brother Raul, which went a step beyond this.

He said Raul boasted Cuba would move against "all the dictators in Latin America and ultimately against the United States" once the Dominican Republic fell.

Sr. Rojo also claimed in his testimony that:

- Castro has "secret camps" in which guerrilla troops are being trained to foment and lead revolutions in the Dominican Republic, Nicaragua, Guatemala, Paraguay, Haiti, Panama, and even Spain.

- Castro wanted to plant a secret agent inside the FBI "to find out what was being planned against Cuba." "Children spy and inform on their families."

- Many of the top Cuban leaders are communists, including Ernesto (Che) Guevara. (UPI)

[REDACTED]	
SEARCHED [REDACTED]	INDEXED [REDACTED]
SERIALIZED [REDACTED]	FILED [REDACTED]
OCT 10 1960	
FBI — WASH. F. C.	
[REDACTED]	[REDACTED]

b3
b6
b7C
b7E

Russia Pounces on Issue in UN

Castro May Invade N. Y. Again to Push U. S. Invasion Charge

NEW YORK, N. Y., Oct. 20 (UPI)—Diplomatic sources said today Fidel Castro may fly back to the United Nations to press his charge, supported by Russia, that the United States is preparing to invade "at any moment."

The accusation, made in a memorandum to the General Assembly yesterday, appeared certain to spark a full debate.

By taking his case directly to the General Assembly instead of putting it first before the 11-member Security Council, Castro assured himself of wider audience.

Several Latin American sources said they thought Castro would leave it up to his foreign minister, Raul Roa, to present the Cuban case but others pointed out that when Castro left New

York last month he said he planned to return before the end of the session.

Russia quickly seized on the Cuban charges. Soviet Ambassador Valerian Zorin brought it into the disarmament debate yesterday, saying the Cuban complaint confirmed the United States was mistreating peace-loving states.

The Cuban memorandum did not specify just who the invaders would be — whether uniformed troops or private mercenaries acting with government support — but it directly accused the State Department, the Pentagon and "U. S. monopolies" of organizing a full scale attack.

It also accused Vice President Richard M. Nixon and Sen. John F. Kennedy of "cynically advocating aggression, intervention and subversion against the Cuban Government and people."

Hill Fears Move on Guantanamo

MIAMI BEACH, Oct. 20 (UPI)—The U. S. Ambassador to Mexico said yesterday that Cuba, on instructions from Russia and Red China, may move against the Guantanamo Naval Base to disturb this nation on the eve of its national elections.

In such an event, "the United States must defend Guantanamo base with all our strength," Ambassador

Robert C. Hill told the American Legion Convention.

Mr. Hill also accused Cuba of murdering "American boys."

"We must act strongly. We must isolate Cuba's dictatorial Red-leg regime," he said.

Mother Watched Son Condemned

MIAMI, Oct. 20 (UPI)—A mother told yesterday how she watched a Cuban military court condemn her son to a firing squad and then was denied the right to bury him. Spectators in the courtroom shouted "to the wall" and a

boy sold soft drinks while her son's fate was decided, she said.

Mrs. Jennie Jewett Fuller, 59, described the last hours of her son, Robert Fuller, 25, who was shot by a firing squad near Santiago, Cuba, last Sunday.

"Near me Cuban men and women started to chant: 'To the wall, to the wall.'"

"I stood up and stretched out my arms to a group of Cuban women nearest me and said: 'Please don't. Please don't. I'm a mother, too. One of those boys over there is my son.'"

INDEXED SERIALIZED FILED OCT 24 1960 FBI - WASH. F. O.

b3
b6
b7C
b7E

Three Alleged Attempts by Castro To Export Revolution Snuffed Out

United Press International
Central America on Monday crushed three alleged Fidel Castro attempts to "export" his Cuban revolution to his Caribbean neighbors by armed revolt.

Guatemala stamped out what it officially described as a Cuban-sponsored revolt movement in 24 hours of bitter and bloody fighting.

Nicaragua repelled invasion by armed guerilla bands in Cuban army fatigue uniforms and wearing Castro "fatherland or death" insignia in three days of combat and siege.

Costa Rica dispersed what officials said were Cuban-led and supplied armed bands seeking to use the country as a springboard for attack on Nicaragua.

Officially Denied

Cuba officially denied the charges of complicity in the revolt movement but Castro's open enmity toward the regimes involved has been long evident.

Guatemalan Foreign Affairs Minister Jesus Uda Murillo said the government has requested the United States to patrol its Caribbean shores with ships and planes to deter any invasion plans Cuba might entertain. He said both Nicaragua and Guatemala had

proof that the Cuban government had "aided and abetted" the rebels in their respective countries.

This was the three-nation situation:

Guatemala—The government announced "liquidation" of the revolt movement and filed formal charges of "complicity" against Cuba with the Organization of American States.

In Washington, the OAS Inter-American Peace Committee agreed last night during an emergency session to consider Guatemala's charges.

President Miguel Ydigoras Fuentes said documents seized from the rebels showed they had orders to capture the military airport at Puerto Barrios to enable the Castro regime to fly in reinforcements and supplies.

The plan presumably failed when the Guatemalan air force destroyed the military airport by bombing last night.

The president himself announced the end of organized hostilities and ordered the air force to cease bombing rebel positions to avoid useless bloodshed. He said there still was some "dispersed" rebel activity but it was unimportant.

President Ydigoras said rebel troops had evacuated the fixed positions they held in the northeast towns of Zacapa and Puerto Barrios and were widely spread out.

Nicaragua—Fourteen "die-hard" rebels surrendered to government troops at Diriamba, near Managua, and released unharmed 250 school children held hostage since Friday. The government guaranteed the rebels, described as "Castro mercenaries," their lives and a fair trial but rejected their demands for a safe conduct out of the country.

The rebels had stormed the

Christian Brothers school at Diriamba's outskirts at midnight Friday after being driven out of the army post they seized in the town earlier in the day. They used the school children and two captured National Guard officers, Col. Rodolfo Dorn and Capt. Bernardo Mendieta, as hostages while under siege.

The government forces allowed food and water to pass through their lines during the 60-hour siege to assure the comfort of the children.

Costa Rica—The government threw all available troops into the border fighting to kill or capture the armed rebel bands which shot and killed Civil Guard Commander Col. Jose Monge. The capture of nearly a dozen fully armed rebel guerilla fighters by Costa Rican patrols indicated the invasion force had dissipated its strength.

In Washington, State Department officials said the attempted rebellions in Nicaragua and Guatemala played into Castro's hands whether or not he helped organize them. U. S. officials expressed fear that local Communists in the two countries might capitalize on the confusion to start trouble of their own.

NOV 17 1960

b3
b6
b7C
b7E

FEDERAL BUREAU OF INVESTIGATION
FOI/PA
DELETED PAGE INFORMATION SHEET
FOI/PA# 1362425-000

Total Deleted Page(s) = 41
Page 4 ~ b3; b6; b7C; b7E;
Page 5 ~ b3; b6; b7C; b7E;
Page 6 ~ Referral/Direct;
Page 12 ~ b3; b6; b7C; b7D;
Page 13 ~ b3; b6; b7C; b7D;
Page 14 ~ b3; b6; b7C; b7D;
Page 41 ~ b3; b6; b7C; b7E;
Page 47 ~ Duplicate;
Page 50 ~ b3; b6; b7C; b7E;
Page 51 ~ b3; b6; b7C; b7E;
Page 52 ~ b3; b6; b7C; b7E;
Page 63 ~ b6; b7C; b7E;
Page 64 ~ b6; b7C; b7E;
Page 65 ~ b6; b7C; b7E;
Page 66 ~ b6; b7C; b7E;
Page 67 ~ b7E;
Page 71 ~ Duplicate;
Page 72 ~ b3; b6; b7C; b7E;
Page 73 ~ b3; b6; b7C; b7E;
Page 78 ~ Referral/Direct;
Page 79 ~ Referral/Direct;
Page 80 ~ Referral/Direct;
Page 88 ~ b3; b6; b7C; b7D;
Page 89 ~ b3; b6; b7C; b7D;
Page 91 ~ b3; b6; b7C; b7D;
Page 100 ~ Referral/Direct;
Page 101 ~ Referral/Direct;
Page 113 ~ Duplicate;
Page 114 ~ Duplicate;
Page 115 ~ Duplicate;
Page 116 ~ Duplicate;
Page 119 ~ Duplicate;
Page 120 ~ Duplicate;
Page 130 ~ b3; b6; b7C; b7D; b7E;
Page 135 ~ Duplicate;
Page 136 ~ Duplicate;
Page 137 ~ Duplicate;
Page 139 ~ b3; b6; b7C; b7D; b7E;
Page 142 ~ Duplicate;
Page 143 ~ Referral/Direct;
Page 144 ~ Referral/Direct;

XXXXXXXXXXXXXXXXXXXXXXXXXXXX
X Deleted Page(s) X
X No Duplication Fee X
X For this Page X
XXXXXXXXXXXXXXXXXXXXXXXXXXXX

~~SECRET~~

1 - [redacted]

b6
b7C

ADIC, New York

1/22/79

Director, FBI

VISIT OF FIDEL CASTRO
TO THE U.S.

u

[redacted]

Enclosed for New York and WFO is one copy each
of [redacted]

b3
b7E

Recipients should expeditiously advise FBIHQ
of any information you may receive which would indicate
that Castro does plan to attend the United Nations General
Assembly. ~~(S)~~ (U)

Enclosure

1 - WFO

[redacted]

(5)

b3
b6
b7C
b7E

NOTE:

NYO and WFO furnished [redacted]

MAILED 5

JAN 23 1979

FBI

EX-125

REC-9

185-1241-X

b3
b7E

~~SECRET MATERIAL ATTACHED~~

5 JAN 25 1979

~~SECRET~~

~~Classified and Extended by 2476
Reason for Extension FCIM II, 1-2.4.2 2
Date of Review for Declassification 1/22/99~~

- Asoc. Dir. _____
- Dep. AD Adm. _____
- Dep. AD Inv. _____
- Asst. Dir.:
- Adm. Servs. _____
- Crim. Inv. _____
- Ident. _____
- Intell. _____
- Laboratory _____
- Legal Coun. _____
- Plan. & Insp. _____
- Rec. Mgnt. _____
- Tech. Servs. _____
- Training _____
- Public Affs. Off. _____
- Telephone Rm. _____
- Director's Sec'y _____

MAIL ROOM [initials]

185-1241-27

b6
b7C

OO HQ CG LA MM NK HI WF

b6
b7C

Exec. AD-Adm.	_____
Exec. AD-Inv.	_____
Exec. AD-LES	_____
Asst. Dir.:	
Adm. Serv.	_____
Crim. Inv.	_____
Ident.	_____
Intell.	_____
Laboratory	_____
Legal Coun.	_____
Plan. & Insp.	_____
Rec. Mgnt.	_____
Tech. Servs.	_____
Training	_____
Public Affs. Off.	_____
Telephone Rm.	_____
Director's Sec'y	_____

DE NY 0043

0182239Z SEPT 79

18 SEP 79 22 57z

FM NEW YORK (185-NEW) (M-10)

FEDERAL BUREAU OF INVESTIGATION
COMMUNICATIONS SECTION

TO DIRECTOR IMMEDIATE

CHICAGO IMMEDIATE

LOS ANGELES [redacted] IMMEDIATE (VIA FBIHQ)

MIAMI [redacted] IMMEDIATE

b3
b6
b7C
b7E

/// ALL OFFICES VIA FBIHQ ///

NEWARK IMMEDIATE

SAN JUAN IMMEDIATE (VIA FBIHQ)

WASHINGTON FIELD IMMEDIATE (VIA FBIHQ)

BT

~~CONFIDENTIAL~~

PROPOSED VISIT OF CUBAN PREMIER FIDEL CASTRO TO THE UNITED STATES, OCTOBER 1979; PEO MATTER.

RECEIVED
DE-30
N 185-1241-1

RELATEL TO ALL RECIPIENTS, DATED SEPTEMBER 18, 1979,

CAPTIONED [redacted]

SI-126

b3
b7E

22 SEP 27 1979

IN VIEW OF THE GRAVITY OF THE SITUATION AS SET FORTH IN

REFERENCED LOS ANGELES TELETYPE, NEW YORK REQUESTS LOS ANGELES

TO IMMEDIATELY OBTAIN AND PROVIDE THE FOLLOWING INFORMATION:

1. WHAT TYPE OF INFORMATION HAS THE LOS ANGELES POLICE

63 OCT 19 1979

TELETYPE TO [redacted]

b6
b7C

DEPARTMENT SOURCE PROVIDED IN THE PAST WHICH ESTABLISHED HIS RELIABILITY?

2. IS THE SOURCE IN A POSITION TO OBTAIN INFORMATION SUCH AS IT WAS FURNISHED IN REFERENCED LOS ANGELES TELETYPE?

3. WHO IS THE ORIGINATOR OF THIS INFORMATION?

4. IS THE SOURCE IN A POSITION TO OBTAIN MORE SPECIFIC INFORMATION RELATIVE TO THIS PLOT?

NEW YORK RECOMMENDS THAT DISSEMINATION TO OTHER AGENCIES BE HELD IN ABEYANCE UNTIL ATTEMPTS TO CORROBORATE THIS INFORMATION ARE MADE.

RECIPIENTS REQUESTED TO IMMEDIATELY CONTACT SOURCES IN THE CUBAN EXILE COMMUNITY.

NEW YORK IS IN THE PROCESS OF DOING SAME.

~~C AND E 5815, REASON 2, DRD SEPTEMBER 18, 1999.~~

BT

#

NY0511 065000Z

PP HQ CG LA MM NH HI WF

RECEIVED
TELETYPE UNIT

DE NY 0036

27 SEP 79 02 59z

P210059Z SEPT 79

FM NEW YORK (185-) (NY-187)

RECEIVED
FEDERAL BUREAU
OF INVESTIGATION
COMMUNICATIONS SECTION

TO DIRECTOR PRIORITY

CHICAGO PRIORITY

LOS ANGELES PRIORITY

MIAMI PRIORITY

NEWARK PRIORITY

SAN JUAN (185-70) PRIORITY (VIA FRIMO)

WASHINGTON FIELD PRIORITY

BT

~~CONFIDENTIAL~~

PROPOSED VISIT OF CUBAN PREMIER FIDEL CASTRO TO THE UNITED STATES, OCTOBER 1979; PFO MATTER; OO: NEW YORK.

REFERENCE SAN JUAN IMMEDIATE TELETYPE, SEPTEMBER 21, 1979.

THE REFERENCED SAN JUAN TELETYPE ADVISED THAT SAN JUAN IS IN POSSESSION OF AN UP TO DATE PHOTO ALBUM OF CUBAN EXILE TERRORIST.

1-126

REC-124

185-1241-2

SAN JUAN IS REQUESTED TO FURNISH NYO WITH A COPY OF SAME. 16 SEP 26 1979

NEW YORK HAS ALREADY FURNISHED UNITED STATES SECRET SERVICE,

Exec. AD-Adm.	
Exec. AD-Inv.	
Exec. AD-LES	
Asst. Dir.:	
Adm. Serv.	
Crim. Inv.	
Ident.	
Intell.	
Laboratory	
Legal Coun.	
Plan. & Insp.	
Rec. Mgmt.	
Tech. Servs.	
Training	
Public Affs. Off.	
Telephone Rm.	
Director's Sec'y.	

b6
b7C

b6
b7C

b6
b7C

b6
b7C

573 OCT 19 1979

NEW YORK CITY WITH PHOTOS AND DESCRIPTIVE DATA SHEETS ON
CUBAN NATIONALIST MOVEMENT MEMBERS IN THE NEW YORK/NEW JERSEY
AREA.

IN REGARD TO SAN JUAN REQUEST, EXACT DATES OF CASTRO'S
VISIT ARE UNKNOWN BY UNITED STATES SECRET SERVICE AT THIS TIME.

ON SEPTEMBER 26, 1979, NYO SPECIAL AGENTS WILL ATTEND A
CONFERENCE REGARDING CASTRO'S VISIT. IN ATTENDANCE WILL BE
REPRESENTATIVES OF UNITED STATES SECRET SERVICE, ARSON AND
EXPLOSION SQUAD, INTELLIGENCE DIVISION, AND PRECINCT COMMAND
PERSONNEL, NEW YORK CITY POLICE DEPARTMENT. HOPEFULLY, DATES
OF THE VISIT AND PROPOSED ITINARY WILL BE AVAILABLE AT THAT
TIME.

~~C AND 7-5315, REASON 2, DED SEPTEMBER 21, 1999.~~

RECEIVED
TELETYPE UNIT

b6
b7C

26 SEP 79 17 00z

RECEIVED [redacted]
FEDERAL BUREAU
OF INVESTIGATION
COMMUNICATIONS SECTION

Exec. AD-Adm.	
Exec. AD-Inv.	
Exec. AD-LES	
Asst. Dir.:	
Adm.	
Crim.	
Ident.	
Intell.	
Laboratory	
Legal Coun.	
Plan. & Insp.	
Rec. Mgnt.	
Tech. Servs.	
Training	
Public Affs. Off.	
Telephone Rm.	
Director's Sec'y	

SJ0001 2691645Z
 OO HI LA NM NY NK WF
 OF SJ 0001
 O 261645Z SEP 79
 FM SAN JUAN
 TO DIRECTOR IMMEDIATE
 LOS ANGELES IMMEDIATE
 MIAMI IMMEDIATE
 NEW YORK IMMEDIATE
 NEWARK IMMEDIATE
 WASHINGTON FIELD IMMEDIATE

BT

~~SECRET~~

PROPOSED VISIT OF CUBAN PREMIER FIDEL CASTRO TO THE UNITED STATES, OCTOBER 5, 1979; PFC MATTER (OO: NEW YORK)

REFERENCE NEWARK TELETYPE, DATED SEPTEMBER 25, 1979;
 SAN JUAN TELETYPE, DATED SEPTEMBER 25, 1979. *cuba USA*

ON MARCH 8, 1977, [redacted] STATED THAT [redacted]

[redacted]

SI-126 185-1241-3

REC-124

22 SEP 27 1979

b6
b7C

TELETYPED TO: [redacted]
 [redacted]

TELETYPED TO:

[redacted]

b3
b6
b7C
b7D

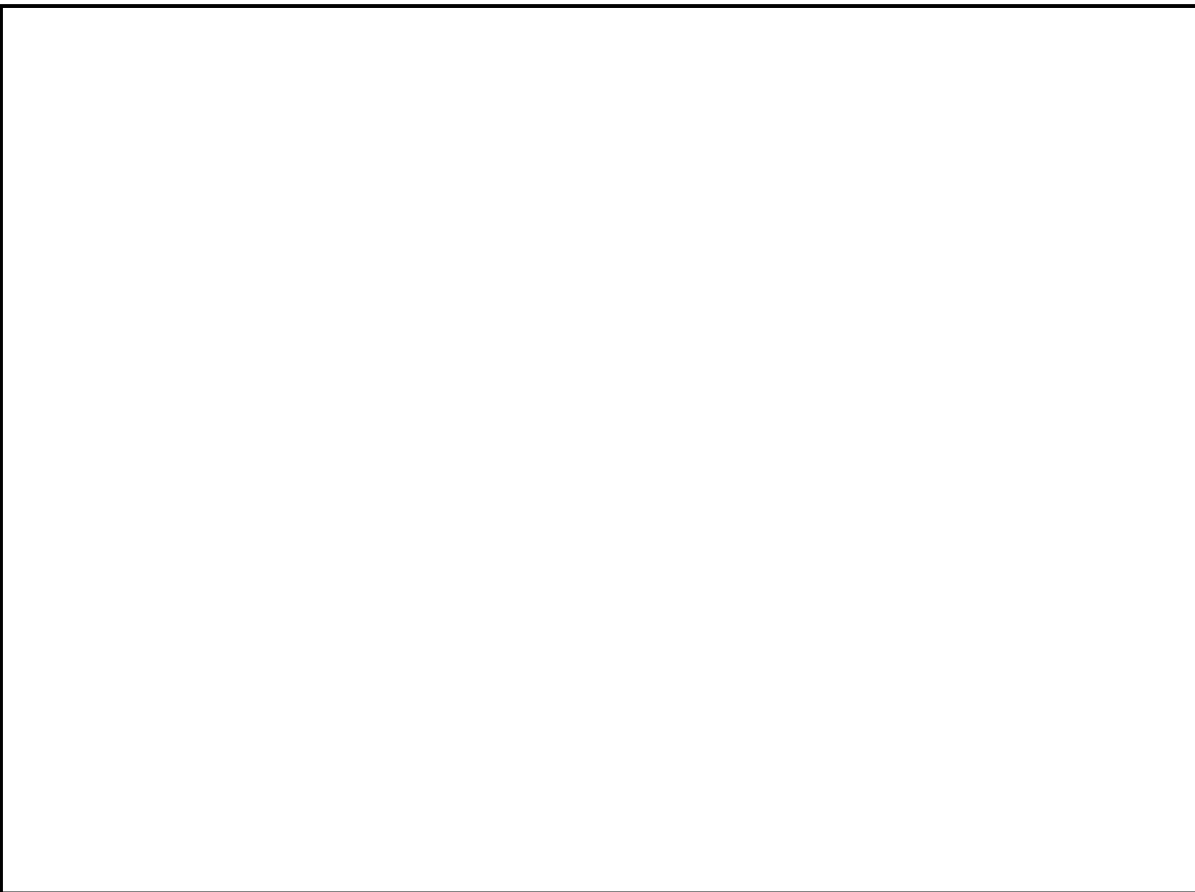

 ~~(S)~~ (U)

IN VIEW OF THE ABOVE SOURCE INFORMATION CONCERNING



b3
b6
b7C
b7D

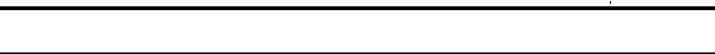

SOURCES ARE ALSO OF

PAGE SIX ~~SECRET~~

THE OPINION THAT [REDACTED]

b3
b7D

FOR ADDITIONAL INFORMATION, SAN JUAN CAN BE CONTACTED
VIA SECURE TELEPHONE NUMBER 753-4897, WHICH SHOULD BE SET IN
THE [REDACTED] WHICH IS UNIQUE TO THE SAN JUAN
SECURE TELEPHONE SYSTEM.

b7E

~~C AND E, 8024, REASON (2), DRD SEPTEMBER 26, 1999.~~

BT

b6
b7C

Exec. AD-Adm.	
Exec. AD-Inv.	
Exec. AD-LES.	
Asst. Dir.:	
Adm. Servs.	
Crim. Inv.	
Ident.	
Intell.	
Laboratory	
Legal Coun.	
Plan. & Insp.	
Rec. Mgmt.	
Tech. Servs.	
Training	
Public Affs. Off.	
Telephone Rm.	
Director's Sec'y	

NY0683 2700033

RECEIVED
TELETYPE UNIT

27 SEP 79 00 40z

RECEIVED
FEDERAL BUREAU
OF INVESTIGATION
COMMUNICATIONS SECTION

PP HQ

DE NY 0017

P262300Z SEPT 79

FM NEW YORK [redacted]

TO DIRECTOR PRIORITY

BT

~~SECRET~~

b3
b6
b7C
b7E

PROPOSED VISIT OF CUBAN PREMIER FIDEL CASTRO IN CONNECTION WITH

UNGA, OCTOBER, 1979, [redacted]

b6
b7C

ON SEPTEMBER 26, 1979, A CONFIDENTIAL SOURCE WHO HAS FURNISHED
RELIABLE INFORMATION IN THE PAST, ADVISED THAT [redacted]

[Large redacted block]

~~SECRET~~

b3
b6
b7C
b7E

[redacted]

CSX SI-126

REC-30 785-1241-4

C AND E 3441, REASON 2 AND 3, DRD SEPTEMBER 26, 1999.

11 SEP 27 1979

ADMINISTRATIVE

b6
b7C

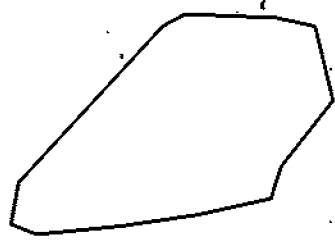

63 OCT 19 1979

28b SE 2 30 1979

INLETTERING DIV
RECEIVED

PAGE TWO ~~SECRET~~

CONFIDENTIAL SOURCE IS [REDACTED]

b3
b7E

NYO IS OF THE OPINION THAT [REDACTED]

[REDACTED]

[REDACTED]

~~(S)~~ (U)

NYO WILL BE ALERT FOR ANY INFORMATION CONFIRMING THE DATES
OF CASTRO'S VISIT TO NYC. ~~(S)~~ (U)

BT.

#

Exec. AD-Adm.	b6
Exec. AD-Inv.	b7C
Exec. AD-LES	
Asst. Dir.:	
Adm. S.	
Crim. I.	
Ident.	
Intell.	
Laboratory	
Legal Coun.	
Plan. & Insp.	
Rec. Mgnt.	
Tech. Servs.	
Training	
Public Affs. Off.	
Telephone Rm.	
Director's Sec'y	

NY0380 2622001

OO HQ CG LA MM NK SJ WF
DE NY 008

19 SEP 79 20 15z

O 191958Z SEPT 79

FEDERAL BUREAU OF INVESTIGATION
COMMUNICATIONS SECTION

FM NEW YORK (185-NEW) (M-10)

TO DIRECTOR IMMEDIATE

CHICAGO IMMEDIATE

PERSONAL ATTENTION SAC

LOS ANGELES IMMEDIATE (VIA FBIHQ)

PERSONAL ATTENTION SAC

MIAMI IMMEDIATE

PERSONAL ATTENTION SAC

NEWARK IMMEDIATE

PERSONAL ATTENTION SAC

SAN JUAN IMMEDIATE (VIA FBIHQ)

PERSONAL ATTENTION SAC

WASHINGTON FIELD IMMEDIATE (VIA FBIHQ)

PERSONAL ATTENTION SAC

BT

REC-126 185-1241-5

SEP 27 1979

~~CONFIDENTIAL~~

PROPOSED VISIT OF CUBAN PREMIER FIDEL CASTRO TO THE UNITED STATES, OCTOBER 1979; PFO MATTER; OO: NEW YORK.

NEW YORK IS MAKING NO REFERENCES TO ANY PRIOR COMMUNICATIONS

VIA: 6101
INVESTIGATIVE
DIVISION
RECEIVED

TT TO
LA, NY, CG
NJ, SJ, WFO
9-20-79

TELETYPE TO:

LA, WF, SJ
59 OCT 16 1979
254

b6
b7C

b6
b7C

b6
b7C

CONCERNING CAPTIONED MATTER AS RECIPIENTS CONTINUE TO REPORT INFORMATION RELATIVE TO POSSIBLE PLOTS AGAINST CASTRO UNDER VARIOUS AND NUMEROUS CAPTIONS.

IN VIEW OF THE FACT THAT FIDEL CASTRO'S PROPOSED VISIT WILL TAKE PLACE IN NEW YORK CITY, THE NYO IS DESIGNATING ITSELF OFFICE OF ORIGIN AND OFFICE OF ORIGIN IS SETTING FORTH THE FOLLOWING INSTRUCTIONS:

ALL RECIPIENTS WILL, IN THE FUTURE, REPORT ALL INFORMATION CONCERNING CASTRO'S VISIT IN A FORM SUITABLE FOR DISSEMINATION UNDER THE ABOVE CAPTION. THE DISSEMINATION OF INFORMATION CONCERNING ALLEGED CUBAN EXILE PLOTS WILL BE CONTROLLED BY NEW YORK. NYO SQUAD M-10 SUPERVISOR AND CASE AGENT WILL BE IN DAILY CONTACT WITH UNITED STATES SECRET SERVICE, UNITED STATES DEPARTMENT OF STATE AND THE INTELLIGENCE DIVISION, NYCPD.

RECIPIENTS ARE ADVISED THAT THE UNITED STATES SECRET SERVICE, UNITED STATES DEPARTMENT OF STATE AND INTELLIGENCE DIVISION, NYCPD, HAVE THE RESPONSIBILITY OF PROVIDING SECURITY FOR CASTRO AS WELL AS NUMEROUS OTHER FOREIGN DIGNITARIES WHO WILL ATTEND THE UNITED NATIONS GENERAL ASSEMBLY. THE

U.S. DEPT. OF JUSTICE

APR 13 4 31 PM '53

RECEIVED
COMMUNICATIONS SECTION
APR 13 1953

PAGE THREE ~~CONFIDENTIAL~~

MAGNITUDE OF SUCH A RESPONSIBILITY IS SELF EVIDENT. THEREFORE, NEW YORK DOES NOT INTEND TO DISSEMINATE UNSUBSTANTIATED ALLEGATIONS AND RUMOR. IN VIEW OF THIS RECIPIENTS ARE DIRECTED TO IMMEDIATELY ATTEMPT TO CORROBORATE THROUGH SOURCES OF PROVEN RELIABILITY AND OTHER INVESTIGATION DEEMED APPROPRIATE, ANY INFORMATION CONCERNING PLOTS AGAINST CASTRO.

SAN JUAN HAS INDICATED THAT NEW YORK HAS NOT RECEIVED ALL COMMUNICATIONS RELATIVE TO THE [REDACTED] PLOT. SAN JUAN WILL PROVIDE NEW YORK WITH A TELETYPE CAPTIONED AS ABOVE, SETTING FORTH ALL INFORMATION CONCERNING THIS PLOT REGARDLESS OF ANY PRIOR COMMUNICATIONS.

b6
b7c

ANALYSIS OF INFORMATION AVAILABLE TO NEW YORK AT THIS TIME, INDICATES THAT THE [REDACTED] PLOT AND THE [REDACTED] [REDACTED] PLOT BEAR THE MOST VALIDITY AT THIS TIME AND THEREFORE CHICAGO AND SAN JUAN WILL IMMEDIATELY PROVIDE NEW YORK WITH FURTHER DEVELOPMENTS AS THEY OCCUR.

b6
b7c

~~C AND E 5815, REASON 2, DRD SEPTEMBER 19, 1999.~~

BT

#

U.S. DEPT. OF JUSTICE
1-8-7

SEP 19 4 01 PM '79

U.S. DEPT. OF JUSTICE
RECEIVED

b6
b7C

RECEIVED
TELETYPE UNIT

24 SEP 79 20 44Z

RECEIVED
FEDERAL BUREAU
OF INVESTIGATION
COMMUNICATIONS SECTION

Exec. AD-Adm.	
Exec. AD-Inv.	
Exec. AD-LES	
Asst. Dir.:	
Adm.	
Crim.	
Ident.	
Intell.	
Labor.	
Legal	
Plan. & Insp.	
Rec. Mgnt.	
Tech. Servs.	
Training	
Public Affs. Off.	
Telephone Rm.	
Director's Sec'y	

MF

NY 29 2612335

RR HARRY
DE BK

R 24236Z SEP 79

FM NEWARK (185-122) (P) (C-3)

TO DIRECTOR [redacted] (ROUTINE)

NEW YORK (ROUTINE)

BT

DINS

27
6/14

PROPOSED VISIT OF CUBAN PREMIER FIDEL CASTRO TO THE UNITED STATES

OCTOBER, 1979.

RE MIAMI TELETYPE TO BUREAU, SEPTEMBER 20, 1979; NEWARK

TELETYPES TO BUREAU, SEPTEMBER 14 AND 17, 1979

ON SEPTEMBER 21, 1979, [redacted] ADVISED THAT [redacted]

b3
b6
b7C
b7E

b3
b6
b7C
b7D
b7E

REC 117
DET 185-1241-6

2 OCT 1 1979

UNRECORDED COPY FILED IN

b3
b6
b7C
b7E

MAILED
CUBAN
RECEIVED

[redacted]

XEROX

OCT 4 1979

64 OCT 25 1979

9/27/79

PAGE TWO, NK 185-122, ~~SECRET~~

[REDACTED]
[REDACTED] ACCORDING TO SOURCE, [REDACTED]

b6
b7C
b7D

~~C & E BY 953, REASONS (2) AND (3); DRD SEPTEMBER 24, 1999.~~

BT

148



DEPARTMENT OF JUSTICE
FEDERAL BUREAU OF INVESTIGATION
COMMUNICATION MESSAGE FORM

DECLASSIFICATION AUTHORITY DERIVED FROM:
FBI AUTOMATIC DECLASSIFICATION GUIDE
DATE 03-08-2023

b6
b7C

PAGE 1 OF 1	CLASSIFICATION SECRET	ROUTINE
DATE 9/21/79		

#F148ERR CG LA MM NK NY SJ WEDE HQ H0148 #H4YSSR 212230Z SEP 79

> START HERE

- FM DIRECTOR FBI
- TO FBI CHICAGO ROUTINE
- FBI LOS ANGELES ROUTINE
- 14 FBI MIAMI ROUTINE
- FBI NEWARK ROUTINE
- 12 FBI NEW YORK ROUTINE
- FBI WASHINGTON FIELD ROUTINE
- 10 FBI SAN JUAN ROUTINE



2

DO NOT PASTE PAST THIS LINE

BT

~~SECRET~~

PROPOSED VISIT OF CUBAN PREMIER FIDEL CASTRO TO THE U. S.,

OCTOBER, 1979; PFO MATTER; OO:NEW YORK.

RESJTEL SEPTEMBER 20, 1979. (U)

FOR INFORMATION RECIPIENTS, SECRET SERVICE WAS FURNISHED

PARAPHRASED INFORMATION FROM RETEL UNDER CAPTION OF [REDACTION]

[REDACTION] SHOULD THEY WISH TO DISCUSS

MATTER WITH YOU, NO OTHER INFORMATION SHOULD BE DISCUSSED.

DO NOT TYPE MESSAGE BELOW THIS LINE

APPROVED BY [Signature]	DRAFTED BY [REDACTION]	DATE 9/21/79	ROOM 4147/5	TELE EXT 4605
-------------------------	------------------------	--------------	-------------	---------------

- 1 - [REDACTION]
- 1 - [REDACTION]

1-1241

REC 11

185-1241-7

FEDERAL BUREAU OF INVESTIGATION
COMMUNICATIONS SECTION

SEP 22 1979

24 SEP 24 1979

b6
b7C

b6
b7C

DO NOT FILE WITHOUT COMMUNICATIONS STAMP

64 OCT 2 1979

DEPARTMENT OF JUSTICE
FEDERAL BUREAU OF INVESTIGATION
COMMUNICATION MESSAGE FORM

PAGE 2

CONTINUATION SHEET

~~PAGEARTWOREDE HQ 0148 S E C R E T~~

TRANSMISSION TO SECRET SERVICE FOLLOWS:

20
18
16
14
12
10

THIS BUREAU HAS RECEIVED INFORMATION FROM VARIOUS SOURCES IN

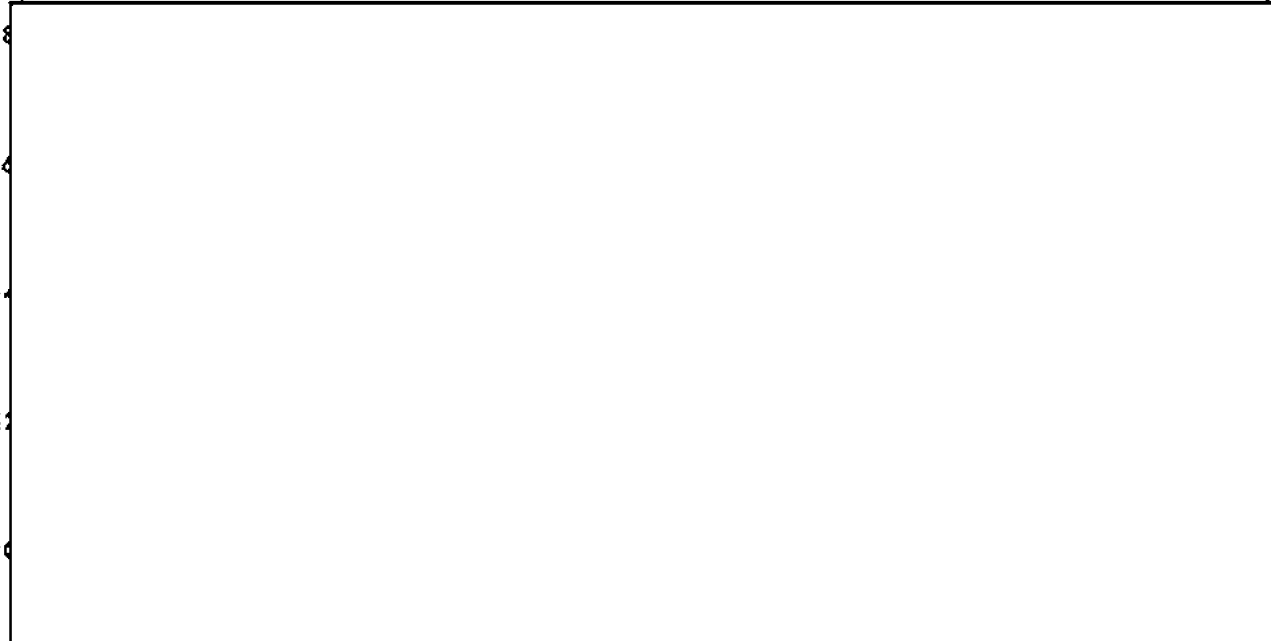

DO NOT TYPE PAST THIS LINE

b3
b6
b7C
b7D

~~CS~~ (U)

OUR SOURCES ARE PARTICULARLY SENSITIVE AND DISSEMINATION OF
THIS INFORMATION COULD SERVE TO COMPROMISE THE SOURCES. NO DIS-
SEMINATION SHOULD BE MADE. IT IS REQUESTED THAT YOU NOT INITIATE
ANY INVESTIGATIVE ACTION AT THIS TIME AS THIS COULD SERVE TO COM-
PROMISE OUR SOURCES. WE WILL EXPEDITIOUSLY FURNISH YOU ANY ADDI-
TIONAL INFORMATION WE MAY RECEIVE. ~~CS~~ (U)

~~C AND E SP26, REASONS (2, 3), DRD SEPTEMBER 21, 1999.~~

DO NOT TYPE MESSAGE BELOW THIS LINE

NOTE:

Asset is [redacted] Information paraphrased from San Juan tel of 9/20/79, captioned "Proposed Visit of Cuban Premier Fidel Castro to the United Nations, October, 1979, PFO Matter. Asset furnished the information [redacted]

[redacted] Should it become known that any U.S. Government Agency has this information, [redacted] [redacted] would be compromised. Secret Service requested to take no overt action in view of preceding. This has been coordinated with CID. (S) (U)

CG, LA MM, NK, NY, WFO AND SJ advised is what information was furnished to Secret Service, and advised that no other information should be discussed. (S) (U)

b3
b6
b7C
b7D
b7E

b6
b7c

RECEIVED
TELETYPE UNIT

5 Oct 79 20 19z

SECTION OF TELECOMMUNICATIONS
COMMUNICATIONS SECTION

Exec AD-Adm.	
Exec AD-Inv.	
Exec AD-LES	
Asst. Dir.:	
Adm. Serv.	
Crim. Inv.	
Ident.	
Intell.	
Laboratory	
Legal Coun.	
Plan. & Insp.	
Rec. Mgmt.	
Tech. Serv.	
Training	
Public Aff. Off.	
Telephone Rm.	

NK0005 2782010

OO HI NY

DE NK

O 052010Z OCT 79

FM NEWARK (185-122)(P)(C-3)

TO DIRECTOR (IMMEDIATE)

NEW YORK (IMMEDIATE)

BT

~~SECRET~~

PROPOSED VISIT OF CUBAN PREMIER FIDEL CASTRO TO THE UNITED STATES

OCTOBER, 1979; PFO MATTER; OO:NEW YORK

RE: BUTEL DATED SEPTEMBER 21, 1979; BUTEL DATED
OCTOBER 4, 1979. (U)

NEWARK HAD NO INQUIRIES FROM USSS REGARDING INFORMATION
CONTAINED IN BUTEL DATED SEPTEMBER 21, 1979 UNTIL
OCTOBER 3, 1979. ON THIS DATE [redacted] USSS,

[redacted] APPEARED AT NEWARK OFFICE AND SHOWED

SA [redacted] A USSS TELETYPE DATED OCTOBER 2, 1979, 11 OCT 15 1979
WHICH SET OUT DETAILS REFERRED TO IN BUTEL DATED OCTOBER 4,

1979 AND WHICH IS APPARENTLY SAME COMMUNICATION RECEIVED BY
USSS AT MIAMI. NEWARK DID NOT ELABORATE ON THIS INFORMATION.

SAC, NEWARK, RECOMMENDS NO ADMINISTRATIVE ACTION.

C AND E 953, REASONS 2 AND 3; DRD OCTOBER 5, 1979.

BT

NOV 16 1979 MF

b6
b7c

b6
b7c

b6
b7c

136

MESSAGE RELAY VIA TELETYPE

DATE 10/4	CLASSIFICATION SECRET	PRECEDENCE PRIORITY
--------------	-------------------------------------	------------------------

FM DIRECTOR FBI

TO
PB

FEDERAL GOVERNMENT

2-2

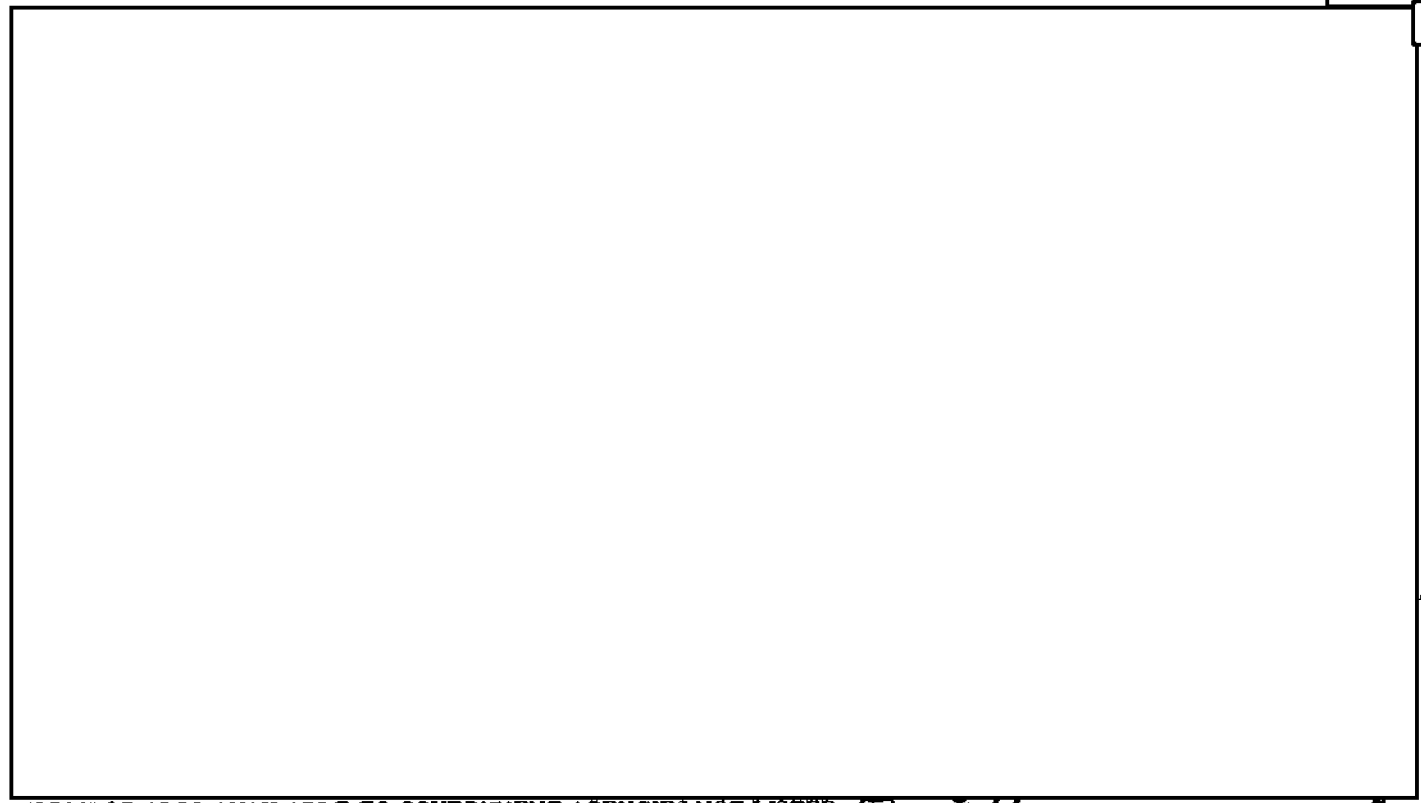

b3
b6
b7C
b7E

(SERVICE ALSO AVAILABLE TO GOVERNMENT AGENCIES NOT LISTED.
CONTACT COMMUNICATIONS CENTER FOR ADDRESSING INFORMATION)
SUBJECT:

185-1241-1

EX-138

23 OCT 4 1979

APPROVED BY [signature]	ORIGINATOR	ROOM 4048	TELE EXT.
----------------------------	------------	--------------	-----------

b6
b7C

FEDERAL BUREAU OF INVESTIGATION
COMMUNICATIONS SECTION
0216
OCT 04 1979

64 OCT 3 1 1979

DO NOT FILE WITHOUT COMMUNICATIONS STAMP

USE OF FORM 0-73

3 OCT 79 22 17
RECEIVED
FEDERAL BUREAU
OF INVESTIGATION
COMMUNICATIONS SECTION

1. Only incoming teletype messages which require transmission relay may be prepared for transmission using form 0-73. Use of form 0-73 is restricted to incoming teletype messages received within the last 3 days which require transmission relay; all other teletype messages must be prepared using form 0-93.
2. Additions such as notes and administrative data for a specific addressee are not allowed. If a note or administrative data is required for a particular addressee a separate 0-73 form must be prepared.
3. The message will be transmitted just as it appears. The person approving the message is solely responsible for assuring all necessary editing changes have been made.

PREPARATION OF FORM WHICH CONSISTS OF A PREPRINTED YELLOW.

1. Complete appropriate boxes: date, classification & precedence.
2. List addresses immediately following the "TO" or place a check mark in the appropriate boxes.
3. Type or PRINT the subject in the space provided.
4. Print or type originator's name, room number and telephone extension.
5. Indicate approval for transmission by initialing the "Approved By" box.

PREPARATION OF MESSAGE TO BE TRANSMITTED

1. Xerox 1 copy of incoming teletype message. A notation shall be made on the original incoming teletype "1 copy made for relay to SACS _____, (OR LEGATS) _____, (OR GOVERNMENT AGENCIES) _____."
2. Minor editing changes shall be made on the xerox as follows: using a lead pencil ONLY draw single line through the first and last lines of the heading and connect these lines from top right to bottom left forming a "Z," figure. (DO NOT OBLITERATE THE HEADING.) Use horizontal lines to delete sentences or words. Printed changes of a word or two to the text of the message may be made; however, changes to the existing text involving more than a word or two necessitate the originator to initiate a new message using form 0-93.
3. Administrative data or notes may be typed immediately following the text and will be transmitted to all addressees.
4. When using the 0-73 form to disseminate information to field offices, Legal Attaches and other Government agencies simultaneously, the text, notes and administrative data must be identical for all addressees.

SJ0175 2750204Z

PP HI CG LA MD NK NY WF

DE SJ

P 010205Z OCT 79

FM SAN JUAN (185-70)

TO DIRECTOR (PRIORITY)

CHICAGO (PRIORITY)

LOS ANGELES (PRIORITY)

MIAMI (PRIORITY)

NEWARK (PRIORITY)

NEW YORK (PRIORITY)

~~WASHINGTON FIELD OFFICE (PRIORITY)~~

BT

~~SECRET~~

PROPOSED VISIT OF CUBAN PREMIER ⁰FIDEL CASTRO TO THE UNITED
NATIONS, OCTOBER, 1979; ~~PRO MATTER, (OO:NEW YORK)~~

~~REFERENCE SAN JUAN TELETYPE, DATED SEPTEMBER 20, 1979.~~

PAGE TWO (185-70) ~~SECRET~~ FBI

ON SEPTEMBER 20, 1979, A SOURCE, WHO HAS PROVIDED
RELIABLE INFORMATION IN THE PAST ADVISED THAT

b3
b6
b7C
b7D

~~(S)~~ (U)

b3
b6
b7C
b7D

PAGE THREE (185-70) ~~SECRET~~

ON SEPTEMBER 28, 1979, A SECOND SOURCE, WHO HAS PROVIDED RELIABLE INFORMATION IN THE PAST, ADVISED THAT

[REDACTED]

b3
b6
b7C
b7D

[REDACTED] ~~(S)~~ (U)

[REDACTED]

b3
b6
b7C
b7D

[REDACTED] SAN JUAN IS UNAWARE OF ANY PUERTO RICO TERRORISTS HAVING PARTICIPATED IN ANY MEETING [REDACTED]

TO DISCUSS THE ABOVE PLOT TO KILL FIDEL CASTRO. ~~(S)~~ (U)

~~C AND E, 8024, REASON 2 AND 3, DRD OCTOBER 1, 1999.~~

ADMINISTRATIVE: FIRST SOURCE IS [REDACTED] SECOND SOURCE IS [REDACTED]

b3
b7D

~~PAGE FOUR (185-70) S E C R E T~~

~~SAN JUAN WILL MAINTAIN CONTACT WITH SOURCES IN AN
ATTEMPT TO MONITOR ANY ANTI-CASTRO PLANNED ACTIVITY
TO DEMONSTRATE OR DISRUPT THE PROPOSED VISIT OF FIDEL CASTRO
TO THE UNITED STATES DURING OCTOBER, 1979.~~

~~BT~~

O-73 (Rev. 10-26-78)

b6
b7C

076

U
A
P
[redacted]

MESSAGE RELAY VIA TELETYPE

DATE 10/11/79	CLASSIFICATION SECRET	PRECEDENCE PRIORITY
------------------	-------------------------------------	------------------------

FM DIRECTOR FBI

TO
✓
FEDERAL GOVERNMENT

[redacted] 2

b3
b6
b7C
b7E

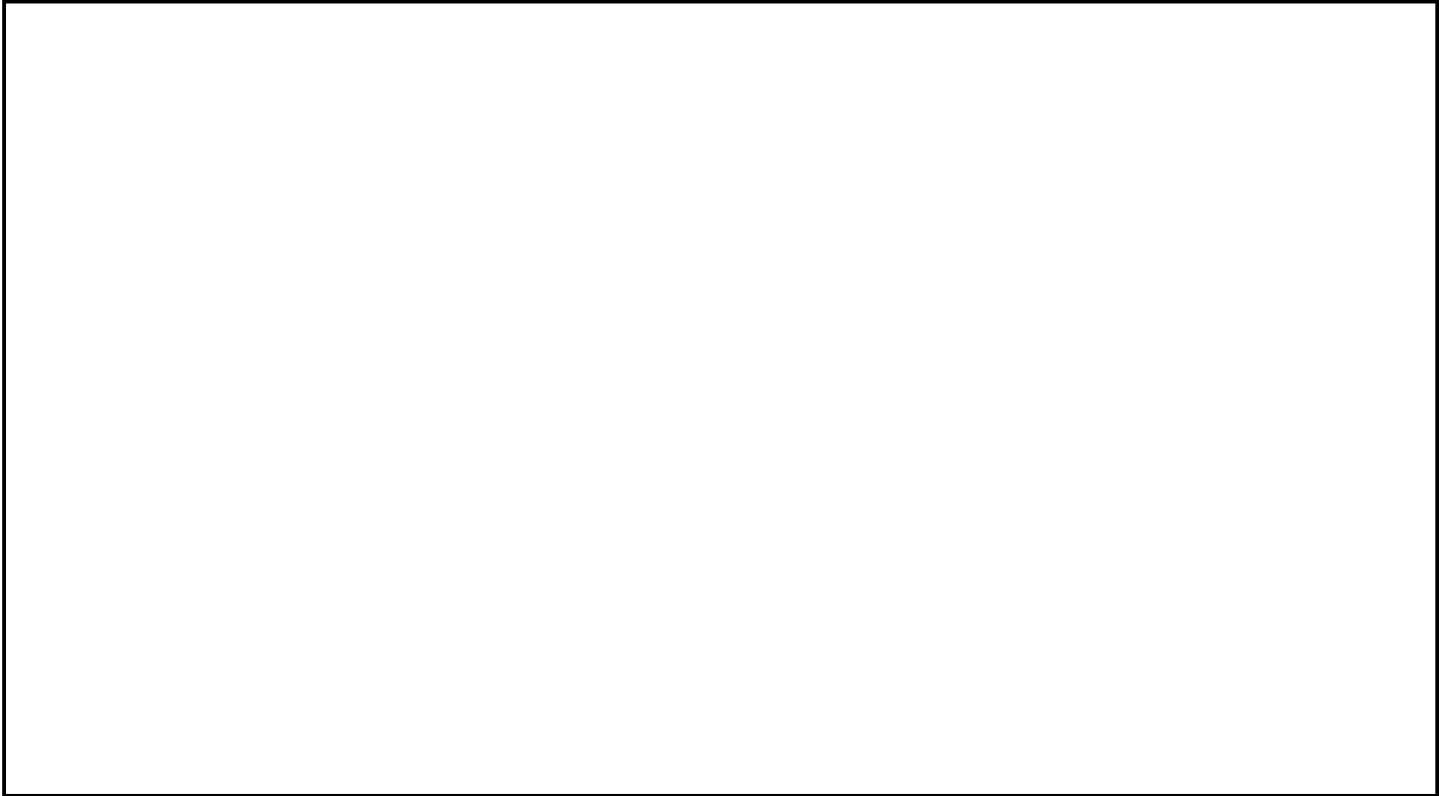

(SERVICE ALSO AVAILABLE TO GOVERNMENT AGENCIES NOT LISTED.
CONTACT COMMUNICATIONS CENTER FOR ADDRESSING INFORMATION)

SUBJECT: PROPOSED VISIT OF CUBAN PREMIER FIDEL CASTRO TO THE U.S.; PFO MATTER.

APPROVED BY #	ORIGINATOR [redacted]	ROOM 4647	TELE EXT. 4605
------------------	--------------------------	--------------	-------------------

11 OCT 12 1979

b6
b7C

FEDERAL BUREAU OF INVESTIGATION
COMMUNICATIONS SECTION
[redacted]
OCT 11 1979

64 NOV 8 1979

DO NOT FILE WITHOUT COMMUNICATIONS STAMP

USE OF FORM 0-73

- 1656
1. Only incoming teletype messages which require transmission relay may be prepared for transmission using form 0-73. Use of form 0-73 is restricted to incoming teletype messages received within the last 3 days which require transmission relay; all other teletype messages must be prepared using form 0-93.
 2. Additions such as notes and administrative data for a specific addressee are not allowed. If a note or administrative data is required for a particular addressee a separate 0-73 form must be prepared.
 3. The message will be transmitted just as it appears. The person approving the message is solely responsible for assuring all necessary editing changes have been made.

PREPARATION OF FORM WHICH CONSISTS OF A PREPRINTED YELLOW.

1. Complete appropriate boxes: date, classification & precedence.
2. List addresses immediately following the "TO" or place a check mark in the appropriate boxes.
3. Type or PRINT the subject in the space provided.
4. Print or type originator's name, room number and telephone extension.
5. Indicate approval for transmission by initialing the "Approved By" box.

PREPARATION OF MESSAGE TO BE TRANSMITTED

1. Xerox 1 copy of incoming teletype message. A notation shall be made on the original incoming teletype. "1 copy made for relay to SACS _____, (OR LEGATS) _____, (OR GOVERNMENT AGENCIES) _____."
2. Minor editing changes shall be made on the xerox as follows: using a lead pencil ONLY draw single line through the first and last lines of the heading and connect these lines from top right to bottom left forming a "Z," figure. (DO NOT OBLITERATE THE HEADING.) Use horizontal lines to delete sentences or words. Printed changes of a word or two to the text of the message may be made; however, changes to the existing text involving more than a word or two necessitate the originator to initiate a new message using form 0-93.
3. Administrative data or notes may be typed immediately following the text and will be transmitted to all addressees.
4. When using the 0-73 form to disseminate information to field offices, Legal Attaches and other Government agencies simultaneously, the text, notes and administrative data must be identical for all addressees.

TELETYPE UNIT

10 OCT 79 00 44z

RECEIVED
FEDERAL BUREAU
OF INVESTIGATION
COMMUNICATIONS SECTION

NY0211 2830026

PP HQ MM NK

DE NY 0026

P092328Z OCT 79

FM NEW YORK [REDACTED] (#44)

TO DIRECTOR PRIORITY

MIAMI PRIORITY

NEWARK PRIORITY

BT

~~SECRET~~

~~VISIT OF FIDEL CASTRO TO NEW YORK CITY - [REDACTED] OO.
NEW YORK~~

~~ON OCTOBER 8, 1979, A SENSITIVE SOURCE WHO HAS FURNISHED
RELIABLE INFORMATION IN THE PAST ADVISED THAT [REDACTED]~~



b6
b7C

b3
b7E

b3
b7E

b3
b6
b7C
b7D

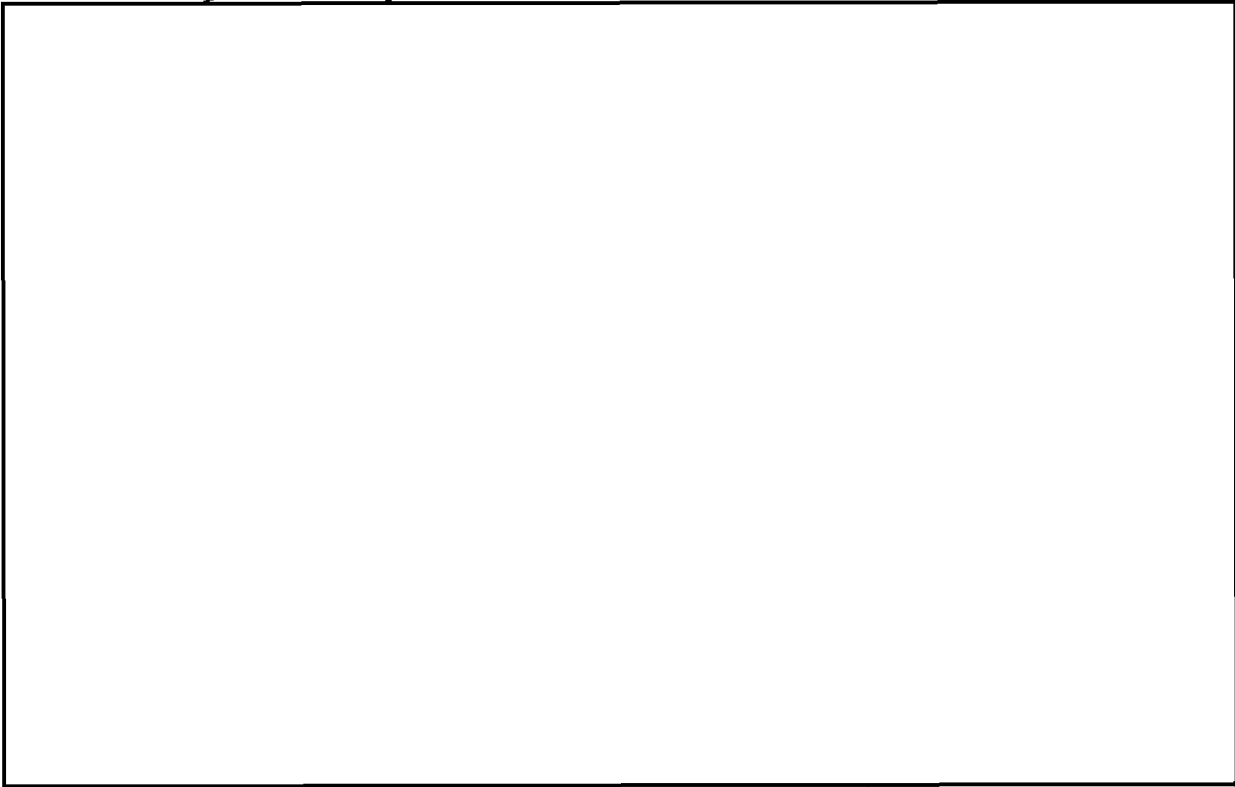

b3
b6
b7C
b7D

ON OCTOBER 9, 1979, A CONFIDENTIAL SOURCE WHO HAS PROVIDED RELIABLE INFORMATION IN THE PAST ADVISED THAT [REDACTED]

b3
b6
b7C
b7D

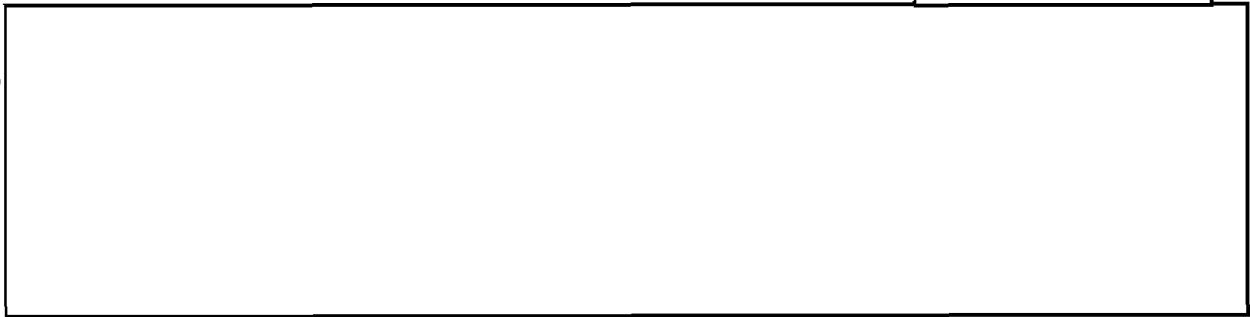

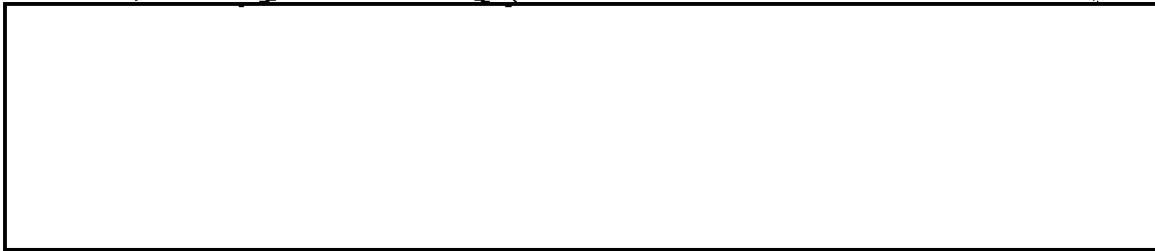

b3
b7D

SOURCE ADVISED THAT

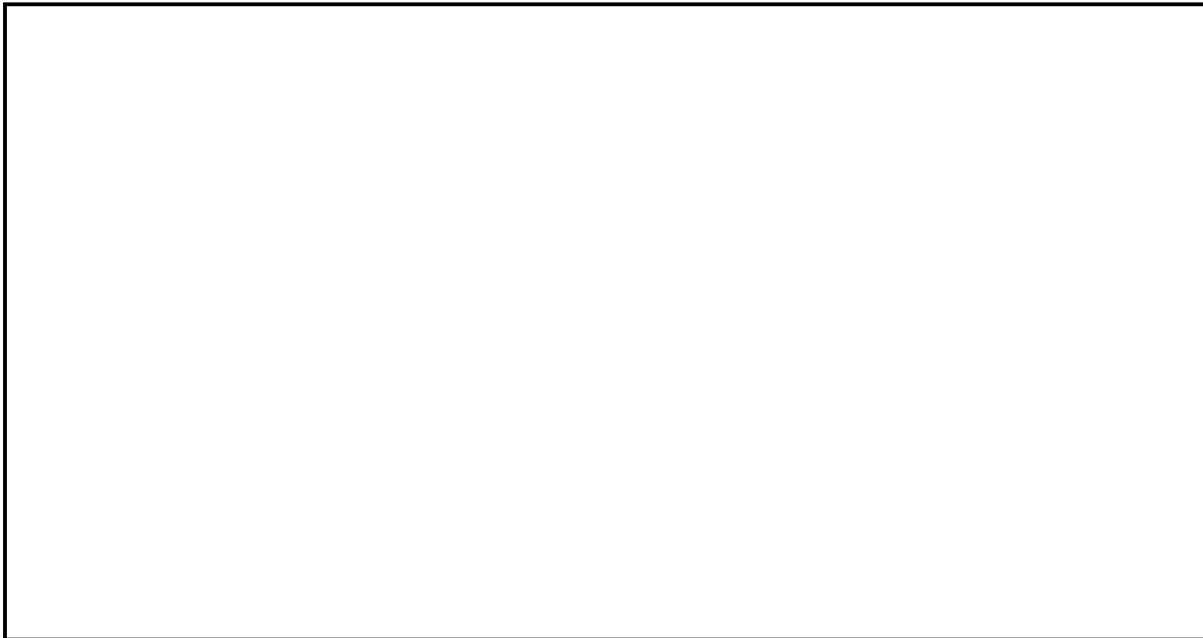

b3
b6
b7C
b7D

~~SENSITIVE SOURCE MENTIONED IS [REDACTED] AND CONFIDENTIAL~~

b3
b7D

SOURCE MENTIONED IS [REDACTED]

~~THIS information should not be disseminated outside your agency without FBI concurrence.~~
~~ABOVE BEING FURNISHED TO [REDACTED] AND NEWARK FOR INFORMATION PURPOSES.~~

CEE 5236, Reasons 2:3, JRD 10/10/79

~~PAGE FOUR SECRET~~

~~CARD E 3441, REASONS 2 AND 3, DND OCTOBER 9, 1955.~~

~~SECRET~~

NY 213

b6
b7C

118

O- [redacted]
A- [redacted]
P- [redacted]

MESSAGE RELAY VIA TELETYPE

DATE 10/11/79	CLASSIFICATION <i>Confidential</i>	PRECEDENCE <i>ROUTINE</i>
------------------	---------------------------------------	------------------------------

FM DIRECTOR FBI

TO

FEDERAL GOVERNMENT

2

b3
b6
b7C
b7E



(SERVICE ALSO AVAILABLE TO GOVERNMENT AGENCIES NOT LISTED.
CONTACT COMMUNICATIONS CENTER FOR ADDRESSING INFORMATION)

SUBJECT:

*VISIT OF CUBAN PREMIER FIDEL CASTRO
TO THE U.S.*

NY REC-81 / 85-1241-12
4DA

APPROVED BY <i>[initials]</i>	ORIGINATOR [redacted]	ROOM 4147	TELE EXT. 4608
----------------------------------	--------------------------	--------------	-------------------

3 OCT 12 1979

b6
b7C

63 NOV 7 1979

FEDERAL BUREAU OF INVESTIGATION
COMMUNICATIONS SECTION
0247
OCT 12 1979

DO NOT FILE WITHOUT COMMUNICATIONS STAMP

USE OF FORM 0-73

1. Only incoming teletype messages which require transmission relay may be prepared for transmission using form 0-73. Use of form 0-73 is restricted to incoming teletype messages received within the last 3 days which require transmission relay; all other teletype messages must be prepared using form 0-93.
2. Additions such as notes and administrative data for a specific addressee are not allowed. If a note or administrative data is required for a particular addressee a separate 0-73 form must be prepared.
3. The message will be transmitted just as it appears. The person approving the message is solely responsible for assuring all necessary editing changes have been made.

PREPARATION OF FORM WHICH CONSISTS OF A PREPRINTED YELLOW.

1. Complete appropriate boxes: date, classification & precedence.
2. List addresses immediately following the "TO" or place a check mark in the appropriate boxes.
3. Type or PRINT the subject in the space provided.
4. Print or type originator's name, room number and telephone extension.
5. Indicate approval for transmission by initialing the "Approved By" box.

PREPARATION OF MESSAGE TO BE TRANSMITTED

1. Xerox 1 copy of incoming teletype message. A notation shall be made on the original incoming teletype "1 copy made for relay to SACS _____, (OR LEGATS) _____, (OR GOVERNMENT AGENCIES) _____."
2. Minor editing changes shall be made on the xerox as follows: using a lead pencil ONLY draw single line through the first and last lines of the heading and connect these lines from top right to bottom left forming a "Z," figure. (DO NOT OBLITERATE THE HEADING.) Use horizontal lines to delete sentences or words. Printed changes of a word or two to the text of the message may be made; however, changes to the existing text involving more than a word or two necessitate the originator to initiate a new message using form 0-93.
3. Administrative data or notes may be typed immediately following the text and will be transmitted to all addressees.
4. When using the 0-73 form to disseminate information to field offices, Legal Attaches and other Government agencies simultaneously, the text, notes and administrative data must be identical for all addressees.

b6
b7C

RECEIVED
TELETYPE UNIT

Exec AD-Adm.	
Exec AD-LES	
Asst. Dir.:	
Adm. Serv.	
Crim. Inv.	
Ident.	
Insp.	
Intell.	
Laboratory	
Legal Coun.	
Plan. & Insp.	
Rec. Mgnt.	
Tech. Serv.	
Training	
Public Affs. Off.	
Telephone Rm.	
Director's Sec'y	

NY0213 2830053

10 OCT 79 00 55

PP HQ

FEDERAL BUREAU
OF INVESTIGATION
COMMUNICATIONS SECTION

DE NY 0035

P090042Z OCT 7

b3

FM NEW YORK [redacted] (# 44)

b6

TO DIRECTOR PRIORITY

b7C

BT

b7E

~~CONFIDENTIAL~~

VISIT OF FIDEL CASTRO IN CONNECTION WITH THE UNITED NATIONS

GENERAL ASSEMBLY, OCTOBER, 1979, [redacted]

b3
b7E

ON OCTOBER 8, 1979, A HIGHLY SENSITIVE CONFIDENTIAL

SOURCE WHO HAS FURNISHED RELIABLE INFORMATION IN THE PAST

ADVISED THAT [redacted]

b3
b6
b7C
b7D

This information should not be disseminated outside your agency without FBI concurrence.

~~ADMINISTRATIVE:~~

~~CONFIDENTIAL SOURCE IS [redacted]~~

b3
b7D

~~C AND E 3111, REASONS 2 AND 3, DRD OCTOBER 17, 1999.~~

5236

BT

BY: [redacted]
[redacted]
[redacted]
A [redacted]
P [redacted]

MESSAGE RELAY VIA TELETYPE

128

JHG

DATE 10/10/79	CLASSIFICATION CONFIDENTIAL	PRECEDENCE IMMEDIATE
------------------	---	-------------------------

FM DIRECTOR FBI

TO BROOKLYN-QUEENS
NEW ROCHELLE
NEW YORK

[redacted]

2-2

b3
b6
b7c
b7e

[Large redacted area]

(SERVICE ALSO AVAILABLE TO GOVERNMENT AGENCIES NOT LISTED)
CONTACT COMMUNICATIONS CENTER FOR ADDRESSING INFORMATIONAL
SUBJECT:

REC-110

145-1241-13

SEE ATTACHED.

EX-138

OCT 12 1979

APPROVED BY <i>[Signature]</i>	ORIGINATOR [redacted]	ROOM 5027	TELE EXT. 2805
-----------------------------------	--------------------------	--------------	-------------------

[redacted]

b6
b7c

0204
OCT 11 1979

DO NOT FILE WITHOUT COMMUNICATIONS STAMP

63 NOV

[redacted]

OCT 16 1973

USE OF FORM 0-73

1. Only incoming teletype messages which require transmission relay may be prepared for transmission using form 0-73. Use of form 0-73 is restricted to incoming teletype messages received within the last 3 days which require transmission relay; all other teletype messages must be prepared using form 0-93.
2. Additions such as notes and administrative data for a specific addressee are not allowed. If a note or administrative data is required for a particular addressee, a separate 0-73 form must be prepared.
3. The message will be transmitted just as it appears. The person approving the message is solely responsible for assuring all necessary editing changes have been made.

PREPARATION OF FORM WHICH CONSISTS OF A PREPRINTED YELLOW.

1. Complete appropriate boxes: date, classification & precedence.
2. List addresses immediately following the "TO" or place a check mark in the appropriate box.
3. Type or PRINT the subject in the space provided.
4. Print or type originator's name, room number and telephone extension.
5. Indicate approval for transmission by initialing the "Approved By" box.

RECEIVED
FEDERAL BUREAU
OF INVESTIGATION
COMMUNICATIONS SECTION

10 OCT 19 23 32

PREPARATION OF MESSAGE TO BE TRANSMITTED

1. Xerox 1 copy of incoming teletype message. A notation shall be made on the original incoming teletype "1 copy made for relay to SACS _____, (OR LEGATS) _____, (OR GOVERNMENT AGENCIES) _____."
2. Minor editing changes shall be made on the xerox as follows: using a lead pencil ONLY draw single line through the first and last lines of the heading and connect these lines from top right to bottom left forming a "Z," figure. (DO NOT OBLITERATE THE HEADING.) Use horizontal lines to delete sentences or words. Printed changes of a word or two to the text of the message may be made; however, changes to the existing text involving more than a word or two necessitate the originator to initiate a new message using form 0-93.
3. Administrative data or notes may be typed immediately following the text and will be transmitted to all addressees.
4. When using the 0-73 form to disseminate information to field offices, Legal Attaches and other Government agencies simultaneously, the text, notes and administrative data must be identical for all addressees.

MESSAGE RELAY VIA TELETYPE

068

DATE 10/10/79	CLASSIFICATION CONFIDENTIAL	PRECEDENCE PRIORITY
------------------	---	------------------------

FM DIRECTOR FBI

TO FBI NEW YORK

2

b3
b6
b7C
b7E



(SERVICE ALSO AVAILABLE TO GOVERNMENT AGENCIES NOT LISTED.
 CONTACT COMMUNICATIONS CENTER FOR ADDRESSING INFORMATION)

SUBJECT: PROPOSED VISIT OF CUBAN PREMIER
 FIDEL CASTRO TO THE U.S. PFO MATTER.

EX-109 / 85 - 1241-14

APPROVED BY #	ROOM 4147	TELE EXT. 4605
------------------	--------------	-------------------

OCT 12 1979

60
OCT 08 1979

COMMUNICATIONS CENTER
 1107-2
 OCT 11 1979

53
67
103

USE OF FORM 0-73

1. Only incoming teletype messages which require transmission relay may be prepared for transmission using form 0-73. Use of form 0-73 is restricted to incoming teletype messages received within the last 3 days which require transmission relay; all other teletype messages must be prepared using form 0-93.
2. Additions such as notes and administrative data for a specific addressee are not allowed. If a note or administrative data is required for a particular addressee a separate 0-73 form must be prepared.
3. The message will be transmitted just as it appears. The person approving the message is solely responsible for assuring all necessary editing changes have been made.

PREPARATION OF FORM WHICH CONSISTS OF A PREPRINTED YELLOW.

1. Complete appropriate boxes: date, classification & precedence.
2. List addresses immediately following the "TO" or place a check mark in the appropriate boxes.
3. Type or PRINT the subject in the space provided.
4. Print or type originator's name, room number and telephone extension.
5. Indicate approval for transmission by initialing the "Approved By" box.

PREPARATION OF MESSAGE TO BE TRANSMITTED

1. Xerox 1 copy of incoming teletype message. A notation shall be made on the original incoming teletype "1 copy made for relay to SACS _____, (OR LEGATS) _____, (OR GOVERNMENT AGENCIES) _____".
2. Minor editing changes shall be made on the xerox as follows: using a lead pencil ONLY draw single line through the first and last lines of the heading and connect these lines from top right to bottom left forming a "Z," figure. (DO NOT OBLITERATE THE HEADING.) Use horizontal lines to delete sentences or words. Printed changes of a word or two to the text of the message may be made; however, changes to the existing text involving more than a word or two necessitate the originator to initiate a new message using form 0-93.
3. Administrative data or notes may be typed immediately following the text and will be transmitted to all addressees.
4. When using the 0-73 form to disseminate information to field offices, Legal Attaches and other Government agencies simultaneously, the text, notes and administrative data must be identical for all addressees.

19 OCT 19 17 17
RECEIVED
FEDERAL BUREAU OF INVESTIGATION
COMMUNICATIONS SECTION

G
A
P

MESSAGE RELAY VIA TELETYPE

108

DATE 10/10/79	CLASSIFICATION UNCL	PRECEDENCE Priority
------------------	------------------------	------------------------

FM DIRECTOR FBI

TO

FEDERAL GOVERNMENT

b3
b6
b7C
b7E

(SERVICE ALSO AVAILABLE TO GOVERNMENT AGENCIES NOT LISTED.
CONTACT COMMUNICATIONS CENTER FOR ADDRESSING INFORMATION)
SUBJECT:

185-1241-15

CAZVIZ

OCT 11 1979

APPROVER	ORIGINATOR	ROOM 4048	TELE EXT. 4660
----------	------------	--------------	-------------------

b6
b7C

60 NOV 08 1979

FEDERAL BUREAU OF INVESTIGATION
COMMUNICATIONS SECTION
OCT 11 1979 0304

DO NOT FILE WITHOUT COMMUNICATIONS STAMP

LUD 70 00

PH 11/1

b6
b7c

cc 11/3/74

USE OF FORM 0-73

1. Only incoming teletype messages which require transmission relay may be prepared for transmission using form 0-73. Use of form 0-73 is restricted to incoming teletype messages received within the last 3 days which require transmission relay; all other teletype messages must be prepared using form 0-93.
2. Additions such as notes and administrative data for a specific addressee are not allowed. If a note or administrative data is required for a particular addressee a separate 0-73 form must be prepared.
3. The message will be transmitted just as it appears. The person approving the message is solely responsible for assuring all necessary editing changes have been made.

PREPARATION OF FORM WHICH CONSISTS OF A PREPRINTED YELLOW.

1. Complete appropriate boxes: date, classification & precedence.
2. List addresses immediately following the "TO" or place a check mark in the appropriate boxes.
3. Type or PRINT the subject in the space provided.
4. Print or type originator's name, room number and telephone extension.
5. Indicate approval for transmission by initialing the "Approved By" box.

REC'D
FEDERAL BUREAU
OF INVESTIGATION
COMMUNICATIONS SECTION

10 OCT 79 21 11

PREPARATION OF MESSAGE TO BE TRANSMITTED

1. Xerox 1 copy of incoming teletype message. A notation shall be made on the original incoming teletype "1 copy made for relay to SACS _____, (OR LEGATS) _____, (OR GOVERNMENT AGENCIES) _____."
2. Minor editing changes shall be made on the xerox as follows: using a lead pencil ONLY draw single line through the first and last lines of the heading and connect these lines from top right to bottom left forming a "Z," figure. (DO NOT OBLITERATE THE HEADING.) Use horizontal lines to delete sentences or words. Printed changes of a word or two to the text of the message may be made; however, changes to the existing text involving more than a word or two necessitate the originator to initiate a new message using form 0-93.
3. Administrative data or notes may be typed immediately following the text and will be transmitted to all addressees.
4. When using the 0-73 form to disseminate information to field offices, Legal Attaches and other Government agencies simultaneously, the text, notes and administrative data must be identical for all addressees.

NYO228 2831358Z

RR HQ CG LA MM HK SF SJ UF

DE NY 005

R 101300Z OCT 79

FM NEW YORK (M-10)

TO DIRECTOR ROUTINE

CHICAGO ROUTINE

LOS ANGELES ROUTINE

MIAMI ROUTINE

NEWARK ROUTINE

SAN FRANCISCO ROUTINE

SAN JUAN ROUTINE (SJ VIA WAHQ)

WASHINGTON FIELD ROUTINE

BT

~~UNCLAS E F T O~~

~~CAZVIZ; PFO; OO: NEW YORK.~~

FIDEL

visit of PREMIER CASTRO to U.N.

~~REFERENCE BUREAU TELETYPE, OCTOBER 8, 1979.~~

FBI

ON OCTOBER 8, 1979, SPECIAL AGENTS OF THE NYO ATTENDED A CONFERENCE AT NEW YORK CITY POLICE DEPARTMENT (NYCPD) HEAD-QUARTERS RELATIVE TO THE VISIT OF CUBAN PREMIER FIDEL CASTRO. THE FOLLOWING INFORMATION WAS SET FORTH:

CASTRO WILL ARRIVE LATE EVENING, OCTOBER 9, 1979 OR ON

PAGE TWO U N C L A S E F T O

OCTOBER 10, 1979. TWO HOURS PRIOR TO HIS ARRIVAL, TWO CUBAN PLANES CARRYING CUBAN SECURITY PERSONNEL AND PRESS WILL ARRIVE. THE CUBAN FOREIGN MINISTER, WHO IS ALREADY IN NEW YORK, WILL GREET CASTRO AT JFK INTERNATIONAL AIRPORT. THE CUBAN VICE PRESIDENT WILL ACCOMPANY CASTRO BUT WILL EXIT THE PLANE SEPARATELY FROM CASTRO. CASTRO, THE VICE PRESIDENT, AND THE FOREIGN MINISTER WILL PROCEED BY THREE SEPARATE MOTORCADES TO THE CUBAN MISSION TO THE UNITED NATIONS (CMUN), UTILIZING THE SAME ROUTE. CASTRO IS SCHEDULED TO RESIDE AT THE CMUN. THE VICE PRESIDENT WILL POSSIBLY RESIDE WITH THE FOREIGN MINISTER AT THE AMBASSADOR'S RESIDENCE, [REDACTED]

THE NYCPD WILL MAINTAIN A MOBILE COMMANDPOST IN THE VICINITY OF THE CMUN AT 305 LEXINGTON AVENUE. THE UNITED STATES SECRET SERVICE WILL MAINTAIN A COMMANDPOST AT [REDACTED]

[REDACTED] THE COMMANDPOST AT [REDACTED] WILL BE AT [REDACTED]

NYCPD INTELLIGENCE DIVISION AND UNITED STATES SECRET SERVICE WILL ATTEMPT TO ESTABLISH A COMMANDPOST [REDACTED] FOR PERSONNEL WHO HAVE THE IMMEDIATE SECURITY RESPONSIBILITY FOR CASTRO.

b6
b7C
b7E

PAGE THREE U N C L A S E F T O

THE UNITED STATES DEPARTMENT OF STATE WILL HAVE THE PRIMARY RESPONSIBILITY FOR PROTECTION OF THE VICE PRESIDENT IN ADDITION TO THE PROTECTION RESPONSIBILITY FOR THE FOREIGN MINISTER.

FIDEL CASTRO IS SCHEDULED TO SPEAK BEFORE THE UNITED NATIONS GENERAL ASSEMBLY AT 3:00 PM, OCTOBER 12, 1979. ANTI-CASTRO CUBAN EXILES WILL BE PERMITTED TO DEMONSTRATE AT DAG HAMMERSKJOLD PLAZA, EAST 47TH STREET AND FIRST AVENUE, WHILE PRO-CASTRO GROUPS WILL BE CONFINED TO FIRST AVENUE, SOUTH OF EAST 42ND STREET.

ANY ANTI-CASTRO DEMONSTRATIONS AT THE CMUN WILL BE CONFINED TO LEXINGTON AVENUE, SOUTH OF EAST 37TH STREET, AND THE PRO-CASTRO PEOPLE WILL BE ALLOWED TO DEMONSTRATE ON LEXINGTON AVENUE, NORTH OF EAST 38TH STREET.

BT

G
A
P

MESSAGE RELAY VIA TELETYPE

099

DATE 10/10/79	CLASSIFICATION CONFIDENTIAL	PRECEDENCE PRIORITY
------------------	---	------------------------

FM DIRECTOR FBI

TO

FEDERAL GOVERNMENT

b3
b6
b7C
b7E

2-1,2
[redacted]

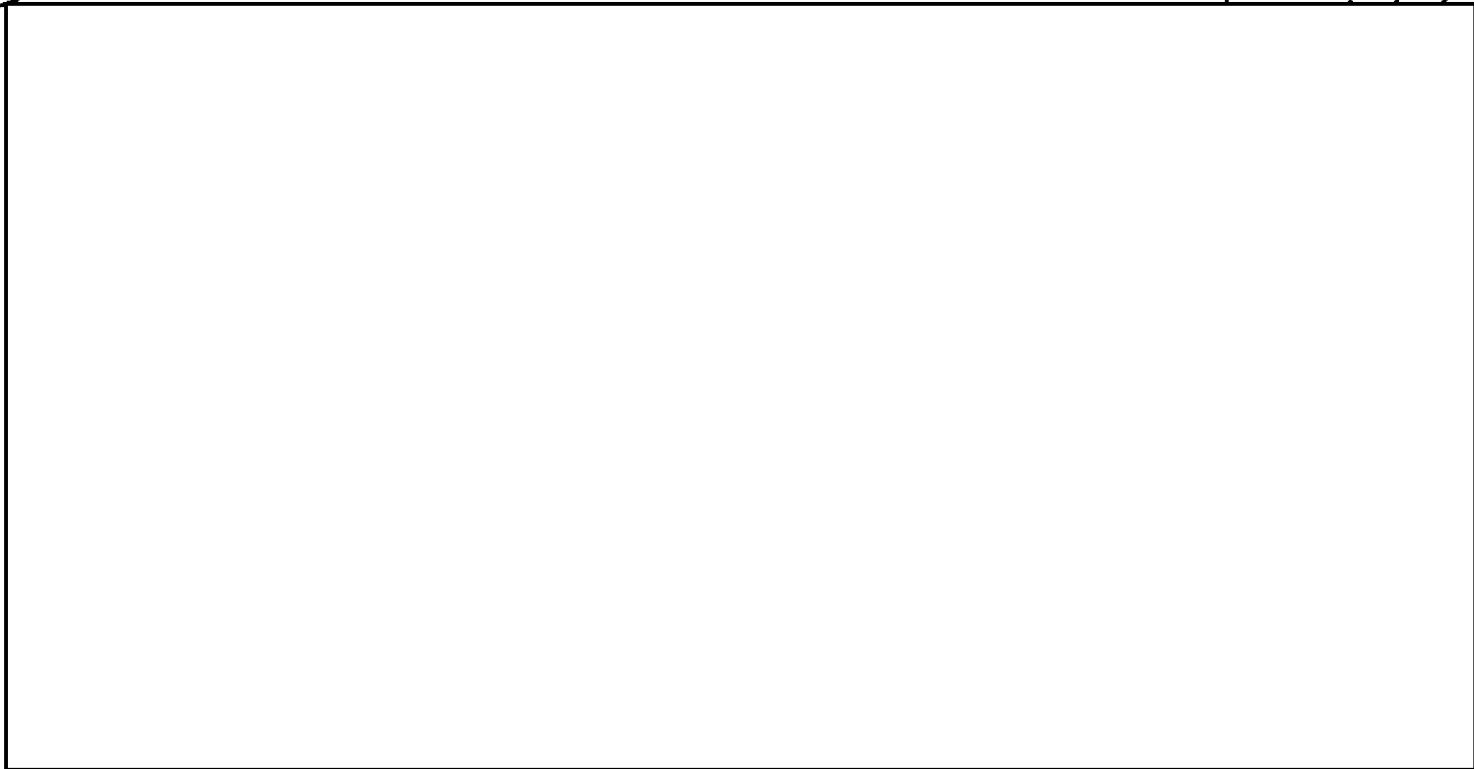

(SERVICE ALSO AVAILABLE TO GOVERNMENT AGENCIES NOT LISTED)
CONTACT COMMUNICATIONS CENTER FOR ADDRESSING INFORMATION

185-1241-16

SUBJECT:

O'CARVIZ

OCT 11 1979

APPROVED [signature]	ORIGINATOR [redacted]	ROOM 4048	TELE EXT. 4660
-------------------------	--------------------------	--------------	-------------------

b6
b7C

60 NOV 08 1979

FEDERAL BUREAU OF INVESTIGATION
COMMUNICATIONS SECTION
OCT 11 1979

DO NOT FILE WITHOUT COMMUNICATIONS STAMP

LWD TO OC
PH 11/1
02-11-2-11
b6
b7C

USE OF FORM 0-73

1. Only incoming teletype messages which require transmission relay may be prepared for transmission using form 0-73. Use of form 0-73 is restricted to incoming teletype messages received within the last 3 days which require transmission relay; all other teletype messages must be prepared using form 0-93.
2. Additions such as notes and administrative data for a specific addressee are not allowed. If a note or administrative data is required for a particular addressee a separate 0-73 form must be prepared.
3. The message will be transmitted just as it appears. The person approving the message is solely responsible for assuring all necessary editing changes have been made.

PREPARATION OF FORM WHICH CONSISTS OF A PREPRINTED YELLOW.

1. Complete appropriate boxes: date, classification & precedence.
2. List addresses immediately following the "TO" or place a check mark in the appropriate boxes.
3. Type or PRINT the subject in the space provided.
4. Print or type originator's name, room number and telephone extension.
5. Indicate approval for transmission by initialing the "Approved By" box.

RECEIVED
FEDERAL BUREAU
OF INVESTIGATION
COMMUNICATIONS SECTION
10 OCT 19 20 47

PREPARATION OF MESSAGE TO BE TRANSMITTED

1. Xerox 1 copy of incoming teletype message. A notation shall be made on the original incoming teletype "1 copy made for relay to SACS _____, (OR LEGATS) _____, (OR GOVERNMENT AGENCIES) _____."
2. Minor editing changes shall be made on the xerox as follows: using a lead pencil ONLY draw single line through the first and last lines of the heading and connect these lines from top right to bottom left forming a "Z," figure. (DO NOT OBLITERATE THE HEADING.) Use horizontal lines to delete sentences or words. Printed changes of a word or two to the text of the message may be made; however, changes to the existing text involving more than a word or two necessitate the originator to initiate a new message using form 0-93.
3. Administrative data or notes may be typed immediately following the text and will be transmitted to all addressees.
4. When using the 0-73 form to disseminate information to field offices, Legal Attaches and other Government agencies simultaneously, the text, notes and administrative data must be identical for all addressees.

NY0214 2830112

OO HQ CG MM NK SF HI WF

DE NY 0034

0090041Z OCT 79

FM NEW YORK (185-899) (M-10)

TO DIRECTOR IMMEDIATE

CHICAGO IMMEDIATE

MIAMI IMMEDIATE

NEWARK IMMEDIATE

SAN FRANCISCO IMMEDIATE (VIA FBIHQ)

SAN JUAN IMMEDIATE (VIA FBIHQ)

~~WASHINGTON FIELD IMMEDIATE (VIA FBIHQ)~~

~~CONFIDENTIAL~~

~~CAZVIZ; PFO; OO: NEW YORK. VISIT OF PREMIER FIDEL CASTRO
UN OCTOBER 11, 1979~~

~~REFERENCE BUREAU TELETYPE, OCTOBER 8, 1979 AND NEW YORK
ROUTINE TELETYPE, OCTOBER 9, 1979.~~

~~THIS TELETYPE IS CLASSIFIED CONFIDENTIAL IN THAT INFOR-
MATION CONTAINED HEREIN HAS NOT BEEN MADE PUBLIC.~~

~~ON OCTOBER 9, 1979, SUPERVISORY SPECIAL AGENT [REDACTED]~~

[REDACTED] UNITED STATES SECRET SERVICE (USSS), NEW YORK,
NEW YORK, ADVISED THAT ^{THEY} HE RECEIVED INFORMATION FROM THE

PAGE TWO ~~C O N F I D E N T I A L~~

CUBAN MISSION TO THE UNITED NATIONS THAT FIDEL CASTRO WILL ARRIVE AT JOHN F. KENNEDY INTERNATIONAL AIRPORT (JFKIA) BETWEEN 1:00 AM AND 2:00 AM, OCTOBER 11, 1979. CASTRO WILL IMMEDIATELY BE ESCORTED TO THE CUBAN MISSION TO THE UNITED NATIONS, 305 LEXINGTON AVENUE, MANHATTAN.

~~C AND E 5815, REASONS 2 AND 3, DRD OCTOBER 9, 1999.~~

BT

DECLASSIFIED 10/1/01

DEPARTMENT OF JUSTICE
FEDERAL BUREAU OF INVESTIGATION
COMMUNICATION MESSAGE FORM

b6
b7C

PAGE 1 OF 5	CLASSIFICATION UNCLAS: E F T O	PRECEDENCE ROUTINE
DATE 10-10-79	#FOO5RR CG LA MM NK NY SF SJ WFSDE HQ H0005 #H	

START TIME
110139Z OCT 79

FM

DIRECTOR FBI

TO

FBI NEW YORK ROUTINE

FBI NEWARK ROUTINE

14

FBI MIAMI ROUTINE

FBI SAN JUAN ROUTINE

12

FBI WASHINGTON FIELD ROUTINE

FBI LOS ANGELES ROUTINE

10

FBI CHICAGO ROUTINE

FBI SAN FRANCISCO ROUTINE

8

BT

UNCLAS: E F T O

PAZVIZ; PFO; OO: NEW YORK.

REFERENCE FBIHQ TELETYPE DATED OCTOBER 8, 1979.

ON OCTOBER 10, 1979, [REDACTED] PROVIDED A

[REDACTED]

[REDACTED]

REC-11

DO NOT TYPE MESSAGE BELOW THIS LINE

APPROVED BY [Signature]	DRAFTED BY [REDACTED]	DATE 10-10-79	ROOM 4051	TELE EXT. 4632
----------------------------	--------------------------	------------------	--------------	-------------------

- 1 - [REDACTED]
- 1 - [REDACTED]
- 1 - [REDACTED]
- 1 - [REDACTED]
- 1 - [REDACTED]
- 1 - [REDACTED]

SEE NOTE ON PAGE 6 6 OCT 12 1979

64 NOV 13 1979

FEDERAL BUREAU OF INVESTIGATION
COMMUNICATIONS SECTION
0447-2
OCT 11 1979

DO NOT FILE WITHOUT COMMUNICATIONS STAMP

b6
b7C

b6
b7C

b7E

b6
b7C

Exec. AD-Inv.	_____
Exec. AD-Adm.	_____
Exec. AD-LES	_____
Asst. Dir.:	
Adm. Servs.	_____
Crim. Inv.	_____
Ident.	_____
Intell.	_____
Laboratory	_____
Legal Coun.	_____
Plan. & Insp.	_____
Rec. Mgmt.	_____
Tech. Servs.	_____
Training	_____
Public Aff. Off.	_____
Telephone Rm.	_____
Director's Study	_____

b6
b7C

b3
b6
b7C
b7E

TELETYPE UNIT

18 OCT 79 10 3 11z

RECEIVED BY
FEDERAL BUREAU
OF INVESTIGATION
COMMUNICATIONS SECTION

[redacted]
R 181135Z OCT 79
FM [redacted] (185-18) (P)
TO DIRECTOR FBI ROUTINE [redacted]
BT

~~CONFIDENTIAL~~

CAZVIZ, PFO. OO - NEW YORK.
RELONTEL 10/15/79.

[redacted] ADVISED THAT [redacted]

[redacted] (S) (U)

[redacted]

[redacted] (S) (U)

NEW YORK OFFICE REQUESTED TO HANDLE AND ADVISE.
FBIHQ RELAY TO NEW YORK.

11-18

~~C. & 3 G-1, REASON (1); DORD: OCTOBER 18, 2009~~

OCT 26 1979

BT

[redacted]

b6
b7C

64 NOV 7 1979

U
A
P



MESSAGE RELAY VIA TELETYPE

050

DATE 10/18/79	CLASSIFICATION CONFIDENTIAL	PRECEDENCE ROUTINE
------------------	---	-----------------------

FM DIRECTOR FBI
TO ADIC NY



b3
b6
b7C
b7E

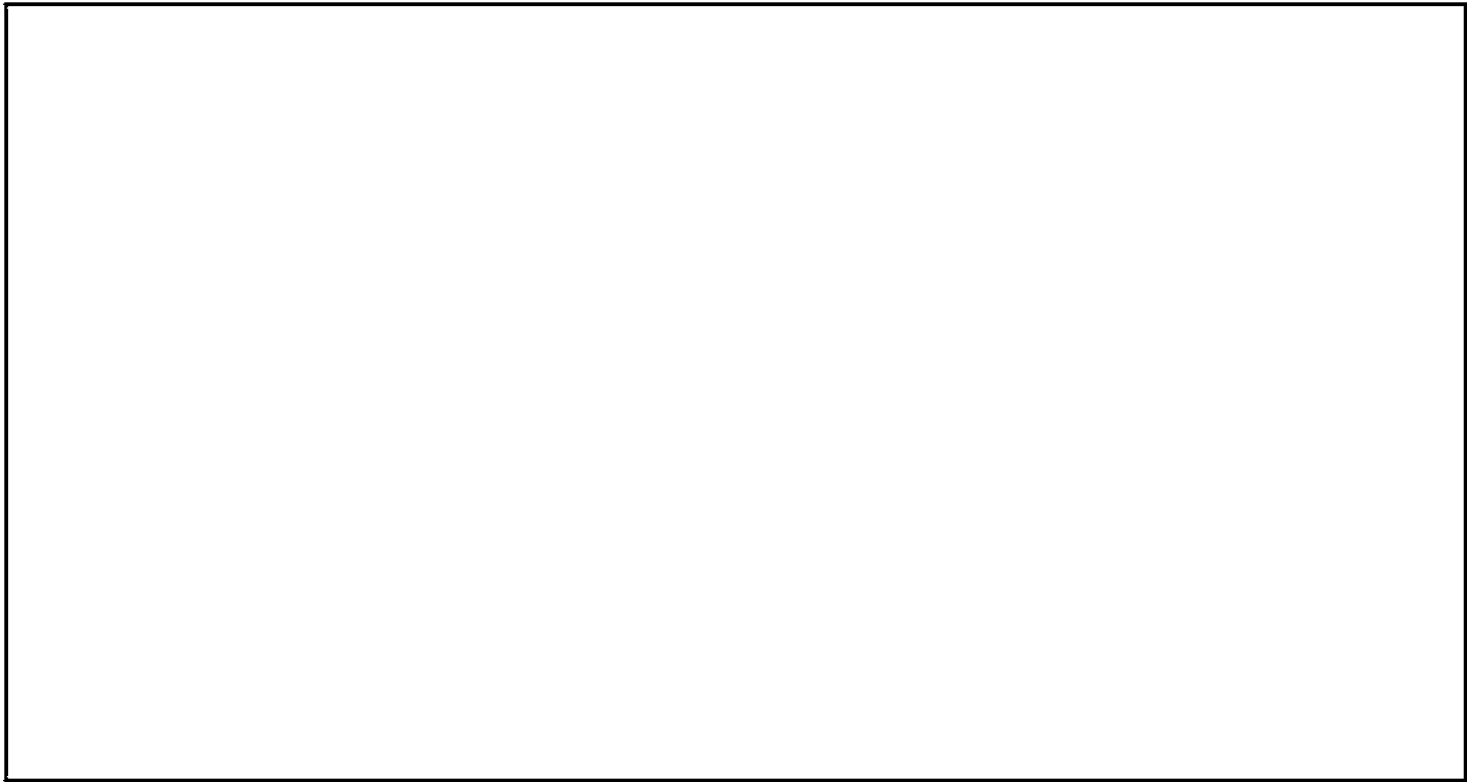

(SERVICE ALSO AVAILABLE TO GOVERNMENT AGENCIES NOT LISTED.
CONTACT COMMUNICATIONS CENTER FOR ADDRESSING INFORMATION)
SUBJECT:

185-1241-19

17 OCT 26 1979

APPROVED BY <i>[Signature]</i>	ORIGINATOR [redacted]	ROOM 4048	TELE EXT. 4660
-----------------------------------	--------------------------	--------------	-------------------

b6
b7C

FEDERAL BUREAU OF INVESTIGATION
COMMUNICATIONS SECTION
1207
OCT 19 1979

64 NOV 7 1979

DO NOT FILE WITHOUT COMMUNICATIONS STAMP

USE OF FORM 0-73

19 Oct 79 14 58

1. Only incoming teletype messages which require transmission relay may be prepared for transmission using form 0-73. Use of form 0-73 is restricted to incoming teletype messages received within the last 3 days which require transmission relay; all other teletype messages must be prepared using form 0-93.
2. Additions such as notes and administrative data for a specific addressee are not allowed. If a note or administrative data is required for a particular addressee a separate 0-73 form must be prepared.
3. The message will be transmitted just as it appears. The person approving the message is solely responsible for assuring all necessary editing changes have been made.

PREPARATION OF FORM WHICH CONSISTS OF A PREPRINTED YELLOW.

1. Complete appropriate boxes: date, classification & precedence.
2. List addresses immediately following the "TO" or place a check mark in the appropriate boxes.
3. Type or PRINT the subject in the space provided.
4. Print or type originator's name, room number and telephone extension.
5. Indicate approval for transmission by initialing the "Approved By" box.

PREPARATION OF MESSAGE TO BE TRANSMITTED

1. Xerox 1 copy of incoming teletype message. A notation shall be made on the original incoming teletype "1 copy made for relay to SACS _____, (OR LEGATS) _____, (OR GOVERNMENT AGENCIES) _____."
2. Minor editing changes shall be made on the xerox as follows: using a lead pencil ONLY draw single line through the first and last lines of the heading and connect these lines from top right to bottom left forming a "Z," figure. (DO NOT OBLITERATE THE HEADING.) Use horizontal lines to delete sentences or words. Printed changes of a word or two to the text of the message may be made; however, changes to the existing text involving more than a word or two necessitate the originator to initiate a new message using form 0-93.
3. Administrative data or notes may be typed immediately following the text and will be transmitted to all addressees.
4. When using the 0-73 form to disseminate information to field offices, Legal Attaches and other Government agencies simultaneously, the text, notes and administrative data must be identical for all addressees.

AX 3-12
NT

001

MESSAGE RELAY VIA TELETYPE

DATE 10/12/79	CLASSIFICATION UNCLAS	PRECEDENCE PRIORITY
------------------	--------------------------	------------------------

FM DIRECTOR FBI

TO

FEDERAL GOVERNMENT

b3
b6
b7C
b7E



(SERVICE ALSO AVAILABLE TO GOVERNMENT AGENCIES NOT LISTED.
CONTACT COMMUNICATIONS CENTER FOR ADDRESSING INFORMATION)

SUBJECT:

VISIT OF PREMIER FIDEL CASTRO TO UN OCTOBER 19, 1979, PFO.

APPROVED BY <i>[Signature]</i>	ORIGINATOR	ROOM 5027	TELE EXT. 2805
-----------------------------------	------------	--------------	-------------------

64 NOV 8 1979

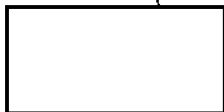

FEDERAL BUREAU OF INVESTIGATION
COMMUNICATIONS SECTION
OCT 13 1979
[Signature]

REC-126

185-1241-21

DO NOT FILE WITHOUT COMMUNICATIONS STAMP

USE OF FORM 0-73

1. Only incoming teletype messages which require transmission relay may be prepared for transmission using form 0-73. Use of form 0-73 is restricted to incoming teletype messages received within the last 3 days which require transmission relay; all other teletype messages must be prepared using form 0-93.
2. Additions such as notes and administrative data for a specific addressee are not allowed. If a note or administrative data is required for a particular addressee a separate 0-73 form must be prepared.
3. The message will be transmitted just as it appears. The person approving the message is solely responsible for assuring all necessary editing changes have been made.

PREPARATION OF FORM WHICH CONSISTS OF A PREPRINTED YELLOW.

1. Complete appropriate boxes: date, classification & precedence.
2. List addresses immediately following the "TO" or place a check mark in the appropriate boxes.
3. Type or PRINT the subject in the space provided.
4. Print or type originator's name, room number and telephone extension.
5. Indicate approval for transmission by initialing the "Approved By" box.

13 OCT 79 00 23
COMMUNICATIONS SECTION
FEDERAL BUREAU OF INVESTIGATION

PREPARATION OF MESSAGE TO BE TRANSMITTED

1. Xerox 1 copy of incoming teletype message. A notation shall be made on the original incoming teletype "1 copy made for relay to SACS _____, (OR LEGATS) _____, (OR GOVERNMENT AGENCIES) _____."
2. Minor editing changes shall be made on the xerox as follows: using a lead pencil ONLY draw single line through the first and last lines of the heading and connect these lines from top right to bottom left forming a "Z," figure. (DO NOT OBLITERATE THE HEADING.) Use horizontal lines to delete sentences or words. Printed changes of a word or two to the text of the message may be made; however, changes to the existing text involving more than a word or two necessitate the originator to initiate a new message using form 0-93.
3. Administrative data or notes may be typed immediately following the text and will be transmitted to all addressees.
4. When using the 0-73 form to disseminate information to field offices, Legal Attaches and other Government agencies simultaneously, the text, notes and administrative data must be identical for all addressees.

AX0003 2852105Z

OO HQ NY

DE AX

O 122030Z OCT 79

RECEIVED
TELETYPE UNIT

12 OCT 79 21 12z

RECEIVED
FEDERAL BUREAU
OF INVESTIGATION
COMMUNICATIONS SECTION

Exec. AD-Inv.	_____
Exec. AD-Adm.	_____
Exec. AD-LES	_____
Asst. Dir.:	
Adm. Servs.	_____
Crim. Inv.	_____
Ident.	_____
Intell.	_____
Laboratory	_____
Legal Coun.	_____
Plan. & Insp.	_____
Rec. Mgnt.	_____
Tech. Servs.	_____
Training	_____
Public Affs. Off.	_____
Telephone Rm.	_____
Director's Sec'y	_____

FM ALEXANDRIA (185-NEW) (P)

TO DIRECTOR ~~IMMEDIATE~~

NEW YORK IMMEDIATE

BT

UNCLAS

CAZVIZ; PFO

~~REAXTEL CALL TO BUREAU, OCTOBER 12, 1979,~~

FBI

ON AFTERNOON OF OCTOBER 12, 1979, ~~SAC CHARLES P. MONROE,~~

~~ALEXANDRIA DIVISION~~ WAS CONTACTED BY A RELIABLE SOURCE WHO STATED

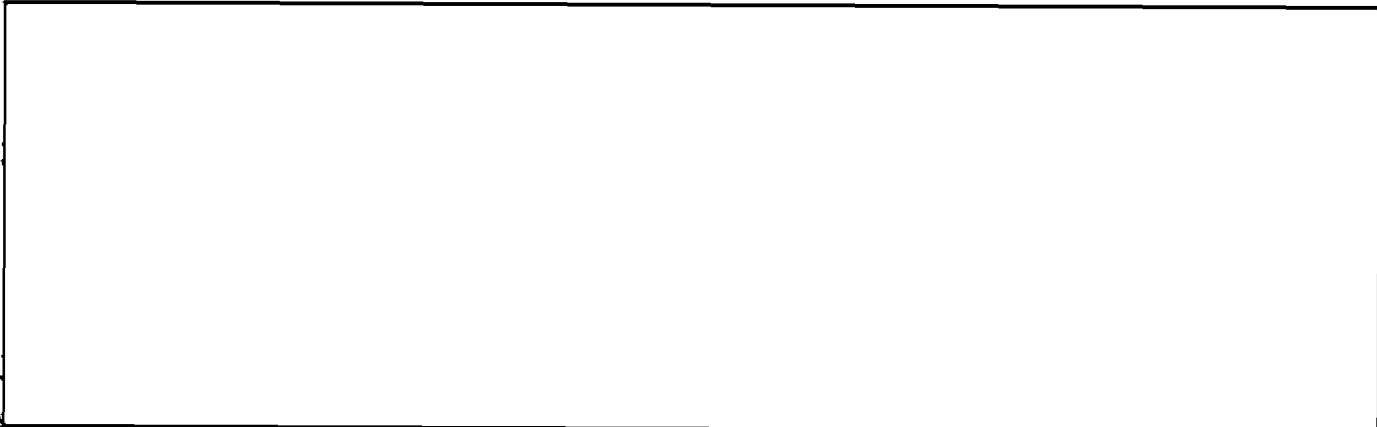

~~ADMINISTRATIVE~~

SOURCE: [redacted]

(PROTECT BY REQUEST), [redacted]

02 15 9:04 PM '79

INVESTIGATIVE
COURTESY
RECEIVED

b7D

b6
b7C
b7D

PAGE TWO AX 185-NEW UNCLAS



b6
b7C
b7D

~~IT IS REQUESTED ANY INFORMATION IN THE POSSESSION OF FBIHQ~~

~~OR NEW YORK VERIFYING~~



~~RE~~

b7D

~~EXPEDITIOUSLY PROVIDED THE ALEXANDRIA DIVISION~~

BT

DEPARTMENT OF JUSTICE
FEDERAL BUREAU OF INVESTIGATION
COMMUNICATION MESSAGE FORM

b6
b7C

PAGE 3 OF 3

DATE 9-20-79 CLASSIFICATION ~~CONFIDENTIAL~~ PRECEDENCE IMMEDIATE

#FB99500 CG LA NK NY SJ WF\$DE HQ H0099 #HBYCS0 202047Z SEP 79

START HERE

FM DIRECTOR FBI
TO FBI LOS ANGELES IMMEDIATE
FBI NEW YORK IMMEDIATE
FBI CHICAGO IMMEDIATE
FBI NEW JERSEY IMMEDIATE
FBI SAN JUAN IMMEDIATE
FBI WASHINGTON FIELD IMMEDIATE

2

NEWARK

BT

~~CONFIDENTIAL~~

PROPOSED VISIT OF CUBAN PREMIER FIDEL CASTRO TO THE UNITED STATES, OCTOBER, 1979; PFO MATTER; OO: NEW YORK;

REFERENCE LOS ANGELES TELETYPE TO FBIHQ DATED

N1

SEPTEMBER 18, 1979, UNDER THE CAPTION

NEW YORK TELETYPE TO FBIHQ DATED SEPTEMBER 19, 1979, AND

NEW YORK TELETYPE TO FBIHQ DATED SEPTEMBER 19, 1979, UNDER

INSTANT CAPTION.

REC 11

LOS ANGELES DIVISION SUTEL RESULTS

DO NOT TYPE MESSAGE BELOW THIS LINE

APPROVED BY <i>JM</i>	DRAFTED BY	DATE 9-20-79	ROOM 4051	TELE EXT. 4632	22 SEP 22 1979
--------------------------	------------	-----------------	--------------	-------------------	----------------

- 1 -
- 1 -
- 1 -
- 1 -
- 1 -
- 1 -

SEE NOTE ON PAGE FOUR

BUREAU OF INVESTIGATION
COMMUNICATIONS SECTION

SEP 20 1979

63 OCT 9 1979

DO NOT FILE WITHOUT COMMUNICATIONS STAMP

DEPARTMENT OF JUSTICE
FEDERAL BUREAU OF INVESTIGATION
COMMUNICATION MESSAGE FORM

PAGE 2

CONTINUATION SHEET

PAGE TWO DE DEH* HQ 0099 ~~C O N F I D E N T I A L~~

REQUESTED OF YOU BY NEW YORK DIVISION IN REFERENCED TELETYPE.

IF THE DESIRED INFORMATION IS NOT OBTAINED THROUGH NORMAL INVESTIGATIVE PROCEDURES, IT IS SUGGESTED THAT SAC, LOS ANGELES PERSONALLY CONTACT THE CHIEF OF POLICE OF THE LOS ANGELES POLICE DEPARTMENT IN ORDER THAT LOS ANGELES POLICE DEPARTMENT SOURCE BE MADE AVAILABLE FOR INTERVIEW BY EXPERIENCED SEASONED FBI AGENTS. THE PROPER ASSESSMENT OF INFORMATION FURNISHED BY THE LOS ANGELES DIVISION IS A MUST, THEREFORE EVERY ASPECT OF IT SHOULD BE THOROUGHLY EXAMINED AND FBIHQ AND FIELD DIVISIONS LISTED IN THIS COMMUNICATION SO ADVISED.

IN THE FUTURE FIELD DIVISIONS RECEIVING A COPY OF THIS COMMUNICATION SHOULD STATE IN AN INCOMING COMMUNICATION CONCERNING SOURCE OR INFORMANT INFORMATION WHAT EFFORTS HAVE BEEN MADE TO CORROBORATE OR REFUTE SAID INFORMATION OR OTHERWISE SET FORTH THE BASIS OF YOUR ASSESSMENT OF THE INFORMATION FURNISHED.

THE NEW YORK DIVISION WILL COORDINATE WITH FBIHQ ON A DAILY BASIS INFORMATION IT INTENDS TO DISSEMINATE TO OTHER FEDERAL AGENCIES OR LOCAL LAW ENFORCEMENT IN ORDER

DO NOT TYPE MESSAGE BELOW THIS LINE

DO NOT TYPE PAST THIS LINE

b7D

DEPARTMENT OF JUSTICE
FEDERAL BUREAU OF INVESTIGATION
COMMUNICATION MESSAGE FORM

PAGE 3

CONTINUATION SHEET

~~PAGE THREE DE HQ 0099 CONFIDENTIAL~~

THAT APPROPRIATE SIMILAR DISSEMINATION CAN BE MADE AT
HEADQUARTERS LEVEL.

~~C AND E BY 3324, REASON 2, DRD SEPTEMBER 20, 1999.~~

BT

z

DO NOT TYPE PAST THIS LINE

DO NOT TYPE MESSAGE BELOW THIS LINE

NOTE: LOS ANGELES DIVISION IN REFERENCED TELETYPE DATED 9-18-79, ADVISED THAT A LOS ANGELES POLICE DEPARTMENT (LAPD) SOURCE, [REDACTED] INDICATED [REDACTED]

[REDACTED] THE LOS ANGELES TELETYPE DOES NOT ATTEMPT TO REFUTE, CORROBORATE OR ASSESS THE INFORMATION PROVIDED BY LAPD SOURCE [REDACTED]

[REDACTED]

THE NEW YORK DIVISION, IN REFERENCED 9-19-79 TELETYPE, ASSUMED ORIGIN IN INSTANT MATTER AND INSTRUCTED ALL FIELD DIVISIONS CONCERNED THAT INFORMATION CONCERNING CASTRO'S VISIT SHOULD BE IN A FORM SUITABLE FOR DISSEMINATION UNDER ABOVE CAPTION AND SAID DISSEMINATION CONCERNING ALLEGED CUBAN EXILE PLOTS TO USSS, DEPARTMENT OF STATE AND THE NEW YORK CITY POLICE DEPARTMENT WILL BE CONTROLLED BY THE NEW YORK DIVISION INDICATING THAT UNSUBSTANTIATED ALLEGATIONS AND RUMOR WILL NOT BE DISSEMINATED. NEW YORK HAS BEEN INSTRUCTED TO COORDINATE ALL DISSEMINATION WITH FBIHQ. NEW YORK ALSO AT THIS TIME HAS ANALYZED INFORMANT INFORMATION REGARDING ALLEGED CONTEMPLATED ACTS AGAINST CASTRO AND VIEWS THE [REDACTED]

[REDACTED] IT SHOULD BE NOTED [REDACTED]

[REDACTED]

b7D

b6
b7C
b7D

OO RI CG LA MM NK NY WF

DE SJ 0002

02021087 SEP 79

FM SAN JUAN (185-70) (P)

TO DIRECTOR IMMEDIATE

CHICAGO IMMEDIATE [redacted]

LOS ANGELES IMMEDIATE

MIAMI IMMEDIATE

NEWARK IMMEDIATE

NEW YORK IMMEDIATE

WASHINGTON FIELD IMMEDIATE

BT

~~SECRET~~

~~SECTION 1.5 OF 2~~

PROPOSED VISIT OF CUBAN PREMIER FIDEL CASTRO TO THE UNITED

STATES, OCTOBER, 1979; PFO MATTER, (OO: NEW YORK)

REFERENCE NEW YORK TELETYPE, SEPTEMBER 19, 1979; SAN

JUAN TELETYPE, SEPTEMBER 17, 1979, ENTITLED [redacted]

[redacted] AND [redacted] RICO", NO COPY TO

CHICAGO, LOS ANGELES, WASHINGTON FIELD; MIAMI TELETYPES,

RECEIVED
TELETYPE UNIT

20 SEP 79 21 47z

RECEIVED
FEDERAL BUREAU
OF INVESTIGATION
COMMUNICATIONS SECTION

Exec. AD-Adm.	
Exec. AD-Inv.	
Exec. AD-LES	
Asst. Dir.:	
A	
C	
M	
Intel.	
Laboratory	
Legal Coun.	
Plan. & Insp.	
Rec. Mgnt.	
Tech. Servs.	
Training	
Public Affs. Off.	
Telephone Rm.	
Director's Sec'y	

b6
b7C

b3
b6
b7C
b7E

b3
b6
b7C
b7E

*Disseminated to
Acc attached TT*

U.S. DEPT. OF JUSTICE

TELETYPE TO: [redacted]

64 OCT 3 1979

20

185-1241-24

6 OCT 15 1979

b6
b7C

SEPTEMBER 10, 1979 AND SEPTEMBER 5, 1979, ENTITLED [REDACTED]
[REDACTED], NO COPY TO
NEWARK, CHICAGO, LOS ANGELES, AND WASHINGTON FIELD.

b3
b6
b7C
b7E

THE FOLLOWING INFORMATION IS PROVIDED REGARDING A PLOT
AGAINST FIDEL CASTRO DURING HIS PROPOSED VISIT TO THE
UNITED NATIONS. THE INFORMATION WAS PROVIDED BY [REDACTED]
WHO HAS PROVIDED RELIABLE INFORMATION CONCERNING ANTI-CASTRO
TERRORIST ACTIVITIES ON NUMEROUS OCCASIONS IN THE PAST. THE
INFORMATION IS SINGULAR IN NATURE AND IS NOT TO BE DISSEMINATED
OUTSIDE OF THE FBI IN ORDER TO PROTECT THE IDENTITY OF AN
EXTREMELY VALUABLE ASSET AND TO PROTECT A VERY SENSITIVE

b3
b7D

[REDACTED]
[REDACTED] (~~CS~~) (U)

b3
b7D

AT THIS POINT, THE PLOT IS IN ITS EMBRYONIC STAGES,
IT IS NOT KNOWN IF IT WILL BE DEVELOPED FURTHER, AND TO
DISSEMINATE ANY INFORMATION CONCERNING IT AT THIS TIME
WOULD BE PREMATURE. IT IS POINTED OUT THE INFORMATION
FURNISHED BY THE ASSET [REDACTED]

b3
b7D

[REDACTED] SHOULD ANY
U.S. AGENCY, WHETHER INTENTIONALLY OR NOT, PASS INFORMATION
REGARDING THIS PLOT [REDACTED]
ITS ORIGIN WOULD BE OBVIOUS AND THE ASSET WOULD BE
COMPROMISED. ~~(S)~~ (U)

ON AUGUST 27, 1979, THE ASSET TELEPHONICALLY CONTACTED

[REDACTED]

[REDACTED]

~~(S)~~ (U)

ON AUGUST 30, 1979, [REDACTED]

[REDACTED]

b3
b7D

b3
b6
b7C
b7D

b3
b6
b7C
b7D

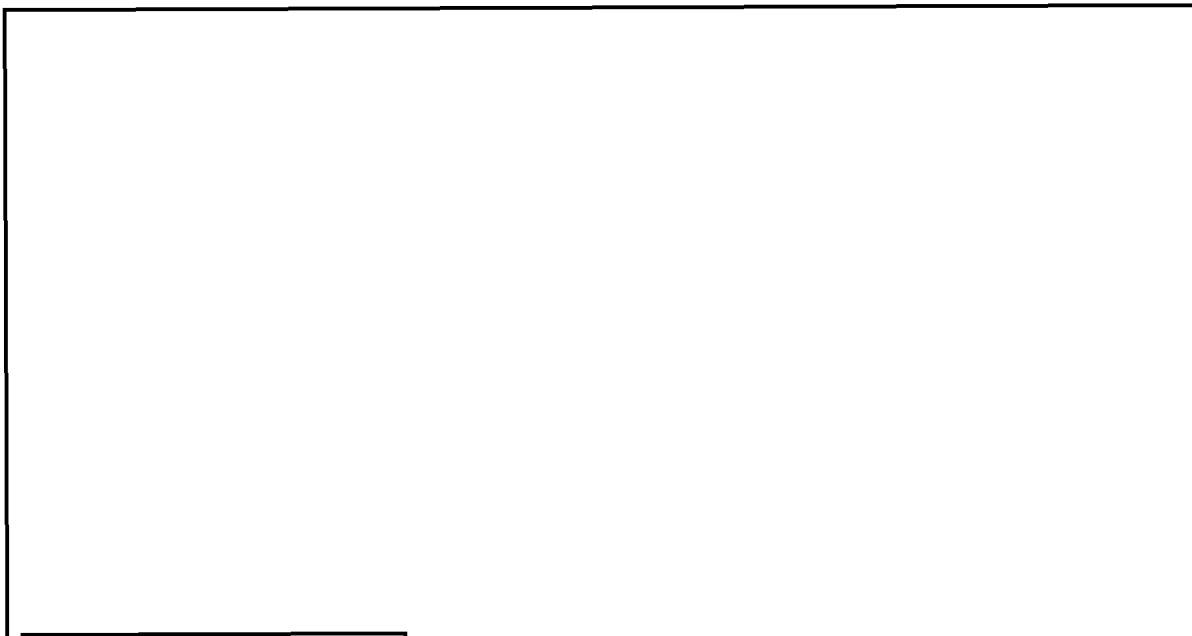

b3
b6
b7C
b7D



~~(S)~~ (U)

SAN JUAN HAS NO INFORMATION REGARDING A PLOT INVOLVING

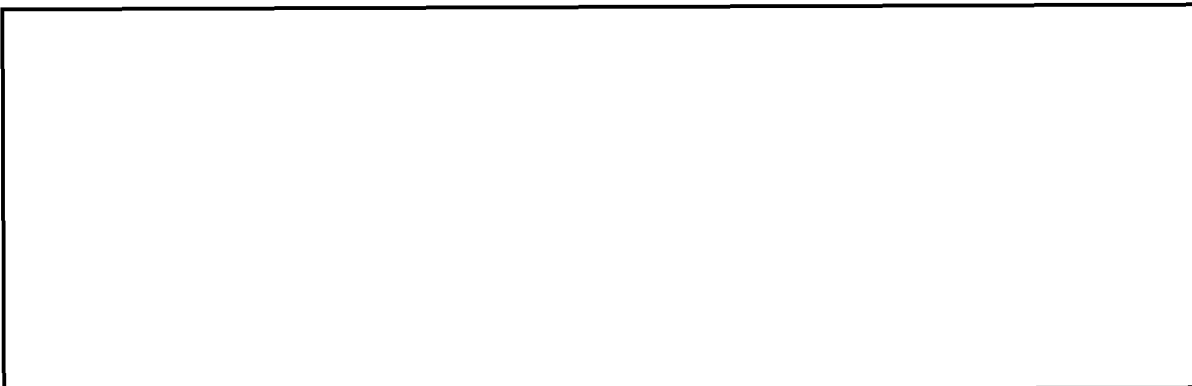

b3
b6
b7C
b7D

IT IS KNOWN BOTH [REDACTED]

[REDACTED]

MUST OBTAIN PERMISSION TO TRAVEL. SAN JUAN SUGGESTS THAT MIAMI ENSURE THAT PERMISSION IS NOT GIVEN FOR ANY OF THESE INDIVIDUALS TO TRAVEL TO NEW YORK. THEN, IF THEY DO GO,

b6
b7C

[REDACTED] (S) (U)

FOR THE INFORMATION OF NEW YORK, SAN JUAN HAS AN UP TO DATE PHOTO ALBUM OF CUBAN EXILE TERRORISTS WHICH WILL BE FORWARDED TO NEW YORK UPON REQUEST. A COPY OF THIS ALBUM HAS BEEN PROVIDED SECRET SERVICE LOCALLY IN ANTICIPATION OF CASTRO'S VISIT. SAN JUAN HAS ALSO TARGETED ITS SOURCES TO OBTAIN INFORMATION CONCERNING THIS MATTER. SAN JUAN WILL CONTINUE TO EXPEDITIOUSLY FORWARD INFORMATION IN THIS MATTER TO INTERESTED OFFICES UNDER ABOVE CAPTION. SAN JUAN DID NOT USE THIS CAPTION BEFORE AS NEW YORK HAD NOT PREVIOUSLY PROVIDED ANY DIRECTION IN THIS MATTER. NEW YORK IS DIRECTED TO REFERENCED MIAMI TELETYPES FOR A MORE DETAILED ACCOUNT OF [REDACTED] SAN JUAN IS NOT SETTING FORTH THIS INFORMATION HERE BECAUSE NEW YORK IS ALREADY IN RECEIPT OF MIAMI'S TELETYPES, AND TO PROVIDE IT HERE WOULD

b3
b6
b7C
b7D

ONLY BE A DUPLICATION OF EFFORT. SAN JUAN PLANS TO [REDACTED]

[REDACTED]

[REDACTED]

[REDACTED] (~~S~~) (U)

THE ONLY INFORMATION AVAILABLE AT SAN JUAN CONCERNING
CASTRO'S VISIT IS THAT PROVIDED BY [REDACTED]

IN ORDER TO MAKE INTELLIGENT DECISIONS IN THIS MATTER, IT IS
NECESSARY THAT APPROPRIATE INFORMATION BE MADE AVAILABLE.

THEREFORE, NEW YORK WILL IMMEDIATELY ADVISE ALL INTERESTED
OFFICES OF ANY PLANS CASTRO HAS TO VISIT NEW YORK, PARTICULARLY
THE DATES OF HIS VISIT. (~~S~~) (U)

C AND E, 8024, REASONS (2) AND (3), DRD SEPTEMBER 20, 1999.

BT

b3
b6
b7C
b7D

b3
b6
b7C
b7D

142

DEPARTMENT OF JUSTICE
FEDERAL BUREAU OF INVESTIGATION
COMMUNICATION MESSAGE FORM

b6
b7c

PAGE 2 OF 2

DATE 9-21-79 CLASSIFICATION UNCLAS E F T O PRECEDENCE PRIORITY

\$\$\$PP Y16\$Y23_H0142_2650100\$YESP_212225Z_SEP_79

START HERE

FM DIRECTOR FBI FEDERAL GOVERNMENT

TO U.S. SECRET SERVICE (PID)

BT

UNCLAS E F T O

POSSIBLE TERRORIST ACTIVITY IN CONNECTION WITH THE VISIT OF
PREMIER FIDEL CASTRO OF CUBA TO THE UNITED STATES.

REFERENCE YOUR TELETYPE TO THE DIRECTOR OF THE FBI DATED
SEPTEMBER 18, 1979.

CONSISTENT WITH THE FBI'S RESPONSIBILITIES IN REGARD TO
THE PROTECTION OF FOREIGN OFFICIALS ACT AND THE RESPONSIBILITY
OF TERRORIST ACTS AGAINST PREMIER FIDEL CASTRO OF CUBA WHO
MAY VISIT THE UNITED NATIONS IN OCTOBER, 1979, FBIHQ CONCURS
WITH YOUR RECOMMENDATION OF JOINT FBI - USSS INTERVIEWS OF
PERSONS UPON WHOM IT IS AGREED BETWEEN FBIHQ AND USSS PRESENTS
A DANGER TO CASTRO DURING HIS VISIT TO THE UNITED STATES.

THESE JOINT INVESTIGATIONS WILL BE CONTINGENT UPON THE

FOLLOWING POINTS:

DO NOT TYPE MESSAGE BELOW THIS LINE

APPROVED [] DRAFTED BY [] DATE 9-21-79 ROOM 4051 TELE EXT. 4632

- 1 - []
- 1 - []
- 1 - []
- 1 - []
- 1 - []
- 1 - []

SEE NOTE ON PAGE THREE

[]

FEDERAL BUREAU OF INVESTIGATION
COMMUNICATIONS SECTION

SEP 22 1979

60 OCT 2 1979

DO NOT FILE WITHOUT COMMUNICATIONS STAMP

OT TYPE PAST THIS LINE

b3
b6
b7c
b7E

b6
b7c

DEPARTMENT OF JUSTICE
FEDERAL BUREAU OF INVESTIGATION
COMMUNICATION MESSAGE FORM

PAGE 2

CONTINUATION SHEET

PAGERTWOEDE HQ 0142 UNCLAS E F T O

1. FBIHQ BE ADVISED IN WRITING OF THE IDENTITIES OF PERSONS DESIRED TO BE INTERVIEWED, THEIR ADDRESS AND OCCUPATION.

2. THE NATURE OF THE INFORMATION WHICH PREDICATES THIS INTERVIEW.

3. THE INTERVIEWS BE CONDUCTED UPON THE AUTHORIZATION OF THE SPECIAL AGENT IN CHARGE OF THE FBI FIELD OFFICE IN WHICH THE INTERVIEW IS CONTEMPLATED, CONSISTENT WITH HIS INVESTIGATIVE PRIORITIES AND MAN POWER.

4. NO INTERVIEWS WILL BE CONDUCTED WHICH MAY JEOPARDIZE CURRENT INVESTIGATION.

YOUR RESPONSE TO THE ABOVE POINTS IS DESIRED BEFORE A COMMUNICATION IS DIRECTED FROM FBIHQ TO THE AFFECTED FBI FIELD DIVISIONS.

BT

†

DO NOT TYPE PAST THIS LINE

DO NOT TYPE MESSAGE BELOW THIS LINE

NOTE: ON 9-14-79, USSS SPECIAL AGENTS [REDACTED] ATTENDED A CONFERENCE AT FBIHQ WITH SUPERVISORS [REDACTED] OF DIVISION 5, AND [REDACTED] OF THE TERRORISM SECTION, DIVISION 6. THE PURPOSE OF THE USSS REQUESTED CONFERENCE WAS DETERMINED TO BE CUBAN ANTI-CASTRO TERRORISTS AND THE POSSIBLE VISIT TO THE UNITED NATIONS IN NEW YORK CITY IN OCTOBER, 1979, BY PREMIER FIDEL CASTRO OF CUBA. [REDACTED] INDICATED [REDACTED]

b6
b7C
b7E

[REDACTED] THEY FURTHER INDICATED THEY HAD APPROXIMATELY 72 INDIVIDUALS THEY ARE INTERESTED IN INTERVIEWING REGARDING CASTRO'S VISIT WHOSE IDENTITIES THEY DETERMINED THROUGH FBI INFORMATION. THEY REQUESTED FBI AGENTS TO ASSIST IN THESE INTERVIEWS SINCE THEY DID NOT HAVE ENOUGH AGENTS IN THE FIELD TO ACCOMPLISH THESE INTERVIEWS IN THE TIME REMAINING BEFORE THE VISIT OF CASTRO IN OCTOBER. THEY WERE ADVISED ANY FBI JOINT INTERVIEWS MUST BE PREDICATED UPON WRITTEN REQUEST FROM THE DIRECTOR OF USSS TO THE DIRECTOR OF THE FBI. REFERENCE USSS TELETYPE IS THE RESULT OF THAT CONFERENCE. IF THIS TELETYPE TO USSS IS APPROVED, AN APPROPRIATE TELETYPE WILL BE DIRECTED TO THE FIELD DIVISIONS AFFECTED.

APPROVED:

[REDACTED]

Director _____
Exec. AD-Adm. _____
Exec. AD-Inv. _____
Exec. AD-LES _____

Adm. Serv. _____
Crim. Inv. _____
Ident. _____
Intell. _____
Laboratory _____

Legal Coun. _____
Plan. & Insp. _____
Rec. Mgnt. _____
Tech. Servs. _____
Training _____
Public Affs. Off. _____

b6
b7C

LA0629 2652355Z

PP HQ NY

DE LA 6

222355Z SEP 79R

FM LOS ANGELES (185-NEW) (3) (P)

TO DIRECTOR PRIORITY

NEW YORK PRIORITY

BT

~~CONFIDENTIAL~~

PROPOSED VISIT OF CUBAN PREMIER FIDEL CASTRO TO UNITED STATES,
OCTOBER 1979, PFO.

RE LOS ANGELES TELETYPE DATED SEPTEMBER 17, 1979,
CAPTIONED, [redacted] AND NEW YORK TELYTYPES
DATED SEPTEMBER 18, 1979 AND SEPTEMBER 19, 1979, CAPTIONED
AS ABOVE.

ON SEPTEMBER 18, 1979, LOS ANGELES DIVISION MET WITH
PUBLIC DISORDER AND INTELLIGENCE DIVISION (PDID), LOS ANGELES
POLICE DEPARTMENT (LAPD), TO CLARIFY INFORMATION REPORTED IN
REFERENCED LOS ANGELES TELETYPE. THE FOLLOWING WAS DETERMINED
AS A RESULT OF THIS MEETING: ~~(S)~~ (U)

THE SOURCE OF PDID'S INFORMATION IS CONSIDERED BY THEM
TO BE RELIABLE AND IN A POSITION TO RECEIVE SUCH INFORMATION,

RECEIVED
TELETYPE UNIT

27 SEP 79 00 26z

RECEIVED
FEDERAL BUREAU
OF INVESTIGATION
COMMUNICATIONS SECTION

Exec. AD-Adm.	b6
Exec. AD-Inv.	b7C
Exec. AD-LES	
Asst. Dir.:	
Adm. Serv.	[redacted]
Crim. Inv.	
Ident.	
Insp.	
Laboratory	
Legal Coun.	
Plan. & Insp.	
Rec. Mgmt.	
Tech. Servs.	
Training	
Public Aff. Off.	
Telephone Rm.	
Director's Sec'y	

b3
b7E

185-1241-26

REC-70

EX-109

16 OCT 2 1979

63 OCT 29 1979

b6
b7C

b3
b7E

b6
b7C

PAGE TWO (LA 185-NEW) ~~C O N F I D E N T I A L~~

HOWEVER, [REDACTED]

b7D

(IN RESPONSE TO QUESTION NUMBER 1 IN REFERENCED TELETYPE, FBI, LOS ANGELES, DID NOT ASK, "WHAT TYPE OF INFORMATION SOURCE HAD PROVIDED TO ESTABLISH HIS RELIABILITY.") ~~(S)~~ (U)

PDID WOULD NOT DISCLOSE [REDACTED]

[REDACTED] HOWEVER, FBI, LOS ANGELES, RECEIVED THE IMPRESSION THAT [REDACTED]

b7D

[REDACTED]

WHEN THE SUBJECT OF FBI ACCESS TO THIS SOURCE WAS DISCREETLY APPROACHED, PDID POLITELY DECLINED TO FURNISH SUCH ACCESS. AS CERTAINLY FBIHQ IS AWARE, THE CONFIDENTIALITY OF SOURCES IS AN EXTREMELY SENSITIVE AREA IN ALL LAW ENFORCEMENT AGENCIES, INCLUDING THE FBI, AND IT IS LOS ANGELES' OPINION THAT FURTHER ATTEMPTS TO GAIN DIRECT ACCESS TO THIS SOURCE OF THE LAPD WOULD ONLY SERVE TO DAMAGE AN EXCELLENT WORKING RELATIONSHIP LOS ANGELES ENJOYS WITH THAT AGENCY. THE REPRESENTATIVES OF PDID WHO ARE HANDLING THIS SOURCE ARE WELL EXPERIENCED AND HIGHLY COMPETENT. THEY ARE ALSO FULLY AWARE OF THE NECESSITY OF OBTAINING ALL PERTINENT DETAILS BUT AT THIS POINT HAVE NO FURTHER DETAILS CONCERNING PERSONS OR

GROUPS INVOLVED, NOR DATE, TIME, OR PLACE OF ANY ACTION. PDID EXPECTS THAT THEIR SOURCE SHOULD BE RECEIVING ADDITIONAL INFORMATION AS PLANS ARE FINALIZED, AND THEY WILL KEEP THE FBI ADVISED OF ALL INFORMATION THEY RECEIVE IN THIS MATTER ON A TIMELY BASIS. ~~(S)~~ (U)

PDID ADVISED THAT

[Redacted]

[Redacted]

b7D

IT IS NOTED THAT PDID HAS PROVIDED THE SAME INFORMATION (AS REPORTED IN REFERENCED LOS ANGELES TELETYPE) TO LOCAL SECRET SERVICE REPRESENTATIVES. ~~(S)~~ (U)

NEW YORK IS REQUESTED TO FURNISH NAME AND NUMBER OF INDIVIDUAL TO BE CONTACTED BY ABOVE SOURCE REGARDING ANY INFORMATION SOURCE HAS AFTER ARRIVAL IN NEW YORK CONCERNING PLANNED ACTION AGAINST CASTRO. NEW YORK WILL BE ADVISED OF CODE NAME TO BE USED BY SOURCE FOR SUCH CONTACT. ~~(S)~~ (U)

Why didn't they make this in LA TT dated 9/19/79?

C AND E 9231, REASON (2 AND 3), DDD SEPTEMBER 21, 1979.

BT

#

Exec. AD-Adm.	
Exec. AD-Inv.	
Exec. AD-LES	
Asst. Dir.:	
Adm.	
Crim.	
Ident.	
Intell.	
Laboratory	
Legal Coun.	
Plan. & Insp.	
Rec. Mgnt.	
Tech. Servs.	
Training	
Public Affs. Off.	
Telephone Rm.	
Director's Sec'y	

b6
b7C

RECEIVED
TELETYPE UNIT

25 SEP 79 22 58z

RECEIVED
FEDERAL BUREAU
OF INVESTIGATION
COMMUNICATIONS SECTION

NK0017 2682230
 OO HI LA MM NY SJ WF
 DE NK 017
 O 252230Z SEP 79
 FM NEWARK (185-122) (P) (C-3)
 TO DIRECTOR (IMMEDIATE)
 LOS ANGELES (IMMEDIATE)
 MIAMI (IMMEDIATE)
 NEW YORK (IMMEDIATE)
 SAN JUAN (VIA FBIHQ) (IMMEDIATE)
 WFO (IMMEDIATE)

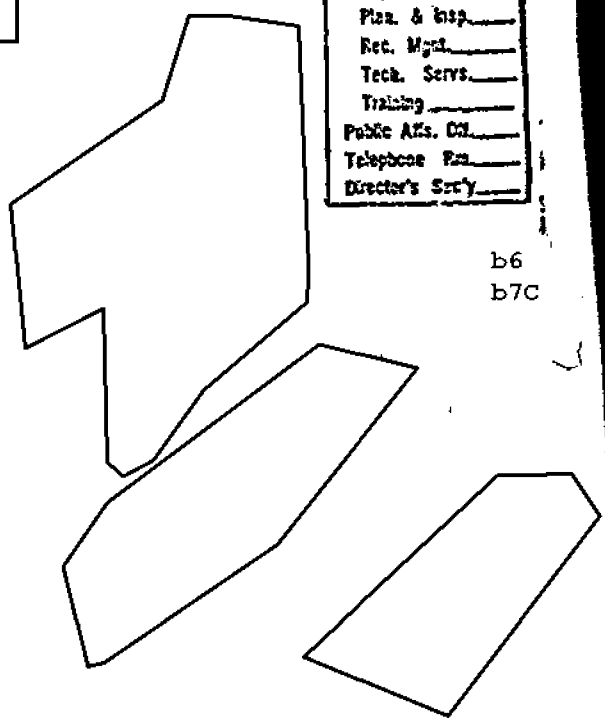

b6
b7C

BT

~~SECRET~~

PROPOSED VISIT OF CUBAN PREMIER FIDEL CASTRO TO THE UNITED STATES
 OCTOBER 5, 1979; PFO MATTER (OO: NY)

REC-81 185-1241-28

RE SAN JUAN TELETYPE TO BUREAU, SEPTEMBER 20, 1979



ON SEPTEMBER 25, 1979, [redacted] A SOURCE WHO HAS PROVIDED

RELIABLE INFORMATION IN THE PAST, ADVISED AS FOLLOWS:

22 SEP 28 1979

b3
b6
b7C
b7D
b7E



25 52
 INADVISABLE
 60
 2 1979

TT
 USSS
 PMA
 DOS
 EPZ
 [redacted]

b3
b6
b7C
b7E

[REDACTED]

b6
b7C
b7D

[REDACTED]

b6
b7C
b7D

[REDACTED]

b6
b7C
b7D

ON SEPTEMBER 25, 1979, [REDACTED], WHO HAS PROVIDED

RELIABLE INFORMATION IN THE PAST, ADVISED [REDACTED]

b6
b7C
b7D

[REDACTED]



b6
b7C
b7D

A D M I N I S T R A T I V E

[REDACTED] WAS EXTENSIVELY QUERIED IN REGARD TO [REDACTED]

[REDACTED]

SOURCE COULD NOT

PROVIDE ANY ADDITIONAL DETAILS, BUT MADE THE FOLLOWING OBSERVATIONS.

b6
b7C
b7D



PAGE FOUR, NEWARK 185-122, ~~SECRET~~

b6
b7C
b7D

NEWARK ADDITIONALLY NOTES THAT IN REFERENCED TELETYPE,
SAN JUAN DEVELOPED INFORMATION THROUGH A WELL PLACED SOURCE
THAT [REDACTED]

b6
b7C
b7D

[REDACTED] NEWARK IS REQUESTING SAN
JUAN TO COMMENT ON THE FEASIBILITY OF [REDACTED]

~~(C AND E 953, REASONS 2 AND 3, DRD SEPTEMBER 25, 1999.)~~

BT

#

FBI

TRANSMIT VIA:

- Teletype
- Facsimile
- AIRTEL

PRECEDENCE:

- Immediate
- Priority
- Routine

CLASSIFICATION:

- TOP SECRET
- SECRET
- CONFIDENTIAL
- UNCLAS E F T O
- UNCLAS

Date 9/25/79

TO: DIRECTOR, FBI

~~CONFIDENTIAL~~

FROM: SAC, SAN JUAN (185-70) (P)

TR5
SUBJECT: PROPOSED VISIT OF CUBAN PREMIER FIDEL CASTRO TO THE UNITED STATES, OCTOBER, 1979;
 PFO
 (OO:NY)

Re New York teletype, 9/22/79.

Enclosed for New York is San Juan's Cuban Exile Terrorist Album.

San Juan does not have copies of all photographs contained in the Album. Therefore, San Juan is forwarding its only copy of this Album. Because San Juan's photographic laboratory is limited, New York is requested to make copies of the album as needed and return the original to San Juan.

REC-65

EX-109

185-1241-29
1 OCT 9 1979

~~CONFIDENTIAL~~

- Bureau
- 2- New York (Encl. 1) (185-) (M-10)
- 1- San Juan

[redacted]

(5)

Classified and Extended by BOA
 Reason for Extension FCIM, II, 1-2.4.2 2E2
 Date of Review for Declassification 9/25/99

Approved: 63 OCT 29 1979 Transmitted _____ (Number) _____ (Time) Per _____

DEPARTMENT OF JUSTICE
FEDERAL BUREAU OF INVESTIGATION
COMMUNICATION MESSAGE FORM

b6
b7c

006

1 OF 3

DATE 9-25-79 CLASSIFICATION UNCLAS E F T O PRECEDENCE PRIORITY

*FOO6\$PP LA MM NK NY SJ WFSDE HQ H0006 \$H3YESP 260054Z SEP 79

START HERE

FM DIRECTOR FBI
TO FBI LOS ANGELES PRIORITY
FBI NEWARK PRIORITY
FBI NEW YORK PRIORITY
FBI MIAMI PRIORITY
FBI SAN JUAN PRIORITY
FBI WASHINGTON FIELD PRIORITY

2

BT
UNCLAS E F T O

PROPOSED VISIT OF CUBAN PREMIER FIDEL CASTRO TO THE UNITED STATES, OCTOBER, 1979; PFO MATTER; OO: NEW YORK.

REFERENCE FBIHQ TELETYPE TO LOS ANGELES DATED SEPTEMBER 20, 1979.

THE UNITED STATES SECRET SERVICE (USSS), BY TELETYPE DATED SEPTEMBER 18, 1979, RECOMMENDED FBI-USSS JOINT INTERVIEWS OF CUBAN EXILE ANTI-CASTRO PERSONS IN CONNECTION WITH THE VISIT OF PREMIER FIDEL CASTRO OF CUBA WHO MAY VISIT THE UNITED NATIONS

DO NOT TYPE MESSAGE BELOW THIS LINE

185-1241-30

APPROVED BY [redacted] DRAFTED BY [redacted] DATE EX-125 ROOM 4853 TELE EXT. [redacted]

- 1 - [redacted] SEE NOTE ON PAGE 1
- 1 - [redacted]
- 1 - [redacted]
- 1 - [redacted]
- 1 - [redacted]
- 1 - [redacted]

22 SEP 28 1979

b3
b6
b7c
b7E

63 OCT 26 1979

FEDERAL BUREAU OF INVESTIGATION
COMMUNICATIONS SECTION
0834
SEP 26 1979

DO NOT TYPE PAST THIS LINE

DEPARTMENT OF JUSTICE
FEDERAL BUREAU OF INVESTIGATION
COMMUNICATION MESSAGE FORM

PAGE

2

CONTINUATION SHEET

PAGERITMOE DE HQ 0006 UNCLAS E F T O

IN NEW YORK CITY, DURING THE FIRST WEEK OF OCTOBER, 1979.

20 FBIHQ CONCURS WITH USSS RECOMMENDATION OF JOINT FBI-USSS
18 INTERVIEWS OF PERSONS UPON WHOM IT IS AGREED BETWEEN FBI AND
16 USSS, PRESENT A DANGER TO CASTRO DURING HIS VISIT TO THE
UNITED STATES. THESE JOINT INVESTIGATIONS WILL BE CONTINGENT
UPON THE FOLLOWING POINTS:

14 1. FBIHQ BE ADVISED IN WRITING OF THE IDENTITIES OF
12 PERSONS DESIRED TO BE INTERVIEWED, THEIR ADDRESS AND
OCCUPATION.

10 2. THE NATURE OF THE INFORMATION WHICH PREDICATES THIS
INTERVIEW.

8 3. THE INTERVIEWS BE CONDUCTED UPON THE AUTHORIZATION OF
THE SPECIAL AGENT IN CHARGE OF THE FBI FIELD OFFICE IN WHICH
THE INTERVIEW IS CONTEMPLATED, CONSISTENT WITH HIS
6 INVESTIGATIVE PRIORITIES AND MAN POWER.

4 4. NO INTERVIEWS WILL BE CONDUCTED WHICH MAY JEOPARDIZE
CURRENT INVESTIGATION.

2 OFFICES RECEIVING A COPY OF THIS COMMUNICATION WILL BE
CONTACTED BY USSS AGENTS REQUESTING INTELLIGENCE UPDATES
REGARDING SPECIFIC PERSONS AND DISCUSSION WITH FBI AGENTS OF

DO NOT TYPE MESSAGE BELOW THIS LINE

DO NOT TYPE PAST THIS LINE

DEPARTMENT OF JUSTICE
FEDERAL BUREAU OF INVESTIGATION
COMMUNICATION MESSAGE FORM

PAGE 3

CONTINUATION SHEET

PAGER THREE DE HQ 0006 UNCLAS E F T O

POSSIBLE PERSONS TO BE THE SUBJECT OF A JOINT FBI-USSS

INTERVIEW. AS OF THIS TIME, NO OFFICIAL NOTIFICATION HAS BEEN

RECEIVED BY USSS OF CASTRO'S CONTEMPLATED VISIT TO THE

UNITED NATIONS IN NEW YORK CITY. USSS HAS INSTRUCTED THEIR

AGENTS TO CONDUCT NO INTERVIEWS UNTIL SUCH OFFICIAL NOTIFICATION

IS RECEIVED.

ALL OFFICES ARE INSTRUCTED TO ADVISE NEW YORK FIELD OFFICE,

OTHER INTERESTED DIVISIONS AND FBIHQ OF THE RESULTS OF ANY

SUCH JOINT INTERVIEWS CONDUCTED REGARDING THE CASTRO VISIT.

BT

†

DO NOT TYPE PAST THIS LINE

DO NOT TYPE MESSAGE BELOW THIS LINE

NOTE: USSS HEADQUARTERS, BY TELETYPE, REQUESTED FBI AGENT ASSISTANCE IN JOINT INTERVIEWS OF PERSONS THEY BELIEVE CONSTITUTE A DANGER TO FIDEL CASTRO SHOULD HE VISIT THE UNITED NATIONS IN NEW YORK IN OCTOBER. FBIHQ RESPONDED TO USSS HEADQUARTERS BY TELETYPE DATED 9-20-79, SETTING FORTH CRITERIA UNDER WHICH AUTHORIZATION OF SUCH JOINT INVESTIGATION WILL BE CONDUCTED. USSS, BY TELETYPE DATED 9-24-79, CONCURRED WITH THE CONDITIONS SET FORTH IN REFERENCED BU TELETYPE TO USSS AND ADVISED NO OFFICIAL NOTIFICATION HAS BEEN RECEIVED FROM STATE DEPARTMENT REGARDING CASTRO'S CONTEMPLATED VISIT TO THE UNITED STATES.



APPROVED:

Director _____
 Exec. AD-Adm. _____
 Exec. AD-Inv. _____
 Exec. AD-LES _____

Adm. Serv. _____
 Crim. Inv. _____
 Ident. _____
 Intel _____
 Laboratory _____
 Legal Coun. _____
 Plan. & Insp. _____
 Rec. Mgnt. _____
 Tech. Servs _____
 Training _____
 Public Affs. Off. _____

b6
 b7c

O
A
P



MESSAGE RELAY VIA TELETYPE

110

DATE 9/26/79	CLASSIFICATION SECRET	PRECEDENCE Priority
-----------------	-------------------------------------	------------------------

FM DIRECTOR FBI

TO

FEDERAL GOVERNMENT

b3
b6
b7C
b7E

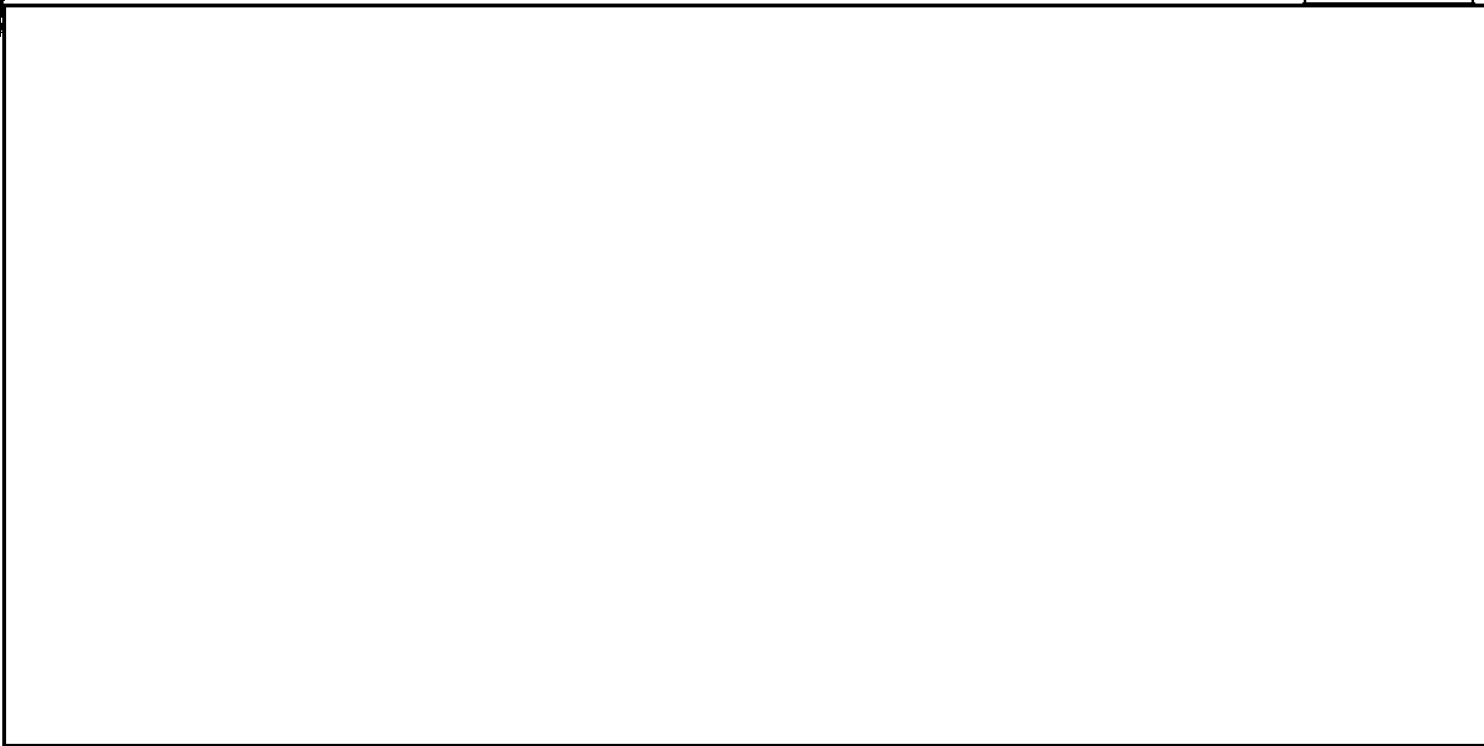
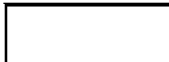

(SERVICE ALSO AVAILABLE TO GOVERNMENT AGENCIES NOT LISTED.
CONTACT COMMUNICATIONS CENTER FOR ADDRESSING INFORMATION)
SUBJECT:

REC-5T 185-7241-31

ST-130

22 SEP 28 1979

APPROVED BY [Signature]	ORIGINATOR [redacted]	ROOM 4048	TELE EXT.
----------------------------	--------------------------	--------------	-----------

b3
b6
b7C
b7E

60 OCT 12 1979

0149
SEP 27 1979

DO NOT FILE WITHOUT COMMUNICATIONS STAMP

USE OF FORM 0-73

1. Only incoming teletype messages which require transmission relay may be prepared for transmission using form 0-73. Use of form 0-73 is restricted to incoming teletype messages received within the last 3 days which require transmission relay; all other teletype messages must be prepared using form 0-93.
2. Additions such as notes and administrative data for a specific addressee are not allowed. If a note or administrative data is required for a particular addressee a separate 0-73 form must be prepared.
3. The message will be transmitted just as it appears. The person approving the message is solely responsible for assuring all necessary editing changes have been made.

PREPARATION OF FORM WHICH CONSISTS OF A PREPRINTED YELLOW ⁵⁶¹ 7

1. Complete appropriate boxes: date, classification & precedence.
2. List addresses immediately following the "TO" or place a check mark in the appropriate boxes.
3. Type or PRINT the subject in the space provided.
4. Print or type originator's name, room number and telephone extension.
5. Indicate approval for transmission by initialing the "Approved By" box.

PREPARATION OF MESSAGE TO BE TRANSMITTED

1. Xerox 1 copy of incoming teletype message. A notation shall be made on the original incoming teletype "1 copy made for relay to SACS _____, (OR LEGATS) _____, (OR GOVERNMENT AGENCIES) _____."
2. Minor editing changes shall be made on the xerox as follows: using a lead pencil ONLY draw single line through the first and last lines of the heading and connect these lines from top right to bottom left forming a "Z," figure. (DO NOT OBLITERATE THE HEADING.) Use horizontal lines to delete sentences or words. Printed changes of a word or two to the text of the message may be made; however, changes to the existing text involving more than a word or two necessitate the originator to initiate a new message using form 0-93.
3. Administrative data or notes may be typed immediately following the text and will be transmitted to all addressees.
4. When using the 0-73 form to disseminate information to field offices, Legal Attaches and other Government agencies simultaneously, the text, notes and administrative data must be identical for all addressees.

26 SEP 79 21 04
RECEIVED
FEDERAL BUREAU
OF INVESTIGATION
COMMUNICATIONS SECTION

N/636

26

b6
b7C

071

O
A
P

[redacted]

MESSAGE RELAY VIA TELETYPE

DATE 9/26/79	CLASSIFICATION SECRET	PRECEDENCE ROUTINE
-----------------	-------------------------------------	-----------------------

FM DIRECTOR FBI

TO

neg

FEDERAL GOVERNMENT

Ord 2

b3
b6
b7C
b7E

[Large redacted area]

(SERVICE ALSO AVAILABLE TO GOVERNMENT AGENCIES NOT LISTED.
CONTACT COMMUNICATIONS CENTER FOR ADDRESSING INFORMATION)

SUBJECT:

185-1241-32

EX-109

REC 20

[redacted]

SEP 27 1979

b3
b7E

APPROVED BY <i>[Signature]</i>	ORIGINATOR [redacted]	ROOM 4147	TELE EXT. 4605
-----------------------------------	--------------------------	--------------	-------------------

b6
b7C

FEDERAL BUREAU OF INVESTIGATION
COMMUNICATIONS SECTION
2142
SEP 26 1979

63 OCT 12 1979

DO NOT FILE WITHOUT COMMUNICATIONS STAMP

USE OF FORM 0-73

1. Only incoming teletype messages which require transmission relay may be prepared for transmission using form 0-73. Use of form 0-73 is restricted to incoming teletype messages received within the last 3 days which require transmission relay; all other teletype messages must be prepared using form 0-93.
2. Additions such as notes and administrative data for a specific addressee are not allowed. If a note or administrative data is required for a particular addressee a separate 0-73 form must be prepared.
3. The message will be transmitted just as it appears. The person approving the message is solely responsible for assuring all necessary editing changes have been made.

PREPARATION OF FORM WHICH CONSISTS OF A PREPRINTED YELLOW.

1. Complete appropriate boxes: date, classification & precedence.
2. List addresses immediately following the "TO" or place a check mark in the appropriate boxes.
3. Type or PRINT the subject in the space provided.
4. Print or type originator's name, room number and telephone extension.
5. Indicate approval for transmission by initialing the "Approved By" box.

26 SEP 19 16 39
RECEIVED
BUREAU
FEDERAL BUREAU
OF INVESTIGATION
COMMUNICATIONS SECTION

PREPARATION OF MESSAGE TO BE TRANSMITTED

1. Xerox 1 copy of incoming teletype message. A notation shall be made on the original incoming teletype "1 copy made for relay to SACS _____, (OR LEGATS) _____, (OR GOVERNMENT AGENCIES) _____."
2. Minor editing changes shall be made on the xerox as follows: using a lead pencil ONLY draw single line through the first and last lines of the heading and connect these lines from top right to bottom left forming a "Z," figure. (DO NOT OBLITERATE THE HEADING.) Use horizontal lines to delete sentences or words. Printed changes of a word or two to the text of the message may be made; however, changes to the existing text involving more than a word or two necessitate the originator to initiate a new message using form 0-93.
3. Administrative data or notes may be typed immediately following the text and will be transmitted to all addressees.
4. When using the 0-73 form to disseminate information to field offices, Legal Attaches and other Government agencies simultaneously, the text, notes and administrative data must be identical for all addressees.

PP HQ NK WF
DE NY 0027

RECEIVED
TELETYPE UNIT

26 SEP 79 0141z

RECEIVED
FEDERAL BUREAU
OF INVESTIGATION
COMMUNICATIONS SECTION

Exec. AD-Adm.	
Exec. AD-Inv.	
Exec. AD-LES	
Asst. Dir.:	
Adm. Servs.	
Crim.	
Ident.	
Intell.	
Labors.	
Legal Coun.	
Plan. & Insp.	
Rec. Mgnt.	
Tech. Servs.	
Training	
Public Affs. Off.	
Telephone Rm.	
Director's Sec'y	

b3
b6
b7C
b7E

P252156Z SEPT 79

FM NEW YORK [redacted]

TO DIRECTOR PRIORITY

NEWARK ROUTINE

WASHINGTON FIELD ROUTINE

BT

~~CONFIDENTIAL~~

PROPOSED VISIT OF FIDEL CASTRO IN CONNECTION WITH THE UNITED NATIONS GENERAL ASSEMBLY, OCTOBER, 1979; [redacted]

DE 26, 1, 2

b3
b6
b7C
b7E

ON SEPTEMBER 25, 1979, A CONFIDENTIAL SOURCE WHO HAS FURNISHED RELIABLE WHO HAS FURNISHED RELIABLE INFORMATION IN THE PAST, ADVISED THAT [redacted]

[redacted]

[redacted] 1021 1025-1241-33

b3
b6
b7C
b7D
b7E

A SECOND CONFIDENTIAL SOURCE WHO HAS ALSO FURNISHED RELIABLE

OCT 16 1979

b6
b7C

265 SE 10 20 LW 16

INTELLIGENCE DIV
REC 20

OCT 23 1979
2-54

PAGE TWO ~~SECRET~~

INFORMATION IN THE PAST, ADVISED THAT [REDACTED]

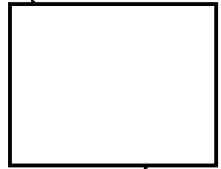

b3
b6
b7C
b7D



~~(C)~~ (U)

~~C AND E 3441, REASON 2 & 3, DRD SEPTEMBER 30, 1999~~

ADMINISTRATIVE

FIRST CONFIDENTIAL SOURCE IS [REDACTED]

b3
b7D

SECOND CONFIDENTIAL SOURCE IS [REDACTED]

TO DATE, INFORMATION FURNISHED BY BOTH SOURCES HAS NOT YET BEEN CORROBORATED.

NYO WILL MAINTAIN CONTACT WITH ASSETS IN AN EFFORT TO DETERMINE THE EXACT DATES OF CASTRO'S VISIT TO THE UNITED STATES.

BT

74
53
26

#

26 SEP 79 03 47z

OO HI LAMM NK NY WF

DE SJ

O 250310Z SEP 79

FM SAN JUAN [redacted] (195-79) (COMMUNICATIONS SECTION)

TO DIRECTOR [redacted] IMMEDIATE

ATTN: INTELLIGENCE DIVISION, CI-2 UNIT, CRIMINAL INVESTIGATION DIVISION

LOS ANGELES ROUTINE
MIAMI [redacted] IMMEDIATE
NEWARK (195-122) IMMEDIATE
NEW YORK IMMEDIATE
WASHINGTON FIELD ROUTINE
R

b3
b6
b7C
b7E

Exec. AD-Adm.	
Exec. AD-Inv.	
Exec. AD-LES	
Asst. Dir.:	
Adm.	
Crim.	
Ident.	
Intell.	
Laboratory	
Legal Coun.	
Plan. & Insp.	
Rec. Mgnt.	
Tech. Serv.	
Training	
Public Affs. Off.	
Telephone Rm.	
Director's Sec'y	

b3
b6
b7C
b7E

~~SECRET~~

[redacted] (OO:SAN JUAN)

PROPOSED VISIT OF CUBAN PREMIER FIDEL CASTRO TO THE UNITED STATES, OCTOBER, 1979: PFO MATTER, (OO:NEW YORK)

REFERENCE NEWARK TELETYPE SEPTEMBER 25, 1979 ENTITLED PROPOSED VISIT OF CUBAN PREMIER FIDEL CASTRO TO THE UNITED STATES, OCTOBER, 1979: PFO MATTER.

THIS TELETYPE IS CLASSIFIED ~~SECRET~~ IN ITS ENTIRETY.

FOR THE INFORMATION OF NEWARK, LOS ANGELES, AND WASHINGTON FIELD, REFERENCED SAN JUAN TELETYPE ADVISED OF [redacted]

b3
b6
b7C
b7E

ORIGINAL FILED IN

b3
b7D
b7E

NOT RECORDED
100 OCT 10 1979

23 OCT 5 1979

TELETYPED TO [redacted]

97 OCT 25 1979

Handwritten initials and numbers: J 70

IF NOT ALREADY DONE SO, MIAMI SHOULD CONTACT [REDACTED] AND

DIRECT HIM TO [REDACTED]

[REDACTED]

DURING SAN JUAN'S LAST CONTACT WITH [REDACTED] ON SEPTEMBER

24, 1979, [REDACTED]

[REDACTED]

FOR THE INFORMATION OF RECIPIENTS, [REDACTED]

[REDACTED] AND AN INDIVIDUAL

IN WHOM [REDACTED]

IT IS POINTED OUT, HOWEVER, THAT

[REDACTED]

SAN JUAN WILL PROVIDE COMMENTS REGARDING THE FEASIBILITY OF

[REDACTED]

b3
b7
b7D

b3
b6
b7C
b7D

b3
b6
b7C
b7D

b3
b6
b7C
b7D

[Redacted]

INTERESTED OFFICES EARLY ON SEPTEMBER 26, 1979.

MIAMI IS REQUESTED TO ADVISE INTERESTED OFFICES OF ANY
INFORMATION DEVELOPED BY [Redacted]

C AND E. 8024, REASONS (2) AND (3), DRD SEPTEMBER 25, 1999.

H

[Redacted]



Exec. AD-Adm.	
Exec. AD-Inv.	
Exec. AD-LES	
Asst. Dir.:	
Adm.	[redacted]
Crim.	[redacted]
Ident.	[redacted]
Insp.	[redacted]
Laboratory	
Legal Coun.	
Plan. & Insp.	
Rec. Mgnt.	
Tech. Serv.	
Training	
Public Affs. Off.	
Telephone Rm.	
Director's Sec'y	

b6
b7C

PP HQ LA NY SJ (VIA HI) WFO RECEIVED TELETYPE UNIT

P 271913Z SEP 79 27 SEP 79 19 30z

FM NEWARK (185-122) (P) (C-3) RECEIVED FEDERAL BUREAU OF INVESTIGATION COMMUNICATIONS SECTION

TO DIRECTOR (P R I O R I T Y)
LOS ANGELES (ROUTINE)
MIAMI (P R I O R I T Y)
NEW YORK (P R I O R I T Y)
SAN JUAN (VIA FBIHQ) (ROUTINE)
WFO (ROUTINE)

BT

~~SECRET~~

PROPOSED VISIT OF CUBAN PREMIER FIDEL CASTRO TO THE UNITED STATES, OCTOBER 5, 1979, PFO MATTER, (OO: NY)

ON SEPTEMBER 25, 1979, [redacted] ADVISED [redacted]

[redacted]
[redacted]
[redacted]
[redacted]

b6
b7C
b7D

185-122-11-34

REC-8

ON SEPTEMBER 26, 1979, SOURCE [redacted]

EX-100 89 02 14 13

ES OCT 5 1979

Recd. by
CERTIFIED
RECEIVED

relay
IT do

b3
b6
b7C
b7E

TELETYPE UNIT

[redacted]

SEP 29 1979

9-28-79

PAGE TWO, NEWARK 185-122, ~~SECRET~~

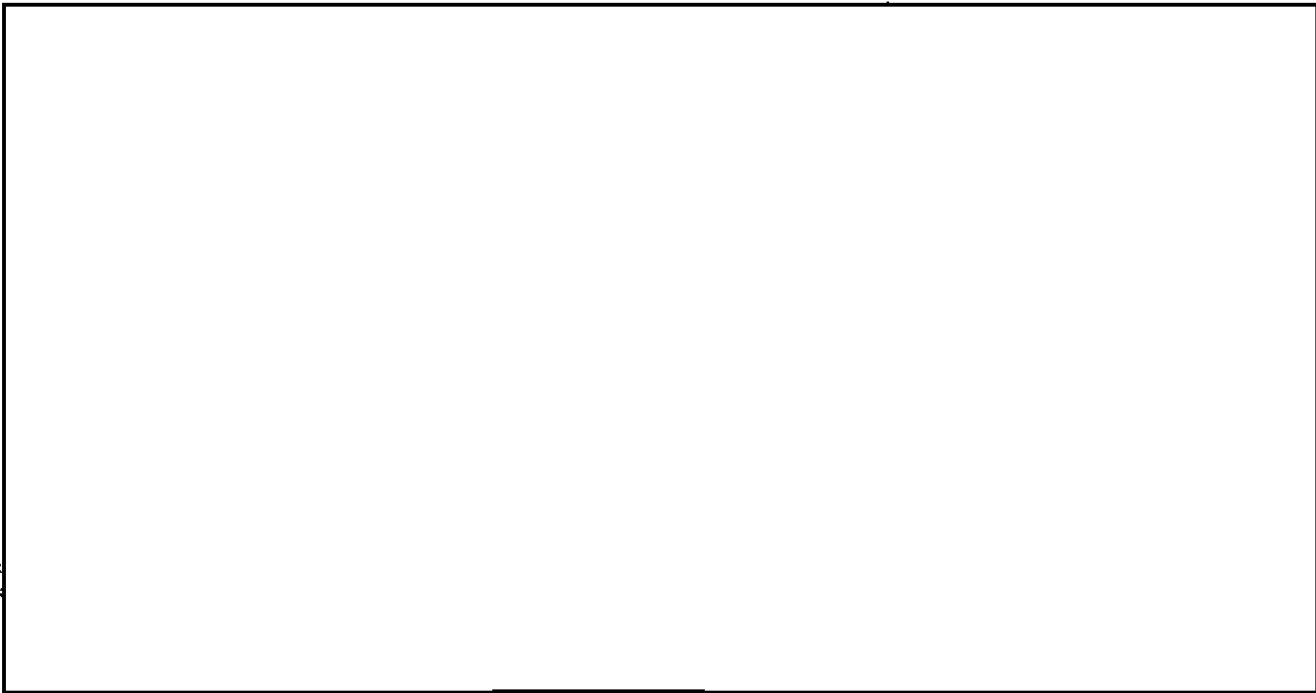

b6
b7C
b7D

ON SEPTEMBER 26, 1979, [REDACTED]

ADVISED [REDACTED]

b7D



NEW YORK POLICE DEPARTMENT

(NYPD) HAS ALLEGEDLY ADVISED THAT [REDACTED]



MIAMI AT MIAMI, FLORIDA, WILL, THROUGH SOURCES, ATTEMPT TO

PAGE THREE, NEWARK 185-122, ~~SECRET~~

[REDACTED] NEWARK WILL

b6
b7C
b7D

DO SAME.

A D M I N I S T R A T I V E

[REDACTED] HAVE PROVIDED RELIABLE INFORMATION

IN THE PAST. THE ABOVE INFORMATION WAS DISSEMINATED TO SECRET
SERVICE, NEWARK, ON SEPTEMBER 27, 1979.

BT

MMO 312 273 3132Z

RECEIVED
TELETYPE UNIT

b3
b6
b7C
b7E

27 SEP 79 11 44z

FEDERAL BUREAU
OF INVESTIGATION
COMMUNICATIONS SECTION

Exec. AD-Adm.
Exec. AD-Inv.
Asst. Dir.:

- Adm. Serv.
- Crim. Inv.
- Ident.
- Intell.
- Laboratory
- Legal Coun.
- Plan. & Insp.
- Rec. Mgmt.
- Tech. Servs.
- Training
- Public Affs. Off.
- Telephone Rm.
- Director's Sec'y

PP HQ NY SJ SF

DE MM

P. 26 3132Z SEP 79

FM MIAMI [redacted] P

TO DIRECTOR PRIORITY

NEW YORK ROUTINE

SAN JUAN (VIA WASHINGTON) ROUTINE

SAN FRANCISCO ROUTINE

BT

~~SECRET~~

ATTENTION: INTD.

[redacted] BUFILE: [redacted]
[redacted]
[redacted]

b3
b6
b7C
b7D
b7E

PROPOSED VISIT OF CUBAN PREMIER FIDEL CASTRO TO THE UNITED STATES, OCTOBER, 1979, PFO MATTER, OO: NEW YORK.

PORTIONS OF THIS TELETYPE ARE CLASSIFIED ~~SECRET~~ AS APPROPRIATELY NOTED BELOW: ON SEPTEMBER 24, 1979, AN OPERATIONAL ASSET WHO HAS FURNISHED RELIABLE INFORMATION SINCE 1979 EAST, ADVISED AS FOLLOWS: [redacted]

195-124-

b3
b6
b7C
b7D
b7E

NOT RECORDED
167 OCT 15 1979

TELETYPE TO:
97 OCT 15 1979 [handwritten initials]

ORIGINAL FILED IN

[REDACTED]

b3
b7E

HOWEVER. ~~(S)~~ (U)

ON SEPTEMBER 24, 1979, [REDACTED] WAS AGAIN INTERVIEWED BY BUREAU AGENTS. [REDACTED]

b6
b7C
b7D

[REDACTED]

[REDACTED] TELEPHONICALLY CONTACTED THE MIAMI OFFICE OF THE FBI ON SEPTEMBER 25, 1979, AND ASKED FOR 24 ADDITIONAL HOURS TO RECONSIDER THIS MATTER. HE REQUESTED TO SEE AGENTS DURING THE MORNING OF SEPTEMBER 26, 1979, FOR REINTERVIEW.

b6
b7C
b7D

~~C AND F BY 6234, REASONS 2 AND 4, DDD SEPTEMBER 26, 1979.~~

ADMINISTRATIVE

RE MIAMI TELETYPE TO THE BUREAU, SEPTEMBER 24, 1979.

OPERATIONAL ASSET IS [REDACTED]

b3
b6
b7C
b7D
b7E

[REDACTED]

[REDACTED] AT WHICH TIME ADDITIONAL IDENTIFYING DATA WILL BE OBTAINED. MIAMI ALSO WILL

PAGE FOUR [REDACTED]

~~SECRET~~

b3
b7E

SPOT CHECK MEETING SITE TO SUPPLEMENT THIS COVERAGE.

[REDACTED] POSSESSION OF EXPLOSIVES DISCUSSED WITH AUSA

[REDACTED] ON SEPTEMBER 24, 1979, AND IT WAS HIS

OPINION THAT [REDACTED]

[REDACTED] MATTER ALSO

b5
b6
b7C

DISCUSSED WITH U.S. PROBATION OFFICER [REDACTED] ON

SEPTEMBER 25, 1979, AND HE INDICATED THAT TESTIMONY OF AGENTS

REGARDING [REDACTED] POSSESSION OF EXPLOSIVES WOULD CONCEIVABLY

BE SUFFICIENT TO SUSTAIN REVOCATION OF PAROLE. [REDACTED] ALSO

ADVISED THAT ON BASIS OF THIS INFORMATION, HE WOULD DENY

TRAVEL REQUEST MADE BY [REDACTED] FOR TRIP TO NEW YORK CITY DURING

COMING WEEK.

b6
b7C

MIAMI INDICES NEGATIVE ON [REDACTED] NUMEROUS REFERENCES

FOUND TO [REDACTED], NONE OF WHICH CAN BE IDENTIFIED AS

THE INDIVIDUAL ASSOCIATED WITH [REDACTED]

b6
b7C

SAN FRANCISCO, AT SANTA CLARA, CALIFORNIA, WILL ATTEMPT

TO IDENTIFY [REDACTED]. INVESTIGATION MUST BE EXTREMELY

DISCREET FOR PROTECTION OF SENSITIVE SOURCE.

BT

#

K

No Tape

b6
b7C

0-73 (Rev. 10-26-75)

A [redacted]
P [redacted]

MESSAGE RELAY VIA TELETYPE

157

DATE <i>9-28-79</i>	CLASSIFICATION <i>Secret</i>	PRECEDENCE <i>Routine</i>
------------------------	---------------------------------	------------------------------

FM DIRECTOR FBI

FEDERAL GOVERNMENT

O-Don 2 2 -

b3
b6
b7C
b7E

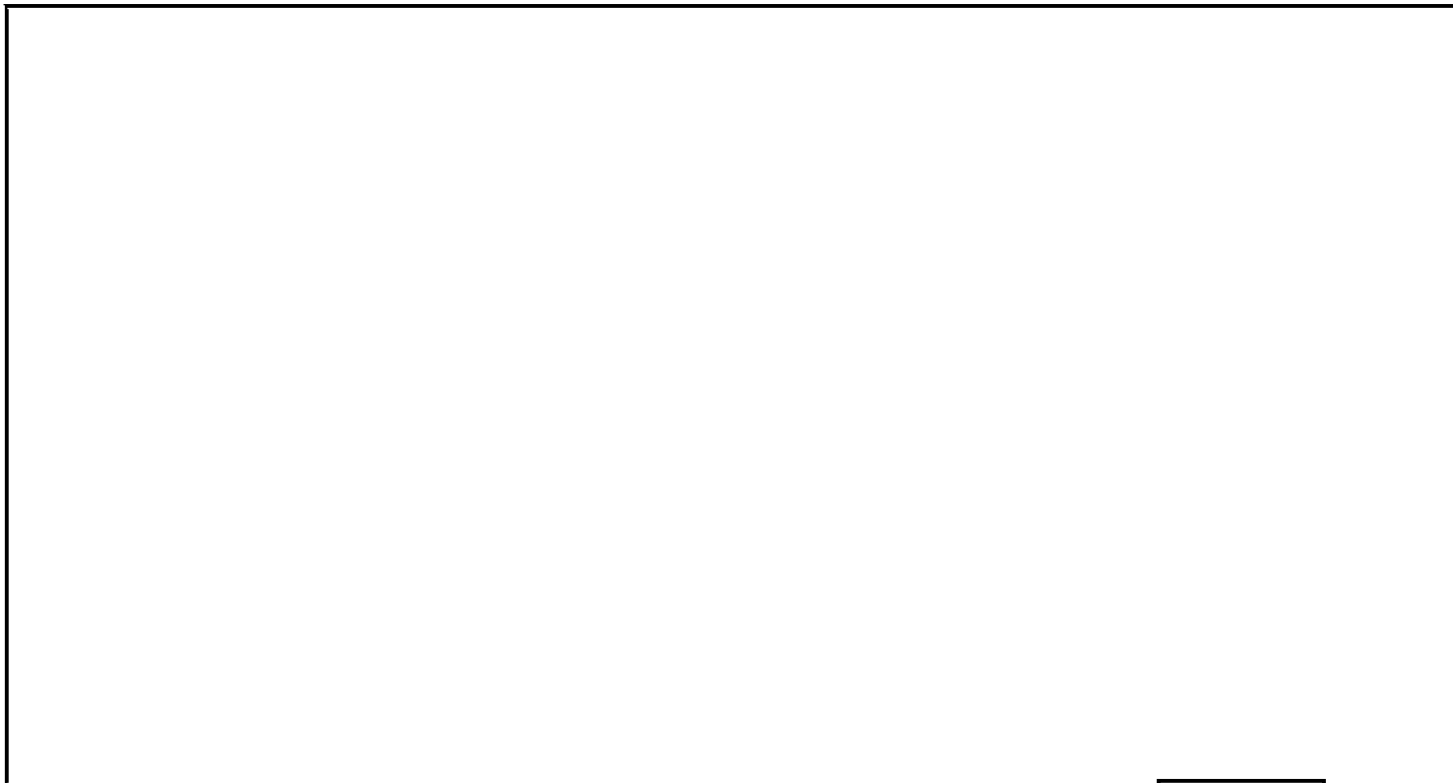

(SERVICE ALSO AVAILABLE TO GOVERNMENT AGENCIES NOT LISTED.)

CONTACT COMMUNICATIONS CENTER FOR ADDRESSING INFORMATION)

SUBJECT:

EX-109

REC 20

185-1241-35

APPROVED BY <i>[Signature]</i>	ORIGINATOR [redacted]	ROOM <i>4051</i>	TELE EXT. <i>4632</i>
-----------------------------------	--------------------------	---------------------	--------------------------

b3
b6
b7C
b7E

60 OCT 25 1979
[Signature]

SEP 29 1979
10522R

DO NOT FILE WITHOUT COMMUNICATIONS STAMP

USE OF FORM 0-73

1. Only incoming teletype messages which require transmission relay may be prepared for transmission using form 0-73. Use of form 0-73 is restricted to incoming teletype messages received within the last 3 days which require transmission relay; all other teletype messages must be prepared using form 0-93.
2. Additions such as notes and administrative data for a specific addressee are not allowed. If a note or administrative data is required for a particular addressee a separate 0-73 form must be prepared.
3. The message will be transmitted just as it appears. The person approving the message is solely responsible for assuring all necessary editing changes have been made.

PREPARATION OF FORM WHICH CONSISTS OF A PREPRINTED YELLOW.

1. Complete appropriate boxes: date, classification & precedence.
2. List addresses immediately following the "TO" or place a check mark in the appropriate boxes.
3. Type or PRINT the subject in the space provided.
4. Print or type originator's name, room number and telephone extension.
5. Indicate approval for transmission by initialing the "Approved By" box.

PREPARATION OF MESSAGE TO BE TRANSMITTED

1. Xerox 1 copy of incoming teletype message. A notation shall be made on the original incoming teletype "1 copy made for relay to SACS _____, (OR LEGATS) _____, (OR GOVERNMENT AGENCIES) _____."
2. Minor editing changes shall be made on the xerox as follows: using a lead pencil ONLY draw single line through the first and last lines of the heading and connect these lines from top right to bottom left forming a "Z," figure. (DO NOT OBLITERATE THE HEADING.) Use horizontal lines to delete sentences or words. Printed changes of a word or two to the text of the message may be made; however, changes to the existing text involving more than a word or two necessitate the originator to initiate a new message using form 0-93.
3. Administrative data or notes may be typed immediately following the text and will be transmitted to all addressees.
4. When using the 0-73 form to disseminate information to field offices, Legal Attaches and other Government agencies simultaneously, the text, notes and administrative data must be identical for all addressees.

RECEIVED
FEDERAL BUREAU
OF INVESTIGATION
COMMUNICATIONS SECTION

28 SEP 79 22 28

Erec. AD-Adm. b6
Erec. AD-Inv. b6
Exec. AD-LES. b6
Asst. Dir. b7C
Adm. Serv. b6
Crim. Inv. b6
Ident. b6
Intell. b6
Laboratory b6
Legal Coun. b6
Plan. & Insp. b6
Rec. Mgnt. b6
Tech. Serv. b6
Training b6
Public Affs. Off. b6
Telephone Rm. b6
Director's Sec'y b6

RECEIVED
TELETYPE UNIT

29 SEP 79 01 47 z

RECEIVED
FEDERAL BUREAU
OF INVESTIGATION
COMMUNICATIONS SECTION

10 070135

PP NY WASH SJ

RECEIVED SEPT 79

[redacted] (P)

TO DIRECTOR PRIORITY

NEW YORK PRIORITY

SAN FRANCISCO PRIORITY

SAN JUAN VIA WASHINGTON PRIORITY

BT

~~SECRET~~

ATTENTION: BUREAU - INTD.

b3
b6
b7C
b7E

[redacted]

b3
b6
b7C
b7E

[redacted]

[redacted]

[redacted] BUREAU FILE [redacted] FILE

[redacted] SAN JUAN FILE [redacted]

[redacted] MIAMI FILE [redacted]

~~PROPOSED VISIT OF CUBAN PREMIER SAGUASTRO TO THE UNITED~~

~~STATE OCTOBER, 1979; PFO MATTER.~~

THIS COMMUNICATION IS CLASSIFIED ~~SECRET~~ IN ITS ENTIRETY.

ON SEPTEMBER 28, 1979, AN OPERATIONAL AGENT HAS

FURNISHED RELIABLE INFORMATION IN THE MATTER AS FOLLOWS:

b3
b6
b7C
b7D
b7E

[redacted]

[redacted]

266 SA

185-1241

NOT RECORDED
10
OCT 17 1979

WLS - FIC - [redacted]

TELETYPE TO:

SJ

[redacted]

64 DEC 5 1979

ORIGINAL FILED IN

[Redacted]

~~SECRET~~

[Redacted]

b3
b6
b7C
b7D
b7E

~~C AND E BY 6054, REASONS (2) AND (3), DB [Redacted] MB~~

~~1999~~

ADMINISTRATIVE:

RE MIAMI TELETYPE TO THE BUREAU SEPTEMBER 27, 1979.

OPERATIONAL ASSET IS

[Redacted]

[Redacted]

b3
b7D
b7E

[REDACTED]

~~SECRET~~

b3
b7D
b7E

[REDACTED]

MIAMI WILL COVER ARRIVAL OF [REDACTED] AT MIAMI
INTERNATIONAL AIRPORT AND ATTEMPT TO OBTAIN PHOTOGRAPH.

b6
b7C

NEW YORK ATTEMPT TO OBTAIN ADDRESS FOR [REDACTED]

[REDACTED]

~~CLASSIFIED BY 6034, REASONS (2) AND (3), DTD SEPTEMBER 28,~~

~~1999~~

37

FEDERAL BUREAU OF INVESTIGATION
FOI/PA
DELETED PAGE INFORMATION SHEET
FOI/PA# 1362425-000

Total Deleted Page(s) = 58

- Page 2 ~ Referral/Direct;
- Page 3 ~ Referral/Direct;
- Page 4 ~ Referral/Direct;
- Page 5 ~ Referral/Direct;
- Page 6 ~ Referral/Direct;
- Page 12 ~ Duplicate;
- Page 13 ~ Duplicate;
- Page 14 ~ Duplicate;
- Page 15 ~ Duplicate;
- Page 18 ~ b6; b7C;
- Page 19 ~ b6; b7C;
- Page 20 ~ b6; b7C;
- Page 21 ~ b6; b7C;
- Page 22 ~ b6; b7C;
- Page 34 ~ b3; b6; b7C; b7D; b7E;
- Page 37 ~ Duplicate;
- Page 38 ~ Duplicate;
- Page 39 ~ Duplicate;
- Page 62 ~ b3; b6; b7C; b7E;
- Page 63 ~ b3; b6; b7C; b7E;
- Page 64 ~ b3; b6; b7C; b7E;
- Page 65 ~ b3; b6; b7C; b7E;
- Page 66 ~ b3; b6; b7C; b7E;
- Page 67 ~ b3; b6; b7C; b7E;
- Page 68 ~ b3; b6; b7C; b7E;
- Page 69 ~ b3; b6; b7C; b7E;
- Page 70 ~ b3; b6; b7C; b7E;
- Page 71 ~ b3; b6; b7C; b7E;
- Page 77 ~ Referral/Direct;
- Page 78 ~ Referral/Direct;
- Page 79 ~ Duplicate;
- Page 80 ~ Duplicate;
- Page 83 ~ b6; b7C; b7E;
- Page 84 ~ b6; b7C; b7E;
- Page 85 ~ b6; b7C; b7E;
- Page 86 ~ b6; b7C; b7E;
- Page 87 ~ b6; b7C; b7E;
- Page 88 ~ b6; b7C; b7E;
- Page 89 ~ b6; b7C; b7E;
- Page 90 ~ b6; b7C; b7E;
- Page 91 ~ b6; b7C; b7E;
- Page 92 ~ b6; b7C; b7E;
- Page 99 ~ Duplicate;
- Page 100 ~ Duplicate;
- Page 101 ~ Duplicate;
- Page 103 ~ b6; b7C; b7E;
- Page 104 ~ b6; b7C; b7E;
- Page 105 ~ b6; b7C; b7E;
- Page 106 ~ b6; b7C; b7E;
- Page 107 ~ b6; b7C; b7E;
- Page 118 ~ b3; b6; b7C; b7D; b7E;
- Page 119 ~ b3; b6; b7C; b7D; b7E;
- Page 124 ~ b6; b7C; b7E;
- Page 125 ~ b6; b7C; b7E;
- Page 126 ~ b6; b7C; b7E;
- Page 129 ~ b6; b7C; b7D;
- Page 130 ~ b6; b7C; b7D;
- Page 134 ~ b3; b6; b7C; b7D; b7E;

XXXXXXXXXXXXXXXXXXXXXXXXXXXX
X Deleted Page(s) X
X No Duplication Fee X
X For this Page X
XXXXXXXXXXXXXXXXXXXXXXXXXXXX

DEPARTMENT OF JUSTICE
FEDERAL BUREAU OF INVESTIGATION
COMMUNICATION MESSAGE FORM

b6
b7c

PAGE 1 OF 2
DATE 10-2-79

CLASSIFICATION UNCLAS E F T O

PRECEDENCE ROUTINE

#ELL4ERR LA MM NK NY SJ S*WFEDE HQ HOLLA #HTYERR 022149Z OCT 79

START HERE

FM

DIRECTOR FBI

TO

FBI LOS ANGELES ROUTINE

FBI NEWARK ROUTINE

14

FBI NEW YORK ROUTINE

FBI MIAMI ROUTINE

12

FBI SAN JUAN ROUTINE

FBI WASHINGTON FIELD ROUTINE

10

BT

UNCLAS E F T O

8

PROPOSED VISIT OF CUBAN PREMIER FIDEL CASTRO TO THE UNITED STATES, OCTOBER 19, 1979, PFO: 00: NEW YORK.

6

REFERENCE FBIHQ TELETYPE TO LOS ANGELES DATED SEPTEMBER 25, 1979, AND USSS TELETYPE TO FBIHQ DATED OCTOBER 1, 1979.

4

ON OCTOBER 1, 1979, USSS HEADQUARTERS ADVISED IN REFERENCED TELETYPE THAT LIAISON BETWEEN FBI AGENTS IN THE MIAMI AND NEWARK DIVISIONS AND USSS AGENTS HAVE IDENTIFIED PERSONS BOTH

DO NOT TYPE MESSAGE BELOW THIS LINE

APPROVED BY

SM

DRAFTED BY

DATE

10-2-79

4051

FILE EXT.

4632

SEE NOTE ON PAGE THREE

- 1 -
- 1 -
- 1 -
- 1 -
- 1 -
- 1 -

[Redacted]

OCT 3 1979

b3
b6
b7c
b7E

FEDERAL BUREAU OF INVESTIGATION
COMMUNICATIONS SECTION

OCT 03 1979

DO NOT FILE WITHOUT COMMUNICATIONS STAMP

DEPARTMENT OF JUSTICE
FEDERAL BUREAU OF INVESTIGATION
COMMUNICATION MESSAGE FORM

PAGE 2

CONTINUATION SHEET

PAGE TWO DE HQ 0114 UNCLAS E F T O

AGENCIES BELIEVE PRESENT A DANGER TO CASTRO DURING HIS VISIT TO THE UNITED STATES AND SHOULD BE INTERVIEWED JOINTLY.

DUE TO TIME CONSTRAINTS, USSS HEADQUARTERS HAS ADVISED THEIR FIELD OFFICES THEY NO LONGER MUST HOLD AN ABEYANCE INTERVIEWS SUBJECT TO OFFICIAL NOTICE FROM THE DEPARTMENT OF STATE OF CASTRO'S OFFICIAL VISIT. USSS AGENTS IN MIAMI AND NEWARK HAVE BEEN INSTRUCTED TO PARTICIPATE IN JOINT FBI-USSS INTERVIEWS UPON AUTHORIZATION OF THE SPECIAL AGENT IN CHARGE OF THE CONCERNED FBI FIELD OFFICE.

MIAMI AND NEWARK DIVISIONS ARE INSTRUCTED TO HANDLE THESE JOINT FBI-USSS INTERVIEWS IN ACCORDANCE WITH INSTRUCTIONS IN REFERENCED FBIHQ TELETYPE.

BT

*

DO NOT TYPE PAST THIS LINE

DO NOT TYPE MESSAGE BELOW THIS LINE

NOTE: USSS HEADQUARTERS, BY TELETYPE, REQUESTED FBI AGENT ASSISTANCE IN JOINT INTERVIEWS OF PERSONS THEY BELIEVE CONSTITUTE A DANGER TO FIDEL CASTRO SHOULD HE VISIT THE UNITED NATIONS IN NEW YORK IN OCTOBER. FBIHQ RESPONDED TO USSS HEADQUARTERS BY TELETYPE DATED 9-20-79, SETTING FORTH CRITERIA UNDER WHICH AUTHORIZATION OF SUCH JOINT INVESTIGATION WILL BE CONDUCTED. USSS, BY TELETYPE DATED 9-24-79, CONCURRED WITH THE CONDITIONS SET FORTH IN REFERENCED BUREAU TELETYPE TO USSS AND ADVISED NO OFFICIAL NOTIFICATION HAS BEEN RECEIVED FROM STATE DEPARTMENT REGARDING CASTRO'S CONTEMPLATED VISIT TO THE UNITED STATES.

USSS HEADQUARTERS, BY TELETYPE TO FBIHQ DATED 10-1-79, ADVISED THEY HAVE INSTRUCTED THEIR AGENTS THAT THEY NO LONGER MUST HOLD THEIR INTERVIEWS IN ABEYANCE UNTIL OFFICIAL NOTIFICATION OF CASTRO'S VISIT IS RECEIVED FROM DEPARTMENT OF STATE. A LIST OF PERSONS DESIRED TO BE INTERVIEWED JOINTLY BY FBI AND USSS HAS BEEN SUPPLIED BY USSS HEADQUARTERS AND REVIEWED WITHOUT LOCATING A PERSON WHO SHOULD NOT BE INTERVIEWED.

b6
b7C

NY0886 2750126

PP HQ MM HI

DE NY 0035

P012322Z OCT 79

FM NEW YORK (87-81067)(M-10)

TO DIRECTOR PRIORITY

MIAMI PRIORITY

SAN JUAN PRIORITY (VA FBIHQ)

BT

~~SECRET~~

RECEIVED
TELETYPE UNIT

7 OCT 79 01 39z

FEDERAL BUREAU
OF INVESTIGATION
COMMUNICATIONS SECTION

Exec AD-Adm.	
Exec AD-Inv.	
Exec AD-LES.	
Asst Dir.:	
Adm. Serv.	
Crim. Inv.	
Ident.	
Laboratory	
Legal Coun.	
Plan. & Insp.	
Rec. Mgnt.	
Tech. Servs.	
Training	
Public Affs. Off.	
Telephone Rm.	
Director's Sec'y	

b6
b7C

PROPOSED VISIT OF CUBAN PREMIER FIDEL CASTRO TO THE UNITED STATES, OCTOBER 1979; PFO MATTER.

REMMTEL, SEPTEMBER 28, 1979.

TELEPHONE NUMBER [redacted] IS SUBSCRIBED TO BY [redacted]

b6
b7C

[redacted]
UNITED STATES SECRET SERVICE, NEW YORK CITY, CONTACTED ON OCTOBER 1, 1979, AND AS OF THIS DATE, CASTRO'S DATE OF ARRIVAL IS STILL UNKNOWN. IN FACT, UNITED STATES SECRET SERVICE IS NOT AWARE IF CASTRO IS ACTUALLY TRAVELLING TO THE UNITED STATES OR IF HE WILL SEND A REPRESENTATIVE. SPECULATION IS THAT THE CASTRO GOVERNMENT IS AWAITING THE RESULTS OF PRESIDENT CARTER'S SPEECH CONCERNING THE PRESENCE OF

105-1241-39

b3
b6
b7C
b7E

EX 100

REC-65

OCT 16 1979

TELETYPE

53 6

1979

b6
b7C

PAGE TWO ~~SECRET~~

SOVIET TROOPS IN CUBA. THE SPEECH IS SCHEDULED FOR 9:00 PM,
ON OCTOBER 1, 1979.

~~C AND E 5815, REASON 2, DRD OCTOBER 1, 1999.~~

BT

MMO015 2760005Z

RECEIVED
TELETYPE UNIT

b6
b7C

PP HI LA NK NY SJ WF

30 OCT 79 00 13z

DE MM

RECEIVED
FEDERAL BUREAU
OF INVESTIGATION
COMMUNICATIONS SECTION

P 020005Z OCT 79

FM MIAMI (185-126) P

TO DIRECTOR PRIORITY

LOS ANGELES PRIORITY

NEWARK PRIORITY

NEW YORK PRIORITY

SAN JUAN (VIA WASHINGTON) PRIORITY

WASHINGTON FIELD OFFICE PRIORITY

BT

DECLASSIFIED BY [redacted]
ON 8-14-98 (JFK)

~~CONFIDENTIAL~~

PROPOSED VISIT OF CUBAN PREMIER FIDEL CASTRO TO THE UNITED STATES

OCTOBER, 1979; PFO MATTER (OO: NEW YORK)

EX-109

185-1241-41

RE BUREAU TELETYPE TO LOS ANGELES, SEPTEMBER 26, 1979.

ON SEPTEMBER 27, 1979, SPECIAL AGENTS, MIAMI DIVISION,

454

CONFERRED WITH SA [redacted] U.S. SECRET SERVICE, MIAMI,

FLORIDA, CONCERNING PERSONS WITHIN THE MIAMI DIVISION WHO COULD

OCT 5 1979

POSSIBLY PRESENT A DANGER TO PREMIER FIDEL CASTRO OF CUBA

Exec. AD-Adm.	
Exec. AD-Inv.	
Exec. AD-LES	
Asst.	
Adm.	
Crim.	
Ident.	
Intell.	
Laboratory	
Legal Coun.	
Plan. & Insp.	
Rec. Mgnt.	
Tech. Servs.	
Training	
Public Affs. Off.	
Telephone Rm.	
Director's Sec'y	

b6
b7C

b3
b6
b7C
b7E

b6
b7C

TELETYPE

5
29 1979

PAGE TWO MM (185-126) ~~CONFIDENTIAL~~

DURING HIS VISIT TO THE U.S.

THE FOLLOWING LIST OF SUCH INDIVIDUALS IS SET FORTH HEREAFTER:



b6
b7C

RR HI N MM LA

DE NK 010

R 032230Z OCT 79

FM NEWARK (185-122) (P) (HRA)

TO DIRECTOR (ROUTINE)

NEW YORK (185-899) (ROUTINE)

MIAMI (185-126) (ROUTINE)

LOS ANGELES (ROUTINE)

BT

~~SECRET~~

PROPOSED VISIT OF CUBAN PREMIER FIDEL CASTRO TO THE UNITED STATES
OCTOBER, 19-9; PFO (OO: NY)

ON OCTOBER 2, 1979, A CONFIDENTIAL SOURCE WHOSE RELIABILITY
HAS NOT YET BEEN ESTABLISHED DUE TO INSUFFICIENT CONTACT, ADVISED
AS FOLLOWS:

RECEIVED
TELETYPE UNIT
30 OCT 79 22 40z

RECEIVED
FEDERAL BUREAU
OF INVESTIGATION
COMMUNICATIONS SECTION

Exec. AD-Adm.	
Exec. AD-Inv.	
Exec. AD-LES	
Asst. Dir.:	
Adm.	
Crim.	
Ident.	
Intell.	
Laboratory	
Legal Coun.	
Plan. & Insp.	
Rec. Mgnt.	
Tech. Servs.	
Training	
Public Affs. Off.	
Telephone Rm.	
Director's Sec'y	

b6
b7C

b6
b7C

b6
b7C

b3
b6
b7C
b7D
b7E

SI-126

OCT 9 1979

10/10/79
WH-NSC
USSS
Customs
FARA
DOS

b3
b6
b7C
b7E

64 00 079

[REDACTED]

b7D

THE SOURCE ADVISED THAT [REDACTED]

[REDACTED]

b7D

ON OCTOBER 3, 1979, [REDACTED] A SOURCE WHO HAS PROVIDED
RELIABLE INFORMATION IN THE PAST, ADVISED THAT [REDACTED]

[REDACTED]

b3
b6
b7C
b7D



b3
b6
b7C
b7D

A D M I N I S T R A T I V E

THE CONFIDENTIAL SOURCE IS

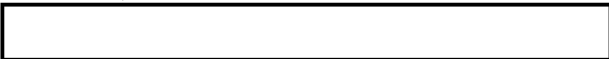

b7D

 DESPITE THE FACT THERE HAS BEEN INSUFFICIENT CONTACT WITH THIS SOURCE, HE IS IN A POSITION TO FURNISH RELIABLE INFORMATION IN THIS MATTER.

(C AND E 953, FCIM REASONS 2 AND 3, DRD OCTOBER 3, 1999.)

BT

#

RECEIVED
TELETYPE UNIT

SFO. 666 2772100

VP HQ MM NY SJ

DE SF 003

P 0042056Z OCT 79

FM SAN FRANCISCO [redacted] (P) (SQ. 14)

TO DIRECTOR, FBI [redacted] PRIORITY

MIAMI [redacted] PRIORITY

NEW YORK PRIORITY

SAN JUAN [redacted] (185-70) PRIORITY SJ VIA FBIHQ

BT

UNCLAS

PROPOSED VISIT OF CUBAN PREMIER FIDEL CASTRO TO THE UNITED STATES,
OCTOBER, 1979; PFO MATTERS; OO: NEW YORK

RE MIAMI TELETYPE TO THE DIRECTOR; ET AL, SEPTEMBER 26, 1979.
INVESTIGATION CONDUCTED BY SECRET SERVICE, FBI, AND THE
SAN JOSE POLICE DEPARTMENT.

ON OCTOBER 3, 1979, [redacted]

[redacted] TELEPHONE 185-1241-43

NUMBER [redacted] DATE OF BIRTH - [redacted]

[redacted] [redacted]

REC-124

11 OCT 11 1979

63 [redacted] 179
TELETYPED
52

[redacted] [redacted]

[redacted] XEROX
OCT 12 1979

Exec. AD-Adm.	
Exec. AD-Inv.	
Exec. AD-LES.	
Asst. Dir.:	
Adm.	[redacted]
Crim.	[redacted]
Ident.	
Intell.	
Laboratory	
Legal Coun.	
Plan. & Insp.	
Rec. Mgmt.	
Tech. Servs.	
Training	
Public Affs. Off.	
Telephone Rm.	
Director's Sec'y	

b6
b7C
b3
b6
b7C
b7E

UNRECORDED COPY FILED IN

b6
b7C

PAGE TWO

UNCLAS

b3
b6
b7C
b7E

[REDACTED]
[REDACTED] PLACE OF BIRTH - [REDACTED] PROVIDED THE FOLLOWING
INFORMATION:

SINCE MAY, 1979, SHE HAS RESIDED AT THE ABOVE RESIDENCE
WITH [REDACTED] ADDITIONALLY, ON SEPTEMBER 28,
1979, SHE DROVE [REDACTED] TO SAN FRANCISCO INTERNATIONAL AIRPORT, (SFIA),
AND DROPPED HIM OFF AT APPROXIMATELY 7:00 A.M. FOR HIM TO CATCH
A NATIONAL AIRLINES FLIGHT TO MIAMI, FLORIDA, FROM SAN FRANCISCO,
CALIFORNIA, WHICH DEPARTED APPROXIMATELY 8:00 A.M. [REDACTED]
DUE TO RETURN TO SAN JOSE, CALIFORNIA, ON OCTOBER 6, 1979.

b6
b7C

TRANSPORTATION UNKNOWN.

FURTHER, [REDACTED] HAS A CURRENT PASSPORT ISSUED EITHER MAY, 1979,
OR JUNE, 1979, AT UNKNOWN LOCATION IN HIS POSSESSION. EXTRA
PASSPORT PHOTO IN POSSESSION OF SECRET SERVICE IN SAN FRANCISCO
TO BE SENT TO INTERESTED SECRET SERVICE OFFICES.

b6
b7C

[REDACTED] STATED THAT TO HER KNOWLEDGE [REDACTED] HAD NO WEAPONS -
DESTRUCTIVE DEVICES IN HIS POSSESSION.

b6
b7C

[REDACTED] WAS WEARING THE FOLLOWING CLOTHING UPON THE DROP AT
SFIA: WHITE SHIRT CALLED A "GUAYABERA"; GRAY AND WHITE STRIPED
PANTS; BLACK SHOES.

PAGE THREE

[REDACTED] UNCLAS

[REDACTED] STATED THAT [REDACTED] CALLED HER ON SEPTEMBER 28, 1979, AND AGAIN ON SEPTEMBER 29, 1979, FROM MIAMI, FLORIDA. SHE HAS NOT HEARD FROM HIM SINCE. DURING THE COURSE OF THE INTERVIEW OF [REDACTED], SHE EXECUTED A CONSENT TO SEARCH HER RESIDENCE, [REDACTED]

[REDACTED] AND THE

FOLLOWING ITEMS WERE OBSERVED: COLT AR-15 .223 CALIBER RIFLE, SERIAL NO. [REDACTED] AN UNKNOWN MAKE MAUSER MILITARY RIFLE CONVERTED TO A "SPORTER" 7MM (7 X 57), SERIAL NO. [REDACTED] A COMMANDO MARK III, .45 CALIBER CARBINE, SERIAL NO. [REDACTED] (THIS WEAPON LOOKS LIKE A THOMPSON SUBMACHINE GUN); A PLAINFIELD, .30 CALIBER, MI CARBINE, SERIAL NO. [REDACTED] A HIGH STANDARD "DOUBLE NINE" NINE SHOT, .22 CALIBER REVOLVER (NICKEL PLATED WESTERN STYLE), SERIAL [REDACTED] MILITARY WEBBING GEAR AND HOLSTERS; TWO INERT MILITARY CLAYMORE MINES WITH GENERATORS; MISCELLANEOUS EMPTY RIFLE CARTRIDGES; MISCELLANEOUS CLASS "C" COMMON FIREWORKS (NOT ILLEGAL UNDER CALIFORNIA STATUTES); MAGAZINES AND CLIPS AS FOLLOWS: FOUR AR-15 12; THREE .45 GOVERNMENT MODEL PISTOLS, TWO .45 COMMANDO MARK III; TWO MI CARBINE; FOUR BOXES (250 ROUNDS EACH) BELTED 7.62MM BLANK AMMUNITION; ONE POUND CAN HERCULES RED DOT; ONE MR 3031 SMOKELESS SHOTGUN POWDER; ONE POUND DUPONT

b3
b6
b7C
b7E

b6
b7C

b6
b7C

PAGE FOUR

[REDACTED]

UNCLAS

b3
b7E

SMOKELESS RIFLE POWDER; MISCELLANEOUS RIFLE AMMUNITION OF THE FOLLOWING CALIBERS: .22 CALIBER; 7MM MAUSER; .45 CALIBER BALL; AND 5.56MM BLANKS; MISCELLANEOUS (APPROXIMATELY 15) MILITARY TRAINING MANUALS; ONE MILITARY NON-SERRATED PRACTICE GRENADE, BLUE IN COLOR, NO EXPLOSIVE CHARGE.

THE FOLLOWING ITEMS WERE SEIZED BY THE SAN JOSE POLICE DEPARTMENT BOMB SQUAD AS CONTRABAND: TWO PACKS COMMON FIRECRACKERS; ONE AN-M37 AZ DOUBLE STAR ILLUMINATION ROUND (37MM) (THIS DEVICE IS USED FOR EMERGENCY SIGNALING PURPOSES AND IS EXEMPT FROM CALIFORNIA LAW AS A DESTRUCTIVE DEVICE); ONE EACH M117 BOOBY TRAP TRAINING SIMULATOR, MILITARY.

ALL ITEMS OBSERVED WERE CHECKED FOR LEGALITY AND WERE DEEMED THE PROPERTY OF THE OCCUPANT. ADDITIONALLY, THE ITEMS SEIZED BY THE SAN JOSE POLICE DEPARTMENT WERE OF NO PROSECUTIVE VALUE.

ALL LOGICAL CHECKS FOR ARREST WARRANTS ON [REDACTED] WERE NEGATIVE.

b6
b7C

DURING THE SEARCH, AN ADDRESS BOOK BELONGING TO [REDACTED] WAS LOCATED, WHICH CONTAINED THE FOLLOWING INFORMATION: (1) [REDACTED]

[REDACTED]

b6
b7C

[REDACTED]

b3
b6
b7C
b7E

[REDACTED]
[REDACTED] STATED THAT [REDACTED] HAS A DAUGHTER NAMED [REDACTED] ALSO KNOWN AS [REDACTED] TELEPHONE NUMBER [REDACTED] WHOSE HOME HE RESIDED DURING EARLY SEPTEMBER, 1979.

ALSO LOCATED IN THE SEARCH WERE HOSPITAL PATIENTS WRIST STRAPS, WHICH CONTAINED THE FOLLOWING INFORMATION: NAME [REDACTED] DATE SEPTEMBER 3, 1979; PALMETTO GENERAL HOSPITAL, HILELAH, FLORIDA; [REDACTED] (MAY BE [REDACTED] SOCIAL SECURITY NUMBER).

b6
b7C

[REDACTED] STATED THAT HER PARENTS, [REDACTED] RESIDE AT [REDACTED], TELEPHONE [REDACTED]

b3
b6
b7C
b7E

[REDACTED] IT SHOULD BE NOTED THAT [REDACTED]
[REDACTED]

[REDACTED] ALSO, [REDACTED] STATED HER PARENTS USE TO LIVE ON [REDACTED] WHICH IS WHERE [REDACTED] USE TO LIVE. IT IS BELIEVED BY SAN FRANCISCO THAT THEY ARE THE SAME. ADDITIONALLY, SHE HAS A COUSIN CALLED [REDACTED]

b6
b7C

[REDACTED]

[REDACTED] WAS INSTRUCTED BY THE FBI THAT IF [REDACTED] SHOULD

PAGE SIX

[REDACTED] UNCLAS

CONTACT HER TO HAVE HIM IMMEDIATELY CONTACT THE NEAREST FBI OFFICE
OR SA [REDACTED], WHO HAS DEALT WITH HIM IN THE PAST.

LEADS BEING LEFT TO THE DISCRETION OF RECEIVING OFFICES. ?

INVESTIGATION AT SAN FRANCISCO CONTINUING.

BT

b3
b6
b7C
b7E

b6
b7C

Exec. AD-Adm.	
Exec. AD-Inv.	
Exec. AD-LES	
Asst. Dir.:	
Adm. Serv.	
Crim. Inv.	
Ident.	
Intell.	[redacted]
Laboratory	
Legal Coun.	
Plan. & Insp.	
Rec. Mgnt.	
Tech. Serv.	
Training	
Public Affs. Off.	
Telephone Rm.	
Director's Sec'y	

RECEIVED
TELETYPE UNIT

SJ0194 2760215Z

RR HI MM NK NY SF WF

30 OCT 79 04 23z

DE SJ

FEDERAL BUREAU OF INVESTIGATION
COMMUNICATIONS SECTION

R 020215Z OCT 79

FM SAN JUAN [redacted] (185-70) [redacted]

b3
b6
b7C
b7E

TO DIRECTOR [redacted] ROUTINE

ATTENTION: INTELLIGENCE DIVISION, CI-2 UNIT, CRIMINAL
INVESTIGATIVE DIVISION

MIAMI [redacted] ROUTINE

b3
b7E

NEWARK ROUTINE

NEW YORK ROUTINE

SAN FRANCISCO ROUTINE

WASHINGTON FIELD ROUTINE

BT

~~SECRET~~

ORIGINAL FILED IN [redacted]

[redacted] (OO: SAN JUAN)

b3
b7E

PROPOSED VISIT OF CUBAN PREMIER FIDEL CASTRO TO THE UNITED

STATES, OCTOBER, 1979; PFO MATTER, (OO: NEW YORK)

[redacted] (OO: MIAMI)

7 OCT 8 1979

63N

979
ED TU
41560

[redacted]

NOT RECORDED
100 OCT 10 1979

b3
b6
b7C
b7E

PAGE TWO

~~SECRET~~

b3
b7E

REFERENCE SAN JUAN TELETYPE, OCTOBER 1, 1979, ENTITLED,

[REDACTED], PROPOSED VISIT OF CUBAN PREMIER

FIDEL CASTRO TO THE UNITED STATES, OCTOBER, 1979; PFO MATTER.

THIS TELETYPE IS CLASSIFIED "~~SECRET~~" IN ITS ENTIRETY.

ON OCTOBER 1, 1979, [REDACTED] ADVISED [REDACTED]

b3
b6
b7C
b7D

THE ASSET FURTHER ADVISED [REDACTED]

b3
b6
b7C
b7D

067 [redacted]

U [redacted]
A [redacted]
P [redacted]

MESSAGE RELAY VIA TELETYPE

DATE 10/4/79	CLASSIFICATION SECRET	PRECEDENCE PRIORITY
-----------------	-------------------------------------	------------------------

FM DIRECTOR FBI

TO

~~FEDERAL GOVERNMENT~~

old page

b3
b6
b7C
b7E

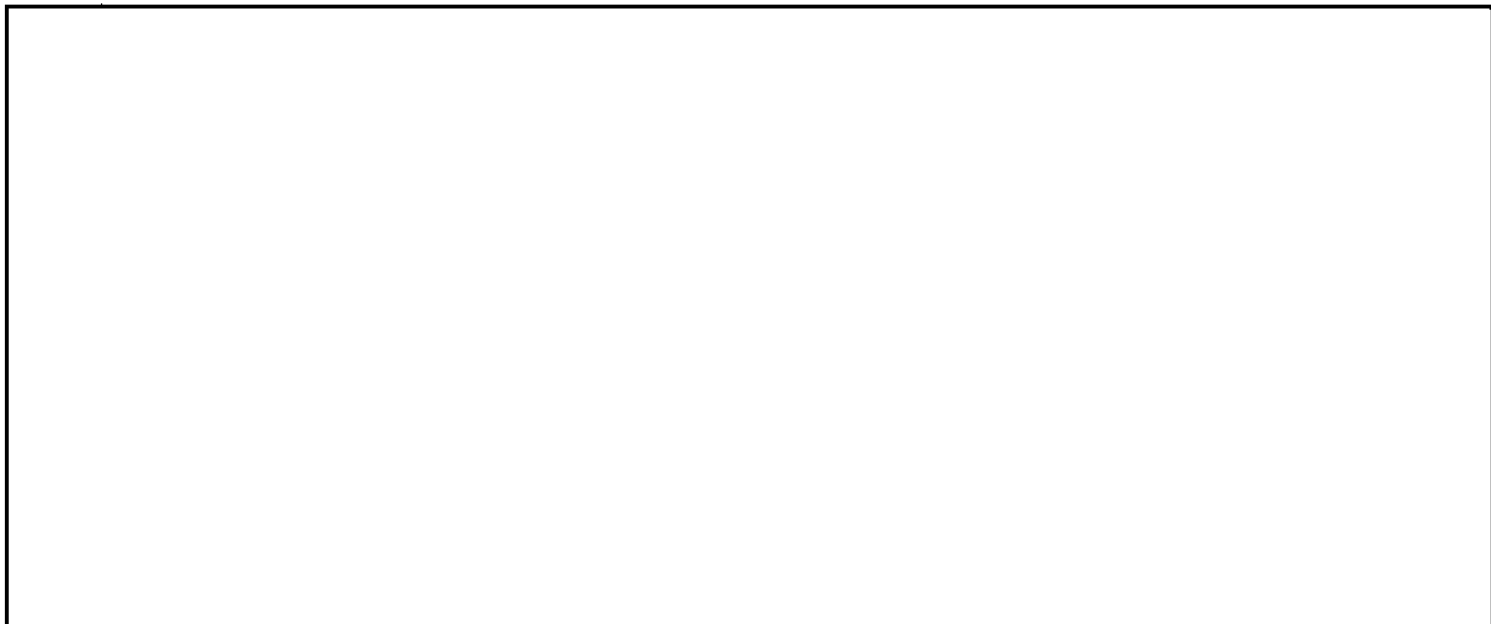

[redacted]

185-1241-44

b3
b7E

(SERVICE ALSO AVAILABLE TO GOVERNMENT AGENCIES NOT LISTED.
CONTACT COMMUNICATIONS CENTER FOR ADDRESSING INFORMATION)

SUBJECT:

REC-106

OCT 9 1979

APPROVED BY [signature]	ORIGINATOR [redacted]	ROOM 44048	TELE EXT.
----------------------------	--------------------------	---------------	-----------

b6
b7C

6300 [redacted]

FEDERAL BUREAU OF INVESTIGATION
COMMUNICATIONS SECTION
03082 [redacted]
OCT 05 1979

DO NOT FILE WITHOUT COMMUNICATIONS STAMP

USE OF FORM 0-73

1. Only incoming teletype messages which require transmission relay may be prepared for transmission using form 0-73. Use of form 0-73 is restricted to incoming teletype messages received within the last 3 days which require transmission relay; all other teletype messages must be prepared using form 0-93.
2. Additions such as notes and administrative data for a specific addressee are not allowed. If a note or administrative data is required for a particular addressee a separate 0-73 form must be prepared.
3. The message will be transmitted just as it appears. The person approving the message is solely responsible for assuring all necessary editing changes have been made.

PREPARATION OF FORM WHICH CONSISTS OF A PREPRINTED YELLOW.

1. Complete appropriate boxes: date, classification & precedence.
2. List addresses immediately following the "TO" or place a check mark in the appropriate boxes.
3. Type or PRINT the subject in the space provided.
4. Print or type originator's name, room number and telephone extension.
5. Indicate approval for transmission by initialing the "Approved By" box.

PREPARATION OF MESSAGE TO BE TRANSMITTED

1. Xerox 1 copy of incoming teletype message. A notation shall be made on the original incoming teletype "1 copy made for relay to SACS _____, (OR LEGATS) _____, (OR GOVERNMENT AGENCIES) _____."
2. Minor editing changes shall be made on the xerox as follows: using a lead pencil ONLY draw single line through the first and last lines of the heading and connect these lines from top right to bottom left forming a "Z," figure. (DO NOT OBLITERATE THE HEADING.) Use horizontal lines to delete sentences or words. Printed changes of a word or two to the text of the message may be made; however, changes to the existing text involving more than a word or two necessitate the originator to initiate a new message using form 0-93.
3. Administrative data or notes may be typed immediately following the text and will be transmitted to all addressees.
4. When using the 0-73 form to disseminate information to field offices, Legal Attaches and other Government agencies simultaneously, the text, notes and administrative data must be identical for all addressees.

RECEIVED
FEDERAL BUREAU
OF INVESTIGATION
COMMUNICATIONS SECTION
OCT 19 1947

15 2771444Z

DECLASSIFICATION AUTHORITY DERIVED FROM:
FBI AUTOMATIC DECLASSIFICATION GUIDE
DATE 03-05-2023 BY: [redacted]

b6
b7C

Exec. AD-Adm.	
Exec. AD-Inv.	
Exec. AD-LES	
Asst. Dir.:	
Adm. Serv.	
Crim. Inv.	
Ident.	
Intell.	
Laboratory	
Legal Coun.	
Plan. & Insp.	
Rec. Mgnt.	
Tech. Servs.	b6
Training	b7C
Public Affs. Off.	
Telephone Rm.	
Director's Sec'y	

HQ LA MM NK WF SF SJ

DE NY 0001

O 041430Z OCT 7

FM NEW YORK (M-10)

TO DIRECTOR IMMEDIATE

LOS ANGELES IMMEDIATE (VIA FBIHQ)

MIAMI IMMEDIATE

NEWARK IMMEDIATE

WASHINGTON FIELD IMMEDIATE (VIA FBIHQ)

SAN FRANCISCO IMMEDIATE (VIA FBIHQ)

SAN JUAN IMMEDIATE (VIA FBIHQ)

BT

~~SECRET~~

PROPOSED VISIT OF CUBAN PREMIER FIDEL CASTRO TO THE UNITED STATES, OCTOBER 19, 1979, PROTECTION OF FOREIGN OFFICIALS:

OO: NEW YORK.

FOR THE INFORMATION OF THE BUREAU AND RECIPIENT OFFICES, THIS MATTER IS BEING HANDLED BY SQUAD M-10, WHICH HANDLES PROTECTION OF FOREIGN OFFICIAL MATTERS AND TERRORIST BOMBING MATTERS. ALL COMMUNICATIONS AND TELEPHONIC CONTACTS WITH THE

REC-65

EX-109

OCT 15 1979

b3
b6
b7C
b7E

6300

879

TELETYPED

(A C W F S F S J)

RECEIVED TELETYPE UNIT

OCT 79 14 59z

RECEIVED FEDERAL BUREAU OF INVESTIGATION COMMUNICATIONS SECTION

NY
CC/B/A

NYO RELATIVE TO UPCOMING PROPOSED VIOLENCE IN CONNECTION WITH CASTRO'S VISIT SHOULD BE DIRECTED TO SQUAD M-10.

FOR THE INFORMATION OF THE BUREAU AND RECEIVING OFFICES, AT THIS TIME, THE NEW YORK OFFICE IS RECEIVING UNSUBSTANTIATED AND UNCORROBORATED INFORMATION FROM VARIOUS MEMBERS OF THE CUBAN EXILE PRESS COMMUNITY IN THIS AREA IN ADDITION TO THE UNITED STATES SECRET SERVICE AND UNITED STATES STATE DEPARTMENT RELATIVE TO INFORMATION REGARDING THE TRAVEL OF VARIOUS CUBAN EXILES FROM OUTSIDE THE NEW YORK DIVISION TO THIS AREA FOR PROPOSED UPCOMING VIOLENCE.

RECEIVING OFFICES SHOULD BEAR IN MIND THAT THE UNITED STATES SECRET SERVICE HAS PRIMARY RESPONSIBILITY IN THE PROTECTION OF FIDEL CASTRO, AND THAT UNITED STATES SECRET SERVICE IS CURRENTLY RECEIVING INFORMATION ON A IMMEDIATE AND DAILY BASIS FROM ITS OFFICES THROUGHOUT THE UNITED STATES. AS A RESULT OF THIS, THE UNITED STATES SECRET SERVICE IS IN CONSTANT CONTACT WITH THE NYO RELATIVE TO INFORMATION BEING RECEIVED FROM OTHER UNITED STATES SECRET SERVICE OFFICES IN THE UNITED STATES, AND IT IS ABSOLUTELY NECESSARY THAT RECEIVING OFFICES, AFTER

PAGE THREE

~~SECRET~~

PROVIDING ANY INFORMATION OF ANY TYPE TO THE UNITED STATES
SECRET SERVICE IN YOUR DIVISION, IMMEDIATELY FORWARD THIS
INFORMATION TO THE NYO, EITHER TELEPHONICALLY OR BY TELETYPE,
DEPENDING ON THE PRIORITY OF THE MATTER.

AT THIS TIME, THE NYO IS IN POSSESSION OF INFORMATION FROM

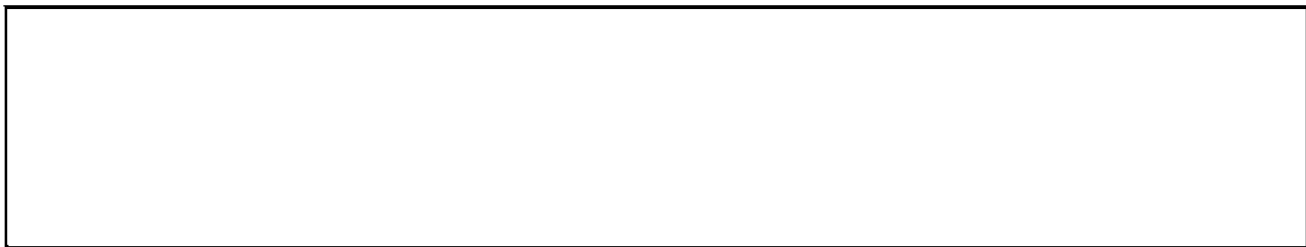

b6
b7C
b7D

 INFORMATION AVAILABLE TO NEW YORK REVEALS

THAT 

IT IS ABSOLUTELY ESSENTIAL THAT SHOULD YOUR DIVISIONS
RECEIVE INFORMATION THAT KNOWN CUBAN EXILE BOMBERS ARE OUT OF
YOUR DIVISION AND CURRENTLY EN ROUTE TO NEW YORK OR ALREADY IN
THIS DIVISION, THAT THIS INFORMATION BE TELEPHONICALLY RELAYED
TO THE NEW YORK OFFICE AND SUBSEQUENTLY FOLLOWED BY IMMEDIATE
TELETYPE.

FOR THE INFORMATION OF MIAMI AND SAN JUAN DIVISION, ON THE
EVENING OF OCTOBER 3, 1979, THE UNITED STATES SECRET SERVICE

PAGE FOUR ~~SECRET~~

AT SAN FRANCISCO TELEPHONICALLY CONTACTED THE NEW YORK OFFICE AND ADVISED THAT THEY HAD CONDUCTED A CONSENT SEARCH AT THE RESIDENCE OF [REDACTED], WITH THE CONSENT OF [REDACTED]

b6
b7C

[REDACTED] AND THAT THEY HAD LOCATED APPARENT AUTOMATIC WEAPONS AND CLAYMOR MINES. THE MIAMI AND SAN JUAN DIVISIONS ARE AWARE OF [REDACTED] SIGNIFICANCE AND THE FACT THAT HE IS ALLEGEDLY TRAVELING TO NEW YORK TO COMMIT AN ACT OF VIOLENCE RELATIVE TO CASTRO'S VISIT. THE LATEST AVAILABLE INFORMATION TO NEW YORK IS THAT [REDACTED] IS CURRENTLY HERE IN NEW YORK CITY AND THAT A RELIABLE SOURCE [REDACTED]

b6
b7C
b7D

facts re this

MIAMI, SAN JUAN, AND SAN FRANCISCO DIVISIONS SHOULD BEAR IN MIND, THAT AS YOUR DIVISIONS ARE AWARE, THE UNITED STATES SECRET SERVICE IS IN POSSESSION OF INFORMATION RELATIVE TO [REDACTED] PROPOSED TRAVEL TO NEW YORK, AND THAT THIS INFORMATION HAS BEEN PROVIDED THEM BY THE FBI. RECEIVING OFFICES SHOULD BEAR IN MIND THAT THE UNITED STATES SECRET SERVICE HAS THE PRIMARY RESPONSIBILITY IN PROTECTING CASTRO, AND THAT THEY ARE APPARENTLY, AT THIS TIME, TAKING WHATEVER ACTION THEY DEEM NECESSARY TO DETERMINE

b6
b7C

PAGE FIVE

~~SECRET~~

THE WHEREABOUTS AND ACTIVITIES OF [] THE NEW YORK OFFICE, FBI, CURRENTLY IS IN CONSTANT CONTACT WITH UNITED STATES SECRET SERVICE HERE, AND UNITED STATES SECRET SERVICE PERSONNEL HERE ARE NOT TAKING ANY ACTION RELATIVE TO [] WITHOUT THE EXPRESSED CONSENT AND APPROVAL OF THE NYO. ALL INVESTIGATION DEEMED APPROPRIATE RELATIVE TO [] HERE IN NEW YORK WILL BE COORDINATED WITH UNITED STATES SECRET SERVICE.

b6
b7C

NEW YORK NOTES AT THIS TIME THAT THE NYO CANNOT CONTROL UNITED STATES SECRET SERVICE OFFICES THROUGHOUT THE UNITED STATES, AND SHOULD THEY RECEIVE INFORMATION RELATIVE TO [] OR ANY ASSOCIATES, THEY MAY ACT UPON THEIR OWN TO CONDUCT ANY APPROPRIATE INVESTIGATION DEEMED NECESSARY.

b6
b7C

THE NEW YORK OFFICE IS COGNIZANT AT THIS TIME THAT THERE IS [] AND THE NYO SUGGESTS THAT MIAMI, SAN JUAN, AND SAN FRANCISCO MAINTAIN CLOSE LIAISON WITH THE UNITED STATES SECRET SERVICE SO THAT SOURCE'S INFORMATION AND ACTIVITIES CAN BE PROTECTED ACCORDINGLY.

b6
b7C
b7D

RECEIVING OFFICES WILL ADVISE THE NYO IF ANY KNOWN CUBAN EXILE BOMBERS ARE CURRENTLY OUT OF YOUR DIVISION AND EITHER TRAVELING TO

PAGE SIX

~~SECRET~~

NEW YORK OR CURRENTLY IN NEW YORK CITY AT THIS TIME.

SAN FRANCISCO DIVISION WILL PROVIDE DETAILS OF SEARCH AT
THE RESIDENCE OF [REDACTED] TO THE NYO, MIAMI, AND SAN JUAN
DIVISIONS.

b6
b7c

SAN JUAN AND MIAMI DIVISIONS WILL KEEP THE NYO ADVISED OF
ANY PROPOSED TRAVEL OF SPECIAL AGENTS AND/OR ASSETS AND SOURCES
FROM YOUR DIVISIONS TO THIS AREA.

ARMED AND DANGEROUS.

~~C AND E 5815, REASON 2, DRO OCTOBER 4, 1999.~~

BT

#

DEPARTMENT OF JUSTICE
FEDERAL BUREAU OF INVESTIGATION
COMMUNICATION MESSAGE FORM

b6
b7c

1 OF 3

10/4/79 CLASSIFICATION ~~SECRET~~ PRECEDENCE IMMEDIATE

#F13400 NK NYDE HQ H0134 #HYS0 042208Z OCT 79

START HERE

FM DIRECTOR FBI
TO FBI NEW YORK IMMEDIATE
FBI NEWARK IMMEDIATE

b6
b7c

14BT

~~SECRET~~

12 PROPOSED VISIT OF CUBAN PREMIER FIDEL CASTRO TO THE U.S., OCTOBER
1979; PFO MATTER; OO:NEW YORK

10 REBUTEL DATED SEPTEMBER 21, 1979. [U]
REFERENCED TELETYPE SPECIFICALLY SET FORTH THE PARAPHRASED
8 INFORMATION WHICH WAS FURNISHED TO U.S. SECRET SERVICE [USSS]

b3
b6
b7c
b7E

UNDER THE CAPTION OF [redacted]

6 THE VERBATIM TRANSMISSION CITED IN RETEL WAS FURNISHED TO RECI-
PIENT OFFICES TO INSURE THAT IN DISCUSSIONS BETWEEN THESE OFFICES
4 AND USSS, NO ADDITIONAL INFORMATION BE FURNISHED USSS. FBIHQ'S
INTENTION IN LIMITING THE AMOUNT OF INFORMATION DISCUSSED WITH
2 USSS WAS OBVIOUSLY TO PROTECT THE HIGHLY SENSITIVE SOURCE,

NOT TYPE PAST THIS LINE

[redacted] ~~SECRET~~ REC-77 185-1241-46
DO NOT TYPE MESSAGE BELOW THIS

b3
b6
b7c
b7D
b7E

APPROVED BY [redacted] DATE 10/4/79 ROOM 4147/5 TELE EXT. 4605

- 1 - [redacted]
- 1 - [redacted]
- 1 - [redacted]
- 1 - [redacted]
- 1 - [redacted]
- 1 - [redacted]

OCT 10 1979
SEE NOTE PAGE 4

ROUTE IN ENVELOPE

FEDERAL BUREAU OF INVESTIGATION
COMMUNICATIONS SECTION

2253
OCT 04 1979

59 OCT 30 1979

DO NOT FILE WITHOUT COMMUNICATIONS STAMP

DEPARTMENT OF JUSTICE
FEDERAL BUREAU OF INVESTIGATION
COMMUNICATION MESSAGE FORM

PAGE 2

CONTINUATION SHEET

~~(PAGERITW0E DE HQ 0134 S E C R E T~~

ON OCTOBER 2, 1979, INFORMATION WAS RECEIVED AT FBIHQ THAT
SECRET SERVICE AGENTS IN MIAMI HAD RECEIVED A TELETYPE FROM SECRET
SERVICE IN NEW YORK WHICH SET FORTH DETAILS REGARDING [REDACTED]
REPORTING INCLUDING [REDACTED]

[REDACTED] THE SUBSTANCE OF THE INFORMATION CURRENTLY
KNOWN BY USSS IN NEW YORK AND MIAMI GOES FAR BEYOND THAT FURN-
ISHED THEM IN THE TRANSMISSION SET FORTH IN RETEL. INASMUCH AS
THIS ADDITIONAL INFORMATION WAS KNOWN ONLY TO THE FBI AND THAT
USSS IN MIAMI BECAME COGNIZANT OF SAME FROM THEIR NEW YORK OFFICE.
IT WOULD APPEAR THAT THEY ACQUIRED THIS ADDITIONAL DATA OF
[REDACTED] REPORTING FROM THEIR RECENT CONTACTS WITH THE FBI IN THE
NEW YORK AND NEWARK AREAS IN CONNECTION WITH CAPTIONED MATTER. ~~IS~~

NEW YORK AND NEWARK WILL IMMEDIATELY ADVISE IN DETAIL ALL
CONTACTS HELD WITH USSS REPS SINCE SEPTEMBER 21, 1979, CONCERNING
CAPTIONED MATTER, DEPTH OF DISCUSSION, AND/OR INFORMATION EX-
CHANGED ON [REDACTED] REPORTING, AND IDENTITIES OF USSS AND FBI PER-
SONNEL SO INVOLVED. RECOMMENDATION SHOULD BE SUBMITTED FOR AD-
MINISTRATIVE ACTION AS APPROPRIATE SINCE FBIHQ REGARDS THIS
SITUATION AS A GROSS VIOLATION OF SPECIFIC INSTRUCTIONS. SUTEL
BY OCTOBER 5, 1979. ~~IS~~

DO NOT TYPE MESSAGE BELOW THIS LINE

DO NOT TYPE PAST THIS LINE

b3
b6
b7C
b7D
b7E

b3
b7D
b7E

DEPARTMENT OF JUSTICE
FEDERAL BUREAU OF INVESTIGATION
COMMUNICATION MESSAGE FORM

PAGE 3

CONTINUATION SHEET

~~PAGE THREE DE HQ 0134 SECRET~~

~~C AND E 5236, REASONS 12, 31, DRD OCTOBER 4, 1999.~~

20 BT

18 I

16

14

12

10

8

6

4

2

DO NOT TYPE PAST THIS LINE

DO NOT TYPE MESSAGE BELOW THIS LINE

10/4/79

~~SECRET~~b6
b7cNOTE:

On 9/21/79, FBIHQ furnished New York and Newark with a verbatim transmission which had been provided Hqtrs, U. S. Secret Service, WCD, concerning recent reporting from Bureau source [redacted] on captioned matter. Both offices were specifically advised that "should they (USSS) wish to discuss matter with you, no other information should be discussed." On 10/2/79, Miami telephonically advised FBIHQ that Miami Secret Service had received a teletype from NY Secret Service which set forth details regarding [redacted] reporting which far exceeded that furnished in retel. Inasmuch as this additional information was known only to the FBI, and that Miami Secret Service learned of same from their NY office, it would appear that they (USSS) acquired the additional data from their recent contacts with the FBI in NY and NK in connection with captioned matter. NY and NK are being instructed to provide detailed information concerning their contacts with USSS in this regard, and as appropriate to submit recommendations for administrative action. (S) (U)

b3
b7D
b7E

[redacted]

b6
b7c

NY 0001 2152256

OO HQ NK

DE NY 0028

0052123Z OCT 79

FM NEW YORK (185-899) (M-10)

TO DIRECTOR IMMEDIATE

NEWARK ROUTINE

BT

~~SECRET~~

PROPOSED VISIT OF CUBAN PREMIER FIDEL CASTRO TO THE UNITED STATES,

OCTOBER, 1979; PFO MATTER; OO: NEW YORK.

REFERENCE BUREAU TELETYPE, DATED OCTOBER 4, 1979.

AS THE BUREAU IS AWARE, ANTI-CASTRO CUBAN EXILES HAVE BEEN INVOLVED IN NUMEROUS BOMBINGS AND OTHER ACTS OF VIOLENCE IN THE NEW YORK AREA, SINCE FEBRUARY, 1975, THERE HAVE BEEN APPROXIMATELY 12 BOMBINGS ATTRIBUTED TO THE ANTI-CASTRO GROUP "OMEGA 7." ONE SUCH BOMBING WAS CARRIED OUT BY ANTI-CASTRO CUBAN EXILES AGAINST THE TRANS WORLD AIRLINES TERMINAL, JOHN F. KENNEDY INTERNATIONAL AIRPORT, WHERE A DEVICE DETONATED ABOARD A BAGGAGE CART MINUTES PRIOR TO TAKEOFF. HAD THIS DEVICE DETONATED MINUTES LATER, THE RESULT WOULD HAVE BEEN THE DEATH OF APPROXIMATELY 187 AMERICAN CITIZENS.

RECEIVED
TELETYPE UNIT

5 OCT 79 23 22z

RECEIVED
FEDERAL BUREAU
OF INVESTIGATION
COMMUNICATIONS SECTION

Exec. AD-Adm.	
Exec. AD-Inv.	
Exec. AD-LES.	
Asst. Dir.:	
Adm.	[redacted]
Crim.	[redacted]
Ident.	[redacted]
Intell.	[redacted]
Laborat.	[redacted]
Legal Coun.	[redacted]
Plan. & Insp.	[redacted]
Rec. Mgmt.	[redacted]
Tech. Serv.	[redacted]
Training	[redacted]
Public Affs. Off.	[redacted]
Telephone Rm.	[redacted]
Director's Sec'y	[redacted]

b6
b7c

b6
b7c

b6
b7c

b3
b6
b7c
b7E

7 OCT 16 1979

60 OCT 25 1979

b6
b7c

ANTI-CASTRO CUBAN EXILES HAVE BEEN RESPONSIBLE FOR NUMEROUS BOMBINGS AT THE CUBAN MISSION TO THE UNITED NATIONS, NEW YORK CITY, AND SUBSEQUENT NEIGHBORHOOD INVESTIGATIONS HAVE DETERMINED THAT INNOCENT BYSTANDERS NARROWLY ESCAPED DEATH OR SERIOUS INJURY, WHICH BYSTANDERS INCLUDED GRADE SCHOOL CHILDREN AND POLICE OFFICERS.

③ IN ADDITION TO THE ABOVE, ANTI-CASTRO CUBAN EXILES WERE DIRECTLY RESPONSIBLE FOR THE BOMBING DEATH IN WASHINGTON, D.C., OF ORLANDO LETELIER AND HIS AIDE, RONNIE MOFFITT, IN SEPTEMBER, 1976, AND THE BOMBING OF A VENEZUELAN AIRLINER IN OCTOBER, 1976, WHICH KILLED APPROXIMATELY 76 PEOPLE.

IN VIEW OF THE ABOVE, THE PROPENSITY FOR VIOLENCE AND TOTAL DISREGARD FOR HUMAN LIFE HAS BEEN WELL DOCUMENTED.

THE PROPOSED VISIT OF FIDEL CASTRO TO THE UNITED STATES, AND SPECIFICALLY NEW YORK, POSES AN IMMEDIATE THREAT TO THE LIVES OF NOT ONLY CUBAN GOVERNMENT PERSONNEL BUT AMERICAN CITIZENS AS WELL. FIDEL CASTRO, REPRESENTATIVES OF HIS GOVERNMENT AND THEIR ESTABLISHMENTS ARE OBVIOUSLY THE FOCAL POINT OF ALL TERRORIST ACTIVITIES PERPETRATED BY CUBAN EXILES IN THE UNITED STATES, AND HIS PROPOSED VISIT AND THE OPPORTUNITY IT REPRESENTS FOR POSSIBLE ACTS RESULTING IN THE DEATH AND DESTRUCTION OF

PAGE THREE ~~SECRET~~

AMERICAN LIVES AND PROPERTY IS BLATANTLY OBVIOUS. IN ESSENCE, FIDEL CASTRO IS "EVERYTHING" THAT CUBAN EXILES HAVE BEEN DIRECTING THEIR VIOLENCE TOWARD SINCE 1961. A VISIT BY FIDEL CASTRO TO THIS COUNTRY POSES A PROBLEM WHEREIN IT ALLOWS THE OPPORTUNITY FOR CUBAN EXILES TO ELIMINATE THE "TYRANT" THAT THEY HAVE HATED FOR APPROXIMATELY 25 YEARS.

THEREFORE, THE NEW YORK OFFICE FOUND IT NECESSARY TO ESTABLISH LIAISON AT AN EARLY DATE WITH THE UNITED STATES SECRET SERVICE AND OTHER FEDERAL, STATE AND LOCAL AGENCIES CONCERNING THE PROPOSED VISIT. THIS PROPOSED VISIT, AS WELL AS THE VISIT OF POPE JOHN PAUL THE SECOND, NECESSITATED DAILY CONTACTS WITH NUMEROUS REPRESENTATIVES OF ALL OF THESE AGENCIES, INCLUDING THE HEADS OF THE VARIOUS AGENCIES.

b6
b7c

IT IS POINTED OUT THAT FOLLOWING BUREAU TELETYPE OF SEPTEMBER 21, 1979, SUBSEQUENT INFORMATION BECAME AVAILABLE THAT THE ALLEGED PERPETRATOR IN THE SCHEME TO KILL CASTRO, NAMELY [REDACTED] SUBSEQUENTLY TRAVELED TO NEW YORK AND WAS IN CONTACT WITH CUBAN EXILES HERE. IT IS NOTED THAT THERE WAS A REASONABLE POSSIBILITY THAT [REDACTED] COULD CHANGE HIS PLANS AND ATTEMPT TO ELICIT ASSISTANCE OF CUBAN EXILES IN NEW YORK AND ACQUIRE

Response

b6
b7c

b6
b7c

PAGE FOUR ~~SECRET~~

*de/evsec
speed!*

ADDITIONAL WEAPONS AND/OR EXPLOSIVES. TO ASSUME THAT

WOULD UTILIZE A WEAPON WHICH WAS LOCATED IN ANOTHER STATE TO THE EXCLUSION OF ALL OTHER AVAILABLE WEAPONS WAS CERTAINLY OPEN TO SERIOUS QUESTION. THE SITUATION INVOLVED AN IMMEDIATE THREAT MADE BY CUBAN EXILES WHO TRAVELED TO NEW YORK. U.S. SECRET SERVICE HAS THE RESPONSIBILITY FOR THE PROTECTION OF FIDEL CASTRO, AND THE FBI HAD AN OBLIGATION TO FURNISH INFORMATION IN THEIR POSSESSION CONCERNING AN IMMEDIATE PLOT. AT NO TIME DID THE NYO DISCUSS WITH U.S. SECRET SERVICE SPECIFIC INFORMATION CONCERNING THE IDENTITY OF THE SOURCE INVOLVED NOR DID THE SECRET SERVICE REQUEST THAT INFORMATION. FURTHER, SECRET SERVICE WAS ADVISED OF THE SENSITIVITY OF THE SITUATION AND THEY ASSURED THE NYO THAT INFORMATION FURNISHED WOULD NOT BE DISSEMINATED OUTSIDE THAT AGENCY. THEY FURTHER ASSURED NYO SPECIAL AGENTS THAT THE INFORMATION WOULD BE DISSEMINATED WITHIN THEIR AGENCY ON A NEED-TO-KNOW BASIS. ALL INFORMATION DISSEMINATED WITHIN SECRET SERVICE WAS DONE SO AT THE CLASSIFICATION IN WHICH IT WAS RECEIVED AT THE NYO OR AT A HIGHER CLASSIFICATION. ASSURANCES WERE ALSO RECEIVED THAT SECRET SERVICE WOULD TAKE NO ACTION IN REGARD TO INSTANT PLOT AGAINST

Copy over!

???

CASTRO, EXCEPT AT THE DIRECTION OF THE FBI. AS THE BUREAU IS AWARE, SECRET SERVICE CONDUCTED ALL SUBSEQUENT INTERVIEWS, ETC., WITH BUREAU AGENTS INVOLVED IN THIS MATTER NATIONWIDE.

FOR INFORMATION PURPOSES, ALTHOUGH ADDITIONAL DETAILS WILL BE PROVIDED IN A SUBSEQUENT COMMUNICATION, [REDACTED] ANDRES SARGEN AND [REDACTED] WERE LOCATED AND INTERVIEWED AT NEW YORK CITY EVENING OF OCTOBER 4, 1979, WITH ASSISTANCE OF U.S. SECRET SERVICE. [REDACTED] AND OTHERS WERE ADVISED THAT INTERVIEW BEING CONDUCTED ON ROUTINE BASIS PER REQUEST OF SECRET SERVICE AND [REDACTED] FULLY COGNIZANT THAT FBI IS AWARE HE AND OTHER EXILES ARE CURRENTLY IN NEW YORK. NO REFERENCE MADE TO ANY PLOT, INTERVIEW CONDUCTED IN GENERAL TERMS, AND ALL EXILES COOPERATIVE. PRIOR TO ABOVE INTERVIEWS, TELEPHONIC CONTACT WAS MADE WITH [REDACTED] [REDACTED] RELATIVE TO ANY POSSIBLE COMPROMISE OF SOURCE AND IT WAS AGREED BY [REDACTED] THAT INTERVIEWS OF [REDACTED] ET AL, COULD BE CONDUCTED BY NYO SPECIAL AGENTS THAT EVENING.

NYO REITERATES THAT ALTHOUGH REFERENCED TELETYPE CONTAINED SPECIFIC INSTRUCTIONS REGARDING DISSEMINATION, SUBSEQUENT INFORMATION DEVELOPED WHICH MADE IT APPEAR THAT THE PLOT MIGHT INDEED MATERIALIZE. IT WAS AT THIS POINT THE NYO

b6
b7c

b6
b7c
b7E

*Original
Index*

unless specified

*Must
question
repercussions
use of
unintended
threat
opposed to a
precipitous
action!*

PAGE SIX ~~SECRET~~

MADE AVAILABLE ONLY ENOUGH INFORMATION TO U.S. SECRET SERVICE
TO HANDLE THE IMMEDIATE THREAT JOINTLY WITH THE NYO.

NEW YORK OFFICE PERSONNEL INVOLVED IN THE ABOVE DISCUSSIONS
WITH U.S. SECRET SERVICE AND SUBSEQUENT JOINT INVESTIGATION WERE

SUPERVISOR [REDACTED] SPECIAL AGENT [REDACTED]

AND SPECIAL AGENT [REDACTED] OF SECTION M-10, MANHATTAN.

SPECIAL AGENT IN CHARGE, CRIMINAL DIVISION, NEW YORK, RECOMMENDS

NO ADMINISTRATIVE ACTION BE TAKEN.

~~C AND E 5815, REASONS 2 AND 3, DRD OCTOBER 5, 1999.~~

BT

b6
b7c

cc: C10

DEPARTMENT OF JUSTICE
FEDERAL BUREAU OF INVESTIGATION
COMMUNICATION MESSAGE FORM

b6
b7c

046

PAGE 1 OF 3		CLASSIFICATION		PRECEDENCE	
DATE 10/6/79		SECRET		IMMEDIATE	
#F04600 CG LA MM NK NO*Y SF SJ WFODE HQ H0046 #H					
HSMO RT 06-1704Z OCT 79					
FM	FM DIRECTOR FBI		DECLASSIFICATION AUTHORITY DERIVED FROM: FBI AUTOMATIC DECLASSIFICATION GUIDE DATE 03-09-2023 BY []		
TO	TO FBI NEW YORK IMMEDIATE				
	FBI WASHINGTON FIELD PRIORITY				
14	FBI SAN FRANCISCO PRIORITY				
	FBI LOS ANGELES PRIORITY				
12	FBI CHICAGO PRIORITY				
	FBI MIAMI PRIORITY				
10	FBI SAN JUAN PRIORITY				
	FBI NEWARK PRIORITY				
8	BT				
	SECRET				
6	PROPOSED VISIT OF CUBAN PREMIER FIDEL CASTRO TO THE U.S., OCTOBER, 1979; PFO MATTER; OO: NEW YORK.				
4	ON OCTOBER 5, 1979, U.S. DEPARTMENT OF STATE (USDS) ADVISED FBIHQ THAT FIDEL CASTRO WILL BE COMING TO THE U.S. TO ADDRESS THE UNITED NATIONS AND WILL ARRIVE IN NEW YORK ON OCTOBER 10, 1979. USDS FURTHER ADVISED THAT THERE WOULD BE A				
2	DO NOT TYPE PAGE BELOW THIS LINE				
APPROVED BY []		DRAFTED BY []		DATE 10/6/79	ROOM 4147/5
[]		[]		TELE EXT. 46	[]

DO NOT TYPE PAST THIS LINE

b6
b7c

b3
b6
b7c
b7E

105-1241-48

OCT 9 1979

FEDERAL BUREAU OF INVESTIGATION
COMMUNICATIONS SECTION
18572
OCT 06 1979

b6
b7c

60 9791

DO NOT FILE WITHOUT COMMUNICATIONS STAMP

DEPARTMENT OF JUSTICE
FEDERAL BUREAU OF INVESTIGATION
COMMUNICATION MESSAGE FORM

PAGE 2

CONTINUATION SHEET

~~PAGE RT HQ DE HQ 0046 SECRET~~

20 TOTAL NUMBER OF 206 PERSONS TRAVELLING FROM CUBA TO NEW YORK ON
 18 THREE SPECIAL FLIGHTS IN CONNECTION WITH CASTRO'S VISIT. THE
 16 FIRST FLIGHT IS SCHEDULED TO ARRIVE NEW YORK ON SUNDAY, OCTOBER
 14 7, 1979; THE SECOND FLIGHT IS SCHEDULED TO ARRIVE NEW YORK ON
 12 TUESDAY, OCTOBER 9, 1979; AND THE THIRD FLIGHT ON WHICH CASTRO
 10 WILL TRAVEL IS SCHEDULED TO ARRIVE NEW YORK ON WEDNESDAY,
 8 OCTOBER 10, 1979. ON OCTOBER 6, 1979, U.S. SECRET SERVICE
 6 {USSS} HEADQUARTERS, WASHINGTON, D. C., ADVISED FBIHQ THAT THEY
 4 HAD BEEN ADVISED THAT THE FIRST FLIGHT SCHEDULED TO ARRIVE NEW
 YORK, OCTOBER 7, 1979, WOULD CARRY CASTRO'S SECURITY PERSONNEL
 AS WELL AS MEDICAL EQUIPMENT. USSS STATED THAT CASTRO'S
 SECURITY PEOPLE WOULD BE ARMED, HOWEVER, INSTRUCTIONS HAVE BEEN
 FURNISHED BY USSS TO THE U.S. INTEREST SECTION IN HAVANA THAT
 NO ONE IN THIS CONTINGENT CARRYING AUTOMATIC OR SHOULDER WEAPONS
 WOULD BE ALLOWED TO ENTER THE U.S. USSS ADVISED THAT THEY WOULD
 INITIATE LIAISON WITH CASTRO'S SECURITY DETAIL UPON ITS
 ARRIVAL IN THE U.S. ~~(S)~~ (U)

DO NOT TYPE PAST THIS LINE



DO NOT TYPE MESSAGE BELOW THIS LINE

b3
b7E

DEPARTMENT OF JUSTICE
FEDERAL BUREAU OF INVESTIGATION
COMMUNICATION MESSAGE FORM

PAGE 3

CONTINUATION SHEET

PAGE THREE DE HQ 0046 ~~SECRET~~

b3
b7E

20

18

~~SECRET~~ (U)

16

LIAISON SHOULD BE INITIATED BY NEW YORK WITH APPROPRIATE
U.S. CUSTOMS AND INS PERSONNEL TO OBTAIN FULL NAME AND

14

IDENTIFYING DATA FOR ALL THOSE INDIVIDUALS ARRIVING IN NEW YORK
ON THE THREE AFOREMENTIONED FLIGHTS. ~~SECRET~~ (U)

12

WFO IS INSTRUCTED TO INSURE THAT

b3
b7E

10

~~SECRET~~ (U)

DO NOT TYPE PAST THIS LINE

8

RECIPIENT OFFICES ARE TO INSURE THAT FBIHQ AND NEW YORK ARE
IMMEDIATELY ADVISED OF ANY INFORMATION OR SIGNIFICANT

6

DEVELOPMENTS IN THEIR DIVISION WHICH IS PERTINENT TO FBI AND
USSS RESPONSIBILITIES IN CONNECTION WITH CASTRO'S VISIT.

4

~~C & E 5236, REASON 2 & 3, DRD OCTOBER 6, 1999.~~

BT

2

DO NOT TYPE MESSAGE BELOW THIS LINE

PAGE FOUR

NOTE: ON 10/5/79, USDS ADVISED FBIHQ THAT FIDEL CASTRO WOULD BE COMING TO NEW YORK ON 10/10/79. CASTRO WILL BE BRINGING WITH HIM 206 INDIVIDUALS WHO WILL BE ARRIVING IN NEW YORK ON THREE SPECIAL FLIGHTS DUE INTO NEW YORK ON 10/7/79, 10/9/79, AND 10/10/79, THE LAST ONE CARRYING CASTRO. THIS COMMUNICATION INSTRUCTS NEW YORK AND WFO TO [REDACTED]

[REDACTED]

(X) 10

b3
b7E

[REDACTED]
[REDACTED] was [REDACTED] [REDACTED] [REDACTED]
of above at 10/6/79.
[REDACTED]

b6
b7C

052

MESSAGE RELAY VIA TELETYPE

053

054

DATE 10/6/79	CLASSIFICATION CONFIDENTIAL	PRECEDENCE PRIORITY
-----------------	---	------------------------

FM DIRECTOR FBI

TO FBI NEW YORK

b3
b6
b7C
b7E

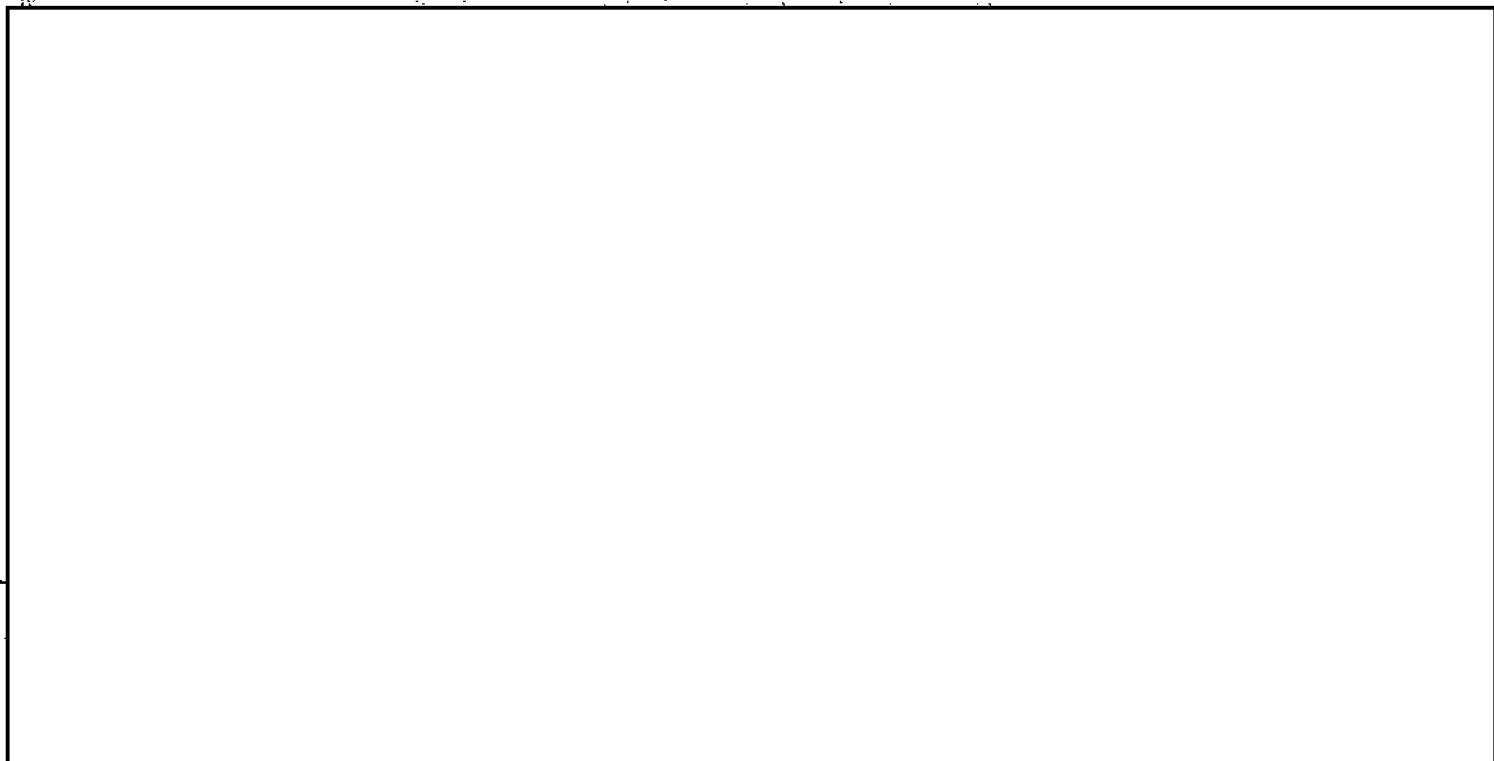

(SERVICE ALSO AVAILABLE TO GOVERNMENT AGENCIES NOT LISTED.
CONTACT COMMUNICATIONS CENTER FOR ADDRESSING INFORMATION)

185-1241-77

SUBJECT: PROPOSED VISIT OF CUBAN PREMIER FIDEL
CASTRO TO THE UNITED STATES, OCTOBER
1979; PROTECTION OF FOREIGN OFFICIAL MATTER

EX-10 REC 20

APPROVED BY [Signature]	ORIGINATOR [redacted]	ROOM 4147	TELE EXT. 4608
----------------------------	--------------------------	--------------	-------------------

29 OCT 9 1979

b3
b6
b7C
b7E

FEDERAL BUREAU OF INVESTIGATION
COMMUNICATIONS SECTION

0058 E
OCT 07 1979

60

DO NOT FILE WITHOUT COMMUNICATIONS STAMP

USE OF FORM 0-73

1. Only incoming teletype messages which require transmission relay may be prepared for transmission using form 0-73. Use of form 0-73 is restricted to incoming teletype messages received within the last 3 days which require transmission relay; all other teletype messages must be prepared using form 0-93.
2. Additions such as notes and administrative data for a specific addressee are not allowed. If a note or administrative data is required for a particular addressee a separate 0-73 form must be prepared.
3. The message will be transmitted just as it appears. The person approving the message is solely responsible for assuring all necessary editing changes have been made.

PREPARATION OF FORM WHICH CONSISTS OF A PREPRINTED YELLOW.

1. Complete appropriate boxes: date, classification & precedence.
2. List addresses immediately following the "TO" or place a check mark in the appropriate boxes.
3. Type or PRINT the subject in the space provided.
4. Print or type originator's name, room number and telephone extension.
5. Indicate approval for transmission by initialing the "Approved By" box.

PREPARATION OF MESSAGE TO BE TRANSMITTED

1. Xerox 1 copy of incoming teletype message. A notation shall be made on the original incoming teletype "1 copy made for relay to SACS _____, (OR LEGATS) _____, (OR GOVERNMENT AGENCIES) _____".
2. Minor editing changes shall be made on the xerox as follows: using a lead pencil ONLY draw single line through the first and last lines of the heading and connect these lines from top right to bottom left forming a "Z," figure. (DO NOT OBLITERATE THE HEADING.) Use horizontal lines to delete sentences or words. Printed changes of a word or two to the text of the message may be made; however, changes to the existing text involving more than a word or two necessitate the originator to initiate a new message using form 0-93.
3. Administrative data or notes may be typed immediately following the text and will be transmitted to all addressees.
4. When using the 0-73 form to disseminate information to field offices, Legal Attaches and other Government agencies simultaneously, the text, notes and administrative data must be identical for all addressees.

RECEIVED
FEDERAL BUREAU
OF INVESTIGATION
COMMUNICATIONS

6 OCT 79 1 07

RECEIVED
TELETYPE UNIT

6 OCT 79 16 30z

RECEIVED
FEDERAL BUREAU
OF INVESTIGATION
COMMUNICATIONS SECTION

Exec. AD-Adm.	
Exec. AD-Inv.	
Exec. AD-LES	
Asst. Dir.:	
Adm. Serv.	
Crim. Inv.	
Ident.	
Insp.	
Laboratory	
Legal Coun.	
Plan. & Insp.	
Rec. Mgmt.	
Tech. Servs.	
Training	
Public Affs. Off.	
Telephone Rm.	
Director's Sec'y	

NY055 2801540

RR HQ MM NK SJ

DE NY 0055

R 061505Z OCT 79

FM NEW YORK (185-899)

TO DIRECTOR ROUTINE

MIAMI ROUTINE

NEWARK ROUTINE

SAN JUAN ROUTINE SAN JUAN VIA HQ

BT

E F T O

PROPOSED VISIT OF CUBAN PREMIER FIDEL CASTRO TO THE
UNITED STATES, OCTOBER, 1979; PFO MATTER; OO:NEW YORK

ON OCTOBER 5, 1979, A LARGE DEMONSTRATION WAS HELD BY APPROXIMATELY 2,500 PERSONS DIRECTLY ACROSS FROM THE UNITED NATIONS AT EAST 47TH STREET AND FIRST AVENUE, NEW YORK CITY. PURPOSE OF THE DEMONSTRATION AS STATED BY NUMEROUS SIGNS AND SPEAKERS WAS TO PROTEST PRESENCE OF RUSSIAN TROOPS AND ADVISORS IN CUBA AND TO PROTEST CUBA'S INTERNATIONAL POLICIES. NO VIOLENCE OCCURRED DURING THE DEMONSTRATION WHICH LASTED FROM 10:00 AM TO 2:00 PM

WPR
Dothron
Custom
FAX
DOS
EPC

REC-120

185-1241-50

OCT 11 1979

TELETYPE

64 OCT 20 1979

b6
b7C

b3
b6
b7C
b7E

b6
b7C

b3
b6
b7C
b7E

b6
b7C

PAGE TWO E F T O

NYO AGENTS, IN COORDINATION WITH NYCPD INTELLIGENCE DIVISION PERIODICALLY OBSERVED DEMONSTRATION IN VIEW OF REPORTS OF POSSIBLE VIOLENCE AND IN VIEW OF INFORMATION THAT [REDACTED] A BUREAU FUGITIVE WANTED FOR

b6
b7C

[REDACTED]
MIGHT ATTEND.

NYO AGENTS OBSERVED [REDACTED]

b6
b7C

[REDACTED] AND A KNOWN CUBAN NATIONALIST MOVEMENT MEMBER.

AND [REDACTED] NYCPD

DETECTIVES ADVISED THEY OBSERVED [REDACTED]

ANTI-CASTRO ACTIVIST.

NYO AGENTS ALSO OBSERVED [REDACTED]

b6
b7C

[REDACTED] ALSO KNOWN ANTI-CASTRO ACTIVISTS.

THE DEMONSTRATION APPEARED TO BE DIRECTED BY ALPHA 66 AND ABDALLA, BOTH KNOWN ANTI-CASTRO ORGANIZATIONS AS THE MAJORITY OF SIGNS AND SPEAKERS MENTIONED THESE GROUPS. SIGNS ALSO REFLECTED THE NAME OF BRIGADE 2506, A KNOWN ANTI-CASTRO ORGANIZATION.

FOR THE INFORMATION OF ALL OFFICES, A UNIFORMED NYCPD OFFICER ADVISED NYO SPECIAL AGENTS THAT HE OVERHEARD AN UNKNOWN

PAGE THREE ~~SECRET~~

CUBAN MALE STATE WORDS TO THE EFFECT THAT SEVERAL ANTI-CASTRO MEMBERS FROM MIAMI WERE IN ATTENDANCE AT THE DEMONSTRATION.

AFTER ANTI-CASTRO DEMONSTRATION, A GROUP OF APPROXIMATELY 250 PERSONS DEMONSTRATED ACROSS FROM THE UNITED NATIONS AT EAST 42ND STREET AND FIRST AVENUE FROM APPROXIMATELY 3:00 PM TO 6:00 PM. THIS GROUP CARRIED SIGNS IN SUPPORT OF THE CUBAN GOVERNMENT POLICIES AND AGAINST UNITED STATES TROOPS BEING STATIONED AT GUANTANAMO BAY, CUBA. NO VIOLENCE OCCURRED DURING THIS DEMONSTRATION WHICH WAS NOT OBSERVED BY NYO AGENTS.

BT

b6
b7C

Exec. AD-Adm.	
Exec. AD-LES	
Asst. Dir.:	
Adm.	
Comp.	
Ident.	
Insp.	
Intell.	
Lab.	
Legal Coun.	
Plan. & Insp.	
Rec. Mgmt.	
Tech. Servs.	
Training	
Public Affs. Off.	
Telephone Rm.	
Director's Sec'y	

RECEIVED
TELETYPE UNIT

6 OCT 79 01 28z

RECEIVED
FEDERAL BUREAU
OF INVESTIGATION
COMMUNICATIONS SECTION

NY0108 2790108

OO HQ CG MM NK HI WF

DE NY 0052

0050013Z OCT 79

FM NEW YORK (185-899) (M-10)

TO DIRECTOR IMMEDIATE

CHICAGO IMMEDIATE

MIAMI IMMEDIATE

NEWARK IMMEDIATE

SAN JUAN IMMEDIATE (VIA FBIHQ)

WASHINGTON FIELD IMMEDIATE (VIA FBIHQ)

BT

~~CONFIDENTIAL~~

PROPOSED VISIT OF CUBAN PREMIER FIDEL CASTRO TO THE UNITED STATES, OCTOBER, 1979; PFO MATTER; OO: NEW YORK.

THIS TELETYPE IS CLASSIFIED ~~CONFIDENTIAL~~ IN THAT INFORMATION HEREIN HAS NOT YET BEEN RELEASED BY UNITED STATES DEPARTMENT OF STATE OR UNITED STATES SECRET SERVICE.

ON OCTOBER 5, 1979, SPECIAL AGENT [redacted] UNITED STATES SECRET SERVICE, NEW YORK, NEW YORK, ADVISED THAT HIS AGENCY HAD RECEIVED INFORMATION FROM UNITED STATES DEPARTMENT OF STATE THAT CUBAN PREMIER FIDEL CASTRO WILL ARRIVE IN NEW

6 OCT 10 1979

b6
b7C

b6
b7C

b3
b6
b7C
b7E

b6
b7C

105-124-51

[redacted]

05 1979

[redacted]

ILL
ST
[handwritten marks]

AGE TWO ~~CONFIDENTIAL~~

mal-tain
when repaired
11/29/79

b6
b7c

YORK CITY EITHER TUESDAY NIGHT, OCTOBER 9, 1979, OR WEDNESDAY, OCTOBER 10, 1979. HE FURTHER ADVISED THAT AT 6:15 PM, OCTOBER 5, 1979, AN ADVANCE PARTY OF CUBAN PERSONNEL WILL ARRIVE AT JFK INTERNATIONAL AIRPORT. ON OCTOBER 7, 1979 (NO TIME GIVEN), A SECOND ADVANCE PARTY WILL ARRIVE AT JFK INTERNATIONAL AIRPORT.

C AND E 5815, REASON 2, DRD OCTOBER 5, 1999.

BT

cc: C10

DEPARTMENT OF JUSTICE
FEDERAL BUREAU OF INVESTIGATION
COMMUNICATION MESSAGE FORM

006

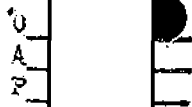

PAGE 1 OF 12

DATE 10/8/79	CLASSIFICATION UNCLAS EFTO	PRECEDENCE ROUTINE
-----------------	-------------------------------	-----------------------

*FDDBRR CG LA MM NK NY SF SJ WFDE HQ H0006 *H04EOR 082257Z OCT 79

START HERE

FM DIRECTOR FBI

TO FBI NEW YORK ROUTINE

FBI MIAMI ROUTINE

14 FBI NEWARK ROUTINE

FBI SAN JUAN ROUTINE

12 FBI WASHINGTON FIELD ROUTINE

FBI LOS ANGELES ROUTINE

10 FBI CHICAGO ROUTINE

FBI SAN FRANCISCO ROUTINE

THIS LINE

b6
b7c

BT
UNCLAS E F T O SECTION 1 OF 2

6 CAZVIZA PFO: 00:NEW YORK

CAPTIONED CODE WORD HAS BEEN ASSIGNED TO VISIT BY CUBAN

4 PREMIER FIDEL CASTRO RUZ TO UNITED NATIONS, NEW YORK. U.S.

DEPARTMENT OF STATE {USDS} ADVISED OCTOBER 5, 1979, CUBAN

2 PREMIER CASTRO WILL VISIT UNITED NATIONS, ARRIVING OCTOBER 10,

1979. ARRIVAL TIME AND LENGTH OF STAY NOT KNOWN. IT IS

105-1241-53

DO NOT TYPE MESSAGE BELOW THIS LINE

APPROVED BY <i>[Signature]</i>	DRAFTED BY [Redacted]	DATE 10/8/79	PROCESSED BY 4775	4685
-----------------------------------	--------------------------	-----------------	----------------------	------

OCT 11 1979

b3
b6
b7c
b7E

SEE NOTE PAGE 13

- 1 - [Redacted]
- 1 - [Redacted]
- 1 - [Redacted]
- 1 - [Redacted]
- 1 - [Redacted]
- 1 - [Redacted]

FEDERAL BUREAU OF INVESTIGATION
COMMUNICATIONS SECTION
OCT 09 1979

64 0

DEPARTMENT OF JUSTICE
FEDERAL BUREAU OF INVESTIGATION
COMMUNICATION MESSAGE FORM

PAGE 2

CONTINUATION SHEET

PAGE TWO DE HQ UNCL**PAGE TWO DE HQ 006**0006 UNCLAS E F T O

EXPECTED CASTRO WILL ADDRESS UNITED NATIONS OCTOBER 12, 1979.

CASTRO WILL RESIDE AT CUBAN MISSION TO THE UNITED NATIONS (CMUN)

IN NEW YORK DURING VISIT.

ON OCTOBER 6, 1979, [REDACTED]

b7E

DO NOT TYPE PAST THIS LINE

b6
b7C
b7E

PAGE 13

UNCLAS EFTO

NOTE:

Addressees furnished above as received from SA USSSHQ, on 10/8/79, during coordination between USSS, CID and INTD at FBIHQ. Teletype coordinated between CID and INTD.

b6
b7c

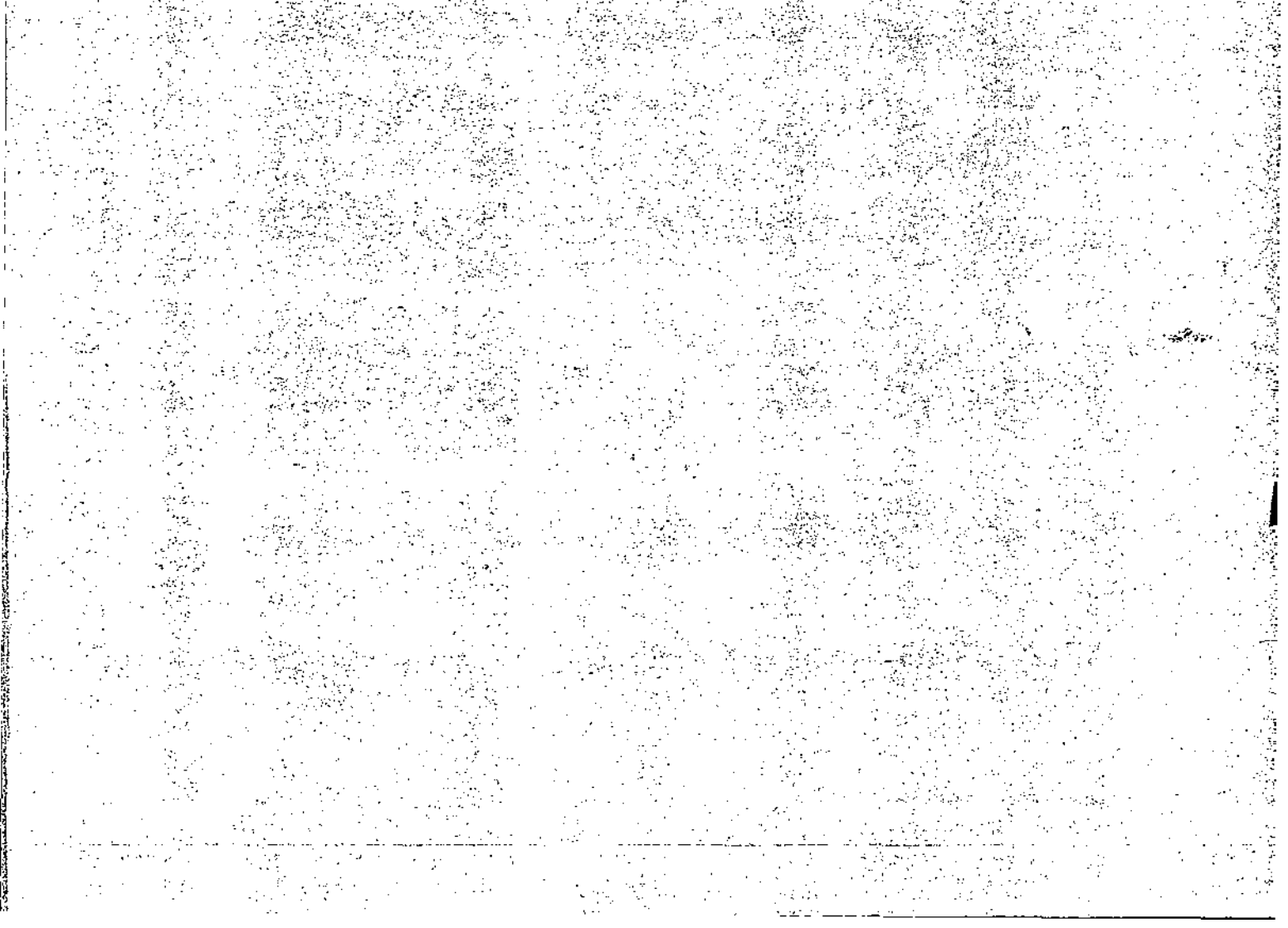

Exec AD Adm. b6
Exec AD Inv. b6
Exec AD LES b7C
Asst. Dir. [redacted]
Adm. [redacted]
Crim. [redacted]
Ident. [redacted]
Intell. [redacted]
Labor. [redacted]
Legal Coun. [redacted]
Plan. & Insp. [redacted]
Rec. Mgnt. [redacted]
Tech. Servs. [redacted]
Training [redacted]
Public Affs. Off. [redacted]
Telephone Rm. [redacted]
Director's Sec'y [redacted]

UNITED STATES GOVERNMENT
Memorandum

UNITED STATES DEPARTMENT OF JUSTICE
FEDERAL BUREAU OF INVESTIGATION
~~SECRET~~

TO : [redacted]
FROM : [redacted]
SUBJECT: CAZVIZ; PFO

DATE: 10/8/79

visit of Cuban Premier Fidel Castro to
PURPOSE: *the UNITED STATES*
To furnish details of briefing of U.S. Secret Service (USSS). (U)

RECOMMENDATION:

None. For information only. (U)

APPROVED: [redacted]
Director [redacted]
Exec. AD-Inv. [redacted]
Exec. AD-Adm. [redacted]
Exec. AD-LES [redacted]
Adm. Serv. [redacted]
Crim. Inv. [redacted]
Ident. [redacted]
Intell. [redacted]
Laborator. [redacted]
Legal Coun. [redacted]
Plan. & Insp. [redacted]
Rec. Mgnt. [redacted]
Tech. Servs. [redacted]
Training [redacted]
Public Affs. Off. [redacted]

DETAILS:

REC-126 V-11 DE-33 [redacted] 185-1244-54

Captioned code word has been assigned to PFO case re visit of Cuban Premier Fidel Castro to the UN beginning 10/10/79. On 10/8/79, a meeting was held between representatives of USSS Headquarters and FBIHQ at FBIHQ. SAs [redacted] represented USSS. FBIHQ representatives were Assistant Section Chief [redacted] CI-2 Section, and SAs [redacted] and [redacted] CI-2-D. SA [redacted] represented CID. The Secret Service was briefed on information received from [redacted] re a plot to assassinate Castro. They were advised that [redacted]

[redacted]

[redacted] (7) [redacted]

1 - [redacted]
1 - [redacted]
1 - [redacted]
1 - [redacted]
1 - [redacted]
1 - [redacted]
1 - [redacted]

~~SECRET~~
CLASS. & EXT. BY 5236
REASON - FCIM II, 1-2.4.2 (2)
DATE OF REVIEW 10/8/99

CONTINUED - OVER



NOV 20 1979

~~SECRET~~

Memorandum to [redacted]
RE: CAZVIZ

b6
b7C

[redacted]

b3
b6
b7C
b7D
b7E

[redacted] They agreed to take no unilateral action with regard to this plot and stated that any proposed investigative action would be coordinated with the FBI. They will not furnish this information to the NYCPD. The USSS representatives were told that the preceding involved a sensitive source and that no dissemination could be made and they advised they would comply. ~~(S)~~ (U)

SA [redacted] advised that they have had contact with the Cuban Security Detail and have been told that Castro will arrive sometime on 10/10/79 and will stay at the CMUN. The time of his arrival is not known although the Cuban Security Detail has mentioned the possibility of a night arrival. The duration of Castro's stay is not known nor is his schedule. [redacted]

b6
b7C
b7E

[redacted] SA [redacted] had previously furnished a typewritten list of individuals and groups posing a threat to Castro [redacted]

[redacted] This information has been relayed to Secret Service field offices by teletype and they will effect interview coordination with our field offices. The same information was sent to appropriate FBI field offices by teletype on 10/8/79. (U)

CONTINUED - OVER

~~SECRET~~

- 2 -

* On the afternoon of 10/10/79 Sup. [redacted] telephonically instructed the Secret Service to furnish the information to the NY P.D. 10/10/79 [redacted]

b6
b7C

~~SECRET~~

Memorandum to [redacted]
RE: CAZVIZ

b6
b7C

Analysis of the information furnished [redacted]

[redacted]
[redacted] and
[redacted] were previously interviewed re their prior anti-Castro activities. [redacted] and Andres Nazario Sargen will be reinterviewed by a joint USSS/FBI team prior to Castro's arrival. (S) (U)

b3
b6
b7C
b7D
b7E

~~SECRET~~

MESSAGE RELAY VIA TELETYPE

046

DATE 10/9/79	CLASSIFICATION UNCLAS	PRECEDENCE ROUTINE
-----------------	--------------------------	-----------------------

FM DIRECTOR FBI

TO

FEDERAL GOVERNMENT

old page 3

b3
b6
b7C
b7E

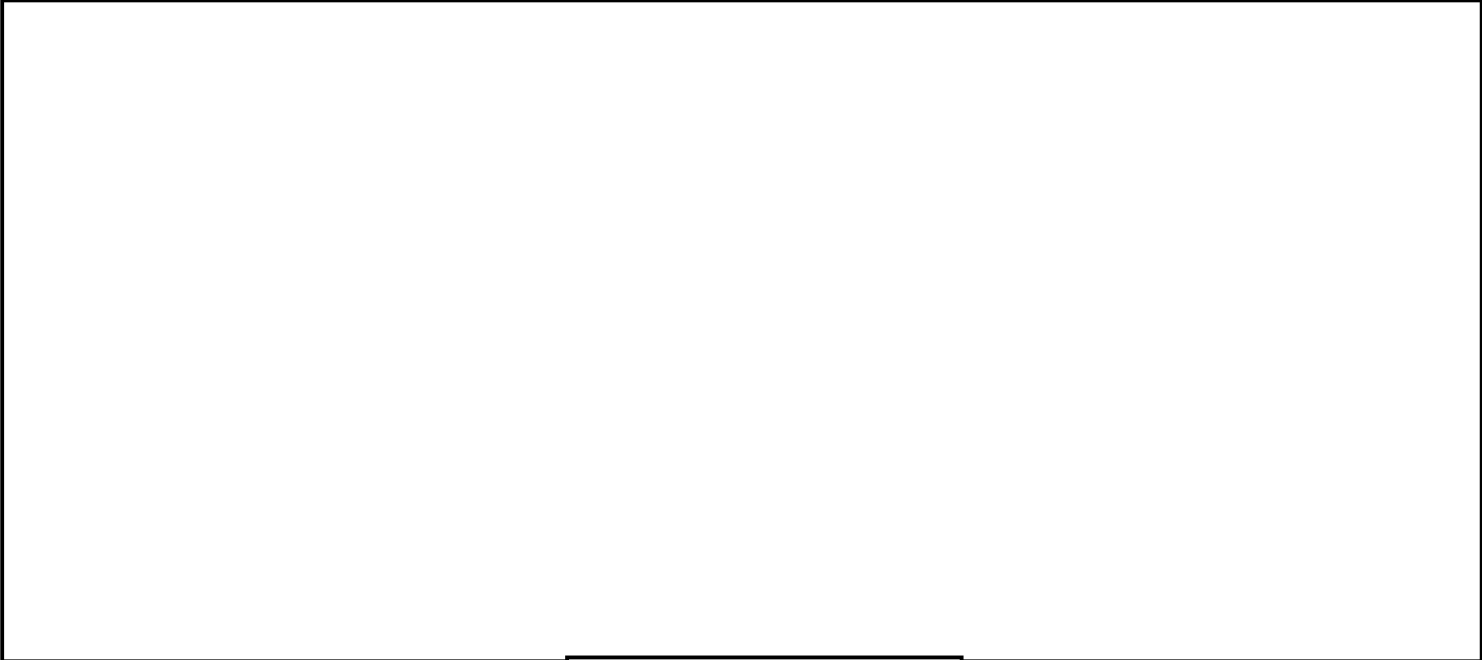

185-1241-35

(SERVICE ALSO AVAILABLE TO GOVERNMENT AGENCIES NOT LISTED
CONTACT COMMUNICATIONS CENTER FOR ADDRESSING INFORMATION)
SUBJECT:

REC-20

b3
b7E

EX-109

OCT 10 1979

APPROVED BY	ORIGINATOR	ROOM 4048	TELE EXT. 4660
-------------	------------	--------------	-------------------

b6
b7C

FEDERAL BUREAU OF INVESTIGATION
COMMUNICATIONS SECTION
OCT 09 1979

6-
61979
q/e

USE OF FORM 0-73

1. Only incoming teletype messages which require transmission relay may be prepared for transmission using form 0-73. Use of form 0-73 is restricted to incoming teletype messages received within the last 3 days which require transmission relay; all other teletype messages must be prepared using form 0-93.
2. Additions such as notes and administrative data for a specific addressee are not allowed. If a note or administrative data is required for a particular addressee a separate 0-73 form must be prepared.
3. The message will be transmitted just as it appears. The person approving the message is solely responsible for assuring all necessary editing changes have been made.

PREPARATION OF FORM WHICH CONSISTS OF A PREPRINTED YELLOW.

1. Complete appropriate boxes: date, classification & precedence.
2. List addresses immediately following the "TO" or place a check mark in the appropriate boxes.
3. Type or PRINT the subject in the space provided.
4. Print or type originator's name, room number and telephone extension.
5. Indicate approval for transmission by initialing the "Approved By" box.

RECEIVED
FEDERAL BUREAU
OF INVESTIGATION
COMMUNICATION SECTION
OCT 19 1953

PREPARATION OF MESSAGE TO BE TRANSMITTED

1. Xerox 1 copy of incoming teletype message. A notation shall be made on the original incoming teletype "1 copy made for relay to SACS _____, (OR LEGATS) _____, (OR GOVERNMENT AGENCIES) _____."
2. Minor editing changes shall be made on the xerox as follows: using a lead pencil ONLY draw single line through the first and last lines of the heading and connect these lines from top right to bottom left forming a "Z," figure. (DO NOT OBLITERATE THE HEADING.) Use horizontal lines to delete sentences or words. Printed changes of a word or two to the text of the message may be made; however, changes to the existing text involving more than a word or two necessitate the originator to initiate a new message using form 0-93.
3. Administrative data or notes may be typed immediately following the text and will be transmitted to all addressees.
4. When using the 0-73 form to disseminate information to field offices, Legal Attaches and other Government agencies simultaneously, the text, notes and administrative data must be identical for all addressees.

NK0009 2822140

PP HQ CG LA MM NY SF SJ WF

DE NK

P 092140Z OCY 79

FM NEWARK (185-122) (P) (C-3)

TO DIRECTOR (PRIORITY)

CHICAGO (PRIORITY)

LOS ANGELES (PRIORITY)

MIAMI (PRIORITY)

NEW YORK (PRIORITY)

SAN FRANCISCO (PRIORITY)

SAN JUAN (VIA FBIHQ) (PRIORITY)

WFO (PRIORITY)

BT

UNCLAS E F T O

CAZVIZ; PFO; OO: NEW YORK

RE BUREAU TELETYPE TO NEW YORK, OCTOBER 8, 1979.

NEWARK HAS REVIEWED RETEL PER INFORMATION [REDACTED]

[REDACTED] ON OCTOBER 6, 1979. MUCH OF THIS INFORMATION

IS DATED, MISLEADING AND COULD CAUSE UNNECESSARY WORK BY THE FIELD IF NOT CLARIFIED. FOR THIS REASON, NEWARK IS PROVIDING THE FOLLOWING ITEM BY ITEM ASSESSMENT AND RECOMMENDS INTERESTED OFFICES DO THE SAME.

23 OCT 12 1979

66
IMPL
79

RECEIVED
TELETYPE UNIT

9 OCT 79 21 58 z

RECEIVED
FEDERAL BUREAU
OF INVESTIGATION
COMMUNICATIONS SECTION

Exec. AD-Inv.	_____
Exec. AD-Adm.	_____
Exec. AD-LES	_____
Asst. Dir.:	
Adm. Servs.	_____
Crim. Inv.	_____
Ident.	_____
Intell.	_____
Laboratory	_____
Legal Coun.	_____
Plan. & Insp.	_____
Rec. Mgnt.	_____
Tech. Servs.	_____
Training	_____
Public Affs. Off.	_____
Telephone Rm.	_____
Director's Sec'y	_____

b6
b7C

2
b6
b7C

b7E

b3
b6
b7C
b7E

Exec. AD-Inv.	_____
Exec. AD-Adm.	_____
Exec. AD-LES.	_____
Asst. Dir.:	
Adm. Servs.	_____
Crim. Inv.	_____
Ident.	_____
Intell.	_____
Laboratory	_____
Legal Coun.	_____
Plan. & Insp.	_____
Rec. Mgnt.	_____
Tech. Servs.	_____
Training	_____
Public Affs. Off.	_____
Telephone Rm.	_____
Director's Sec'y	_____

b6
b7C

RECEIVED
TELETYPE UNIT

9 OCT 79 21 23z
[redacted]
RECEIVED
FEDERAL BUREAU
OF INVESTIGATION
COMMUNICATIONS SECTION

CG0005 2822104
PP HI LA NK NY MM SF SJ WF
DE CG
P 092104Z OCT 79
FM CHICAGO (185-217) (P)
TO DIRECTOR PRIORITY
LOS ANGELES PRIORITY
NEWARK PRIORITY
NEW YORK PRIORITY
MIAMI PRIORITY
SAN FRANCISCO PRIORITY
SAN JUAN PRIORITY
WFO PRIORITY
BT

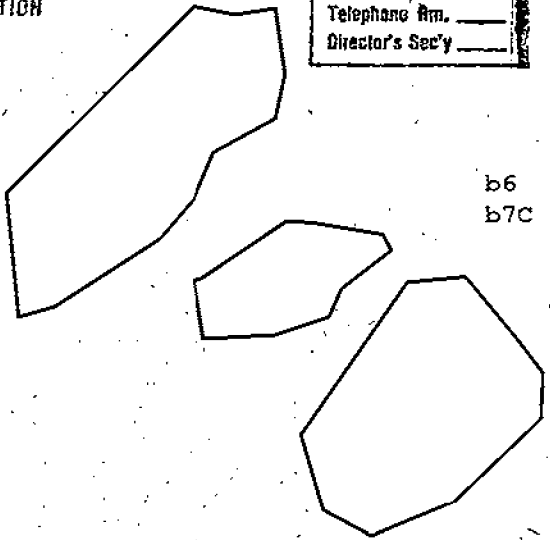

b6
b7C

~~CONFIDENTIAL~~

CAZVIZ; PFO; OO: NEW YORK.

185-1241-57

RE CHICAGO TELETYPE TO SAN JUAN ONLY DATED SEPTEMBER 17, [redacted] b3
1979 CAPTIONED, [redacted] b6
BUREAU TELETYPE TO NEW YORK AND OTHER OFFICES DATED OCTOBER 8, [redacted] b7C
1979 CAPTIONED AS ABOVE. (U) [redacted] b7E

AS A MATTER OF BACKGROUND FOR OFFICES NOT IN PREVIOUS [redacted] OCT 11 1979

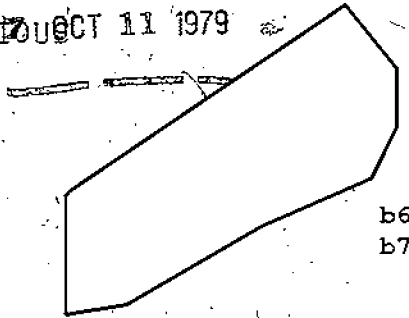

b6
b7C

64 [redacted] 979

TELETYPE UNIT
ST

PAGE TWO

CG 185-217

~~CONFIDENTIAL~~

RECEIPT OF REFERENCED CHICAGO COMMUNICATION, ON SEPTEMBER 17,

1979, [REDACTED]

b6
b7C
b7D

[REDACTED]

(PROTECT IDENTITY BY REQUEST), ADVISED AS FOLLOWS:

b6
b7C
b7D

[REDACTED]

ON SEPTEMBER 17, 1979, [REDACTED]

~~(S)~~ (U)

b6
b7C
b7D



b6
b7C
b7D



~~(C)~~

FOR THE INFORMATION OF SAN JUAN AND OTHER RECEIVING OFFICES

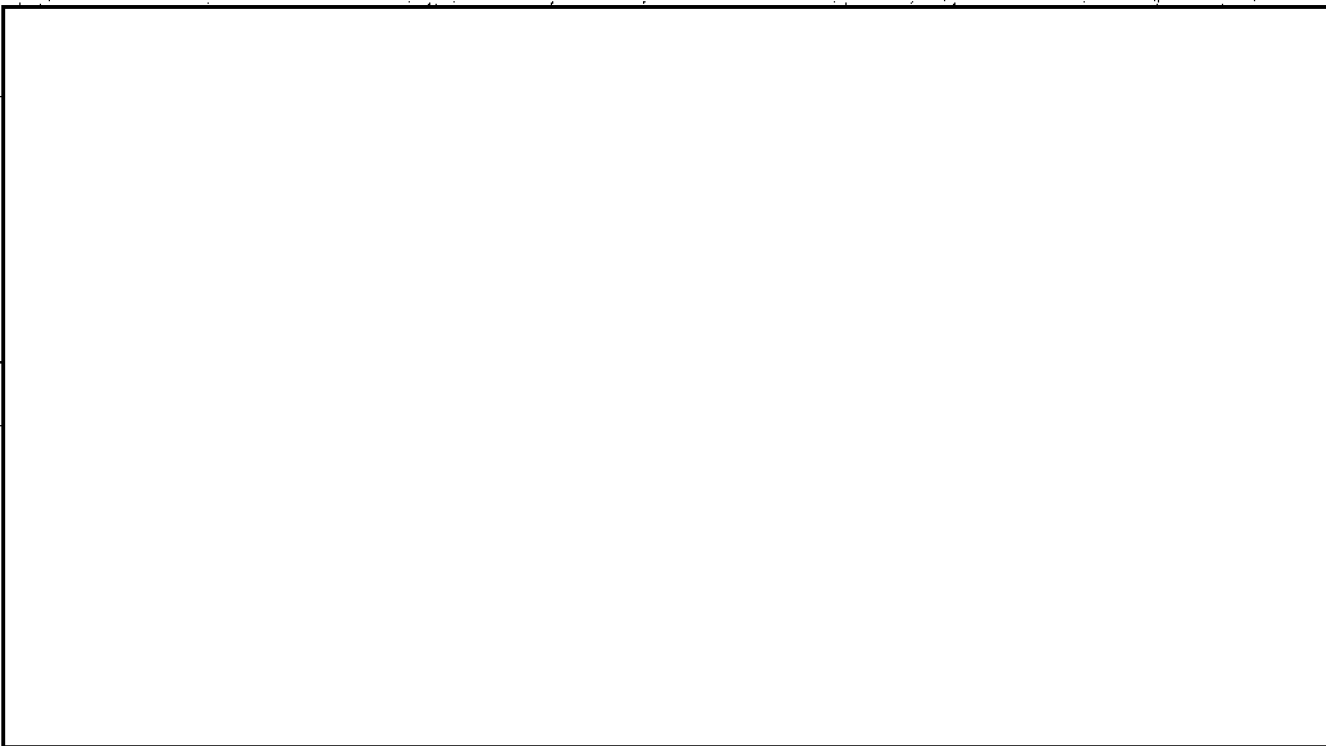

b6
b7C
b7D

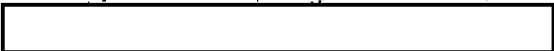

~~(C)~~

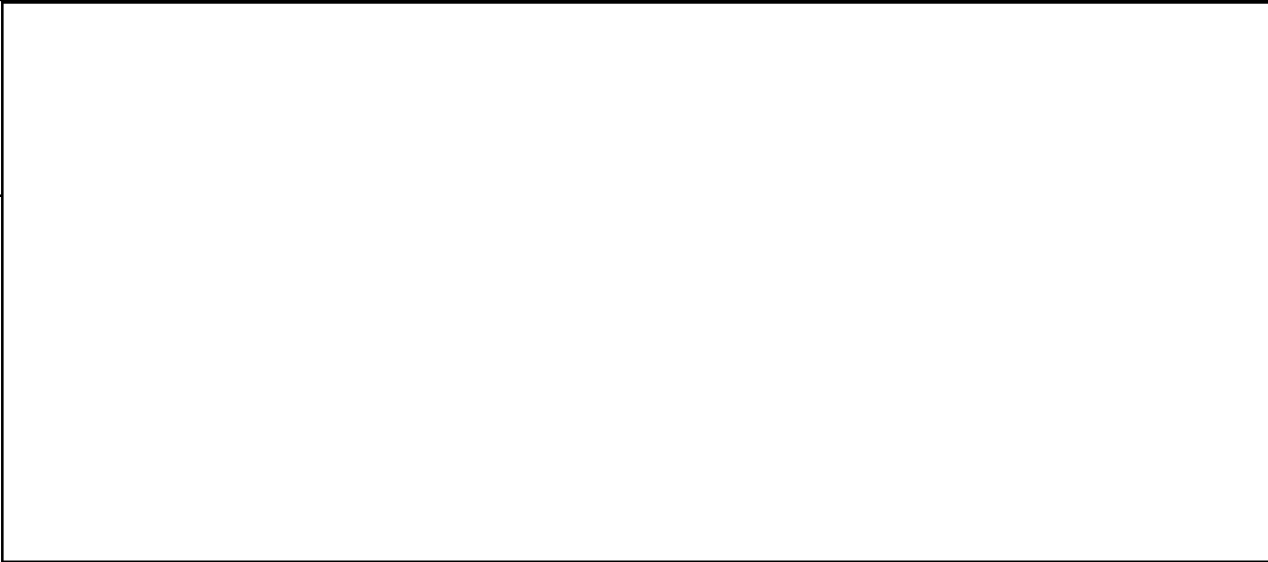

b6
b7C
b7D



~~(S)~~ (U)

[REDACTED] FURNISHED THIS INFORMATION AS A MATTER OF INFORMATION TO THE BUREAU, AND REQUESTED THAT THE BUREAU KEEP HIS IDENTITY AS A SOURCE OF THE INFORMATION CONFIDENTIAL. ~~(S)~~ (U)

b6
b7C
b7D

CHICAGO DIVISION IS FURNISHING THIS INFORMATION TO THE DIRECTOR, SAN JUAN, AND OTHER RECEIVING OFFICES FOR INFORMATION PURPOSES ONLY AT THIS TIME, AND NO FURTHER ACTION WILL BE TAKEN IN THE MATTER UNLESS REQUESTED BY THE DIRECTOR OR SAN JUAN. ~~(S)~~ (U)

~~C & F 1143, REASON 2 & 3, DRD OCTOBER 9, 1999.~~

BT

0J0300 2830352Z

RR HI CG LA MM NK NY SF WF

DE SJ

R 090353Z OCT 79

RECEIVED
TELETYPE UNIT

10 OCT 79

RECEIVED
FEDERAL BUREAU
OF INVESTIGATION
COMMUNICATIONS SECTION

Exec. AD-Inv.	_____
Exec. AD-Adm.	_____
Exec. AD-LES	_____
Asst. Dir.:	
Adm. Serv.	_____
Crim. Inv.	_____
Ident.	_____
Intell.	_____
Laboratory	_____
Legal Coun.	_____
Plan. & Insp.	_____
Rec. Mgnt.	_____
Tech. Serv.	_____
Training	_____
Public Affs. Off.	_____
Telephone Rm.	_____
Director's Sec'y	_____

b6
b7C

FM SAN JUAN (185-70) (P)

TO DIRECTOR ROUTINE

ATTN: CRIMINAL INVESTIGATION DIVISION AND INTELLIGENCE
DIVISION, CI-2 UNIT

CHICAGO ROUTINE

LOS ANGELES ROUTINE

MIAMI ROUTINE

NEWARK ROUTINE

NEW YORK ROUTINE

SAN FRANCISCO ROUTINE

WASHINGTON FIELD ROUTINE

BT

UNCLAS E F T O

CAZVIZ; PFO; (OO: NEW YORK)

REC-39
REC-39

185-1241-58

DE-31

REFERENCE BUREAU TELETYPE, DATED SEPTEMBER 2, 1979,
ENTITLED "PROPOSED VISIT OF CUBAN PREMIER FIDEL CASTRO"

b3
b6
b7C
b7E

OCT 15 1979

b6
b7C

1979

TELETYPE

TO:

b6
b7C

TO THE UNITED STATES, OCTOBER, 1979"; BUREAU TELETYPE,
DATED OCTOBER 8, 1979, ENTITLED "CAZVIZ"; SAN JUAN TELETYPE,
DATED OCTOBER 9, 1979, ENTITLED [REDACTED] CAZVIZ".

b3
b7E

ON OCTOBER 8-9, 1979, JOINT INTERVIEWS WERE CONDUCTED
BY FBI, SAN JUAN, AND U.S. SECRET SERVICE, SAN JUAN, OF
KNOWN ACTIVE AND INACTIVE ANTI-CASTRO CUBANS.

THE FOLLOWING ARE THOSE INDIVIDUALS WHICH HAVE BEEN
CONTACTED AND INTERVIEWED:

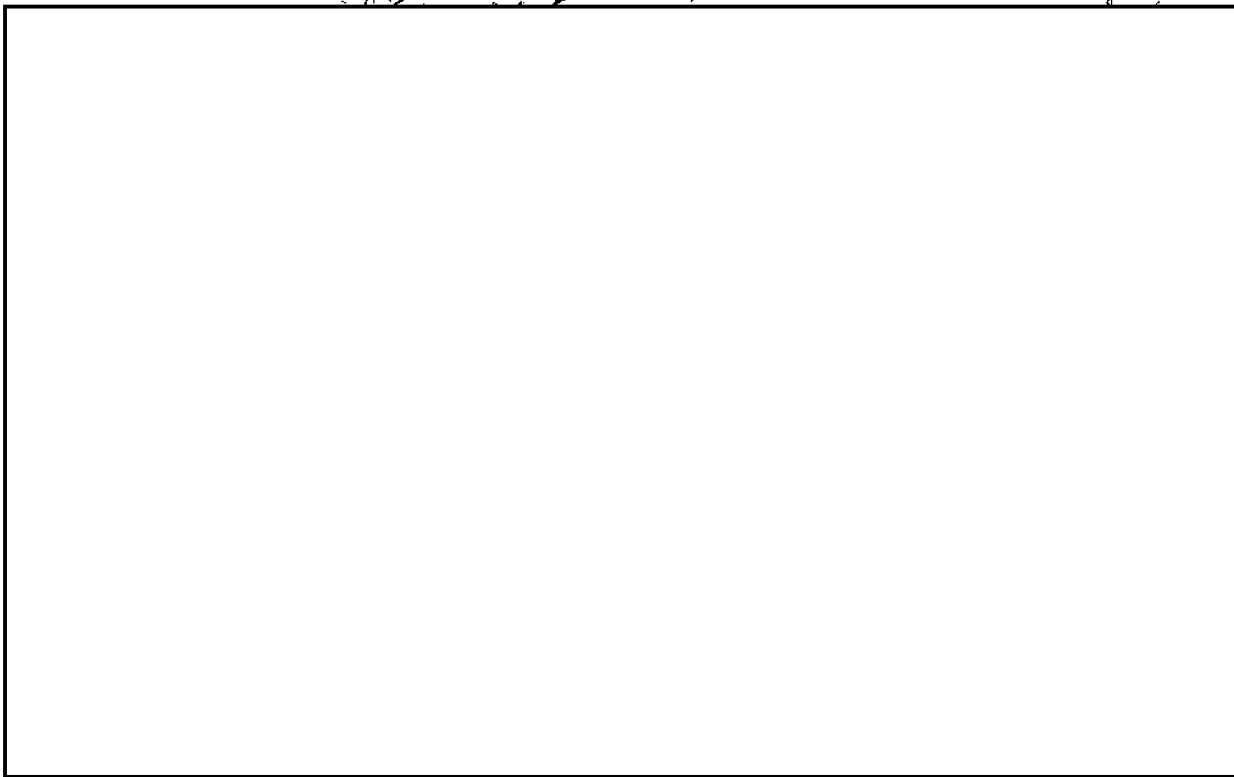

b6
b7C

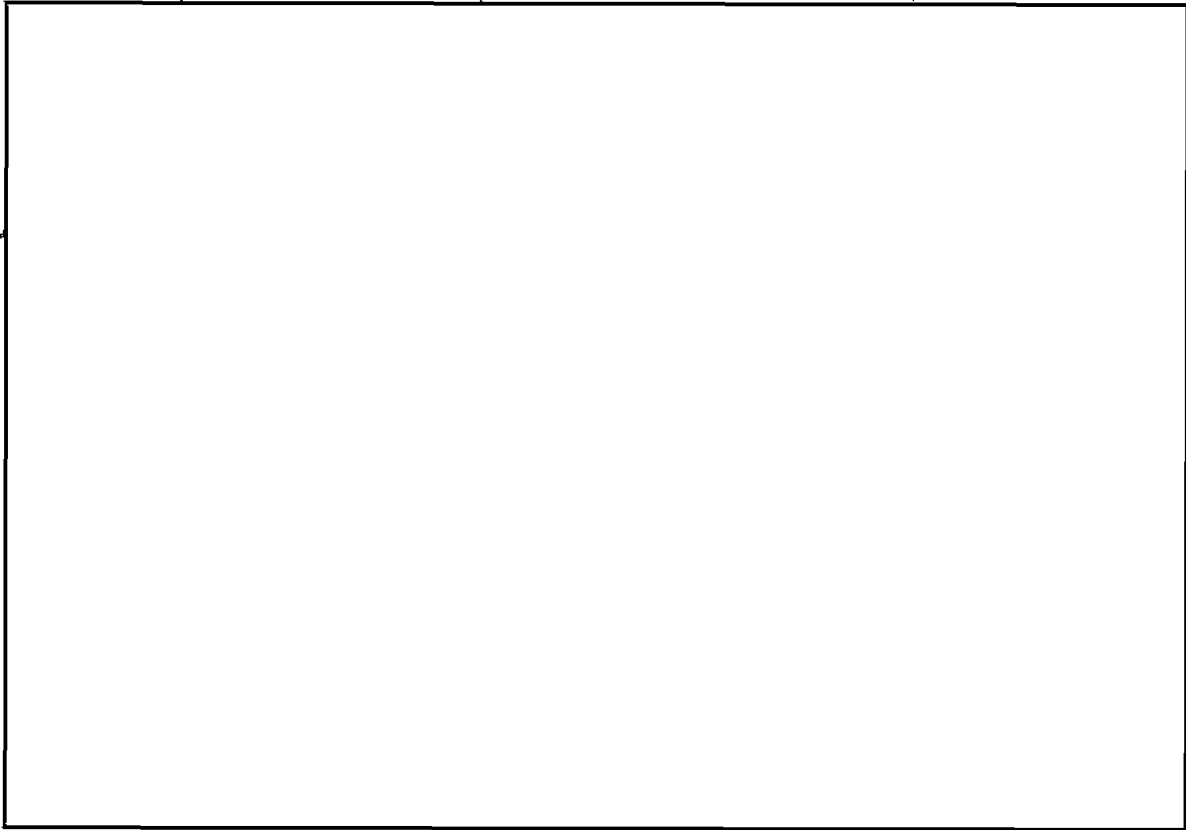

b6
b7c

ALL THE ABOVE DENIED BEING INVOLVED IN ANY PLANS OR
HAVING KNOWLEDGE OF ANY PLANS CONCERNING THE VISIT OF
FIDEL CASTRO TO THE UNITED STATES.

PAGE FOUR (185-70) UNCLAS E F T O

THE BELOW LISTED INDIVIDUALS HAVE NOT BEEN LOCATED
AND INTERVIEWED:

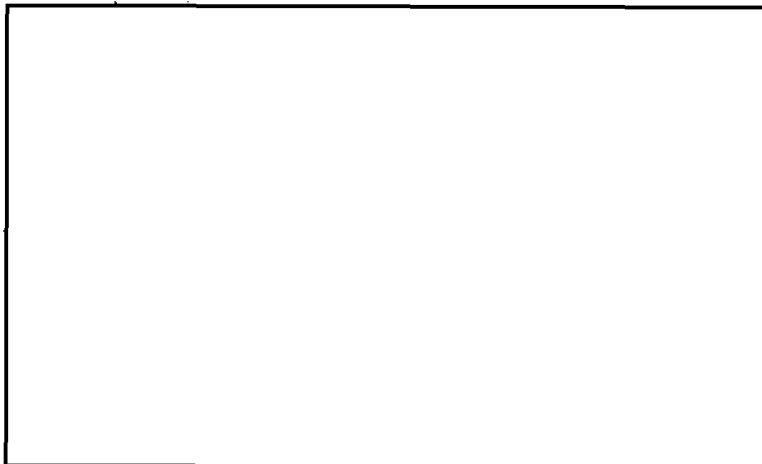

b6
b7c

SAN JUAN WILL CONTINUE IN ITS ATTEMPTS TO LOCATE AND
INTERVIEW ABOVE INDIVIDUALS WHO HAVE YET TO BE CONTACTED.

BT

cc - CI-2

#

SJ0290 2821715Z

OO HI MM NK NY SF WF

DE SJ 0002

O 091715Z OCT 79

FM SAN JUAN [redacted] (185-70)

TO DIRECTOR [redacted] IMMEDIATE

ATTN: INTELLIGENCE DIVISION, CI-2 UNIT; CRIMINAL
INVESTIGATIVE DIVISION

b3
b6
b7C
b7E

Exec AD-Adm.	
Exec AD-Inv.	
Exec AD-LES	
Asst. Dir.:	
Adm. Servs.	
Crim. Inv.	
Ident.	
Insp.	
Intell.	
Lab.	
Legal Coun.	
Plan. & Insp.	
Rec. Mgmt.	
Tech. Servs.	
Training	
Public Affs. Off.	
Telephone Rm.	
Director's Sec'y	

MIAMI PRIORITY
NEWARK ROUTINE
NEW YORK IMMEDIATE
SAN FRANCISCO ROUTINE
WASHINGTON FIELD ROUTINE

BT

~~SECRET~~ (U)

[redacted] (OO: SAN JUAN)

b3
b7E

CAZVIZ; PFO, (OO: NEW YORK)

REFERENCE SAN JUAN TELETYPE, SEPTEMBER 17, 1979, ENTITLED

[redacted] NO COPY
TO SAN FRANCISCO AND WASHINGTON FIELD; BUREAU TELETYPE,
OCTOBER 8, 1979, CAPTIONED "CAZVIZ".

185-1241-
[redacted]

NOT RECORDED
10 OCT 17 1979

b3
b6
b7C
b7E

ORIGINAL FILED IN

TELETYPE
[redacted]

97 OCT 17 1979

[redacted] PROX
OCT 16 1979

PAGE TWO [] (185-70) ~~SECRET~~

THIS TELETYPE IS CLASSIFIED "~~SECRET~~" IN ITS ENTIRETY.

ON OCTOBER 5, 1979, [] ADVISED []

[]

[]

b3
b6
b7C
b7D
b7E

b3
b6
b7C
b7D

[REDACTED]

[REDACTED]

ON THE MORNING OF OCTOBER 9, 1979, THE ASSET WAS
INTERVIEWED BY REPRESENTATIVES OF THE FBI [REDACTED]

b3
b6
b7C
b7D
b7E

[REDACTED]

FOLLOWING THE INTERVIEW OF THE ASSET, HE WILL ATTEMPT

[REDACTED]

b3
b6
b7C
b7D
b7E

SAN JUAN POINTS OUT THAT [REDACTED]

[REDACTED]

b3
b7D
b7E



b3
b6
b7C
b7D
b7E

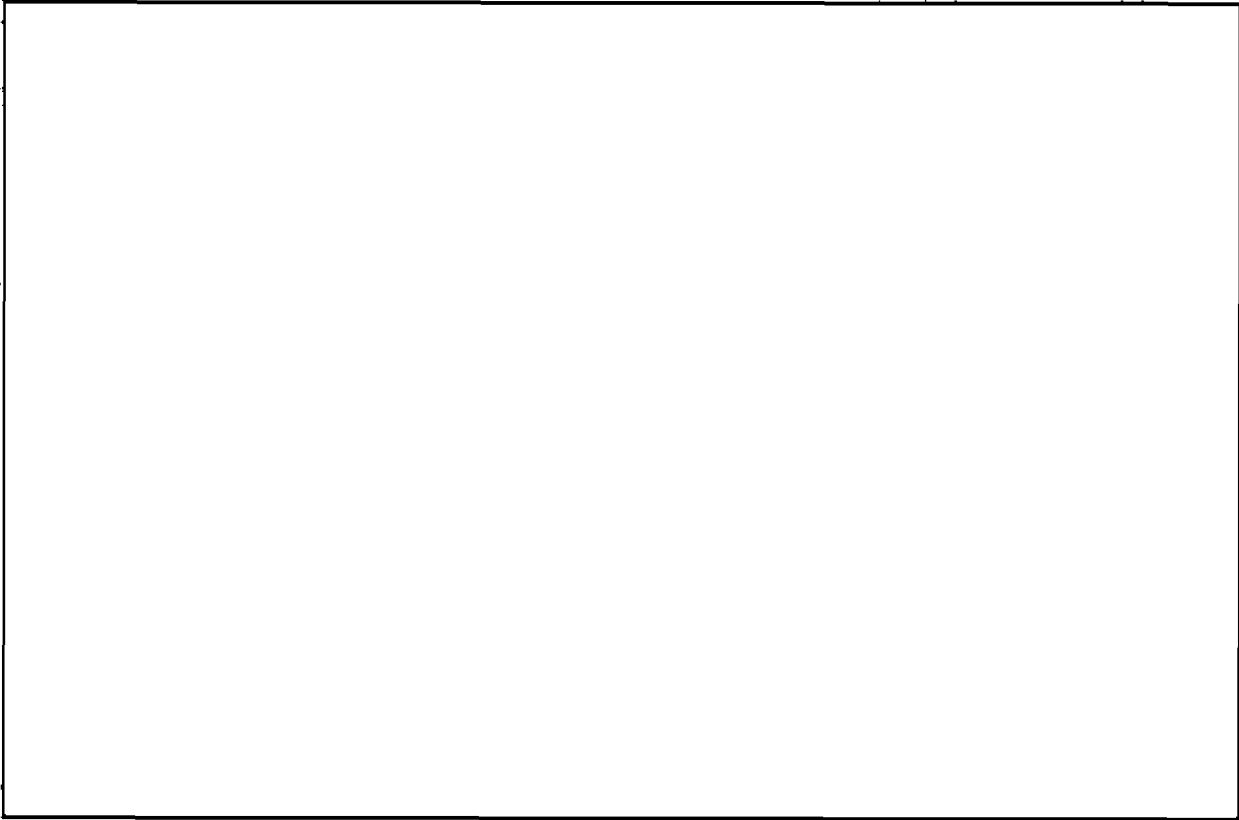

RECOMMENDATIONS REGARDING APPROPRIATE ACTION FOR THE



b3
b6
b7C
b7D
b7E

FOR THE INFORMATION OF RECIPIENTS, JOINT FBI - U.S. SECRET SERVICE INTERVIEWS OF KNOWN ANTI-CASTRO TERRORISTS RESIDING IN PUERTO RICO BEGAN ON OCTOBER 8, 1979. RESULTS OF THESE INTERVIEWS WILL BE SET FORTH IN A SUBSEQUENT COMMUNICATION.

~~C AND E, 8024, REASONS (2) AND (3), DRD OCTOBER 9, 1999.~~

BT

accid

b6
b7c

RECEIVED
TELETYPE UNIT

10 OCT 79 00 55Z

FEDERAL BUREAU
OF INVESTIGATION
COMMUNICATIONS SECTION

Exec AD-Adm.	_____
Exec AD-LES	_____
Asst. Dir.:	
Adm. Serv.	_____
Crim. Inv.	_____
Ident.	_____
Insp.	_____
Intell.	_____
Lab.	_____
Legal Coun.	_____
Plan. & Insp.	_____
Rec. Mgmt.	_____
Tech. Servs.	_____
Training	_____
Public Affs. Off.	_____
Telephone Rm.	_____
Director's Sec'y	_____

NY0213 2830053

PP HQ

DE NY 0035

P090042Z OCT 7

FM NEW YORK [redacted] (# 44)

TO DIRECTOR PRIORITY

BT

~~CONFIDENTIAL~~

VISIT OF FIDEL CASTRO IN CONNECTION WITH THE UNITED NATIONS

GENERAL ASSEMBLY, OCTOBER, 1979; [redacted]

ON OCTOBER 8, 1979, A HIGHLY SENSITIVE CONFIDENTIAL

SOURCE WHO HAS FURNISHED RELIABLE INFORMATION AND IN THE PAST

ADVISED THAT [redacted]

[Large redacted block]

ADMINISTRATIVE:

REC-39
ST-118

DE 33 106

CONFIDENTIAL SOURCE IS [redacted]

185-1241-59

C AND E 3441, REASONS 2 AND 3, DRD OCTOBER 9, 1999.

b3
b6
b7C
b7D
b7E

BT

#

DE-17A

OCT 15 1979

64 NOV 1979

RECEIVED
TELETYPE UNIT

10 OCT 79 15 40 z

RECEIVED
FEDERAL BUREAU
OF INVESTIGATION
COMMUNICATIONS SECTION

Exec. AD-Inv.	_____
Exec. AD-Adm.	_____
Exec. AD-LES	_____
Asst. Dir.:	
Adm. Servs.	_____
Crim. Inv.	_____
Ident.	_____
Intell.	_____
Laboratory	_____
Legal Coun.	_____
Plan. & Insp.	_____
Rec. Mgmt.	_____
Tech. Servs.	_____
Training	_____
Public Affs. Off.	_____
Telephone Rm.	_____
Director's Sec'y	_____

MM0003 2831524Z

PP HI NY NK SJ WF LA CG SF

DE MM

P 101524Z OCT 79

FROM MIAMI (185-126) P

TO DIRECTOR PRIORITY

NEW YORK PRIORITY

NEWARK PRIORITY

SAN JUAN (VIA WASHINGTON) PRIORITY

WASHINGTON FIELD OFFICE PRIORITY

LOS ANGELES PRIORITY

CHICAGO PRIORITY

SAN FRANCISCO PRIORITY

BT

UNCLAS E F T O

CAZVIZ; PFO. OO: NEW YORK.

RE BUREAU TELETYPE, OCTOBER 8, 1979.

SET FORTH ARE REPLY COMMENTS OF MIAMI OFFICE REGARDING SUBJECT 15 1979

VARIOUS ITEMS FURNISHED BY

[Redacted]

[Redacted]

[Redacted]

[Redacted]

[Redacted]

[Redacted]

[Redacted]

[Redacted]

[Redacted]

b6
b7C

b3
b6
b7C
b7E

b6
b7C
b7E

b6
b7C

1 OCT

REC-81

EX-138

185-1241-60

PAGE FIVE MM 185-126 UNCLAS E F T O

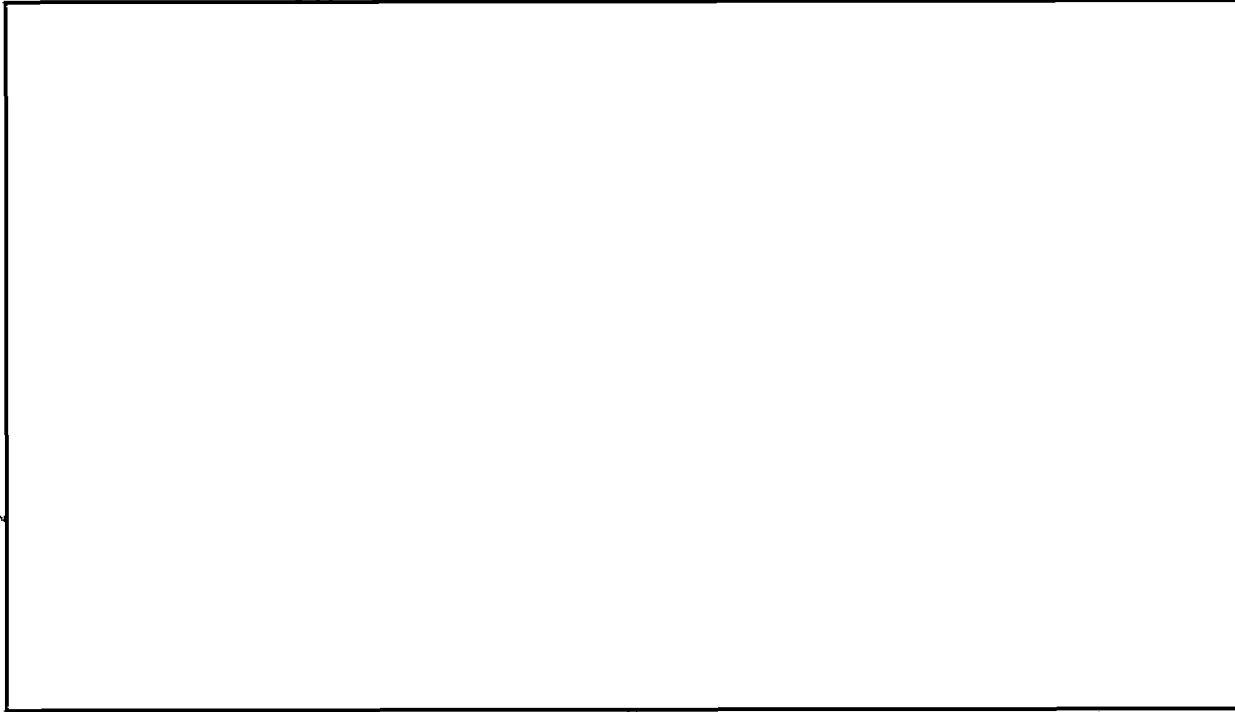

b6
b7C
b7E

MIAMI FBI WILL INTERVIEW PERSONS AS INDICATED ABOVE AND
FBIHQ AND RECEIVING OFFICES WILL BE ADVISED OF PERTINENT
DEVELOPMENTS.

BT

#

J

NY0232 2831643Z

OO HQ CG LA MM NK SF SJ WF

DE NY 0006

O 101630Z OCT 79

FM NEW YORK (185-899) (M-10)

TO DIRECTOR IMMEDIATE

CHICAGO ROUTINE

LOS ANGELES ROUTINE (VIA FBIHQ)

MIAMI PRIORITY

NEWARK IMMEDIATE

SAN FRANCISCO ROUTINE (VIA FBIHQ)

SAN JUAN ROUTINE (VIA FBIHQ)

WASHINGTON FIELD PRIORITY (VIA FBIHQ)

BT

RECEIVED TELETYPE UNIT

10 OCT 79 17 17Z

RECEIVED FEDERAL BUREAU OF INVESTIGATION COMMUNICATIONS SECTION

Exec AD Inv.	_____
Exec AD Adm.	_____
Exec AD Inv.	_____
Asst. Dir.:	
Adm. Servs.	_____
Crim. Inv.	_____
Ident.	_____
Intell.	_____
Laboratory	_____
Legal Coun.	_____
Plan. & Insp.	_____
Rec. Mgnt.	_____
Tech. Servs.	_____
Training	_____
Public Affs. Off.	_____
Telephone Rm.	_____
Director's Sec'y	_____

b6
b7c

SECRET

CAZVIZ; PROTECTION OF FOREIGN OFFICES OO: NEW YORK.

RENYTEL, DATED OCTOBER 9, 1979.

EX-100 REC-65

[redacted]

195-1241-61

b3
b6
b7C
b7D
b7E

ON OCTOBER 10, 1979, [redacted] ADVISED THAT [redacted]

5 OCT 15 1979

b6
b7c

NOV 8

MF

10/10 from Ron Hecks. USSS HQ. NY USSS advises USSS HQ by TT Daily of investigation and security.

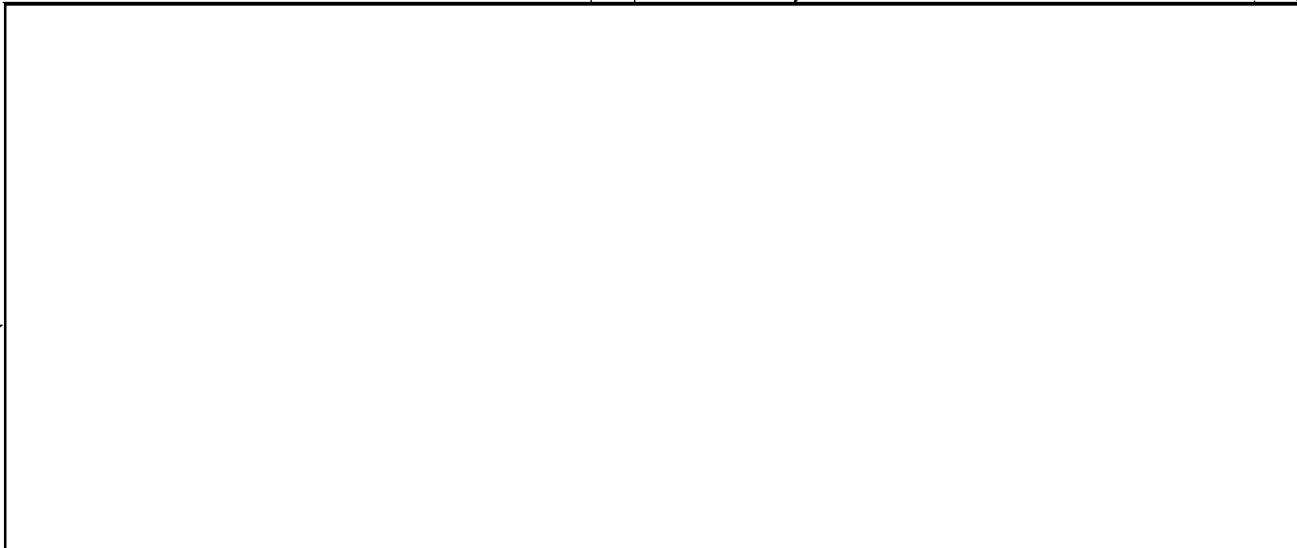

b6
b7C
b7D



HAS ADVISED THAT



b6
b7C
b7D

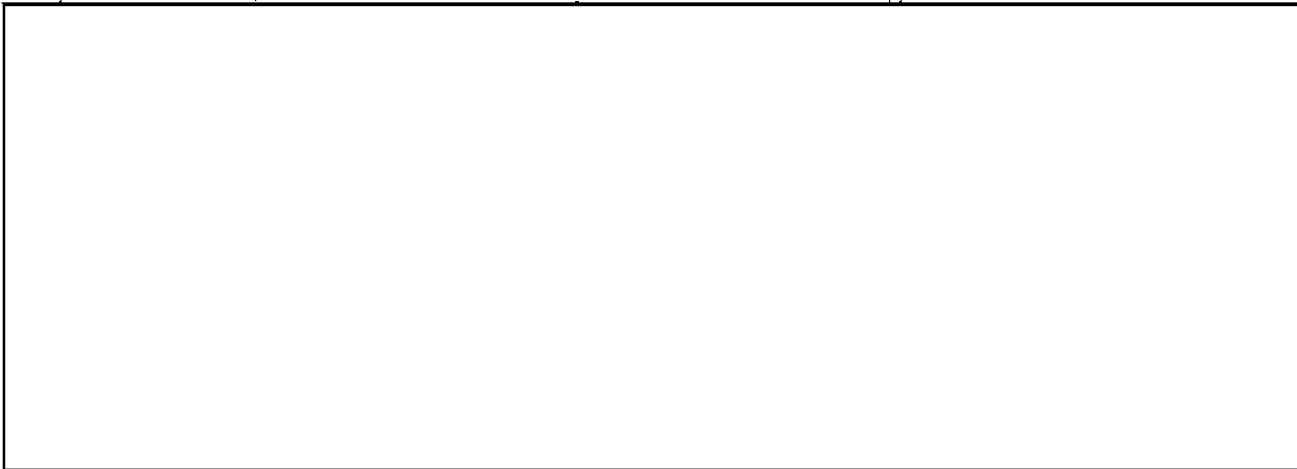

THIS INFORMATION BEING IMMEDIATELY DISSEMINATED TO NEW YORK

PAGE FIVE ~~SECRET~~

SECRET SERVICE, STATE DEPARTMENT, AND NYCPD, INTELLIGENCE DIVISION.

NEWARK WILL IMMEDIATELY ADVISE UNITED STATES SECRET SERVICE OF THIS INFORMATION.

ARMED AND DANGEROUS.

ADMINISTRATIVE

FOR THE INFORMATION OF THE BUREAU, [REDACTED]

b7D

[REDACTED] WHO IS NOW CLOSED AND NOT IN THIS AREA.

~~C&E 5815, REASON 2, DRD OCTOBER 10, 1999.~~

BT

#

RECEIVED
TELETYPE UNIT

b6
b7C

10 OCT 79 00 44z

RECEIVED
FEDERAL BUREAU
OF INVESTIGATION
COMMUNICATIONS SECTION

NY0211 2830026

PP HQ MM NK

DE NY 0026

P092328Z OCT 79 [redacted]

FM NEW YORK [redacted] (#44)

TO DIRECTOR PRIORITY

MIAMI PRIORITY

NEWARK PRIORITY

BT

~~SECRET~~

VISIT OF FIDEL CASTRO TO NEW YORK CITY - [redacted] 00:
NEW YORK.

ON OCTOBER 8, 1979, A SENSITIVE SOURCE WHO HAS FURNISHED
RELIABLE INFORMATION IN THE PAST ADVISED THAT [redacted]

[Large redacted block]

Exec AD-Adm.	
Exec AD-Inv.	
Exec AD-LES	
Asst. Dir.:	
Adm. Servs.	
Crim. Inv.	
Ident.	
Insp.	
Laboratory	
Legal Coun.	
Plan. & Insp.	
Rec. Mgnt.	
Tech. Servs.	
Training	
Public Affs. Off.	
Telephone Rm.	
Director's Sec'y	

b3
b6
b7C
b7E

b3
b6
b7C
b7E

DE-48

b3
b6
b7C
b7E

DE-48
REC-137

OCT 11 1979

b3
b6
b7C
b7E

[redacted]

FIVE

60
2 1979

Handwritten notes and markings on the right edge of the document, including a vertical stamp that reads "10/11/79" and other illegible scribbles.

[REDACTED]

b3
b7D

SOURCE ADVISED THAT

[REDACTED]

[REDACTED]

b3
b6
b7C
b7D

[REDACTED]

SENSITIVE SOURCE MENTIONED IS [REDACTED] AND CONFIDENTIAL
SOURCE MENTIONED IS [REDACTED]

b3
b7D
b7E

ABOVE BEING FURNISHED TO MIAMI AND NEWARK FOR INFORMATION
PURPOSES.

PAGE FOUR ~~SECRET~~

~~C AND E 3421, REASONS 2 AND 3, DRD OCTOBER 9, 1999.~~

BT

FEDERAL BUREAU OF INVESTIGATION
FOI/PA
DELETED PAGE INFORMATION SHEET
FOI/PA# 1362425-000

Total Deleted Page(s) = 78

Page 4 ~ Duplicate;
Page 15 ~ Duplicate;
Page 16 ~ Duplicate;
Page 19 ~ Duplicate;
Page 20 ~ Duplicate;
Page 24 ~ Duplicate;
Page 25 ~ Duplicate;
Page 26 ~ Duplicate;
Page 29 ~ Duplicate;
Page 30 ~ Duplicate;
Page 32 ~ b3; b6; b7C; b7E;
Page 33 ~ b3; b6; b7C; b7E;
Page 34 ~ b3; b6; b7C; b7E;
Page 35 ~ b3; b7E;
Page 36 ~ b3; b6; b7C; b7E;
Page 37 ~ b3; b6; b7C; b7E;
Page 38 ~ b3; b7E;
Page 39 ~ b3; b7E;
Page 40 ~ b3; b6; b7C; b7E;
Page 41 ~ Duplicate;
Page 42 ~ Duplicate;
Page 43 ~ Duplicate;
Page 44 ~ Duplicate;
Page 45 ~ Duplicate;
Page 46 ~ Duplicate;
Page 47 ~ Duplicate;
Page 48 ~ Duplicate;
Page 49 ~ Duplicate;
Page 51 ~ b3; b6; b7C; b7E;
Page 52 ~ b3; b6; b7C; b7E;
Page 53 ~ b3; b6; b7C; b7E;
Page 54 ~ Duplicate;
Page 55 ~ Duplicate;
Page 56 ~ Duplicate;
Page 57 ~ b3; b6; b7C; b7E;
Page 58 ~ Duplicate;
Page 60 ~ Duplicate;
Page 67 ~ b3; b6; b7C; b7E;
Page 70 ~ Duplicate;
Page 87 ~ b7E;
Page 88 ~ b7E;
Page 89 ~ b7E;
Page 91 ~ Duplicate;
Page 95 ~ b3; b6; b7C; b7E;
Page 96 ~ b3; b6; b7C; b7E;
Page 97 ~ b3; b6; b7C; b7E;
Page 98 ~ b3; b6; b7C; b7E;
Page 99 ~ b3; b6; b7C; b7E;
Page 100 ~ b3; b6; b7C; b7E;
Page 101 ~ b3; b6; b7C; b7E;
Page 102 ~ b3; b6; b7C; b7E;
Page 103 ~ b3; b6; b7C; b7E;
Page 104 ~ b3; b6; b7C; b7E;
Page 105 ~ b3; b6; b7C; b7E;
Page 106 ~ b3; b6; b7C; b7E;
Page 107 ~ b3; b6; b7C; b7E;
Page 108 ~ b3; b6; b7C; b7E;
Page 109 ~ b3; b6; b7C; b7E;
Page 110 ~ b3; b6; b7C; b7E;
Page 111 ~ b3; b6; b7C; b7E;
Page 112 ~ b3; b6; b7C; b7E;
Page 113 ~ b3; b6; b7C; b7E;
Page 114 ~ b3; b6; b7C; b7E;
Page 115 ~ b3; b6; b7C; b7E;
Page 116 ~ b3; b6; b7C; b7E;
Page 117 ~ b3; b6; b7C; b7E;
Page 118 ~ b3; b6; b7C; b7E;

Page 119 ~ b3; b6; b7C; b7E;
Page 120 ~ b3; b6; b7C; b7E;
Page 121 ~ b3; b6; b7C; b7E;
Page 122 ~ b3; b6; b7C; b7E;
Page 123 ~ b3; b6; b7C; b7E;
Page 124 ~ b3; b6; b7C; b7E;
Page 125 ~ b3; b6; b7C; b7E;
Page 126 ~ b3; b6; b7C; b7E;
Page 127 ~ b3; b6; b7C; b7E;
Page 128 ~ b3; b6; b7C; b7E;
Page 130 ~ Duplicate;

XXXXXXXXXXXXXXXXXXXXXXXXXXXXX
X Deleted Page(s) X
X No Duplication Fee X
X For this Page X
XXXXXXXXXXXXXXXXXXXXXXXXXXXXX

UNITED STATES GOVERNMENT

UNITED STATES DEPARTMENT OF JUSTICE
FEDERAL BUREAU OF INVESTIGATION

Memorandum

~~CONFIDENTIAL~~

TO : SAC, MIAMI [redacted]

DATE: 7/1/80

b3
b6
b7C
b7E

FROM : SA [redacted]

SUBJECT: PLOT TO ASSASSINATE CUBAN
PRESIDENT FIDEL CASTRO
DURING PLANNED VISIT TO NICARAGUA,
JULY, 1980

[redacted]
(OO: MIAMI)

b3
b7E

Re Miami teletype to Director dated 6/19/80, captioned
[redacted]

b3
b7E

By referenced communication the Miami Division advised the Bureau and other pertinent offices that information had been received from a confidential source that Cuban President FIDEL CASTRO would be the subject of an assassination attempt during his planned visit to Nicaragua. Some of the leaders of the operation involve Cuban-Americans from the Miami area. The source advised that [redacted]

b7D

[redacted]

The source advised he would attempt to obtain additional information regarding the alleged assassination plot.

In view of the above, it is recommended that a [redacted] case be opened and assigned.

b3
b7E

ADMINISTRATIVE

Confidential source mentioned above is [redacted]

b7D

(2) - [redacted]

[redacted] (2)

~~CONFIDENTIAL~~
Classified and Extended by 7796.
Reason for Extension: FCIM, II, 1-2.4.2
(2).
Date of Review for Declassification:
July 1, 2000.

Stamp: OPEN, CLASS, ORIGIN, PHA, DATE 7/2/80

Stamp: SEARCHED, SERIALIZED, INDEXED, JUL 1 1980

b3
b6
b7C
b7E



Date 7-11-80

Title and Character of Case

Plot to assassinate Cuban President Fidel Castro
During Visit to Nicaragua, July, 1980

b3
b7E

Date Property Acquired
7-9-80

Source From Which Property Acquired
S.A. []

Location of Property or Bulky Exhibit

Bulky Exhibit Room

A1

Reason for Retention of Property and Efforts Made to Dispose of Same

Evidence

b6
b7C

To Be Returned

Yes No

Agent Submitting Property or Exhibit

S?A? []

Agent Assigned Case

Description of Property or Exhibit

[]

b6
b7C
b7E

SEMIANNUAL INVENTORY CERTIFICATION TO JUSTIFY RETENTION OF PROPERTY (Initial and Date)

Field File # []

OO: Miami

SEARCHED [] INDEXED []
SERIALIZED [] FILED []
AUG 2 1980

b3
b6
b7C
b7E

Date 7-11-80

Title and Character of Case

Plot to assassinate Cuban President Fidel Castro During His
Visit to Nicaragua, July, 1980

[Redacted]

b3
b7E

Date Property Acquired

7-7-80

Source From Which Property Acquired

SAs

[Redacted]

and

[Redacted]

Location of Property or Bulky Exhibit

Bulky Exhibit Room

A1

Reason for Retention of Property and Efforts Made to Dispose of Same

EVIDENCE

b6
b7C

To Be Returned

Yes No

Agent Submitting Property or Exhibit

SA

[Redacted]

Agent Assigned Case

[Redacted]

Description of Property or Exhibit

[Redacted]

b6
b7C
b7E

SEMIANNUAL INVENTORY CERTIFICATION TO JUSTIFY RETENTION OF PROPERTY (Initial and Date)

Field File #

[Redacted]

OO: Miami

SEARCHED [Redacted] INDEXED [Redacted]
SERIALIZED [Redacted] FILED [Redacted]

AUG 24 1980

[Redacted]

b3
b6
b7C
b7E

Date 7-11-80

Title and Character of Case

Plot to Assassinate Cuban President Fidel Castro during
Visit to Nicaragua, July, 1980

[Redacted]

b3
b7E

Date Property Acquired

7-8-80

Source From Which Property Acquired

SA [Redacted]

Location of Property or Bulky Exhibit

Bulky Exhibit Room

A1

Reason for Retention of Property and Efforts Made to Dispose of Same

Evidence

b6
b7C

To Be Returned

Yes No

Agent Submitting Property or Exhibit

SA [Redacted]

Agent Assigned Case

[Redacted]

Description of Property or Exhibit

[Redacted]

b6
b7C
b7E

SEMIANNUAL INVENTORY CERTIFICATION TO JUSTIFY RETENTION OF PROPERTY (Initial and Date)

Field File #

[Redacted]

OO: Miami

SEARCHED [Redacted] INDEXED [Redacted]
SERIALIZED [Redacted] FILED [Redacted]

AUG 24 1980

b3
b6
b7C
b7E

Date 7-11-80

Title and Character of Case

Plot to assassinate Cuban President Fidel Castro During Visit
to Nicaragua, July, 1980

[Redacted]

b3
b7E

Date Property Acquired

7-9-80

Source From Which Property Acquired

SA [Redacted]

Location of Property or Bulky Exhibit

Bulky Exhibit Room

AI

Reason for Retention of Property and Efforts Made to Dispose of Same

Evidence

b6
b7C

To Be Returned

Yes No

Agent Submitting Property or Exhibit

SA [Redacted]

Agent Assigned Case

[Redacted]

Description of Property or Exhibit

[Redacted]

b6
b7C
b7E

SEMIANNUAL INVENTORY CERTIFICATION TO JUSTIFY RETENTION OF PROPERTY (Initial and Date)

Field File #

[Redacted]

OO:

Miami

SEARCHED	INDEXED
SERIALIZED	FILED
AUG 2 1980	
FBI-MIAMI	

b3
b6
b7C
b7E

FBI

TRANSMIT VIA:

- Teletype
- Facsimile
- _____

PRECEDENCE:

- Immediate
- Priority
- Routine

CLASSIFICATION:

- TOP SECRET
- SECRET
- ~~CONFIDENTIAL~~
- UNCLAS E F T O
- UNCLAS

5-30/P

Date JULY 1, 1980

FM MIAMI [redacted] [redacted] 42/P

TO DIRECTOR PRIORITY [redacted] 42/P

CHICAGO PRIORITY [redacted] 1158/P

LOS ANGELES PRIORITY [redacted] 856/P

NEWARK PRIORITY [redacted] 806/P

NEW YORK PRIORITY [redacted] 85/P

SAN JUAN (VIA BUREAU) PRIORITY [redacted] 642/P VIA FBIHQ

WASHINGTON FIELD PRIORITY [redacted] 533/P

BT

~~CONFIDENTIAL~~

PLOT TO ASSASSINATE CUBAN PRESIDENT FIDEL CASTRO DURING HIS PLANNED VISIT TO NICARAGUA, JULY, 1980; [redacted]

[redacted]; OO: MIAMI.

REFERENCE MIAMI TELETYPE TO BUREAU, JUNE 19, 1980, CAPTIONED

[redacted]

A CONFIDENTIAL SOURCE, WHO HAS PROVIDED RELIABLE INFORMATION IN THE PAST, ADVISED ON JULY 1, 1980, [redacted]

SEARCHED [redacted]
 INDEXED [redacted]
 SERIALIZED [redacted]
 FILED [redacted]

1 - Miami
(1) [redacted]

Approved: [Signature]

Transmitted 019 (Number) (Time)

Per [redacted]

b3 b7E

b6 b7C

b3 b7E

b3 b7E

b7D

b3 b6 b7C b7E

FBI

TRANSMIT VIA:

- Teletype
- Facsimile
- _____

PRECEDENCE:

- Immediate
- Priority
- Routine

CLASSIFICATION:

- TOP SECRET
- SECRET
- CONFIDENTIAL
- UNCLAS E F T O
- UNCLAS

Date _____

PAGE TWO

[Redacted]

~~C O N F I D E N T I A L~~

[Large Redacted Area]

[Redacted]

~~(S)~~ (U)

ADMINISTRATIVE:

SOURCE MENTIONED ABOVE IS [Redacted] WHO HAS NOT BEEN ABLE TO VERIFY AUTHENTICITY OF THE ABOVE INFORMATION. BUREAU AND PERTINENT WILL BE KEPT ADVISED OF ADDITIONAL INFORMATION AS IT IS DEVELOPED. ~~(S)~~ (U)

~~C&E BY 7796, REASONS 2 AND 3, DRD JULY 1, 2000.~~

BT

#

Approved: _____ Transmitted _____ (Number) (Time) Per _____

b3
b7E

b6
b7C
b7D

b7D

FBI

6:00/p

TRANSMIT VIA:

- Teletype
- Facsimile
- _____

PRECEDENCE:

- Immediate
- Priority
- Routine

CLASSIFICATION:

- TOP SECRET
- SECRET
- ~~CONFIDENTIAL~~
- UNCLAS E F T O
- UNCLAS

Date July 7, 1980

FROM MIAMI [redacted] P
 TO DIRECTOR, FBI (IMMEDIATE) 7:10/p [redacted]
 NEWARK (ROUTINE) 10:49/p [redacted]
 NEW YORK (ROUTINE) 7:45/p [redacted]

b3
b6
b7C
b7E

BT

~~CONFIDENTIAL~~

ATTENTION: BUREAU SUPERVISOR [redacted] TERRORISM SECTION, CID.
 PLOT TO ASSASSINATE CUBAN PRESIDENT FIDEL CASTRO DURING PLANNED
 VISIT TO NICARAGUA, JULY, 1980; [redacted]
 OO: MIAMI.

b3
b6
b7C
b7E

AUTHORITY IS REQUESTED TO UTILIZE AN ELECTRONIC DEVICE TO
 MONITOR AND/OR RECORD [redacted]

[redacted] IN CONNECTION WITH A PLOT TO KILL
 FIDEL CASTRO -- [redacted]

b3
b6
b7C
b7E

MIAMI HAS BEEN ATTEMPTING TO [redacted]

[redacted]

(1) - Miami

[redacted]
 (1) [redacted]

Form 0-1
 Date Received 7/10/80
 Date Returned 7/11/80
 Report By 7/25/80

SEARCHED.....
 INDEXED.....
 SERIALIZED.....
 FILED.....

b3
b6
b7C
b7E

Approved: AFN [redacted]

Transmitted 010 (Number) 7:40 (Time)

Per [redacted]

FBI

TRANSMIT VIA:

- Teletype
- Facsimile
- _____

PRECEDENCE:

- Immediate
- Priority
- Routine

CLASSIFICATION:

- TOP SECRET
- SECRET
- CONFIDENTIAL
- UNCLAS E F T O
- UNCLAS

Date _____

PAGE TWO

[Redacted]

~~C O N F I D E N T I A L~~

[Redacted]

AUTHORITY IS REQUESTED FOR USE OF

[Redacted]

[Redacted]

~~C & E BY 7796, REASONS 2 & 3, DRD JULY 7, 2000.~~

ADMINISTRATIVE.

RE MIAMI TELL CALL TO FBIHQ, JULY 3, 1980.

[Redacted]

TO BE UTILIZED IN THIS MATTER ARE

[Redacted]

[Redacted]

BT

#

b3
b6
b7C
b7D
b7E

b5
b6
b7C
b7E

b6
b7C

b6
b7C
b7E

Approved: _____

Transmitted _____
(Number) (Time)

Per _____

BY: [redacted]

b6
b7C

FBI

TRANSMIT VIA:

- Teletype
- Facsimile
- _____

PRECEDENCE:

- Immediate
- Priority
- Routine

CLASSIFICATION:

- TOP SECRET
- SECRET
- CONFIDENTIAL
- UNCLAS E F T O
- UNCLAS

5:00/P

Date JULY 9, 1980

FM MIAMI [redacted] P
 TO DIRECTOR IMMEDIATE ^{HI} 5:00/P [redacted]
 CHICAGO ROUTINE ^{8:45/A} [redacted]
 LOS ANGELES ROUTINE ^{7:45/A} [redacted]
 NEWARK ROUTINE ^{8:46/A} [redacted]
 NEW YORK ROUTINE ^{9:50/P} [redacted]
 SAN JUAN ROUTINE ^{5:07/P} [redacted]
 WASHINGTON FIELD ROUTINE ^{6:07/P} [redacted]
 BT

b3
b7E

b6
b7C

~~CONFIDENTIAL~~

ATTENTION: BUREAU SUPERVISOR [redacted] CRIMINAL
 INVESTIGATIVE DIVISION.

b6
b7C

PLOT TO ASSASSINATE CUBAN PRESIDENT FIDEL CASTRO DURING HIS
 PLANNED VISIT TO NICARAGUA, JULY, 1980; [redacted]

b3
b7E

[redacted] OO: MIAMI.

RE MIAMI TELEPHONE CALL TO BUREAU SUPERVISOR [redacted]

[redacted] ON JULY 8, 1980, AND MIAMI TELETYPE TO BUREAU DATED JULY

b6
b7C

(1) - Miami [redacted]
 (1) [redacted]

SEARCHED.....
 INDEXED.....
 SERIALIZED...
 FILED.....

b3
b6
b7C
b7E

Approved: AFN [redacted] Transmitted 016 [redacted] Per [redacted]
 (Number) (Time)

FBI

TRANSMIT VIA:

- Teletype
- Facsimile
- _____

PRECEDENCE:

- Immediate
- Priority
- Routine

CLASSIFICATION:

- TOP SECRET
- SECRET
- CONFIDENTIAL
- UNCLAS E F T O
- UNCLAS

Date _____

PAGE TWO ~~C O N F I D E N T I A L~~

1, 1980.

ON JULY 8, 1980, A CONFIDENTIAL SOURCE WHO HAS PROVIDED RELIABLE INFORMATION IN THE PAST ADVISED OF THE FOLLOWING:

THE SOURCE HAS LEARNED THAT ^{SEVERAL} FEDERAL COSTA RICAN CITIZENS ARE INVOLVED IN THE PLOT TO ELIMINATE FIDEL CASTRO WHEN HE VISITS NICARAGUA, SOMETIME DURING JULY, 1980.

~~(S)~~ (U)

SOURCE ADVISED THAT IN ADDITION TO THE INVOLVEMENT OF COSTA RICAN CITIZENS, SEVERAL WEALTHY CUBAN EXILES, WHO RESIDE IN COSTA RICA, ARE ALSO PARTICIPATING IN THE CONSPIRACY TO ASSASSINATE CASTRO.

~~(S)~~ (U)

THE SOURCE ADVISED THAT

Approved: _____

Transmitted _____ (Number) (Time)

Per _____

b3
b7E

b6
b7C

b6
b7C
b7D

b6
b7C
b7D

b6
b7C
b7D

FBI

TRANSMIT VIA:

- Teletype
- Facsimile
- _____

PRECEDENCE:

- Immediate
- Priority
- Routine

CLASSIFICATION:

- TOP SECRET
- SECRET
- CONFIDENTIAL
- UNCLAS E F T O
- UNCLAS

Date _____

PAGE THREE

[Redacted]

~~C O N F I D E N T I A L~~

[Large Redacted Area]

[Redacted]

~~(C)~~ (U)

~~C AND E BY 7796, REASONS 2 AND 3, DRD JULY 9, 2000.~~

ADMINISTRATIVE

ADMINISTRATIVE

SOURCE MENTIONED ABOVE IS [Redacted] WHO HAS NOT BEEN ABLE TO VERIFY THE AUTHENTICITY OF THE ABOVE INFORMATION.

BT

b3
b7E

b6
b7C
b7D

b7D

Approved: _____ Transmitted _____ Per _____

(Number) (Time)

FBI

7/9/80

TRANSMIT VIA:

- Teletype
- Facsimile
- _____

PRECEDENCE:

- Immediate
- Priority
- Routine

CLASSIFICATION:

- TOP SECRET
- SECRET
- CONFIDENTIAL
- UNCLAS E F T O
- UNCLAS

Date 7/9/80

FM MIAMI [redacted] (P)
 TO DIRECTOR PRIORITY ^{HT} 844/p [redacted]
 NEWARK ROUTINE 85/A [redacted]
 NEW YORK ROUTINE 95/A [redacted]
 BT

b3
b6
b7C
b7E

~~CONFIDENTIAL~~

ATTENTION BUREAU SUPERVISOR [redacted] TERRORISM SECTION, CID.

b3
b6
b7C
b7E

PLOT TO ASSASSINATE CUBAN PRESIDENT FIDEL CASTRO DURING PLANNED VISIT TO NICARAGUA, JULY, 1980; [redacted]

OO: MIAMI.

RE MM TEL TO BU DATED JULY 7, 1980.

PURSUANT TO EMERGENCY AUTHORITY GRANTED ON JULY 7, 1980, BY
 FBI SUPERVISOR [redacted] DUE TO THE EXIGENT CIRCUMSTANCES OF THIS
 CASE, [redacted]

b6
b7C
b7E

① - Miami
 [redacted]
 (1) [redacted]

SEARCHED... [redacted]
 INDEXED... [redacted]
 SERIALIZED... [redacted]
 FILED... [redacted]

Approved: [Signature]

Transmitted 019 (Number) (Time)

Per [redacted]

b3
b6
b7C
b7E

FBI

TRANSMIT VIA:

- Teletype
- Facsimile
- _____

PRECEDENCE:

- Immediate
- Priority
- Routine

CLASSIFICATION:

- TOP SECRET
- SECRET
- CONFIDENTIAL
- UNCLAS E F T O
- UNCLAS

Date _____

PAGE TWO

[Redacted]

~~C O N F I D E N T I A L~~

NO INFORMATION OF ANY VALUE WAS OBTAINED

[Redacted]

[Redacted]

[Redacted]

AUSA

[Redacted]

HAS BEEN ADVISED OF

[Redacted]

[Redacted]

IN VIEW OF THE ABOVE MIAMI WILL

DISCONTINUE THIS ASPECT OF CAPTIONED INVESTIGATION.

C AND E BY 7796, REASONS 2 AND 3, DRD JULY 9, 2000.

BT

b3
b6
b7C
b7E

Approved: _____

Transmitted _____

Per _____

(Number) (Time)

Memorandum

TO : SAC, MIAMI [redacted] (P)

DATE: 7/10/80

FROM : SA [redacted]

SUBJECT: PLOT TO ASSASSINATE CUBAN
PRESIDENT FIDEL CASTRO DURING
PLANNED VISIT TO NICARAGUA,
JULY, 1980.

[redacted]
(OO: MIAMI)

For the information of receiving agents, the Miami Division has received information from one of its confidential sources that Cuban President FIDEL CASTRO may be the victim of an assassination plot when he visits Nicaragua sometime during July, 1980. CASTRO is expected to attend the celebrations of the Sandinista takeover of Nicaragua.

In addition, the Bureau has received information concerning the possible visit to Nicaragua by [redacted]. He is expected to be present in Nicaragua on 7/18/80, and take part in the Sandinista Revolution festivities.

Receiving agents are requested to immediately contact sources re any information concerning captioned matter and furnish positive results to SA [redacted]

① - [redacted]

- 1 - Each #9 Squad Agent
- 1 - Each #10 Squad Agent
- 1 - Each #11 Squad Agent

Det.

[redacted] (33) [redacted] [redacted]

[redacted]
SEARCHED [redacted] INDEXED [redacted]
SERIALIZED [redacted] FILED [redacted]
JUL 10 1980
[redacted]



b3
b6
b7C
b7E

b3
b7E

b6
b7C

b6
b7C

b3
b7E

b3
b6
b7C
b7E

FEDERAL BUREAU OF INVESTIGATION

Date of transcription 7/15/80

1

On July 3, 1980, a confidential source (protect per request) who has furnished reliable information in the past, requested that the information he is furnishing not be disseminated outside of the FBI

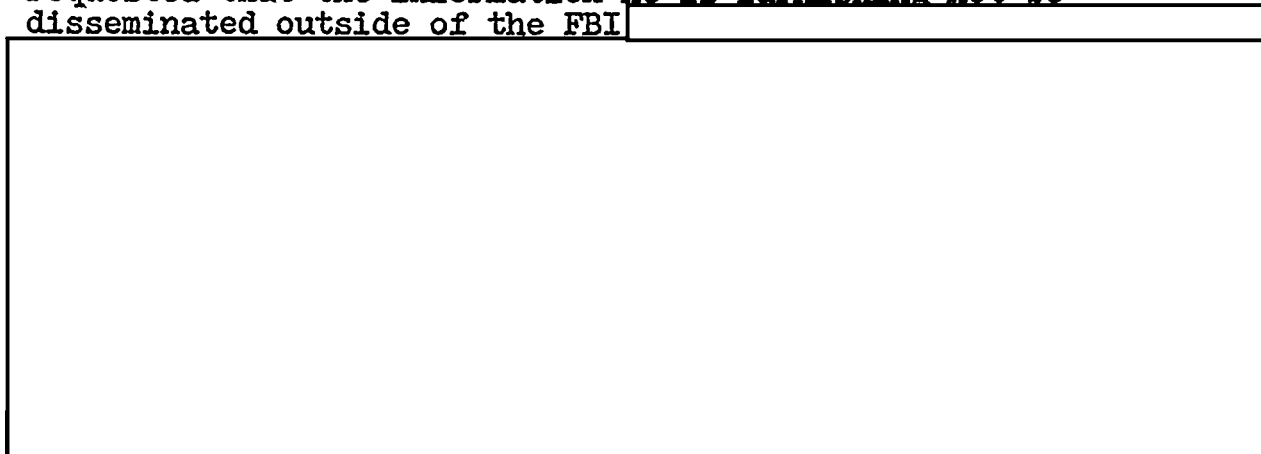

b6
b7C
b7D

Investigation on 7/3/80 at Miami, Florida File # 

by SA  Date dictated 7/9/80

b3
b6
b7C
b7E

Memorandum

TO : SAC, Miami

DATE: 7/22/80

b3
b7E

FROM : Director, FBI

SUBJECT: PLOT TO ASSASSINATE CUBAN
PRESIDENT FIDEL CASTRO
DURING PLANNED VISIT TO
NICARAGUA, JULY, 1980

b3
b7E

Reference Miami teletype to Bureau dated 7/4/80.

On 7/11/80, Gerald Shur, Associate Director, Office of Enforcement Operations, Department of Justice (DOJ), authorized use of a body recorder and transmitter in the matter for a period of 30 days. As you are aware, this equipment is only to be used when a consenting party is present. This also confirms FBHIQ emergency authority for use of this device previously granted.

Within 45 days, you are requested to advise FBIHQ whether the body recorder and transmitter:

1. Aided in directing course of investigation.
2. Obtained direct evidence.
3. Was used - no information of value gained.
4. Furnished lead material.
5. Gave protection to Agent or person wearing recorder.
6. Was not used.

Furthermore, in those instances when identity of a nonconsenting party was not known at time of request, an LHM should be forwarded to Bureau within 30 days following termination of monitoring which will identify nonconsenting party.

Miami should ensure that all persons identified as having been monitored, are suitably included in the field office and FBIHQ ELSUR indices, commensurate with existing instructions as outlined in Bureau airtels to all offices dated April 12, 1977, June 8, 1977, and October 21, 1977, entitled, "Microphone and Telephone Surveillances." Strictly administrative controls must be established to insure these requirements are met.

SEARCHED	INDEXED
SERIALIZED	FILED

JUL 24 1980

b3
b6
b7C
b7E

Memorandum

TO : SAC, MIAMI [redacted] (P)

DATE: 7/23/80

FROM : SA [redacted]

b3
b6
b7C
b7E

SUBJECT: PLOT TO ASSASSINATE CUBAN PRESIDENT
FIDEL CASTRO DURING HIS PLANNED
VISIT TO NICARAGUA, JULY, 1980.

[redacted]

(OO: MIAMI)

On 7/11/80, [redacted] (protect) advised that

[Large redacted block]

b6
b7C
b7D

The above was disseminated to ATF ASAC [redacted]
by Supervisor [redacted] on 7/14/80.

b6
b7C

① - [redacted]

[redacted]
(1) [redacted]

b3
b6
b7C
b7E

SEARCHED INDEXED
SERIALIZED FILED
JUL 24 1980





UNITED STATES DEPARTMENT OF JUSTICE
FEDERAL BUREAU OF INVESTIGATION

In Reply, Please Refer to
File No. [redacted]

Miami, Florida
July 23, 1980

b3
b7E

~~CONFIDENTIAL~~

RE: PLOT TO ASSASSINATE CUBAN PRESIDENT
FIDEL CASTRO DURING PLANNED VISIT
TO NICARAGUA, JULY, 1980.

On June 19, 1980, MM T-1 advised that he has learned from Cuban exiles who are active in Miami's Cuban community that Cuban-Americans from the Miami, Florida area have met and discussed the possibility of conducting an attack against the life of Fidel Castro when he visits Nicaragua, Central America. Castro is expected to be in Nicaragua sometime during July, 1980, and attend the anniversary celebrations of the Sandinista takeover. MM T-1 advised that Nicaraguan citizens may take part in the aforementioned assault. (S) (U)

b6
b7C
b7D

On June 20, 1980, MM T-2 advised that [redacted]

[redacted]

(S) (U)

On July 1, 1980, MM T-1 advised he has learned that

[redacted]

b6
b7C
b7D

(S) (U)

On July 8, 1980, MM T-1 advised that [redacted]

[redacted]

b6
b7C
b7D

This document contains neither recommendations nor conclusions of the FBI. It is the property of the FBI and is loaned to your agency; it and its contents are not to be distributed outside your agency.

SEARCHED....
INDEXED....
SERIALIZED...
FILED.....

b3
b6
b7C
b7E

RE: PLOT TO ASSASSINATE CUBAN
PRESIDENT FIDEL CASTRO
DURING PLANNED VISIT TO
NICARAGUA, JULY, 1980.

~~CONFIDENTIAL~~

[REDACTED]
[REDACTED] (S) (U)

MM T-1 further advised that [REDACTED]

[REDACTED] (S) (U)

On June 24, 1980, MM T-3 and MM T-4 advised [REDACTED]

[REDACTED]

[REDACTED] (S) (U)

On July 8, 1980, MM T-3 and MM T-4 advised that [REDACTED]

[REDACTED] (S) (U)

b6
b7C
b7D

b6
b7C
b7D
b7E

b6
b7C
b7D
b7E

- 2* -

~~CONFIDENTIAL~~

FBI

TRANSMIT VIA:

- Teletype
- Facsimile
- AIRTEL

PRECEDENCE:

- Immediate
- Priority
- Routine

CLASSIFICATION:

- TOP SECRET
- SECRET
- CONFIDENTIAL
- UNCLAS E F T O
- UNCLAS

Date 7/23/80

~~CONFIDENTIAL~~

TO: DIRECTOR, FBI

FROM: SAC, MIAMI [redacted] (P)

SUBJECT: PLOT TO ASSASSINATE CUBAN PRESIDENT
FIDEL CASTRO DURING PLANNED VISIT
TO NICARAGUA. JULY. 1980.

[redacted]
(OO: MIAMI)

b3
b7E

Re Miami teletype to Bureau dated 2/13/80, captioned

[redacted]
Miami teletype to Bureau dated 6/19/80, captioned [redacted]
[redacted] San Juan teletype to Bureau
dated 6/24/80, captioned [redacted]
Miami teletypes to Bureau dated 7/1/80 and 7/9/80, captioned "Plot
to Assassinate Cuban President Fidel Castro During Planned Visit
to Nicaragua, July, 1980, [redacted]."

b3
b6
b7C
b7E

Enclosed for the Bureau are 6 copies of an LHM, dated and captioned as above. Enclosed for informational purposes of receiving offices is one copy of above LHM.

~~CONFIDENTIAL~~

Classified & Extended by 7796.
Reason for Extension: FCIM, II, 1-2.4.2(2).
Date of Review for Declassification:
July 23, 2000.

Form 0-1

Date Received 9/4/80

Date Returned 9/5/80

Classified By 9/30/80

Status of investigation

- 2 - Bureau (Enc. 6) (RM)
- 1 - Chicago (Enc. 1) (Info) (RM)
- 1 - Newark (Enc. 1) (Info) (RM)
- 1 - New Orleans [redacted] (Enc. 1) (Info) (RM)
- 1 - New York (Enc. 1) (Info) (RM)
- 1 - San Juan (Enc. 1) (Info) (RM)
- 1 - WFO (Enc. 1) (Info) (RM)
- ② - Miami (1 - [redacted])
(1 - [redacted])

SEARCHED. [redacted] ...
INDEXED.. [redacted] ...
SERIALIZED [redacted] ...
FILED..... [redacted] ...

b3
b6
b7C
b7E

(10)

Approved: [redacted]

Transmitted _____

(Number) (Time)

Per _____

[Redacted]

~~CONFIDENTIAL~~

b3
b7E

MM T-1 is [Redacted]
MM T-2 is [Redacted]

MM T-3 is [Redacted]

b3
b6
b7C
b7D
b7E

MM T-4 is [Redacted]

ADMINISTRATIVE

It should be noted that pursuant to emergency authority granted on 7/7/80, by FBI Supervisor [Redacted] due to exigent circumstances, [Redacted]

[Redacted] Miami Division, [Redacted]

[Redacted]

[Redacted] No information was developed during the monitoring which appeared to be suitable for dissemination and therefore it has not been included in the enclosed LHM. (S) (U)

b6
b7C
b7E

~~CONFIDENTIAL~~

~~CONFIDENTIAL~~

b3
b6
b7C
b7E

On June 27, 1980, [redacted] advised that [redacted]

b7D

On July 8, 1980, [redacted] advised that [redacted]

b6
b7C
b7D

~~CONFIDENTIAL~~

~~Classified and Extended by 7796.
Reason for Extension: FCIM, II, 1-2.4.2(2).
Date of Review for Declassification:
July 10, 2000.~~

b3
b6
b7C
b7E

b6
b7C

[redacted]

~~CONFIDENTIAL~~

b3
b6
b7C
b7E

[redacted]
1

On September 30, 1980, [redacted] advised that [redacted]

[redacted]

b6
b7C
b7D

~~CONFIDENTIAL~~
~~Classified and Extended by 7796.~~
~~Reason for Extension: FCIM, II, 1-2.4.2(2).~~
~~Date of Review for Declassification:~~
~~September 30, 2000.~~

[redacted]

[redacted]

b3
b6
b7C
b7E

FBI

TRANSMIT VIA:

- Teletype
- Facsimile
- AIRTEL

PRECEDENCE:

- Immediate
- Priority
- Routine

CLASSIFICATION:

- TOP SECRET
- SECRET
- CONFIDENTIAL
- UNCLAS E F T O
- UNCLAS

Date 8/27/80

TO: SAC, MIAMI [redacted]

FROM: SAC, SAN JUAN [redacted] (RUC)

SUBJECT: PLOT TO ASSASSINATE CUBAN PRESIDENT
FIDEL CASTRO DURING PLANNED VISIT
TO NICARAGUA, JULY, 1980.
[redacted]

OO: MIAMI

b3
b7E

Reference Miami airtel with LHM to Director dated 7/23/80.

A review of San Juan file reveals no outstanding leads in this matter and as the visit of FIDEL CASTRO to Nicaragua has been accomplished without incident, the San Juan Division considers this case RUC.

② - Miami
1 - San Juan
[redacted]
(3)

[redacted]

SEARCHED INDEXED
SERIALIZED FILED
AUG 29 1980
FBI-MIAMI

[redacted]

b3
b6
b7C
b7E

Approved: [Signature] Transmitted _____ (Number) _____ (Time) Per _____

XX AIRTEL

9/25/80

~~CONFIDENTIAL~~

TO: DIRECTOR, FBI
FROM: SAC, MIAMI [redacted] (C)
SUBJECT: PLOT TO ASSASSINATE CUBAN PRESIDENT
FIDEL CASTRO DURING PLANNED VISIT
TO NICARAGUA, JULY, 1980.
[redacted]
(OO: MIAMI)

b3
b7E

Re Bureau letter dated 7/22/80, and Miami airtel to Bureau, dated 7/23/80.

Captioned investigation is predicated upon information received from [redacted] to the effect that Cuban President Fidel Castro would be the target of an assassination attempt during his visit to Nicaragua to attend the first anniversary celebration of the Sandinista takeover.

b7D

During the course of the above investigation, information was received from a confidential source who advised that [redacted]

[redacted]

b6
b7C
b7D

On 7/7/80, pursuant to emergency authority granted by FBIHQ Supervisor [redacted] due to the exigent circumstances of captioned case, [redacted]

[redacted]

b6
b7C
b7E

2 - Bureau (RM)
1 - Miami

[redacted] (3) [redacted]

[redacted]

4
5
6
[handwritten initials]

~~CONFIDENTIAL~~
Classified and Extended by 7796.
Reason for Extension: FCIM, II, 1-2.4.2(2).
Date of Review for Declassification:
September 25, 2000.

Searched _____
Serialized _____
Indexed _____
Filed _____

b3
b6
b7C
b7E

[redacted]

[redacted]

~~CONFIDENTIAL~~

b3
b7E

During the above monitoring no information of value was gained as a result of the recordings. No evidence was obtained and also no lead material was produced as a result of the aforementioned monitoring. [redacted]

b6
b7C
b7E

[redacted] AUSA [redacted] USA s office, Miami, Florida, has been kept informed of all relevant information pertaining to instant monitoring.

All relevant information developed during this investigation was reported to the Bureau and appropriate field offices in referenced Miami airtel. No additional pertinent information has been received by the Miami Division since the date of the above-mentioned communication. This case has been kept in pending status in order to report to the Bureau on any positive information developed by pertinent field offices during the course of the investigation.

In view of the fact that Fidel Castro s visit to Nicaragua took place without incident and no outstanding leads remain, this matter is being placed in closed status.

REQUEST OF THE BUREAU

It is requested that [redacted] who was consensually monitored on 7/7,8 & 9/80, be included in FBIHQ Elsur indices.

b6
b7C

~~CONFIDENTIAL~~

Memorandum

TO : SAC, MIAMI [redacted] (P)

DATE: 9/22/80

FROM : SA [redacted]

SUBJECT: PLOT TO ASSASSINATE CUBAN PRESIDENT
FIDEL CASTRO DURING PLANNED VISIT TO
NICARAGUA, JULY, 1980:

[redacted]

(OO: MIAMI)

b3
b6
b7C
b7E

Captioned investigative file was missing from around the beginning of July, 1980, until early September, 1980. The investigative file was placed on special search until it was located in September.

[redacted]

[redacted]

(1)

[redacted]

b3
b6
b7C
b7E

[redacted]	
SEARCHED	INDEXED
SERIALIZE	FILED
SEP 25 1980	
FBI-MAI	
[redacted]	[redacted]

b3
b6
b7C
b7E



Airtel

DATE: 10/6/80

To: SAC, Miami

PERSONAL ATTENTION

✓ From: Director, FBI

ELSUR

Reference MM airtel to Director dated 9/25/80 entitled "PLOT TO ASSASSINATE CUBAN PRESIDENT FIDEL CASTRO DURING PLANNED VISIT TO NICARAGUA, JULY, 1980, [redacted] (OO: MIAMI)," [redacted]

b3
b7E

Enclosed for MM are one copy each of Bureau airtels to all offices dated 4/12/77 and 6/8/77 entitled "MICROPHONE AND TELEPHONE SURVEILLANCES" and 12/6/78 entitled "ELECTRONIC SURVEILLANCE (ELSUR) MATTERS, ELSUR INDEX."

The enclosed Bureau airtels set forth current instructions on the preparation and submission of ELSUR cards. You are reminded that ELSUR cards are to be submitted by the Friday following the day an individual is first overheard or identified. They are to be submitted for all individuals who can be identified by a first and a last name, including cooperating witnesses, agents, informants, and assets. You are further reminded of the requirement to confirm a U. S. Attorney's opinion in writing if it is not given in writing.

By COB 10/21/80 MM is instructed to furnish appropriate Overhear cards in the referenced matter, or, if already done, the date of the airtel submitting same.

Enclosures (3)

[redacted]

SEARCHED	INDEXED
SERIALIZED	FILED
OCT 6 1980	

[redacted]

b3
b6
b7C
b7E

X AIRTEL

10/16/80

TO: DIRECTOR, FBI
(ATTN: ELSUR INDEX)
FROM: SAC, MIAMI (62-5710 Sub A)
SUBJECT: ELSUR MATTERS
ELSUR INDEX

Re Bureau airtel to Miami, 10/6/80.

Enclosed for the Bureau ELSUR Index are the following ELSUR overhear cards pertaining to Miami case captioned "PLOT TO ASSASSINATE CUBAN PRESIDENT FIDEL CASTRO DURING PLANNED VISIT TO NICARAGUA, JULY, 1980. [redacted] (OO: MIAMI)," [redacted]

[redacted]

b3
b6
b7C
b7E

2 - Bureau (Encls. 3)
② - Miami (1 - 62-5710 Sub A)

[redacted] [redacted]
[redacted] (4) [redacted] [redacted]

Searched _____
Serialized _____
Indexed _____
Filed _____

b3
b6
b7C
b7E

[redacted]

[Redacted]

Post Office Box 592418 AMF
Miami International Airport
Miami, Florida 33159
November 7, 1980

b3
b7E

Honorable Atlee W. Wampler, III
United States Attorney
Southern District of Florida
155 South Miami Avenue, 7th Floor
Miami, Florida 33130

b6
b7C

Attention: [Redacted]
Assistant U.S. Attorney

RE: PLOT TO ASSASSINATE CUBAN PRESIDENT FIDEL CASTRO
DURING PLANNED VISIT TO NICARAGUA, JULY, 1980;

[Redacted]

b3
b7E

Dear Sir:

This letter is to confirm a telephone conversation which took place on July 9, 1980, between Assistant U.S. Attorney (AUSA) [Redacted] and Special Agent (SA) [Redacted] of the Federal Bureau of Investigation (FBI).

b6
b7C

On July 7, 1980, AUSA [Redacted] was advised that [Redacted]

[Redacted]

b5
b6
b7C
b7E

On July 9, 1980, AUSA [Redacted] was advised by SA [Redacted] of the fact that the aforementioned monitoring had not produced any relevant information and for that reason it was discontinued. [Redacted] concurred with the above decision.

b6
b7C
b7E

Very truly yours,

ARTHUR F. NEHRBASS
Special Agent in Charge

2 - Addressee
① - Miami [Redacted]

By: [Redacted]
Supervisory Special Agent

[Redacted]
[Redacted] (3) [Redacted]

b3
b6
b7C
b7E

Searched [Redacted]
Serialized [Redacted]
Indexed [Redacted]
Filed [Redacted]

[Redacted]

[Redacted]

[Redacted]

[Redacted]

7/21/81

b3
b6
b7C
b7E

Material in this envelope has been masked pursuant to NARS appraisal of Field files and records mandated by Court Order 1/10/80. Civil Action 79-1655. The envelope is not to be removed without the authority of the Support Services Supervisor.

[Redacted]

7/21/81

[Redacted]

b6
b7C

UNITED STATES GOVERNMENT

UNITED STATES DEPARTMENT OF JUSTICE
FEDERAL BUREAU OF INVESTIGATION

Memorandum

~~CONFIDENTIAL~~

TO : SAC, MIAMI

DATE: 3/2/81

FROM : *JOE/SM* SAC, CHICAGO [redacted] (RUC)

b3
b7E

SUBJECT: PLOT TO ASSASSINATE ✓
CUBAN PRESIDENT FIDEL CASTRO - [redacted] (7/80)
DURING HIS PLANNED VISIT TO
NICARAGUA
JULY, 1980

b3
b7E

[redacted]

(OO: Miami)

Chicago has maintained contact with logical sources in the Chicago area most knowledgeable in anti-Castro activities with negative results.

~~(S)~~ (U)

Inasmuch as no information has been received since the investigation was initiated by Miami, Chicago is conducting no further investigation and is considering this matter RUC'd.

~~(S)~~ (U)

- ② - Miami (RM)
- 1 - Chicago

[redacted]

(3)

cl

[redacted]	
SEARCHED	INDEXED
SERIALIZED	[redacted]
MAR 5 1981	
[redacted]	

b3
b6
b7C
b7E

~~CONFIDENTIAL~~

~~Classified and Extended by 7107
Reason for Extension FCIM, II, 1-2.4.2 (2&3)
Date of Review for Declassification 3/2/2001~~

great!



Memorandum



To : SAC, MIAMI [redacted]

Date 6/10/82

From : SA [redacted]

Subject : ELSUR MATTERS

b3
b6
b7C
b7E

A review of the above file for the Elsur Indexing Project was completed by SA [redacted]. As a result of this review and all of the serials of the above file, it was noted various names to be indicated for Elsur. The Elsur clerk reviewed her cards and found out all these names had been indexed. As a result of all names been indexed, further review was unnecessary for this file at this time.

b6
b7C

① - [redacted]
1 - 62-5710
1 - Elsur Coordinator *Det.*

[redacted]

(3)

[redacted]

[redacted]

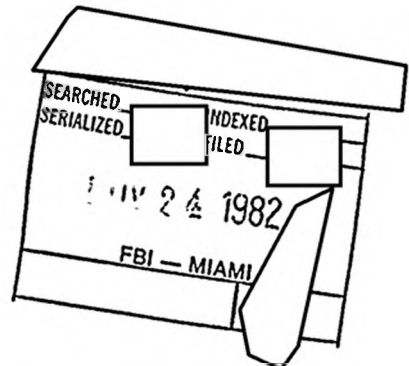

b3
b6
b7C
b7E

FEDERAL BUREAU OF INVESTIGATION
FOI/PA
DELETED PAGE INFORMATION SHEET
FOI/PA# 1362425-000

Total Deleted Page(s) = 64

- Page 17 ~ b7D;
- Page 18 ~ b7D; b7E;
- Page 29 ~ Duplicate;
- Page 31 ~ Duplicate;
- Page 32 ~ b3; b6; b7C; b7E;
- Page 34 ~ b3; b6; b7C; b7E;
- Page 35 ~ b3; b6; b7C; b7E;
- Page 40 ~ b3; b6; b7C; b7D; b7E;
- Page 41 ~ b3; b6; b7C; b7D; b7E;
- Page 42 ~ b3; b6; b7C; b7D; b7E;
- Page 43 ~ b3; b6; b7C; b7D; b7E;
- Page 44 ~ b3; b7D; b7E;
- Page 45 ~ b3; b6; b7C; b7D; b7E;
- Page 49 ~ b6; b7C; b7E;
- Page 71 ~ Duplicate;
- Page 73 ~ Duplicate;
- Page 84 ~ Duplicate;
- Page 86 ~ Duplicate;
- Page 87 ~ Duplicate;
- Page 88 ~ Duplicate;
- Page 89 ~ Duplicate;
- Page 90 ~ Duplicate;
- Page 94 ~ b6; b7C; b7D;
- Page 97 ~ b6; b7C;
- Page 99 ~ b6; b7C;
- Page 107 ~ b3; b7E;
- Page 108 ~ b3; b6; b7C; b7D; b7E;
- Page 109 ~ b3; b6; b7C; b7D; b7E;
- Page 110 ~ b3; b6; b7C; b7D; b7E;
- Page 111 ~ b3; b6; b7C; b7D; b7E;
- Page 112 ~ b3; b6; b7C; b7D; b7E;
- Page 113 ~ Duplicate;
- Page 114 ~ Duplicate;
- Page 115 ~ Duplicate;
- Page 116 ~ Duplicate;
- Page 117 ~ Duplicate;
- Page 118 ~ Duplicate;
- Page 120 ~ b6; b7C; b7D;
- Page 128 ~ b6; b7C; b7E;
- Page 129 ~ b6; b7C; b7E;
- Page 130 ~ b6; b7C; b7E;
- Page 134 ~ b6; b7C; b7E;
- Page 136 ~ b6; b7C; b7E;
- Page 137 ~ b6; b7C; b7E;
- Page 138 ~ b6; b7C; b7E;
- Page 139 ~ b6; b7C; b7E;
- Page 140 ~ b6; b7C; b7E;
- Page 141 ~ b6; b7C; b7E;
- Page 142 ~ b6; b7C; b7E;
- Page 143 ~ b6; b7C; b7E;
- Page 144 ~ b6; b7C; b7E;
- Page 145 ~ b7E;
- Page 153 ~ Duplicate;
- Page 155 ~ Duplicate;
- Page 156 ~ Duplicate;
- Page 157 ~ Duplicate;
- Page 158 ~ Duplicate;
- Page 159 ~ Duplicate;
- Page 160 ~ Duplicate;
- Page 161 ~ Duplicate;
- Page 162 ~ Duplicate;
- Page 181 ~ Duplicate;
- Page 188 ~ Duplicate;
- Page 189 ~ Duplicate;

X No Duplication Fee X
X For this Page X
XXXXXXXXXXXXXXXXXXXXXXXXXX

SF0775 2 830145Z

RR HQ MM NY SJ

DE SF 010

090114Z OCT 79

FM SAN FRANCISCO (185-250)

TO DIRECTOR, FBI (ROUTINE)

MIAMI (ROUTINE)

NEW YORK (ROUTINE)

SAN JUAN (ROUTINE) VIA FBIHQ

BT

UNCLAS

PROPOSED VISIT OF CUBAN PREMIER FIDEL CASTRO TO UNITED STATES, OCTOBER, 1979; PFO MATTER, OO: NEW YORK. REC 11

RE SF TELETYPE DATED OCTOBER 4, 1979, TO DIRECTOR, ET AL.

ON OCTOBER 9, 1979, [REDACTED] WAS INTERVIEWED

AT [REDACTED] AND PROVIDED THE

FOLLOWING INFORMATION:

ON SEPTEMBER 28, 1979 HE DID TRAVEL TO MIAMI, FLORIDA, AND STAYED THERE UNTIL APPROXIMATELY OCTOBER 2, 1979, AT WHICH TIME HE THEN TRAVELED TO NEW YORK CITY. [REDACTED] WAS MET AT THE AIRPORT BY ONE [REDACTED] WHO THEN TRANSPORTED HIM TO ANOTHER ADDRESS

RECEIVED TELETYPE UNIT

10 OCT 79 01 56z

RECEIVED FEDERAL BUREAU OF INVESTIGATION COMMUNICATIONS SECTION

Exec AD-Adm.	_____
Exec AD-Inv.	_____
Exec AD-LES	_____
Asst. Dir.:	
Adm. Serv.	_____
Ident.	_____
Laboratory	_____
Legal Coun.	_____
Plan. & Insp.	_____
Rec. Mgnt.	_____
Tech. Servs.	_____
Training	_____
Public Affs. Off.	_____
Telephone Rm.	_____
Director's Sec'y	_____

b6
b7C

b3
b6
b7C
b7E
11 OCT 12 1979

b6
b7C

b6
b7C

63 OCT 9 1979
TELE-TYPED

PAGE TWO SF 185-250 UNCLAS

WHICH IS CURRENTLY UNKNOWN. (IT IS BELIEVED TO BE THE ADDRESS WHERE HE WAS LOCATED BY NEW YORK AGENTS WHICH WAS THE RESIDENCE OF [REDACTED])

[REDACTED] STATED HIS SOLE PURPOSE OF TRAVELLING TO NEW YORK WAS TO ATTEND A DEMONSTRATION HELD ON OCTOBER 5, 1979, OUT IN FRONT OF THE UNITED NATIONS BUILDING IN NEW YORK. HE THEN LEFT NEW YORK ON OCTOBER 6, 1979, BY TWA FLIGHT 43 FROM JFK AIRPORT, WHICH LEFT JFK AT APPROXIMATELY 9:30 P.M. ON OCTOBER 6, 1979, ARRIVING AT SAN FRANCISCO INTERNATIONAL AIRPORT AT 1:30 A.M., OCTOBER 7, 1979.

b6
b7C

[REDACTED] ADVISED THAT HE WOULD LIKE TO RETURN TO NEW YORK FOR A DEMONSTRATION WHICH IS ANTICIPATED TO BE LARGER THAN THE ONE ON OCTOBER 5, 1979, WHICH IS TO BE HELD OCTOBER 12, 1979, AT THE SAME LOCATION.

b6
b7C

[REDACTED] ADVISED THAT HE WOULD IN FACT NOTIFY THE FBI PRIOR TO MAKING ANY TRAVEL PLANS AND HE WOULD ADVISE AS TO THE AIRLINE FLIGHT AND TIME OF ARRIVAL IN NEW YORK CITY.

b6
b7C

[REDACTED] STATED THAT HE DID NOT KNOW OF ANY PERSON WHO HAD ANY PLANS TO HARM THE LIFE OF FIDEL CASTRO UPON HIS VISIT TO THE UNITED STATES.

b6
b7C

THE ONLY THING HE KNOWS OF ARE DEMONSTRATIONS THAT WILL BE HELD IN THE NEW YORK AREA IN THE FORTHCOMING DAYS.

PAGE THREE SF 185-250 UNCLAS

ADMINISTRATIVE: IT IS THE OPINION OF SAN FRANCISCO THAT WILL IN FACT NOTIFY US OF HIS TRAVELS. IT SHOULD BE NOTED, HOWEVER, THAT HE IS STILL DEDICATED TO THE FACT OF THE OVERTHROW OF THE CASTRO GOVERNMENT AND IT IS NOT KNOWN AS TO HOW FAR HE WOULD CARRY THAT PARTICULAR ENDEAVOR.

b6
b7c

BT

Exec. AD-Adm.	b6
Exec. AD-Inv.	b7C
Exec. AD-LES	
Asst. Dir.:	
Adm.	
Crim.	
Ident.	
Intell.	
Laboratory	
Legal Coun.	
Plan. & Insp.	b6
Rec. Mgnt.	b7C
Tech. Servs.	
Training	
Public Affs. Off.	
Telephone Rm.	
Director's Sec'y	

RECEIVED TELETYPE UNIT

10 OCT 79 83 32z

RECEIVED
FEDERAL BUREAU
OF INVESTIGATION
COMMUNICATIONS SECTION

NY0216 2830301
 PP HQ CG LA MM NK SF HI
 DE NY 0036
 P090057Z OCT 79
 FM NEW YORK (185-899) (M-10)
 TO DIRECTOR PRIORITY
 CHICAGO PRIORITY
 LOS ANGELES PRIORITY
 MIAMI PRIORITY
 NEWARK PRIORITY
 SAN FRANCISCO PRIORITY
 SAN JUAN PRIORITY (VA FBIHQ)
 BT

~~SECRET~~

SECTION ONE OF THREE SECTIONS
 CAZVIZ; PFO; OO: NEW YORK.

REC 11
EX-109

185-1241-64

REFERENCE BUREAU TELETYPE, OCTOBER 8, 1979.

ON OCTOBER 7, 1979, UNITED STATES SECRET SERVICE (USSS)

NEW YORK CITY (NYC), RECEIVED [redacted]

11 OCT 12 1979

[redacted] AS WAS SET FORTH IN REFERENCED BUREAU TELETYPE.

ON OCTOBER 8, 1979, SPECIAL AGENTS (SAS), NYO, HELD A
 CONFERENCE WITH SAS, USSS AND DISCUSSED THE CONTENTS OF THIS

63
 1979
 TYPED TO:
 SJ

b3
b6
b7C
b7E

b6
b7C

DOCUMENT. THE FOLLOWING IS AN ASSESSMENT OF PORTIONS OF THE DOCUMENT. NEWARK, MIAMI, AND SAN JUAN WILL ALSO COMMENT ON ITEMS CONTAINED IN THE DOCUMENT RELATIVE TO INDIVIDUALS WITHIN THEIR RESPECTIVE DIVISIONS.

[REDACTED] ON OCTOBER 9, 1979, [REDACTED]

ADVISED THAT [REDACTED]

b6
b7C
b7D
b7E

[REDACTED] THE FOLLOWING INFORMATION AND ANALYSIS IS SET FORTH AS A RESULT OF CONTACT WITH [REDACTED] IT IS NOTED AT THIS POINT THAT

b7D
b7E

[REDACTED] THE IDENTITY OF THIS SOURCE IS KNOWN TO THE NEWARK DIVISION AND TO THE BUREAU SUPERVISOR WHO HANDLED

THE CASE ENTITLED "CHILBOM; PFO - MURDER; EID; OOJ; OO:
WASHINGTON FIELD".

ACCORDING TO

[REDACTED]

[REDACTED]

b6
b7C
b7D

IN LATE FALL, 1978,

[REDACTED]

[REDACTED]

[REDACTED]

NYO

b6
b7C
b7D

NOTES AT THIS POINT THAT [REDACTED]
[REDACTED]

[REDACTED] THE BUREAU WAS ADVISED OF
THIS MATTER [REDACTED]

[REDACTED]

[REDACTED] AT THE TIME NYO SOURCE [REDACTED]

[REDACTED]

IN ADDITION TO THE ABOVE, [REDACTED]

[REDACTED]

[REDACTED] HAS ADVISED THAT [REDACTED]

[REDACTED]

b7D
b7E

b6
b7C
b7D

b6
b7C
b7D

[REDACTED]

b7D

THE ABOVE SOURCE HAS ADVISED THAT UNDER NO CIRCUMSTANCES
WILL HE TESTIFY TO ANY OF THE ABOVE [REDACTED]

[REDACTED]

b6
b7C
b7D

SOURCE HAS ADVISED THAT [REDACTED]

[REDACTED]

b6
b7C
b7D

NYO SOURCE [REDACTED]

[REDACTED], BUT NYO NOTES AT THIS
TIME THAT SOURCE IS HIGHLY RELUCTANT TO DIVULGE THE NAMES
OF THESE ANTI-CASTRO CUBAN EXILES.

b7D

THE NYO RECOMMENDS TO NEWARK DIVISION THAT NO INVESTI-
GATION BE CONDUCTED RELATIVE TO PERSONS MENTIONED [REDACTED]

[REDACTED]

b7D
b7E

NYO217 2830315

PP HQ CG LA MM NK SF HI

DE NY 0037

P090104Z OCT 79

FM NEW YORK (185-899) (M-10)

TO DIRECTOR PRIORITY

CHICAGO PRIORITY

LOS ANGELES PRIORITY

MIAMI PRIORITY

NEWARK PRIORITY

SAN FRANCISCO PRIORITY

SAN JUAN PRIORITY (VIA FBIHQ)

BT

~~SECRET~~

SECTION TWO OF THREE SECTIONS

CAZVIZ; PFO; OO: NEW YORK.

[REDACTED]

[REDACTED]

SOURCE HAS ADVISED THAT

[REDACTED]

[REDACTED]

SOURCE HAS ADVISED THAT

[REDACTED]

b6
b7C
b7D

[REDACTED]

b6
b7C
b7D

RELATIVE TO [REDACTED] SOURCE HAS ADDED THAT [REDACTED]

[REDACTED]

b6
b7C
b7D

IT IS THE OPINION OF [REDACTED] THAT [REDACTED]

[REDACTED]

b6
b7C
b7D
b7E

REGARDING THE USE OF REMOTE CONTROL DEVICES IN ANY ATTEMPT ON FIDEL CASTRO, THE NYO NOTES THAT DURING THE INVESTIGATION OF THE CASE ENTITLED "CHILBOM" (MENTIONED ABOVE) IT WAS

DETERMINED THAT MEMBERS OF THE CUBAN NATIONALIST MOVEMENT PURCHASED A REMOTE CONTROL PAGING DEVICE FROM GRAND CENTRAL RADIO, NEW YORK CITY. THE ACTUAL PURCHASE CONSISTED OF A TRANSMITTER AND FOUR RECEIVERS AND THE INVESTIGATION, AND SUBSEQUENT TRIAL, REVEALED THAT THE TRANSMITTER IN THAT CASE AND TWO RECEIVING DEVICES HAVE NEVER BEEN RECOVERED. THE TRANSMITTER AND TWO RECEIVING DEVICES MAY STILL BE IN THE HANDS OF MEMBERS OF THE CUBAN NATIONALIST MOVEMENT. THIS INFORMATION HAS BEEN TRANSMITTED TO THE USSS AT NEW YORK IN ADDITION TO THE NYCPD BOMB SQUAD.

[REDACTED]

b7D

[REDACTED]

THIS OPINION AND ANALYSIS

HAS BEEN PROVIDED TO USSS AT NEW YORK AND HAS BEEN EXPLAINED TO THEM THAT IT IS ONLY A POSSIBILITY AND AN OPINION OF A HIGHLY RELIABLE SOURCE:

NYO SOURCE HAS ADVISED THAT

[REDACTED]

b7D

[REDACTED]

[REDACTED]

b7D

NYO NOTES AT THIS POINT THAT ABSOLUTELY NO INFORMATION
RELATIVE TO THE ACTIVITIES OF CASTRO, ARRIVAL, ETC., ARE BEING
PROVIDED TO ANY NYO SOURCES IN THE CUBAN EXILE FIELD.

SOURCE RELATED THAT

[REDACTED]

[REDACTED]

b7D

SOURCE STATED THAT

[REDACTED]

b7D

[REDACTED]

NYO218 2830328

PP HQ CG LA MM NK SF HI

DE NY 0038

P090112Z OCT 79

FM NEW YORK (185-899) (M-10)

TO DIRECTOR PRIORITY

CHICAGO PRIORITY

LOS ANGELES PRIORITY

MIAMI PRIORITY

NEWARK PRIORITY

SAN FRANCISCO PRIORITY

SAN JUAN PRIORITY (VIA FBIHQ)

BT

~~SECRET~~

FINAL SECTION OF THREE SECTIONS

CAZVIZ; PFO; OO: NEW YORK.



b3
b6
b7C
b7D
b7E

ADDITIONAL REFERENCE IS MADE TO CHICAGO TELETYPE, DATED
SEPTEMBER 18, 1979, CAPTIONED [REDACTED]

[REDACTED] WHICH CONCERNED A PLOT
AGAINST FIDEL CASTRO BY [REDACTED]
CHICAGO WILL ADVISE CURRENT STATUS OF THIS ALLEGED PLOT.

ADDITIONAL REFERENCES MADE TO LOS ANGELES TELETYPE,
DATED SEPTEMBER 18, 1979 AND NEW YORK TELETYPE, SAME DATE,
CAPTIONED "PROPOSED VISIT OF CUBAN PREMIER FIDEL CASTRO TO
THE UNITED STATES, OCTOBER 1979; PFO MATTER". LOS ANGELES
WILL CONTACT LOS ANGELES POLICE DEPARTMENT RELATIVE
TO ANY ADDITIONAL INFORMATION FROM THEIR SOURCE AND ADVISE
NEW YORK WHETHER OR NOT SOURCE WILL TRAVEL TO NEW YORK FOR
THE CASTRO VISIT.

OTHER RECIPIENTS WILL IMMEDIATELY CONTACT SOURCES RELATIVE
TO CAPTIONED.

~~C AND E 5815, REASON 2 AND 3, DRD OCTOBER 9, 1999.~~

BT

b3
b6
b7C
b7E

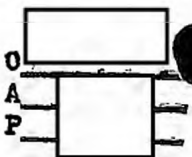

027

MESSAGE RELAY VIA TELETYPE

DATE 10/10/79	CLASSIFICATION UNCLAS E F T O	PRECEDENCE ROUTINE
------------------	----------------------------------	-----------------------

FM DIRECTOR FBI

TO

CAZVIZ

b3
b6
b7C
b7E

[Large redacted area]

[Redacted area]

185-124-65

(SERVICE ALSO AVAILABLE TO GOVERNMENT AGENCIES NOT LISTED -
CONTACT COMMUNICATIONS CENTER FOR ADDRESSING INFORMATION)

SUBJECT:

SEE ATTACHED

EX-138

~~_____~~
22 OCT 15 1979
~~_____~~

b3
b6
b7C
b7E

APPROVED BY: 	ORIGINATOR 	ROOM 5027	TELE EXT. 2805
--	--	--------------	-------------------

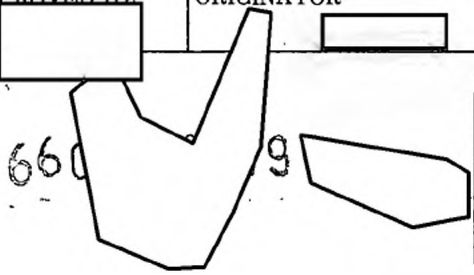
660 

FEDERAL BUREAU OF INVESTIGATION
 COMMUNICATIONS SECTION
1986E
 OCT 11 1979

b6
b7C

DO NOT FILE WITHOUT COMMUNICATIONS STAMP

USE OF FORM 0-73

1. Only incoming teletype messages which require transmission relay may be prepared for transmission using form 0-73. Use of form 0-73 is restricted to incoming teletype messages received within the last 3 days which require transmission relay; all other teletype messages must be prepared using form 0-93.
2. Additions such as notes and administrative data for a specific addressee are not allowed. If a note or administrative data is required for a particular addressee a separate 0-73 form must be prepared.
3. The message will be transmitted just as it appears. The person approving the message is solely responsible for assuring all necessary editing changes have been made.

PREPARATION OF FORM WHICH CONSISTS OF A PREPRINTED YELLOW.

1. Complete appropriate boxes: date, classification & precedence.
2. List addresses immediately following the "TO" or place a check mark in the appropriate boxes.
3. Type or PRINT the subject in the space provided.
4. Print or type originator's name, room number and telephone extension.
5. Indicate approval for transmission by initialing the "Approved By" box.

11 OCT 79 03 08
RECEIVED
FEDERAL BUREAU
OF INVESTIGATION
COMMUNICATIONS SECTION

PREPARATION OF MESSAGE TO BE TRANSMITTED

1. Xerox 1 copy of incoming teletype message. A notation shall be made on the original incoming teletype "1 copy made for relay to SACS _____, (OR LEGATS) _____, (OR GOVERNMENT AGENCIES) _____."
2. Minor editing changes shall be made on the xerox as follows: using a lead pencil ONLY draw single line through the first and last lines of the heading and connect these lines from top right to bottom left forming a "Z," figure. (DO NOT OBLITERATE THE HEADING.) Use horizontal lines to delete sentences or words. Printed changes of a word or two to the text of the message may be made; however, changes to the existing text involving more than a word or two necessitate the originator to initiate a new message using form 0-93.
3. Administrative data or notes may be typed immediately following the text and will be transmitted to all addressees.
4. When using the 0-73 form to disseminate information to field offices, Legal Attaches and other Government agencies simultaneously, the text, notes and administrative data must be identical for all addressees.

RECEIVED
TELETYPE UNIT

11 OCT 79 01 52z

RECEIVED
FEDERAL BUREAU
OF INVESTIGATION
COMMUNICATIONS SECTION

Exec. AD-Inv.	
Exec. AD-Adm.	
Exec. AD-LES	
Asst. Dir.:	
Adm. Serv.	
Crim. Inv.	
Ident.	
Intell.	
Laboratory	
Legal Coun.	
Plan. & Insp.	
Rec. Mgnt.	
Tech. Servs.	
Training	
Public Affs. Off.	
Telephone Rm.	
Director's Sec'y	

b6
b7C

NY0276 2840124

OO HQ MM NK HI WF

DE NY 0050

0100005Z OCT 79

FM NEW YORK (185-899) (M-10)

TO DIRECTOR IMMEDIATE

MIAMI PRIORITY

NEWARK PRIORITY

SAN JUAN PRIORITY (VIA FBIHQ)

WASHINGTON FIELD PRIORITY

BT

~~UNCLAS E F T O~~

CAZVIZ; PFO; OO: NEW YORK.

~~REFERENCES MADE TO NYO TELEPHONE CALL TO BUREAU, OCTOBER 10,~~

~~1979~~

BY TELETYPE 10/10/79 NEW YORK FURNISHED THE FOLLOWING:

FOR THE INFORMATION OF THE BUREAU LATEST AVAILABLE INDICATION IS THAT FIDEL CASTRO WILL ARRIVE APPROXIMATELY 2:00 AM, MORNING OF OCTOBER 11, 1979.

FOR THE INFORMATION OF THE BUREAU, CUBAN AMBASSADOR RESIDENCE IS LOCATED AT [REDACTED] AND UNITED STATES STATE DEPARTMENT AND NEW YORK CITY POLICE DEPARTMENT (NYCPD) PERSONNEL ARE MAINTAINING SECURITY AT

b6
b7C

TELETYPED TO:
85

PAGE TWO U N C L A S E F I O

THAT LOCATION.

ON SUNDAY, OCTOBER 7, 1979, INFORMATION WAS RECEIVED FROM A DOORMAN LOCATED AT [REDACTED] WHICH IS LOCATED APPROXIMATELY 40 YARDS AND ON THE SAME SIDE OF THE STREET AS CUBAN AMBASSADOR'S RESIDENCE. THIS INFORMATION IS AS FOLLOWS:

b6
b7C

DURING EVENING HOURS OF SUNDAY, OCTOBER 7, 1979, SEVERAL MEMBERS OF A CUBAN EXILE GROUP KNOWN AS ALPHA 66 ENTERED THE BUILDING AT [REDACTED] AND PROCEEDED TO [REDACTED] [REDACTED] TO VISIT ONE [REDACTED] DOORMAN NOTICES CUBAN EXILES WEARING LAPEL BUTTONS INDICATED ALPHA 66. DOORMAN STATED THAT THERE WAS ONE INDIVIDUAL, AN ELDERLY MAN, AND TWO WHITE FEMALES. DOORMAN STATED HE OVERHEARD THE NAME "NAZAR IO."

b6
b7C

ON EVE OF SUNDAY, OCTOBER 7, 1979, [REDACTED] INTERVIEWED WITH UNITED STATES STATE DEPARTMENT AT HIS RESIDENCE AND IT WAS DETERMINED AT THAT TIME THAT [REDACTED] IS ALLEGEDLY A REPORTER [REDACTED] [REDACTED] WHO WAS CASUAL, COOL AND COOPERATIVE INDICATED THAT KNOWS NASARIO SARGEN, CURRENT LEADER OF ALPHA 66 ANTI-CASTRO

b6
b7C

PAGE THREE U N C L A S E F T O

ORGANIZATION IN MIAMI, FOR MANY YEARS. [] STATED THAT SARGEN AND HIS TWO FEMALE ACQUAINTANCES WERE AT HIS RESIDENCE EVE OF OCTOBER 7, 1979, TO DISCUSS A STORY WHICH [] IS DOING RELATIVE TO MIAMI ANTI-CASTRO PERSONNEL.

b6
b7C

NYO NOTES THAT [] APARTMENT AT [] [] IS ON THE CORNER OF THE BUILDING, [] AND A PICTURE WINDOW IN [] LIVING ROOM WHICH CAN BE OPENED IS DIRECTLY LOOKING DOWN ON THE DOORWAY OF THE CUBAN AMBASSADOR'S RESIDENCE.

b6
b7C

THE BUREAU, MIAMI AND SAN JUAN ARE COGNIZANT OF AN ONGOING SITUATION RELATIVE TO ALPHA 66 LEADER, NASARIO SARGEN. DURING LATE AFTERNOON OF WEDNESDAY, OCTOBER 10, 1979,

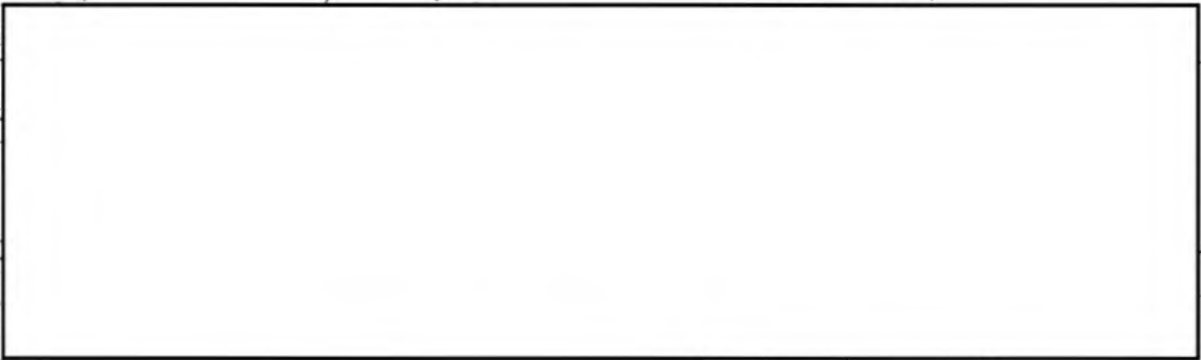

b6
b7C
b7E

[] UNITED STATES STATE DEPARTMENT SPECIAL AGENTS AND NYCPD PERSONNEL IMMEDIATELY

PAGE FOUR U N C L A S E F T O

RESPONDED. WHEREIN THEY ENTERED THE RESIDENCE OF ONE [REDACTED]

b6
b7C

[REDACTED]
[REDACTED] WAS PRESENT AT THE TIME AND INSIDE [REDACTED] APARTMENT WERE LOCATED AN AR-15 AUTOMATIC WEAPON AND AN AUTOMATIC WEAPON KNOWN AS A MINI 14. ALSO LOCATED IN THE APARTMENT WERE FOUR CLIPS OF AMMUNITION, TWO BANANA STYLE AND TWO STRAIGHT STYLE. [REDACTED]

STATED THAT HE WAS AN ARTIST BY PROFESSION [REDACTED]

[REDACTED] PROVIDED HIS DATE OF BIRTH AS [REDACTED]

b6
b7C

[REDACTED] SUBSEQUENTLY PRODUCED A PERMIT FROM THE 102ND PRECINCT,

NEW YORK CITY, WHICH EXPIRES IN JULY 1981, INDICATING THAT

[REDACTED] HAS A PERMIT TO CARRY THE ABOVE WEAPONS.

WHEN ASKED AS TO WHY HE WAS IN POSSESSION OF THESE WEAPONS,

[REDACTED] STATED THAT HE WAS A "TARGET SHOOTER."

b6
b7C

DURING INTERVIEW, [REDACTED] STATED THAT HE HAD A FEMALE ASSOCIATE NAMED [REDACTED] WHO

WAS CURRENTLY RESIDING IN [REDACTED]
[REDACTED]

UNITED STATES STATE DEPARTMENT HAS ADVISED THAT IN VIEW OF THE HECTIC SITUATION DURING THE ENTRANCE OF [REDACTED]

b6
b7C

PAGE FIVE U N C L A S E T O

APARTMENT, AND THE SUBSEQUENT INTERVIEW, AND THE CHAOTIC SITUATION WHICH RESULTED AS A RESULT OF NUMEROUS STATE DEPARTMENT SPECIAL AGENTS AND NYCPD PERSONNEL, OFFICIALS, ETC., PRESENT, AN APPROPRIATE INTERVIEW OF [REDACTED] COULD NOT BE CONDUCTED AT THE TIME.

b6
b7C

FOR INFORMATION PURPOSES, THE NYCPD SEIZED [REDACTED] AR 15, MINI 14, AND ALL AMMUNITION, ALTHOUGH [REDACTED] HAD A PERMIT, AND THEY HAVE TOLD [REDACTED] THAT HE CAN RETRIEVE THE WEAPONS AND AMMUNITION ONCE FIDEL CASTRO LEAVES NEW YORK CITY.

UNITED STATES STATE DEPARTMENT HAS REQUESTED ASSISTANCE OF NYO, FBI, TO CONDUCT INTERVIEWS OF [REDACTED] [REDACTED] EVENING OF OCTOBER 10, 1979, AND SPECIFICALLY SPECIAL AGENTS FAMILIAR WITH ANTI-CASTRO ACTIVITIES. NYO WILL ASSIST STATE DEPARTMENT, IN ADDITION TO SECRET SERVICE AGENT, IN INTERVIEW OF [REDACTED] AND OTHERS THIS EVENING.

b6
b7C

IN ACCORDANCE WITH TELEPHONIC CONTACT WITH BUREAU, THE BUREAU IS REQUESTED TO IMMEDIATELY DISSEMINATE CONTENTS OF THIS TELETYPE [REDACTED]

b6
b7C
b7D
b7E

PAGE SIX U N C L A S E F T O

[REDACTED]

b6
b7C
b7D
b7E

~~ADDITIONALLY, THE BUREAU IS REQUESTED TO IMMEDIATELY
CONDUCT INDICES CHECKS RELATIVE TO THESE INDIVIDUALS AND ALSO
THE BUREAU IS REQUESTED TO~~ [REDACTED]

[REDACTED]

b3
b6
b7C
b7E

[REDACTED]

NYO NOTES THAT [REDACTED] ALTHOUGH COOPERATIVE,
WERE VERY COOL DURING INTERVIEW AND IN VIEW OF THE FACT THAT
THESE WEAPONS WERE IN THE POSSESSION OF [REDACTED] AND, MORE
IMPORTANTLY, THE WINDOW OF [REDACTED] LOOKS IMMEDIATELY DOWN ONTO
THE DOORWAY OF THE CUBAN AMBASSADOR'S RESIDENCE, THE NYO IS
MAKING EVERY EFFORT TO INSURE THAT THIS SITUATION IS UNDER
CONTROL AND HOW EXACTLY [REDACTED] AND POSSIBLY THE OTHERS QNOW
NASARIO SARGEN.

b6
b7C

ARMED AND DANGEROUS.

BT

#

Exec. AD-Inv.	_____
Exec. AD-Adm.	_____
Exec. AD-LES	_____
Asst. Dir.:	
Adm. Serv.	[redacted]
Crim. Inv.	[redacted]
Ident.	[redacted]
Insp.	[redacted]
Intell.	[redacted]
Laboratory	[redacted]
Legal Coun.	[redacted]
Plan. & Insp.	[redacted]
Rec. Mgnt.	[redacted]
Tech. Serv.	[redacted]
Training	[redacted]
Public Affs. Off.	[redacted]
Telephone Rm.	[redacted]
Director's Sec'y	[redacted]

b6
b7C

RECEIVED
TELETYPE UNIT

11 OCT 79 00 45z

RECEIVED
FEDERAL BUREAU
OF INVESTIGATION
COMMUNICATIONS SECTION

NY0264 2832340

RR HQ

DE NY 0037

R102301Z OCT 7

FM NEW YORK [redacted]

TO DIRECTOR (ROUTINE)

BT

~~CONFIDENTIAL~~

VISIT OF FIDEL CASTRO IN CONNECTION WITH THE UNGA, OCTOBER OF

1979; [redacted]

RENYTEL, DATED OCTOBER 9, 1979.

REFERENCED TELETYPE MISTAKENLY IDENTIFIED [redacted]

AS THE [redacted]

IS IN FACT [redacted]

[redacted]

[redacted] REC-124 [redacted]

C AND E 3441, REASON 2 AND 3, DRD OCTOBER 10, 1999.

BT

590 179

[redacted]

b6
b7C

over

b6
b7C

00 HI MM NK NY SP WT

DE SJ 0002

O 101938Z OCT 79

FM SAN JUAN [redacted] (185-70)

TO DIRECTOR [redacted] IMMEDIATE

ATTN: INTELLIGENCE DIVISION, CI-2 UNIT, AND CRIMINAL SECTION

INVESTIGATIVE DIVISION

MIAMI ROUTINE

NEWARK ROUTINE

NEW YORK IMMEDIATE

SAN FRANCISCO ROUTINE

WASHINGTON FIELD ROUTINE

BT

~~SECRET~~

SECTION 1 OF 2

[redacted] (OO: SAN JUAN)

CAZVIZ; PFO, (OO: NEW YORK)

REFERENCE SAN JUAN TELETYPE, OCTOBER 9, 1979, AND SAN JUAN TELEPHONE CALL TO BUREAU, OCTOBER 10, 1979.

185-1241-

[redacted]

b3
b6
b7C
b7E

NOT RECORDED
31 OCT 18 1979

TELETYPED TO
[redacted]

[redacted]

b6
b7C

970

[redacted]

Exec. AD-Inv.	_____
Exec. AD-Adm.	_____
Exec. AD-LES	_____
Asst. Dir.:	
Adm. Servs.	_____
Crim. Inv.	_____
Ident.	_____
Insp.	_____
Laboratory	_____
Legal Coun.	_____ b3
Plan. & Insp.	_____ b6
Rec. Mgnt.	_____ b7C
Tech. Servs.	_____ b7E
Training	_____
Public Affs. Off.	_____
Telephone Rm.	_____
Director's Sec'y	_____

b3
b6
b7C
b7E

ORIGINAL FILED IN

[redacted]

b3
b7E

THIS TELETYPE IS CLASSIFIED "~~SECRET~~" IN ITS ENTIRETY.

ON OCTOBER 9, 1979, [] ADVISED THAT AT

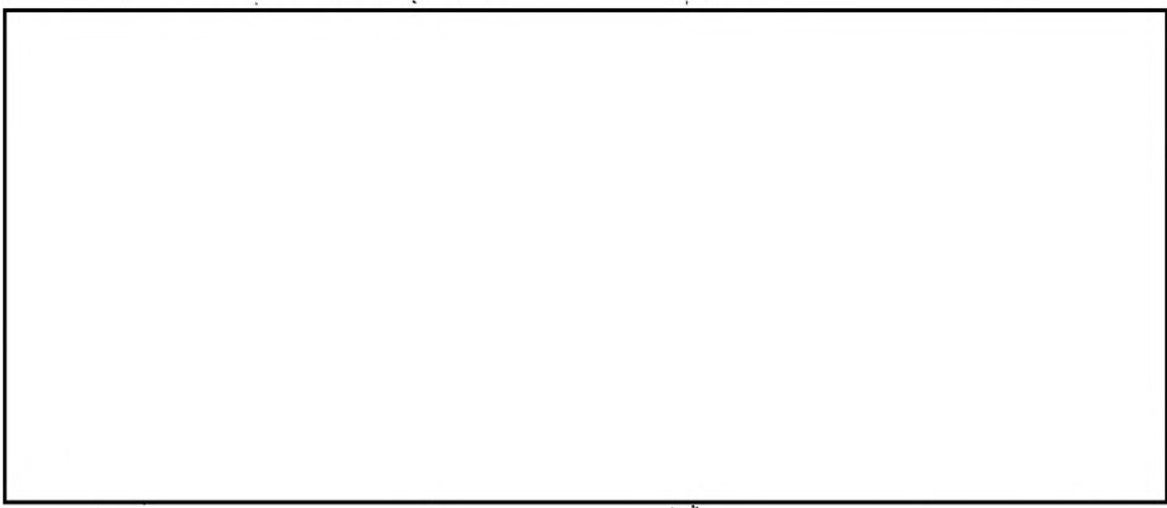

b3
b6
b7C
b7D

THE ASSET STATED []

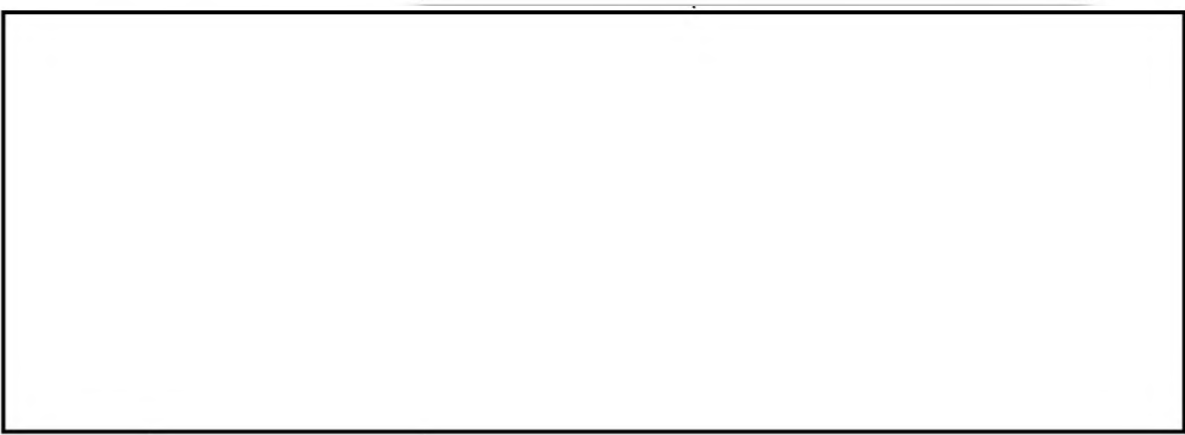

b3
b7D

[REDACTED]

b3
b6
b7C
b7D
b7E

[REDACTED]

FOR THE INFORMATION OF THE BUREAU AND NEW YORK, THE
ASSET BELIEVES THAT [REDACTED]

[REDACTED]

b3
b6
b7C
b7D

[REDACTED] SAN JUAN WILL KEEP INTERESTED
OFFICES EXPEDITIOUSLY ADVISED OF DEVELOPMENTS IN THIS MATTER.

[REDACTED]

WILL BE FORWARDED IN A FORM SUITABLE FOR DISSEMINATION.

~~C AND F, 8024, REASONS (2) AND (3), DRD OCTOBER 10, 1999.~~

BT

CC: C10

NYC250 2840147
PP HQ CG MM NK SF HI WF

DE NY 0049 [redacted]

PI02359Z OCT 79
FM NEW YORK (185-899) (M-10)

TO DIRECTOR PRIORITY

CHICAGO PRIORITY

MIAMI PRIORITY

NEWARK PRIORITY

SAN FRANCISCO PRIORITY

SAN JUAN PRIORITY (VA FBIHQ)

WASHINGTON FIELD PRIORITY

BT

UNCLAS E F T O

CAZVIZ; PFO; OO: NEW YORK.

RENYTEL, SEPTEMBER 10, 1979.

THE REFERENCED NEW YORK TELETYPE SET FORTH, THE CONTEXT

OF [redacted]

[redacted]

[redacted]

THE FOLLOWING IS

SET FORTH RELATIVE TO THAT DOCUMENT:

[redacted]

RECEIVED
TELETYPE UNIT

11 OCT 79 02 03z

RECEIVED
FEDERAL BUREAU
OF INVESTIGATION
COMMUNICATIONS SECTION

Exec. AD-Inv.	_____
Exec. AD-Adm.	_____
Exec. AD-LES	_____
Asst. Dir.:	
Adm. Servs.	_____
Crim.	[redacted]
Ident.	_____
Intell.	✓
Laboratory	_____
Legal Coun.	b6
Plan. & Insp.	b7C
Rec. Mgnt.	_____
Tech. Servs.	_____
Training	_____
Public Affs. Off.	_____
Telephone Rm.	_____
Director's Sec'y	_____

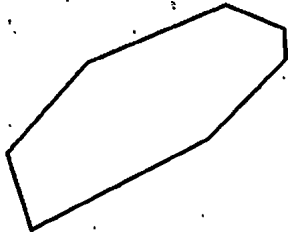
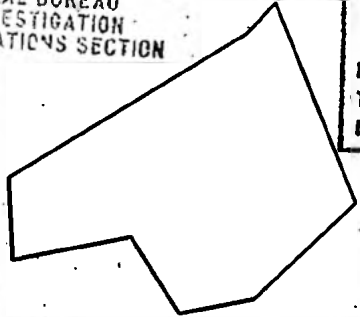

b6
b7C

b3
b6
b7C
b7E

REC-81

EX-138

185-1241-69

17 OCT 15 1979

b6
b7C

TELETYPE

64 OCT 31 1979

PAGE THREE U N C L A S E F T O

[REDACTED]

b6
b7C
b7E

[REDACTED]

FOR INFORMATION OF RECIPIENTS, ON OCTOBER 9, 1979, THE
BROOKLYN/QUEENS METROPOLITAN RESIDENCE AGENCY RECEIVED IN-
FORMATION FROM [REDACTED] RACKETS BUREAU, SUFFOLK
COUNTY DISTRICT ATTORNEYS OFFICE AS FOLLOWS:

A CONFIDENTIAL SOURCE OF HIS OFFICE WHO

[REDACTED]

[REDACTED]

b6
b7C
b7D

[REDACTED]

HAS BEEN

PAGE FOUR U N C L A Y E F T O.
FURNISHED TO THE BROOKLYN/QUEENS MRA.

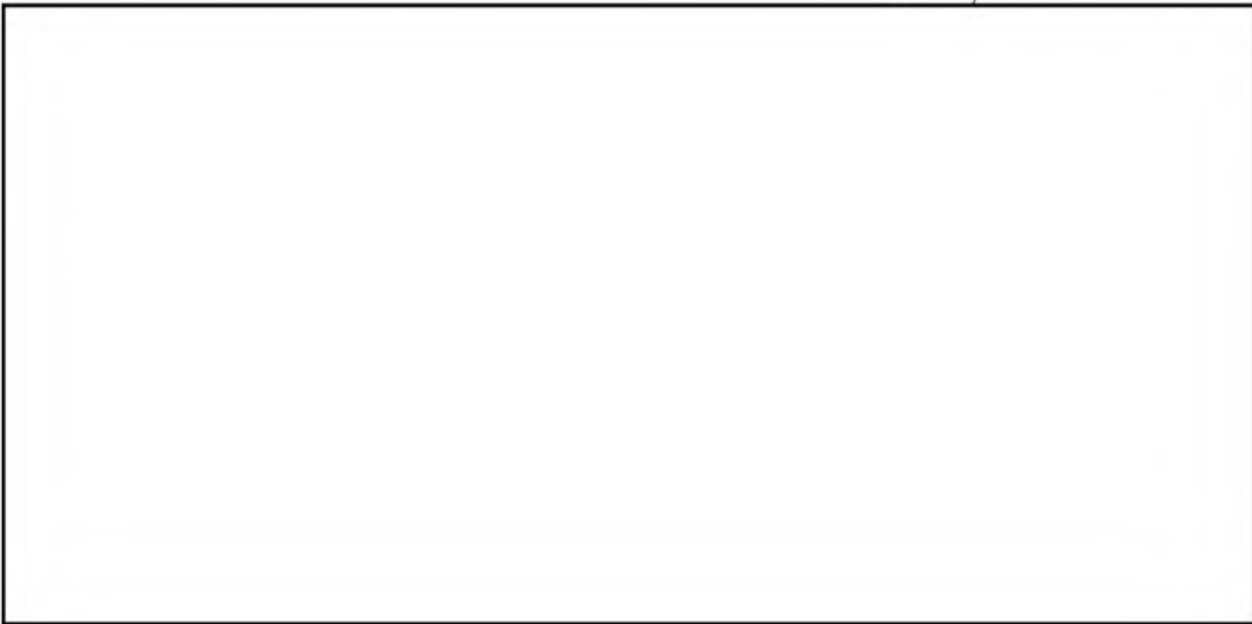

b6
b7C
b7D

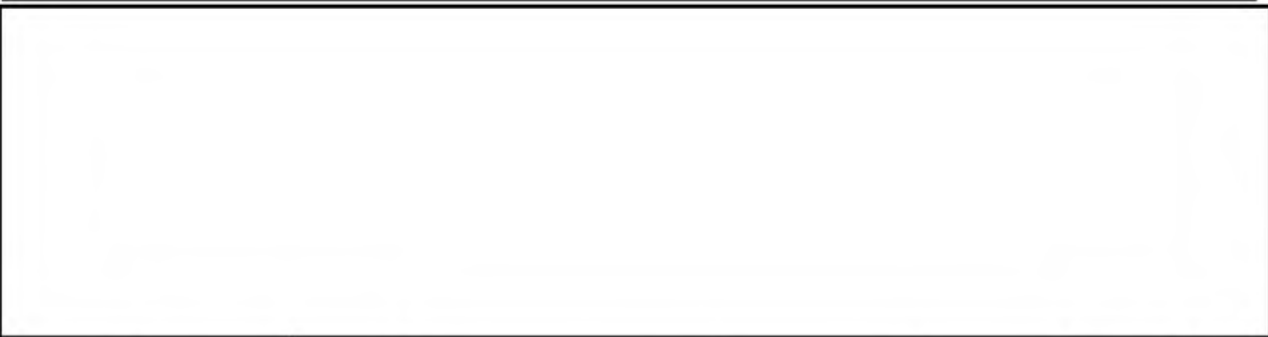

b6
b7C
b7D

[REDACTED] IS DESCRIBED AS A WHITE MALE, DOB: [REDACTED]

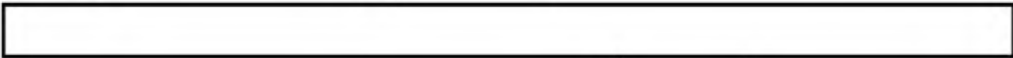

b6
b7C

PAGE FIVE U N C L A S E F T O

NYCPD NUMBER: [REDACTED]

b6
b7C

[REDACTED]

[REDACTED] IS DESCRIBED AS A
WHITE MALE, DOB: [REDACTED] ADDRESS: [REDACTED]

[REDACTED] HAS STATED THAT SOURCE

b6
b7C
b7D
b7E

[REDACTED]

[REDACTED] AND HE THEREFORE HAS NO

OBJECTION TO THE FBI AND USSS CONDUCTING ACTIVE INVESTIGATION
RELATIVE TO THIS PLOT.

SPECIAL AGENTS, NYO AND SPECIAL AGENTS, USSS, WILL LOCATE
AND INTERVIEW [REDACTED] EVENING OF OCTOBER 10,
1979, AND CONDUCT ANY ADDITIONAL INVESTIGATION WARRANTED.

b6
b7C

ADMINISTRATIVE:

THE ADMINISTRATIVE SECTION OF THIS TELETYPE IS CLASSIFIED
~~SECRET~~ IN ITS ENTIRETY.

REGARDING NEW YORK TELEPHONE CALLS TO THE BUREAU AND
SAN JUAN, OCTOBER 10, 1979, AND BUREAU TELEPHONE CALL TO
NEW YORK ON THE SAME DATE.

THE BUREAU ADVISED IN REFERENCED TELEPHONE CALL THAT

[REDACTED]

b3
b7D

PAGE SIX U N C L A S E F T O

b3
b6
b7C
b7D

[REDACTED]

FOLLOWING THE RECEIPT OF THIS INFORMATION FROM THE BUREAU,
NYO CASE AGENT CONTACTED SAN JUAN CASE AGENT AND ADVISED THAT
THE NYO AND USSS DESIRE TO RE-INTERVIEW ANDRES NAZARIO SARGEN
AND MENTION TO HIM, IN GENERAL TERMS, THAT WE ARE AWARE THAT HE
IS INVOLVED IN A PLOT AGAINST CASTRO. SAN JUAN CASE AGENT
ADVISED THAT [REDACTED]

b3
b7D

[REDACTED]

SPECIAL AGENTS, NYO AND SPECIAL AGENTS, USSS, WILL
ATTEMPT TO LOCATE AND INTERVIEW NAZARIO EVENING OCTOBER 10,
1979.

~~C AND E 5815, REASONS 2 AND 3, DRD OCTOBER 10, 1999.~~

BT

#

[Redacted]

RECEIVED
TELETYPE UNIT

Exec. AD-Inv.	
Exec. AD-Adm.	
Exec. AD-LES	
Asst. Dir.:	
Adm. Serv.	
Crim. Inv.	
Ident.	
Intell.	
Laboratory	
Legal Coun.	
Plan. & Insp.	
Rec. Mgnt.	
Tech. Serv.	
Training	
Public Affs. Off.	
Telephone Rm.	
Director's Sec'y	

b6
b7C

NK0011 2842112

RR HI MM NY SJ WF LA CG SF

11 Oct 79 21 20z

RECEIVED
FEDERAL BUREAU
OF INVESTIGATION
COMMUNICATIONS SECTION

DE NK 011

R 112112Z OCT 79

FM NEWARK (185-122) (P) (C-3)

TO DIRECTOR (ROUTINE)

MIAMI (ROUTINE)

NEW YORK (ROUTINE)

SAN JUAN (VIA FBIHQ) (ROUTINE)

WFO (ROUTINE)

LOS ANGELES (ROUTINE)

CHICAGO (ROUTINE)

SAN FRANCISCO (ROUTINE)

BT

UNCLAS E F T O

CAZVIZ; PFO; OO: NEW YORK

REC-124

185-1241-70

[Redacted]

b6
b7C

b3
b7E

RE BUREAU TELETYPE TO NEW YORK, OCTOBER 11, 1979.

ON OCTOBER 10, 1979, FBI, NEWARK REPRESENTATIVES ATTENDED

A U.S. SECRET SERVICE (USSS) STRATEGY SESSION REGARDING COORDINATING

b6
b7C
b7E

THE FOLLOWING INDIVIDUALS:

[Redacted]

10 OCT 15 1979

FBI, NEWARK WILL MAINTAIN LIAISON AND ASSIST USSS

TEAMS WITH BACKGROUND INFORMATION, AND WILL ASSIST

b6
b7C

TELETYPED

59 OCT 31 1979

PAGE TWO, NEWARK 185-122, UNCLAS E F T O

IN IDENTIFYING THE AFOREMENTIONED INDIVIDUALS THROUGHOUT THE CASTRO VISIT.

FOR INFORMATION OF THE BUREAU AND RECEIPT OFFICES, THE FOLLOWING IS SET FORTH BELOW RELATIVE TO THE COMMENTS ENUMERATED IN RE TELETYPE:

ITEM ONE - NEWARK REFERENCES TO [REDACTED] DID NOT UNCOVER ANY ADDITIONAL INFORMATION NOT ALREADY DISCLOSED IN RE COMMUNICATION.

b6
b7c

ITEM TWO AND THREE - APPLIES TO NEW YORK OFFICE.

ITEM FOUR - [REDACTED] (TRUE NAME [REDACTED]) WAS INTERVIEWED JOINTLY BY USSS AND FBI AGENTS ON OCTOBER 10, 1979. HE PRESENTLY RESIDES AT THE BEST WESTERN CHATEAU MOTOR INN, 2600 TONNELLE AVENUE, NORTH BERGEN, NJ, ROOM 311, TELEPHONE 201-866-0400. [REDACTED] ADVISED THAT HE WAS SCHEDULED TO CHECKOUT SOMETIME DURING OCTOBER 12, 1979, EN ROUTE TO EITHER CHICAGO OR MIAMI. HE ADVISED THAT HE WOULD BE AN ACTIVE PARTICIPANT IN THE ANTI-CASTRO DEMONSTRATION AT THE UNITED NATIONS ON OCTOBER 12, 1979. HE STATED THAT TO THE BEST OF HIS KNOWLEDGE IT WOULD BE A PEACEFUL BUT VERY VOCAL DEMONSTRATION. [REDACTED] FURTHER

b6
b7c

PAGE THREE, NEWARK 185-122, UNCLAS E F T O

INDICATED THAT IN THE PAST HE HAD PUBLICLY MADE THREATS AGAINST THE LIFE OF FIDEL CASTRO, HOWEVER, IT WAS MERELY FOR PUBLIC CONSUMPTION AND HE NEVER FELT THAT HE HAD THE ABILITY TO PERSONALLY CARRY OUT AN ATTEMPT ON CASTRO'S LIFE.

ITEM FIVE - A REVIEW OF NEWARK INDICES RE [REDACTED] NEGATIVE. EFFORTS TO BE MADE TO IDENTIFY HIM THROUGH SOURCES AND INFORMANTS.

b6
b7c

ITEMS SIX AND SEVEN - APPLY TO THE NEW YORK OFFICE.

ITEM EIGHT - FOR INFORMATION OF THE BUREAU, THERE ARE PRESENTLY AT LEAST 6 SPANISH PUBLICATIONS WITHIN THE NEW JERSEY-CUBAN EXILE COMMUNITY WHICH CHARACTERISTICALLY ADVOCATES THE ELIMINATION OF CASTRO. THE EMPLOYMENT OF VIOLENCE TO THIS END IS GENERALLY DEEMED JUSTIFIABLE IN LIGHT OF THE ATROCITIES ATTRIBUTED TO HIS REGIME.

ITEM NINE - APPLIED TO NEW YORK OFFICE.

ITEM TEN - [REDACTED] WAS INTERVIEWED BY USSS, NEWARK AGENTS ON OCTOBER 10, 1979, AT WHICH TIME HE DENIED ANY ACTIVE INVOLVEMENT WITH THE ANTI-CASTRO TERRORISTS IN ANY CAPACITY. NEWARK INDICES NEGATIVE RE

b6
b7c

PAGE FOUR, NEWARK 185-122, UNCLAS E F T O

IDENTIFICATION OF [REDACTED] AS AN ACTIVE ANTI-CASTRO
TERRORIST. IT SHOULD BE NOTED THAT [REDACTED] HAD BEEN
PREVIOUSLY INTERVIEWED BY NEWARK FBI AGENTS RE THE CHILBOM CASE
AND SUBSEQUENTLY CLEARED OF ALL SUSPICION.

b6
b7c

ITEMS LL, L2, AND 13 - APPLIES TO NEW YORK OFFICE.

BT

#

RECEIVED
TELETYPE UNIT

Exec. AD-Inv.	_____
Exec. AD-Adm.	_____
Exec. AD-LES	_____
Asst. Dir.:	
Adm. Serv.	_____
Intell.	_____
Laboratory	_____
Legal Coun.	_____
Plan & Insp.	_____
Rec. Mgnt.	_____
Tech. Servs.	_____
Training	_____
Public Affs. Off.	_____
Telephone Rm.	_____
Director's Sec'y	_____

b6
b7C

11 OCT 79 23 09z

RECEIVED
FEDERAL BUREAU
OF INVESTIGATION
COMMUNICATIONS SECTION

MM0020 284224 Z
PP HI NY NK SJ WF LA CG SF
DE MM

P 112247Z OCT 79
FROM MIAMI (185-126) P
TO DIRECTOR, FBI PRIORITY
NEW YORK PRIORITY
NEWARK PRIORITY
SAN JUAN (VIA WASHINGTON) PRIORITY
WASHINGTON FIELD PRIORITY
LOS ANGELES PRIORITY
CHICAGO PRIORITY
SAN FRANCISCO PRIORITY

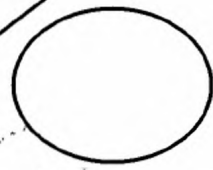
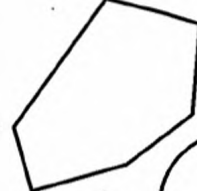
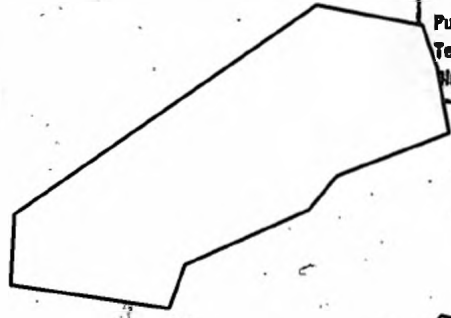

b6
b7C

BT

UNCLAS E F T O

CAZ VIZ; PFO. OO: NEW YORK.

EX-109

185-1241-71

REC-65

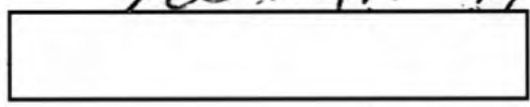

b3
b7E

RE BUTEL, OCTOBER 10, 1979, AND MIAMI TELETYPE, OCTOBER 11,

1979.

OCT 16 1979

REFERENCED BUTEL FURNISHED INFORMATION REGARDING A SECOND

DOCUMENT RECEIVED FROM USSS HEADQUARTERS

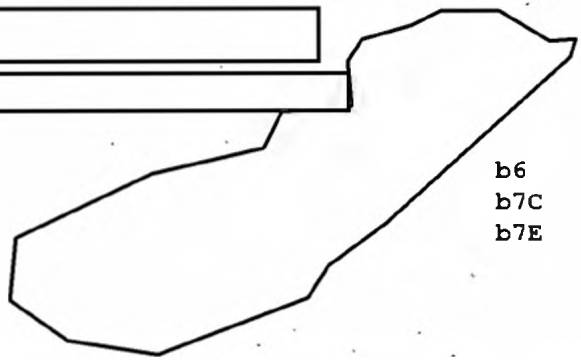
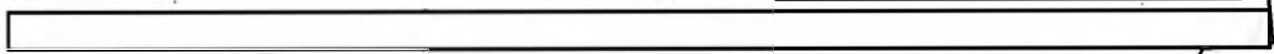
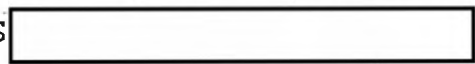

b6
b7C
b7E

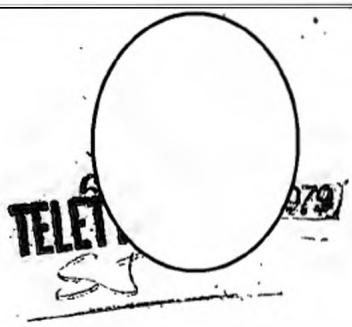

[REDACTED] SET FORTH ARE REPLY AND COMMENTS OF MIAMI REGARDING THE VARIOUS ITEMS FURNISHED [REDACTED]

b6
b7C
b7E

ITEM #1. APPLIES TO NEWARK OFFICE.

ITEM #2. [REDACTED] IS IN MIAMI, AND WAS INTERVIEWED BY USSS AND FBI. [REDACTED] HAS NOT BEEN LOCATED IN MIAMI. HOWEVER, A RELIABLE MIAMI SOURCE [REDACTED] ADVISED [REDACTED] SAID HE WAS GOING TO ALABAMA OVER ONE MONTH AGO WHERE HE WAS GOING TO BE INVOLVED IN SOME TYPE OF FISHING BUSINESS. THE SOURCE SAID HE IS SURE [REDACTED] IS NOT INVOLVED IN ANY ANTI-CASTRO ACTIVITY AT THIS TIME, AS [REDACTED] HAS JUST BEEN FREED FROM A CUBAN PRISON, AND IS EXPECTED TO BE ALLOWED TO LEAVE CUBA FOR THE U.S. ON OCTOBER 20, 1979. FOR THIS REASON, [REDACTED] WILL NOT DO ANYTHING AGAINST THE CUBAN GOVERNMENT FOR FEAR THAT [REDACTED] WILL NOT BE ALLOWED TO LEAVE CUBA.

b6
b7C

ITEM #3. [REDACTED] IS WELL KNOWN TO THE MIAMI OFFICE, AND WAS RECENTLY INTERVIEWED BY USSS AND FBI IN MIAMI, AT WHICH TIME NO INFORMATION OF VALUE WAS DEVELOPED.

b6
b7C

ITEM #4. APPLIES TO NEWARK OFFICE, AS [REDACTED] IS NOW IN NEW JERSEY.

PAGE THREE MM 185-126 UNCLAS E F T O

ITEM #5. THE MIAMI OFFICE HAS NO RECORD OF [REDACTED]

b6
b7C

ITEM #6. APPLIES TO NEW YORK OFFICE.

ITEM #7. ONLY SECTION OF THIS ITEM WHICH COULD APPLY TO MIAMI OFFICE IS THE MENTION OF FLORIDA LICENSE NUMBER [REDACTED]. THE DEPARTMENT OF MOTOR VEHICLES AT TALLAHASSEE, FLORIDA, ADVISES THAT THERE IS NO SUCH LICENSE NUMBER ISSUED IN FLORIDA.

ITEM #8. APPLIES TO NEW YORK OR NEWARK OFFICES.

ITEM #9. APPLIES TO NEW YORK OFFICE.

ITEM #10. APPLIES TO NEWARK OFFICE.

ITEMS #11, 12 AND 13. APPLY TO NEW YORK OFFICE.

[REDACTED] WAS REINTERVIEWED ON OCTOBER 11, 1979, BY USSS AND FBI. HE SAID HE DOES NOT INTEND TO TRAVEL TO NEW YORK DURING VISIT OF FIDEL CASTRO. IT IS NOTED THAT [REDACTED]

b6
b7C

[REDACTED]

INVESTIGATION CONTINUING AND RECEIVING OFFICES WILL BE ADVISED OF PERTINENT DEVELOPMENTS.

BT

#



RECEIVED
TELETYPE UNIT

b6
b7C

MMO 001 284 1528Z

11 OCT 79 15 52z

RECEIVED
FEDERAL BUREAU
OF INVESTIGATION
COMMUNICATIONS SECTION

Exec. AD-Inv.	_____
Exec. AD-Adm.	_____
Exec. AD-LES	_____
Asst. Dir.:	
Adm. Serv.	_____
Crim. Inv.	_____
Ident.	_____
Intell.	_____
Laboratory	_____
Legal Coun.	_____
Plan. & Insp.	_____
Rec. Mgnt.	_____
Tech. Servs.	_____
Training	_____
Public Affs. Off.	_____
Telephone Rm.	_____
Director's Sec'y	_____

b6
b7C

PP HQ NY NK SJ WF LA CCG SF

DE MM

P 11 1538Z OCT 79

FROM MIAMI (185-126) P
TO DIRECTOR FBI PRIORITY
NEW YORK PRIORITY

NEWARK PRIORITY

SAN JUAN (VIA WASHINGTON) PRIORITY

WASHINGTON FIELD PRIORITY

LOS ANGELES PRIORITY

CHICAGO PRIORITY

SAN FRANCISCO PRIORITY

BT

UNCLAS E F T O

CAZVIZ; PFO; OO: NEW YORK.

EX-125

185-1241-92

RE MIAMI TELETYPE, OCTOBER 10, 1979, [REDACTED]

REC-65

SET FORTH IS SUMMARY OF INVESTIGATION CONDUCTED ON OCTOBER 10,

1979, REGARDING CAPTIONED MATTER:

16 OCT 16 1979

b6
b7C

[REDACTED]

PHONED MIAMI FBI OFFICE

STATING THAT ONE [REDACTED]

[REDACTED]

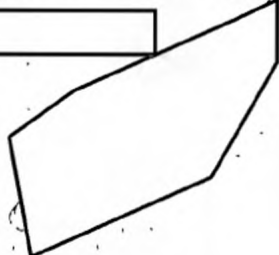

b6
b7C

b6
b7C

PAGE TWO MM 185-126 UNCLAS E F T O

[REDACTED] TOLD HER HE HAD PLACED AN INDIVIDUAL ON AN AIRPLANE ON OCTOBER 9, 1979, FOR PURPOSE OF KILLING FIDEL CASTRO IN NEW YORK CITY WITH EITHER AN M-1 OR M-16 RIFLE. [REDACTED] WAS LOCATED AND INTERVIEWED BY FBI. HE DENIED HE TOLD ANYONE HE HAD PLANNED TO HAVE SOMEONE KILL FIDEL CASTRO DURING HIS PROPOSED VISIT TO NEW YORK CITY, AND SAID HE HAD NOT PLACED ANYONE ON AN AIRPLANE, NOR DID HE HAVE KNOWLEDGE OF ANY PLOT TO HARM CASTRO. HE SAID PERSON WHO MADE COMPLAINT AGAINST HIM MUST HAVE MIS-INTERPRETED GENERAL STATEMENTS HE MADE ABOUT ANTI-CASTRO PERSONS WISHING HARM TO CASTRO. HE SAID HE DID DISCUSS SUCH GENERAL MATTERS WITH [REDACTED]

b6
b7C

[REDACTED] DESCRIBED AS FOLLOWS: WHITE, MALE, BORN [REDACTED]

b6
b7C

[REDACTED] RESIDES [REDACTED]

b6
b7C
b7E

[REDACTED] WAS INTERVIEWED BY U.S. SECRET SERVICE (USSS) AND FBI ON OCTOBER 10, 1979. [REDACTED] SAID HE KNOWS OF NO PLAN TO KILL FIDEL CASTRO, THAT HE DOES NOT PLAN TO TRAVEL

PAGE THREE MM 185-126 UNCLAS E F T O

TO NEW YORK, AND HE HAS NEVER MET [REDACTED]. HE SAID HE DOES NOT CONDUCT ANY TERRORIST-TYPE MEETINGS. HE KNOWS [REDACTED], BUT HAS NOT SEEN HIM IN THREE YEARS. HE SAID HE IS A MEMBER OF THE MOVIMIENTO INSURRECCIONAL MARTIANO (MIM), OF WHICH [REDACTED] IT IS NOTED THAT USSS AND FBI INTERVIEWED [REDACTED] LAST WEEK.

b6
b7C

ATTEMPTS ARE STILL BEING MADE TO INTERVIEW [REDACTED] [REDACTED]. [REDACTED] ADVISED USSS AND FBI THAT HE WORKS IN CONSTRUCTION, AND HE WILL HAVE [REDACTED] CONTACT FBI, AS HE IS IN MIAMI.

b6
b7C

ON OCTOBER 10, 1979, [REDACTED] (PROTECT PER REQUEST), MIAMI, ADVISED [REDACTED] [REDACTED] WOULD THROW GRENADES AT FIDEL CASTRO IN NEW YORK.

b6
b7C
b7D

AS RESULT OF ABOVE, NEWARK FBI TELEPHONICALLY ADVISED THEY INTERVIEWED A CONFIDENTIAL SOURCE WHO IS [REDACTED] [REDACTED] THIS SOURCE SAID THAT THERE IS NO TRUTH TO THIS ALLEGATION.

b7D

PRESENCE OF [REDACTED] VERIFIED IN MIAMI AS OF AFTERNOON, OCTOBER 10, 1979.

b6
b7C

PAGE FOUR MM 185-126 UNCLAS E F T O

INVESTIGATION CONTINUING AND BUREAU AND APPROPRIATE OFFICES
WILL BE ADVISED OF PERTINENT DEVELOPMENTS.

BT

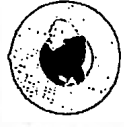

Exec. AD-Inv.	
Exec. AD-Adm.	b6
Exec. AD-LES	b7C
Asst. Dir.:	
Adm. Servs.	
Crim. Inv.	
Ident.	
Intell.	
Laboratory	
Legal Coun.	
Plan. & Insp.	
Rec. Mgnt.	
Tech. Servs.	
Training	
Public Affs. Off.	
Telephone Rm.	
Director's Sec'y	

RECEIVED
TELETYPE UNIT

11 Oct 79 22 05z

RECEIVED
FEDERAL BUREAU
OF INVESTIGATION
COMMUNICATIONS SECTION

NK0015 2842155

OO HI NY MM

DE NK 015

O 112155Z OCT 79

FM NEWARK (185-122) (P) (C-3)

TO DIRECTOR (IMMEDIATE)

NEW YORK (IMMEDIATE)

MIAMI (IMMEDIATE)

BT

~~SECRET~~

CAZVIZ; PFO; OO: NEW YORK

ON OCTOBER 11, 1979, [redacted]

ADVISED AS FOLLOWS: (S)

EX-109

b3
b6
b7C
b7D
b7E

185-1241-73

OCT 16 1979

b3
b6
b7C
b7E

Relay
to USSS,
US Customs,
FBI, SPS,
EPC, etc.

AGE TWO, NEWARK 185-122, ~~SECRET~~

SOURCE CAUTIONED THAT [REDACTED]

b3
b6
b7C
b7D

[REDACTED]
[REDACTED] ~~(S)~~ (U)
NEWARK INTENDS TO DISSEMINATE (WITH NO REF. TO [REDACTED])

[REDACTED] A PARAPHRASING OF THE ABOVE INFORMATION TO

b3
b6
b7C
b7D

USSS, NEWARK AND RECOMMENDS USSS, NEW YORK COORDINATE WITH
FBI, NEW YORK REGARDING FBI INVESTIGATION [REDACTED] ~~(S)~~ (U)

M KS

LEADS, NEW YORK, AT NEW YORK, NY: CONDUCT APPROPRIATE

INVESTIGATION AT [REDACTED]
[REDACTED]
[REDACTED]

b3
b7D

[REDACTED] ~~(S)~~ (U)

MIAMI, AT MIAMI, FLORIDA: THOUGH SOURCE COVERAGE, ATTEMPT

TO IDENTIFY [REDACTED] ~~(S)~~ (U)

NEWARK WILL REMAIN IN CLOSE CONTACT WITH SOURCE FOR ANY UP-

DATES INFORMATION. ~~(S)~~ (U)

C AND E 953, REASON 2 AND 3, OCTOBER 11, 1999.

BT

#

148

1

10/11/79

~~SECRET~~

IMMEDIATE

*F*H*P]***F*H*00 NYDE HQ HO146 *H*Y*STO 112305Z OCT 79

FM DIRECTOR FBI

TO FBI NEW YORK IMMEDIATE

BT

~~SECRET~~

[REDACTED]

b3
b7E

CAZVIZ; PFO

RENY SECURE TELCAL TO FBIHQ OCTOBER 11, 1979, AND FBIHQ

SECURE TELCAL TO NEW YORK OCTOBER 11, 1979. {U}

BY RETELCAL YOU REQUESTED AUTHORITY TO ADVISE [REDACTED]

[REDACTED]

b6
b7C
b7E

[REDACTED]

~~SECRET~~ U

FBIHQ HAS CAREFULLY CONSIDERED YOUR RECOMMENDATION THAT

[REDACTED]

[REDACTED]

[REDACTED]

{S}

10/11/79

4147/5

4605

b3
b6
b7C
b7E

1
1
1
1
1

[REDACTED]

SEE NOTE PAGE 4

185-1241-15

[REDACTED]

ORIGINAL FILED IN

ROUTED OCT 11 1979

NOT RECORDED

OCT 17 1979

59 OCT 1979

[REDACTED]

PAGE 2

CONTINUATION SHEET

PAGE TWO DE HQ 0146 ~~SECRET~~

[REDACTED]

b7E

[REDACTED]

~~(S)~~ (U)

IN ADDITION, FBIHQ IS IN POSSESSION OF INFORMATION IN THE

[REDACTED]

MATTER WHICH RAISES STRONG POSSIBILITY THAT

[REDACTED]

[REDACTED]

b3
b7D
b7E

[REDACTED]

IN VIEW OF PRECEDING,

[REDACTED]

[REDACTED]

b3
b7D
b7E

[REDACTED]

IMMEDIATELY

ADVISE FBIHQ.

~~(S)~~ (U)

~~C AND E 5236, REASONS 62, 31, DRD, OCTOBER 11, 1999.~~

BT

DO NOT TYPE MESSAGE BELOW THIS LINE

PAGE FOUR

[REDACTED]

TEL TO NY

10/11/79

~~SECRET~~

b3
b7E

NOTE:

By telcal 10/11/79, SAC MacFarlane, and Supervisor [REDACTED] NYO, contacted SA [REDACTED] CI-2D, and advised they wished to discuss captioned matter with regard to FBI responsibilities [REDACTED]

[REDACTED] They were requested to contact SA [REDACTED] by secure telephone. By re secure telcal, Supervisor [REDACTED] advised he and SAC, MacFarlane believed [REDACTED]

[REDACTED]

b3
b6
b7C
b7D
b7E

[REDACTED]

By secure telcal from FBIHQ to New York on 10/11/79, Supv. [REDACTED] was advised that FBIHQ [REDACTED]

[REDACTED]

b3
b6
b7C
b7D
b7E

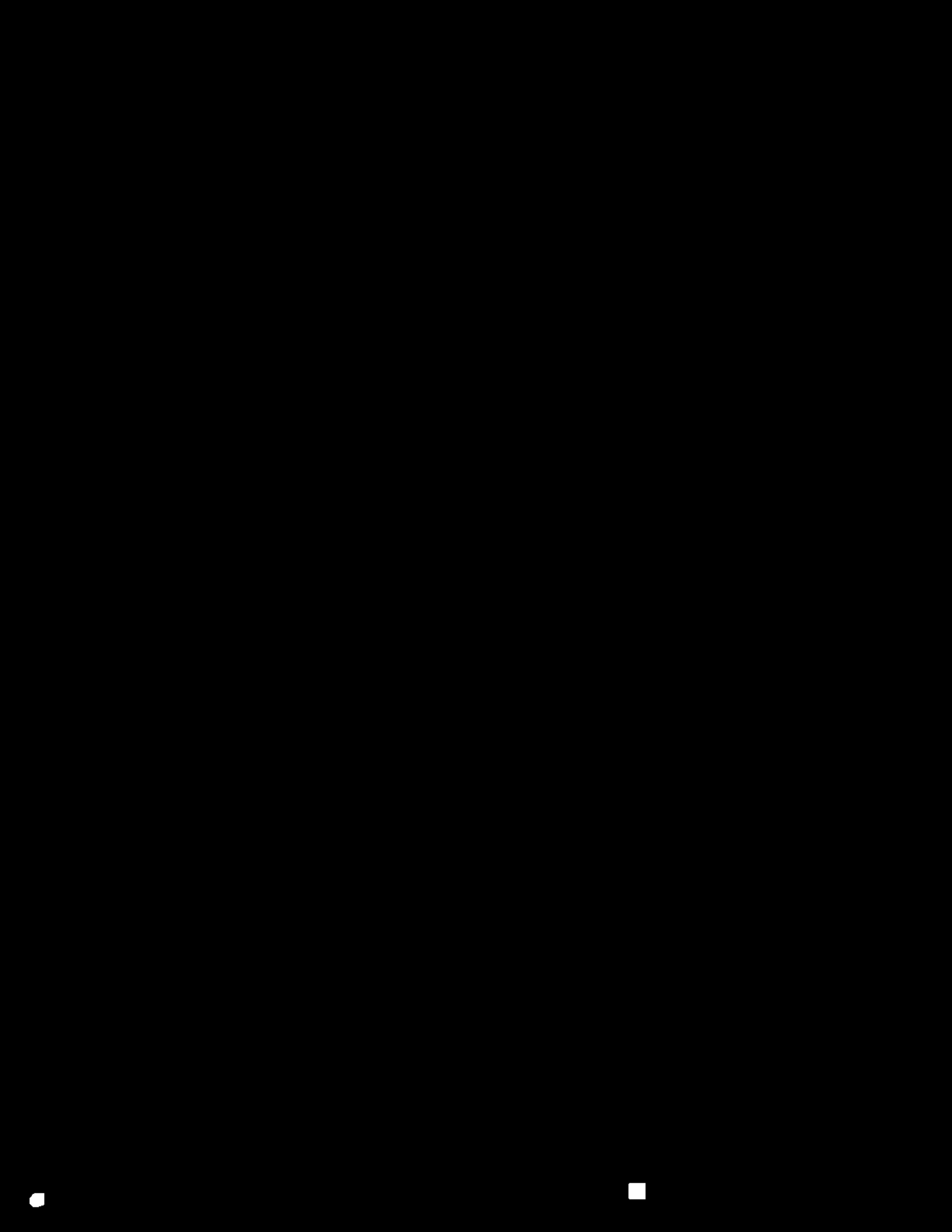

NYO: 65 2832342

PP [redacted]

DE NY 0038

PI02301Z OCT 79

FM NEW YORK [redacted]

TO DIRECTOR (PRIORITY)

BT

~~SECRET~~

RECEIVED
TELETYPE UNIT

11 OCT 79 00 47z

RECEIVED
FEDERAL BUREAU
OF INVESTIGATION
COMMUNICATIONS SECTION

Exec AD-Adm.	_____
Exec AD-Inv.	_____
Exec AD-LES	_____
Asst. Dir.:	
Adm. Serv.	_____
Crim. Inv.	_____
Ident.	_____
Insp.	_____
Laboratory	_____
Legal Coun.	_____
Plan. & Insp.	_____
Rec. Mgmt.	_____
Tech. Servs.	_____
Training	_____
Public Affs. Off.	_____
Telephone Rm.	_____
Director's Sec'y	_____

VISIT OF FIDEL CASTRO TO THE UNITED STATES IN CONNECTION WITH
THE UNGA, OCTOBER, 1979; [redacted]

A HIGHLY SENSITIVE CONFIDENTIAL SOURCE WHO HAS FURNISHED
RELIABLE INFORMATION IN THE PAST, ADVISED ON OCTOBER 9, 1979,

[Large redacted block]

DE-18

b3
b6
b7C
b7E

SOURCE ALSO INDICATED THAT [redacted]

REG-39

V-16

SI-126

185-1241-75
16 OCT 16 1979

0-73 fo [redacted]

USSR, USAS (7/8/79)

[Large redacted block]

59 OCT 13 1979

b3
b6
b7C
b7E

[Redacted]

[Redacted]

b3
b7E

[Redacted]

~~(S)~~ (U)

SOURCE FINALLY INDICATED THAT

[Redacted]

b3
b6
b7C
b7E

[Redacted]

[Redacted]

~~(S)~~ (U)

~~C AND E 3441, REASON 2 AND 3, DRD OCTOBER 10, 1999.~~

ADMINISTRATIVE

CONFIDENTIAL SOURCE IS

[Redacted]

b3
b6
b7C
b7E

[Redacted]

(LNU) IS POSSIBLY IDENTICAL TO

[Redacted]

[Redacted]

~~(S)~~ (U)

FBIHQ IS REQUESTED TO FURNISH ABOVE INFORMATION TO INTERESTED AGENCIES.

BT

#

SJ0215 2840216Z

PP HI CG LA MM NK NY WF

DE SJ

P 100216Z OCT 79

RECEIVED TELETYPE UNIT

11 OCT 79 5 6z

FEDERAL BUREAU OF INVESTIGATION COMMUNICATIONS SECTION

Exec. AD-Adm.	
Exec. AD-LES	
Asst. Dir.:	
Adm. Serv.	
Crim. Inv.	
Ident.	
Insp.	
Laboratory	
Legal Coun.	b6
Plan. & Insp.	b7C
Rec. Mgnt.	
Tech. Servs.	
Training	
Public Affs. Off.	
Telephone Rm.	
Director's Sec'y	

FM SAN JUAN (185-70) (P)

TO DIRECTOR PRIORITY

CHICAGO PRIORITY

LOS ANGELES PRIORITY

MIAMI PRIORITY

NEWARK PRIORITY

NEW YORK PRIORITY

SAN FRANCISCO PRIORITY

WASHINGTON FIELD PRIORITY

BT

UNCLAS E F T O

CAZVIZ; PFO, (OO: NEW YORK)

REC-65

601-X-109

✓ 185-1241-76

REFERENCE SAN JUAN TELETYPE, DATED SEPTEMBER 20, 1979,

ENTITLED "PROPOSED VISIT OF CUBAN PREMIER FIDEL CASTRO TO

THE UNITED STATES, OCTOBER, 1979; PFO MATTER, (OO: NEW YORK);

5 OCT 15 1979

BUREAU TELETYPE, DATED OCTOBER 8, 1979, ENTITLED "CAZVIZ".

b3
b6
b7C
b7E

b6
b7C

b6
b7C

PEP TO:1

64 1979

A REVIEW OF THE 22 ITEMS LISTED IN REFERENCED TELETYPE REVEALS THAT ONLY THOSE LISTED BELOW CAN BE ADDRESSED BY SAN JUAN:

ITEM 10: THIS MATTER IS UNDER INVESTIGATION BY SAN JUAN AND OTHER OFFICES. BOTH [REDACTED]

b6
b7C

[REDACTED] HAVE BEEN INTERVIEWED BY A TEAM OF FBI AND U.S. SECRET SERVICE AGENTS, WITH NO INDICATION BY EITHER MAN OF INTENTIONS TO DISRUPT IN ANY FASHION CASTRO'S VISIT TO NEW YORK.

ITEM 15: [REDACTED] ADVISED THAT [REDACTED]

b3
b6
b7C
b7D
b7E

LAST KNOWN ADDRESS IS [REDACTED]

b6
b7C

ITEM 17: SAN JUAN ADDRESSED THIS ITEM IN REFERENCED TELETYPE TO DIRECTOR, DATED SEPTEMBER 20, 1979.

PAGE THREE (185-70) UNCLAS E F T O

SAN JUAN IS CONTINUING TO LOCATE AND INTERVIEW ALL
KNOW ACTIVE AND INACTIVE MEMBERS OF ANTI-CASTRO ORGANIZATIONS
WHO COULD POSSIBLY CONSTITUTE A DANGER DURING THE VISIT OF
FIDEL CASTRO TO NEW YORK CITY.

BT

SP 0010 2842228

PP HQ NY

DE SL

P 112129Z OCT 79

FM ST. LOUIS (185-NEW) P

TO DIRECTOR PRIORITY

NEW YORK PRIORITY

BT

RECEIVED TELETYPE UNIT

2 OCT 79 00 12z

RECEIVED FEDERAL BUREAU OF INVESTIGATION COMMUNICATIONS SECTION

Exec. AD-Inv.	
Exec. AD-LES	
Exec. AD-LES	
Asst. Dir.:	
Adm. Serv.	
Crim.	
Ident.	
Intell.	
Laboratory	
Legal Coun.	
Plan. & Insp.	
Rec. Mgnt.	
Tech. Serv.	
Training	
Public Affs. Off.	
Telephone Rm.	
Director's Sec'y	

b6
b7C

UNCLAS E F T O

VISIT OF FIDEL CASTRO TO THE UNITED STATES; PFO.

~~RE ST. LOUIS TELETYPE, OCTOBER 11, 1979.~~
BY TELETYPE 10/11/79 FBI ST. LOUIS FURNISHED THE FOLLOWING:

ON FEBRUARY 15, 1979, A CONFIDENTIAL SOURCE, WHOSE RELIABILITY IS UNKNOWN, BUT WHO IS IN A POSITION TO KNOW, ADVISED THAT [REDACTED]

[REDACTED]

b6
b7C
b7D

ON SEPT. 14, 1979, SOURCE ADVISED THAT [REDACTED]

[REDACTED]

b6
b7C
b7D

OCT 1

3

SOURCE FURTHER ADVISED THAT

[REDACTED]

[REDACTED]

b6
b7C
b7D

ON OCT. 10, 1979, AT APPROXIMATELY 11:00 PM, SOURCE RECONTACTED

AT WHICH TIME HE ADVISED THAT

[REDACTED]

[REDACTED]

b6
b7C
b7D

REVIEW OF FBI, ST. LOUIS FILES, REFLECTED

[REDACTED]

b6
b7C

PAGE FOUR SL 185-NEW UNCLAS E F T O

DATE OF BIRTH [REDACTED] ARRIVED IN U.S. AT MIAMI, FLORIDA, DURING

b6
b7C

[REDACTED] ON AUG. 28, 1969, WITH FOLLOWING:

FAMILY MEMBERS: [REDACTED]

ON OCT. 11, 1979, AT APPROXIMATELY 1:00 AM, FBI AND U.S. SECRET SERVICE SPECIAL AGENTS LOCATED [REDACTED] RESIDENCE AT [REDACTED]

[REDACTED] AND SPOTTED A BROWN OVER TAN CHEVROLET BEARING

b6
b7C

[REDACTED] PARKED NEAR ABOVE RESIDENCE. UPON ARRIVAL

OF LOCAL ST. LOUIS POLICE DEPT. (SLPD) UNIFORMED OFFICERS, U.S. SECRET SERVICE AND FBI APPROACHED RESIDENCE AND WERE MET BY [REDACTED]

U.S. SECRET SERVICE (USSS) AGENT EXPLAINED SITUATION TO [REDACTED] IN

GENERAL TERMS AND ELICITED HIS COOPERATION. [REDACTED] WAS COOPERATIVE

AND INTERVIEW OF [REDACTED] WAS CONDUCTED BY USSS IN RESIDENCE.

b6
b7C

SHORTLY THEREAFTER [REDACTED] ARRIVED AT

RESIDENCE AND AFTER BEING ADVISED OF PURPOSE OF VISIT WERE COOPERATIVE WITH INTERVIEWING AGENTS.

THE FOLLOWING INFORMATION WAS OBTAINED DURING INTERVIEW OF ABOVE INDIVIDUALS:

NAME: [REDACTED]

b6
b7C

PAGE SIX SL 185-NEW UNCLAS E F T O

NONE OF THE ABOVE AWARE OF ANY THREATS TO DO HARM TO FIDEL CASTRO AND ADVISED THEY HAD NOT MADE ANY THREATENING STATEMENTS OR REMARKS TO THAT EFFECT, HOWEVER, THEY HAVE TALKED WITH FRIENDS OR ACQUAINTANCES ABOUT CASTRO AND CUBA.

DURING INTERVIEW IT WAS LEARNED THAT [REDACTED] HAD TAKEN CARS TO BE WORKED ON AT LOCAL GARAGE EARLY IN THE MORNING;

[REDACTED] HAD BEEN TO CUBA DURING THE EARLY PART OF AUGUST TO VISIT RELATIVES; THEY HAD TWO FIREARMS IN THE RESIDENCE, AND [REDACTED]

[REDACTED] MATCHED DESCRIPTIONS AS PROVIDED BY SOURCE. HOWEVER, NONE ADMITTED TO MEMBERSHIP IN ANY POLITICAL TYPE ORGANIZATIONS AND THOUGH ANTI-CASTRO POLITICALLY, WOULD NOT TAKE ACTION THEMSELVES TO REMOVE HIM. ABOVE INTERVIEW ENDED AND NO PROBLEMS OCCURRED.

b6
b7C

CHECK OF MISSOURI DOR ON OCT. 11, 1979, REVEALED THE FOLLOWING

[REDACTED] REGISTERED TO [REDACTED] [REDACTED] FOR A 1968 CHEVROLET.

b6
b7C

CHECK OF MO. DOR REGARDING ABOVE INDIVIDUALS REVEALED FOLLOWING INFORMATION:

NAME [REDACTED]

RACE: WHITE

SEX: MALE

b6
b7C

PAGE EIGHT SL 185-NEW UNCLAS E F T O

ADDRESS:

[REDACTED]

b6
b7C

NO REGISTERED VEHICLES AND SEVERAL MOTOR VEHICLE CITATIONS AND
CONVICTIONS.

NAME:

[REDACTED]

RACE:

WHITE

SEX:

MALE

DATE OF BIRTH:

[REDACTED]

HEIGHT:

WEIGHT:

b6
b7C

EYES:

SSAN:

ADDRESS:

NO REGISTERED VEHICLES AND TWO TRAFFIC CITATIONS AND CONVICTIONS.

LOCAL COMPUTER CRIMINAL AND NCIC CHECKS REGARDING ABOVE INDIVIDUALS NEGATIVE.

ADMINISTRATIVE:

~~SOURCE MENTIONED IN ABOVE IS~~ [REDACTED]

b7D

~~RECOMMENDED THAT ABOVE BE PROVIDED TO U.S. SECRET SERVICE,~~

~~WASHINGTON, D. C. FOR INFORMATION AND DISSEMINATION TO U.S. SECRET~~

PAGE NINE SL 185-NEW UNCLAS E F T O

~~SERVICE, ST. LOUIS.~~

~~NO FURTHER ACTION WILL BE TAKEN UACB.~~

BT

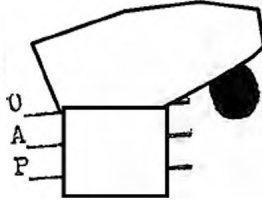

[redacted]

MESSAGE RELAY VIA TELETYPE

017

12

DATE 10/11/79	CLASSIFICATION CONFIDENTIAL	PRECEDENCE PRIORITY
------------------	---	------------------------

FM DIRECTOR FBI

FEDERAL GOVERNMENT

b3
b6
b7C
b7E

TO

old page 3

[Large redacted area]

[redacted]

185-1241-79

(SERVICE ALSO AVAILABLE TO GOVERNMENT AGENCIES NOT LISTED.
CONTACT COMMUNICATIONS CENTER FOR ADDRESSING INFORMATION)
SUBJECT:

SEE ATTACHED

REC-106

19 OCT 15 1979

b3
b6
b7C
b7E

APPROVED BY [redacted]	ORIGINATOR [redacted]	ROOM 5027	TELE EXT. 2805
---------------------------	--------------------------	--------------	-------------------



5900

[redacted]

FEDERAL BUREAU OF INVESTIGATION
COMMUNICATIONS SECTION
0723
OCT 12 1979

b6
b7C

DO NOT FILE WITHOUT COMMUNICATIONS STAMP

USE OF FORM 0-73

1. Only incoming teletype messages which require transmission relay may be prepared for transmission using form 0-73. Use of form 0-73 is restricted to incoming teletype messages received within the last 3 days which require transmission relay; all other teletype messages must be prepared using form 0-93.
2. Additions such as notes and administrative data for a specific addressee are not allowed. If a note or administrative data is required for a particular addressee a separate 0-73 form must be prepared.
3. The message will be transmitted just as it appears. The person approving the message is solely responsible for assuring all necessary editing changes have been made.

PREPARATION OF FORM WHICH CONSISTS OF A PREPRINTED YELLOW.

1. Complete appropriate boxes: date, classification & precedence.
2. List addresses immediately following the "TO" or place a check mark in the appropriate boxes.
3. Type or PRINT the subject in the space provided.
4. Print or type originator's name, room number and telephone extension.
5. Indicate approval for transmission by initialing the "Approved By" box.

12 OCT 79 03 12
RECEIVED
FEDERAL BUREAU
OF INVESTIGATION
COMMUNICATIONS SECTION

PREPARATION OF MESSAGE TO BE TRANSMITTED

1. Xerox 1 copy of incoming teletype message. A notation shall be made on the original incoming teletype "1 copy made for relay to SACS _____, (OR LEGATS) _____, (OR GOVERNMENT AGENCIES) _____."
2. Minor editing changes shall be made on the xerox as follows: using a lead pencil ONLY draw single line through the first and last lines of the heading and connect these lines from top right to bottom left forming a "Z," figure. (DO NOT OBLITERATE THE HEADING.) Use horizontal lines to delete sentences or words. Printed changes of a word or two to the text of the message may be made; however, changes to the existing text involving more than a word or two necessitate the originator to initiate a new message using form 0-93.
3. Administrative data or notes may be typed immediately following the text and will be transmitted to all addressees.
4. When using the 0-73 form to disseminate information to field offices, Legal Attaches and other Government agencies simultaneously, the text, notes and administrative data must be identical for all addressees.

NK0016 2850100

PP HI NY MM

DE NK 016

P 120100Z OCT 79

FM NEWARK (185-122) (G-3) (P)

TO DIRECTOR (PRIORITY)

NEW YORK (PRIORITY)

MIAMI (PRIORITY)

BT

RECEIVED
TELETYPE UNIT

12 OCT 79 01 06z

RECEIVED
FEDERAL BUREAU
OF INVESTIGATION
COMMUNICATIONS SECTION

Exec. AD-Inv.	_____
Exec. AD-Adm.	_____
Exec. AD-LES	_____
Asst. Dir.:	
Adm. Servs.	_____
Crim. Inv.	_____
Ident.	_____
Intell.	_____
Laboratory	_____
Legal Coun.	_____
Plan. & Insp.	_____
Rec. Mgmt.	_____
Tech. Servs.	_____
Training	_____
Public Affs. Off.	_____
Telephone Rm.	_____
Director's Sec'y	_____

b6
b7C

~~CONFIDENTIAL~~

CAZVIZ; PFO: 00: NEW YORK
BY TELETYPE 10/11/79. FBI NEWARK FURNISHED THE FOLLOWING:

ON OCTOBER 11, 1979,

ADVISED AS FOLLOWS:

b3
b6
b7C
b7D

C AND E 955, REASON 2 AND 3, OCTOBER 11, 1999.

4478

BT

#

b6
b7C

[redacted] 086
[redacted]

U
A
P
[redacted]

MESSAGE RELAY VIA TELETYPE

DATE 10/11/79	CLASSIFICATION SECRET	PRECEDENCE PRIORITY
------------------	-------------------------------------	------------------------

FM DIRECTOR FBI
TO SAC NY

b3
b6
b7C
b7E

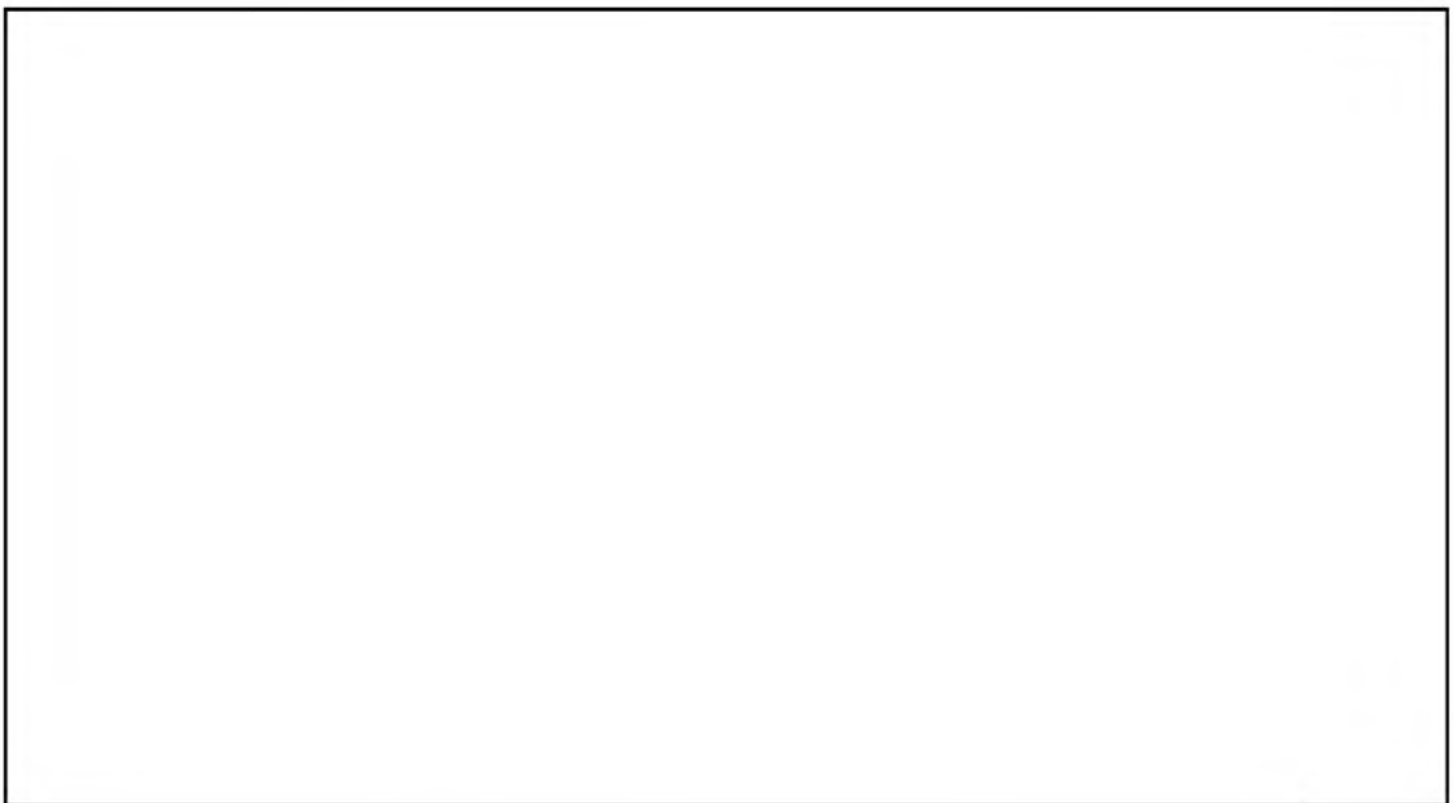

(SERVICE ALSO AVAILABLE TO GOVERNMENT AGENCIES NOT LISTED.
CONTACT COMMUNICATIONS CENTER FOR ADDRESSING INFORMATION)

185-1241-80

SUBJECT:
CAZVIZ

REC-39

[redacted]

b3
b6
b7C
b7E

EX-138

OCT 12 1979

[redacted]

ORIGINATOR [redacted]	ROOM 4048	TELE EXT. 4660
--------------------------	--------------	-------------------

660

FEDERAL BUREAU OF INVESTIGATION
COMMUNICATIONS SECTION

OCT 12 1979

[redacted]

DO NOT FILE WITHOUT COMMUNICATIONS STAMP

USE OF FORM 0-73

1. Only incoming teletype messages which require transmission relay may be prepared for transmission using form 0-73. Use of form 0-73 is restricted to incoming teletype messages received within the last 3 days which require transmission relay; all other teletype messages must be prepared using form 0-93.
2. Additions such as notes and administrative data for a specific addressee are not allowed. If a note or administrative data is required for a particular addressee a separate 0-73 form must be prepared.
3. The message will be transmitted just as it appears. The person approving the message is solely responsible for assuring all necessary editing changes have been made.

PREPARATION OF FORM WHICH CONSISTS OF A PREPRINTED YELLOW.

1. Complete appropriate boxes: date, classification & precedence.
2. List addresses immediately following the "TO" or place a check mark in the appropriate boxes.
3. Type or PRINT the subject in the space provided.
4. Print or type originator's name, room number and telephone extension.
5. Indicate approval for transmission by initialing the "Approved By" box.

PREPARATION OF MESSAGE TO BE TRANSMITTED

1. Xerox 1 copy of incoming teletype message. A notation shall be made on the original incoming teletype "1 copy made for relay to SACS _____, (OR LEGATS) _____, (OR GOVERNMENT AGENCIES) _____."
2. Minor editing changes shall be made on the xerox as follows: using a lead pencil ONLY draw single line through the first and last lines of the heading and connect these lines from top right to bottom left forming a "Z," figure. (DO NOT OBLITERATE THE HEADING.) Use horizontal lines to delete sentences or words. Printed changes of a word or two to the text of the message may be made; however, changes to the existing text involving more than a word or two necessitate the originator to initiate a new message using form 0-93.
3. Administrative data or notes may be typed immediately following the text and will be transmitted to all addressees.
4. When using the 0-73 form to disseminate information to field offices, Legal Attaches and other Government agencies simultaneously, the text, notes and administrative data must be identical for all addressees.

EL 0016 284064

RECEIVED TELETYPE UNIT

PP HQ NY

11 OCT 79 11 14z

DE SL

RECEIVED
FEDERAL BUREAU OF INVESTIGATION
COMMUNICATIONS SECTION

P 110636Z OCT 79

FM ST. LOUIS (185-NEW)

TO DIRECTOR PRIORITY

NEW YORK PRIORITY

BT

UNCLAS E F T O

VISIT OF FIDEL CASTRO TO THE UNITED STATES, PFO.

Exec. AD-Inv.	
Exec. AD-Adm.	
Exec. AD-LES	
Asst. Dir.:	
Adm. Serv.	
Crim. Inv.	
Ident.	
Intell.	
Laboratory	
Legisl. Coun.	
Plan. & Insp.	
Rec. Mgnt.	
Tech. Servs.	
Training	
Public Affs. Off.	
Telephone Rm.	
Director's Sec'y	

b6
b7C

2

b6
b7C
b7D

ON 2/15/79, [REDACTED] WHOSE RELIABILITY IS UNKNOWN BUT WHO IS

IN A POSITION TO KNOW, ADVISED THAT [REDACTED]

[REDACTED]

[REDACTED]

ON 9/14/79, [REDACTED] ADVISED [REDACTED]

[REDACTED]

[REDACTED]

ON 10/10/79, [REDACTED] ADVISED THAT [REDACTED]

[REDACTED]

b6
b7C
b7D

185-1241-81

b6
b7C
b7D

[REDACTED]

b6
b7C

64 00 879

b6
b7C
b7D

[REDACTED]
ST. LOUIS INDICES REFLECT [REDACTED] AND FAMILY

ARRIVED IN U.S. AT MIAMI, FLORIDA ON 8/28/69, [REDACTED]

[REDACTED] ALONG WITH [REDACTED] THE FOLLOWING FAMILY MEMBERS:

b6
b7C

[REDACTED]

THE ABOVE INFORMATION HAS BEEN PROVIDED TO U.S.S.S., ST. LOUIS.
FBI AND USSS, ST. LOUIS WILL COORDINATE INVESTIGATION AND FURTHER
INFORMATION WILL FOLLOW ON AM 10/11/79.

BT

0517 2340224Z

RECEIVED
TELETYPE UNIT

RR HI CG LA MM NK NY SF WF

DE SJ

11 OCT 79 15 00 Z

R 100225Z OCT 79

FEDERAL BUREAU OF INVESTIGATION
COMMUNICATIONS SECTION

Exec AD-Adm.	
Exec AD-LES	
Asst. Dir.:	
Adm. Serv.	
Crim. Inv.	
Ident.	
Insp.	
Intell.	
Laboratory	
Legal Coun.	
Plan. & Insp.	
Rec. Mgnt.	
Tech. Servs.	
Training	
Public Affs. Off.	
Telephone Rm.	
Director's Sec'y	

b6
b7C

FM SAN JUAN (185-70) (P)

TO DIRECTOR ROUTINE

ATTN: CRIMINAL INVESTIGATION DIVISION AND INTELLIGENCE

DIVISION, CI-2 UNIT

CHICAGO ROUTINE

LOS ANGELES ROUTINE

MIAMI ROUTINE

NEWARK ROUTINE

NEW YORK ROUTINE

SAN FRANCISCO ROUTINE

WASHINGTON FIELD ROUTINE

BT

UNCLAS E F T O

CAZVIZ; PFO; (OO: NEW YORK)

REFERENCE SAN JUAN TELETYPE TO DIRECTOR, DATED

OCTOBER 9, 1979, ENTITLED "CAZVIZ".

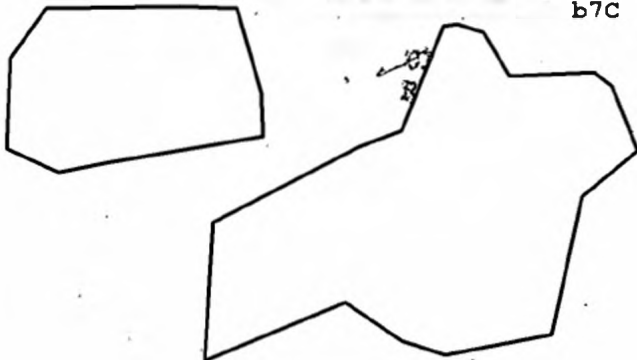

b6
b7C

185-1241-82

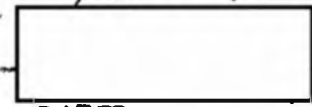

b3
b6
b7C
b7E

REC 20

EX-138

15 OCT 15 1979



b6
b7C

TELETYPED TO:

64 NOV



PAGE TWO (185-70) UNCLAS E F T O

JOINT INTERVIEWS CONTINUED TO BE CONDUCTED BY FBI,
SAN JUAN, AND U.S. SECRET SERVICE, SAN JUAN, OF KNOWN
ACTIVE AND INACTIVE ANTI-CASTRO CUBAN EXILES.

THE FOLLOWING ARE THOSE INDIVIDUALS WHO HAVE BEEN
CONTACTED AND INTERVIEWED ON OCTOBER 10, 1979:

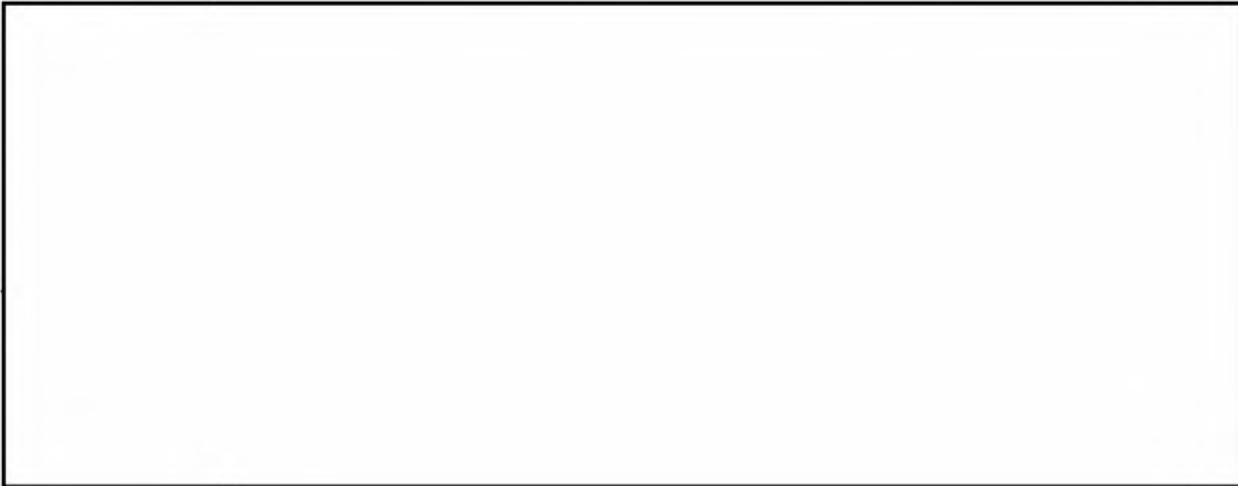

b6
b7C



b6
b7C

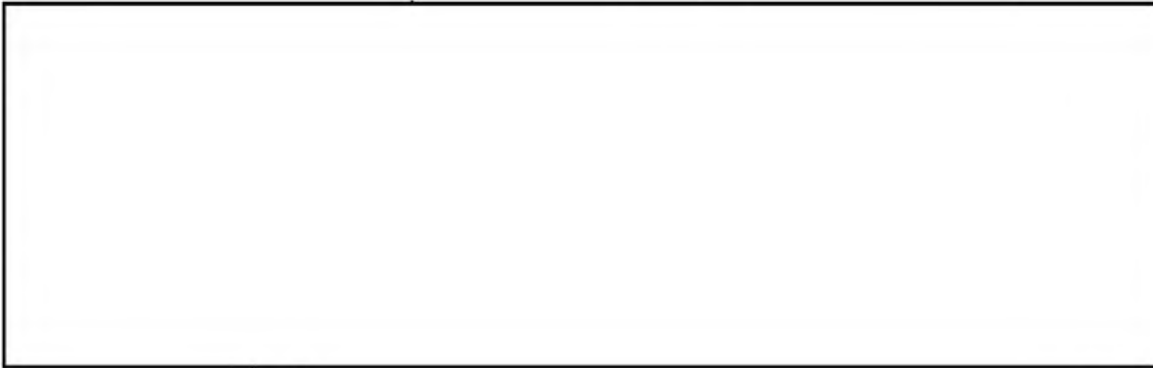

b6
b7C



b6
b7C

ALL THE ABOVE DENIED BEING INVOLVED IN ANY PLANS OR
HAVING KNOWLEDGE OF ANY PLANS CONCERNING THE VISIT OF FIDEL
CASTRO TO THE UNITED STATES.

THE BELOW LISTED INDIVIDUALS HAVE NOT BEEN LOCATED
AND INTERVIEWED:

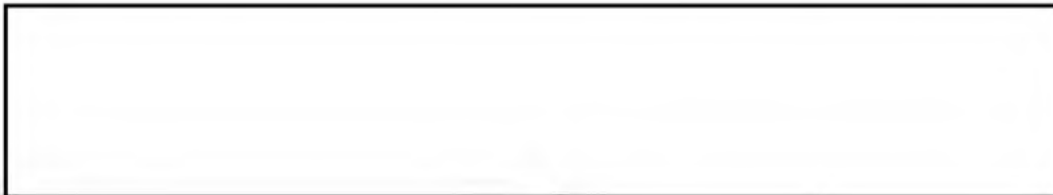

b6
b7C



(IT SHOULD BE NOTED THAT

PAGE FOUR (185-70). UNCLAS E F T O

AN INDIVIDUAL IDENTIFYING HIMSELF AS [REDACTED] CALLED
THE U.S. SECRET SERVICE OFFICE IN SAN JUAN ON THE EVENING
OF OCTOBER 9, 1979, AND ADVISED THAT HE HAD INTENTIONS OF
LEAVING PUERTO RICO FOR NEW YORK CITY ON SOME SORT OF
BUSINESS VENTURE. THIS INDIVIDUAL WAS CLASSIFIED BY THE
U.S. SECRET SERVICE OPERATOR AS BEING HIGHLY INTOXICATED).

b6
b7c

SAN JUAN WILL CONTINUE IN ITS ATTEMPTS TO LOCATE AND
INTERVIEW ABOVE INDIVIDUALS.

BT

CC-01-2

#

11

RECEIVED
TELETYPE UNIT

Exec. AD-Inv.		
Exec. AD-Adm.		
Exec. AD-LES		
Asst. Dir.:		
Adm. Servs.		
Crim. Inv.		b6
Ident.		b7C
Intell.		
Laboratory		
Legal Coun.		
Plan. & Insp.		
Rec. Mgnt.		
Tech. Servs.		
Training		
Public Affs. Off.		
Telephone Rm.		
Director's Sec'y		b6
		b7C

NY0275 2840111

PP HQ CG, LA NK SF HI WF
DE NY 0026

PI02130Z OCT 79

FM NEW YORK (185-899) (M-10)

TO DIRECTOR PRIORITY

CHICAGO PRIORITY

LOS ANGELES PRIORITY

NEWARK PRIORITY

SAN FRANCISCO PRIORITY

SAN JUAN PRIORITY (VIA FBIHQ)

WASHINGTON FIELD PRIORITY

BT

U N C L A S E F T O

CAZVIZ; PFO; OO: NEW YORK.

ON OCTOBER 9, 1979, UNITED STATES SECRET SERVICE (USSS)

NEW YORK, NEW YORK, FURNISHED THE NYO WITH A TRANSLATED COPY

[Large redacted area]

185-1241-83
11 OCT 18 1979
b3
b6
b7C
b7E

TELETYPE

64 NOV 2 1979

[Redacted box]

b6
b7C

PAGE FIVE U N C L A S T V E F T O

b6
b7C
b7E

THE NYO ALONG WITH USSS IS CURRENTLY ANALYZING AND CHECKING
OUT THE INFORMATION ABOVE AND RECIPIENT OFFICES ARE REQUESTED
TO DO THE SAME.

BT

#

DEPARTMENT OF JUSTICE
FEDERAL BUREAU OF INVESTIGATION
COMMUNICATION MESSAGE FORM

b6
b7C

0-93 128 4-26-78

128

PAGE 1 OF 11

DATE 10-12-79

CLASSIFICATION UNCLAS E F T O

PRECEDENCE ROUTINE

FM1270RR CG LA MM NK NY SF SJ WFOE HQ 10127 #d

WEUR 122147Z OCT 79

FM DIRECTOR FBI

FM

TO FBI NEW YORK ROUTINE

TO

FBI NEWARK ROUTINE

14

FBI MIAMI ROUTINE

FBI SAN JUAN ROUTINE

12

FBI LOS ANGELES ROUTINE

FBI WASHINGTON FIELD ROUTINE

10

FBI SAN FRANCISCO ROUTINE

FBI CHICAGO ROUTINE

8

BT

UNCLAS E F T O

su 102

CAZVIZ; PFO; OO: NEW YORK.

REFERENCE BUREAU TELETYPE DATED OCTOBER 10, 1979.

USSS HEADQUARTERS PROVIDED THE FOLLOWING INFORMATION WHICH

[Redacted area]

DO NOT TYPE PAST THIS LINE

b6
b7C
b7E

DO NOT TYPE MESSAGE BELOW THIS LINE

APPROVED BY

[Signature]

DRAFTED BY

[Redacted]

DATE

10-12-79

ROOM

4051

TELE EXT.

4632

- 1 - [Redacted]
- 1 - [Redacted]
- 1 - [Redacted]
- 1 - [Redacted]
- 1 - [Redacted]
- 1 - [Redacted]

SEE NOTE ON PAGE 12 - 105-1241-84

REC-137

OCT 15 1979

b3
b6
b7C
b7E

FEDERAL BUREAU OF INVESTIGATION
COMMUNICATIONS SECTION

OCT 13 1979

30 1979

DO NOT FILE WITHOUT COMMUNICATIONS STAMP

FBI/DOJ

NK0006 2861937
PP HI NY MM
DE NK
P 121938Z OCT 79
FM NEWARK (185-122) (P) (C-3)
TO DIRECTOR (PRIORITY)
NEW YORK (PRIORITY)
MIAMI (PRIORITY)
BT

RECEIVED
TELETYPE UNIT

12 OCT 79 29 00z

RECEIVED
FEDERAL BUREAU
OF INVESTIGATION
COMMUNICATIONS SECTION

Exec. AD-Inv.	
Exec. AD-Adm.	
Exec. AD-LES	
Asst. Dir.:	
Adm. Servs.	
Crim. Inv.	
Ident.	
Intell.	
Laboratory	
Legal Coun.	
Plan. & Insp.	
Rec. Mgnt.	
Tech. Servs.	
Training	
Public Affs. Off.	
Telephone Rm.	
Director's Sec'y	

b6
b7C

~~SECRET~~

CAZVIZ; PFO; OO: NY

RE: NEWARK TEL, OCTOBER 11, 1979. (U)

ON OCTOBER 12, 1979, [redacted] RELIABLE,

ADVISED AS FOLLOWS: ~~(S)~~ U

[Large redacted block]

b6
b7C
b7D

b6
b7C
b7D

0 13 to
W.A. NSE
Guss; DOT; USC;
PAA; ST; DAB; GPC
ARK; CG; ISS
10/12/79

REC 11

[redacted] 185-1241-85

b3
b6
b7C
b7E

EX-138

15 OCT 15 1979

[Large redacted block]

6 OCT 1979

b7D

[REDACTED]

[REDACTED]

~~(S)~~ (U)

SOURCE WAS NOT ABLE TO ELABORATE ON INFORMATION HE FURNISHED ON OCTOBER 11, 1979, REGARDING [REDACTED]

b7D

[REDACTED]

~~(S)~~ (U)

SOURCE STATED THAT [REDACTED]

b6
b7C
b7D

[REDACTED]

[REDACTED]

~~(S)~~ (U)

[REDACTED]

~~(S)~~ (U)

~~C AND E 953, FCIM 2 AND 3, OCTOBER 12, 1999~~

BT

Exec. AD-Inv.	_____
Exec. AD-Adm.	_____
Exec. AD-LES	_____
Asst. Dir.:	
Adm. Serv.	_____
Crim. Inv.	_____
Ident.	_____
Intell.	_____
Laboratory	_____
Legal Coun.	_____
Plan. & Insp.	_____
Rec. Mgnt.	_____
Tech. Servs.	_____
Training	_____
Public Affs. Off.	_____
Telephone Rm.	_____
Director's Sec'y	_____

b6
b7C

RECEIVED
TELETYPE UNIT

11 OCT 79 04 21 z
RECEIVED
FEDERAL BUREAU
OF INVESTIGATION
COMMUNICATIONS SECTION

LA0120 2840354Z
PP HQ AT MM NK NY
DEL A019
P 110354Z OCT 79

FM LOS ANGELES (185-273) (11) (P)

TO DIRECTOR PRIORITY

ATLANTA PRIORITY

MIAMI PRIORITY

NEWARK PRIORITY

NEW YORK PRIORITY

BT

~~SECRET~~

CAZVIZ, PFO, OO: NEW YORK

RE BUREAU TELETYPE DATED OCTOBER 8, 1979 AND NEW YORK
TELETYPE DATED OCTOBER 9, 1979.

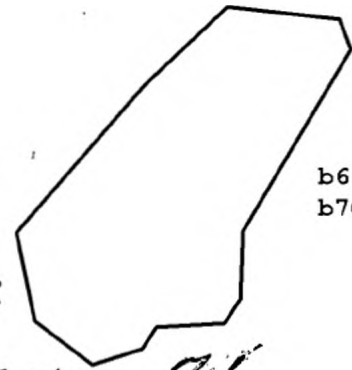

b6
b7C

185-1241-86

THE FOLLOWING FIVE INDIVIDUALS WERE SELECTED BY FBI AND

UNITED STATES SECRET SERVICE (USSS), LOS ANGELES, FOR INTER-
VIEWS REGARDING CAPTIONED MATTER; [redacted]

REC-81

b3
b6
b7C
b7E

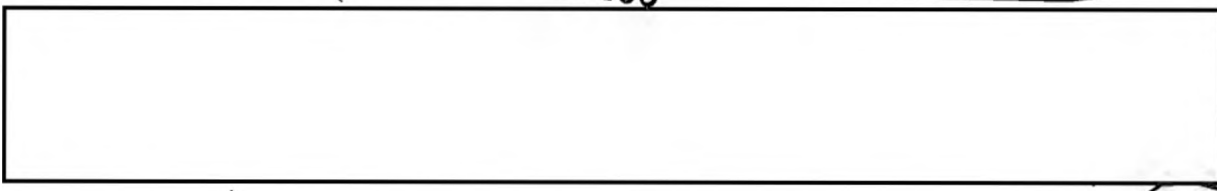

OCT 15 1979

b6
b7C

04 OCT 1979

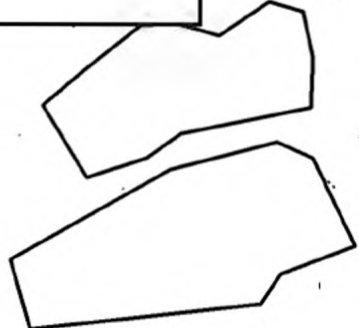
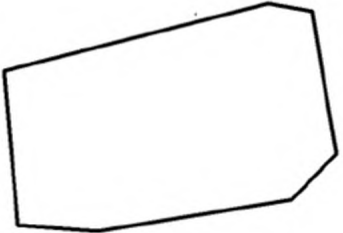

JOINT INVESTIGATION BY VSSS AND FBI TO LOCATE THE ABOVE

SUBJECTS WAS NEGATIVE WITH THE EXCEPTION OF [REDACTED]

[REDACTED]. ON 10/10/79, [REDACTED] STATED THAT HE WOULD TRAVEL TO NEW YORK ON OCTOBER 11, 1979 ON UNITED AIRLINES FLIGHT 4, ARRIVING IN NEWARK, NEW JERSEY. [REDACTED]

FURTHER STATED THAT HE WOULD MEET IN NEW JERSEY WITH [REDACTED]

[REDACTED] AN ANTI-CASTRO GROUP CALLED "BLOQUE DE ORGANIZACION REVOLUCIONARIES DE NEW JERSEY". [REDACTED]

[REDACTED] STATED THAT HIS PURPOSE IN TRAVELING TO NEW JERSEY WAS TO STOP ANY VIOLENT ACTIVITIES WHICH ANTI-CASTRO GROUPS THERE MIGHT BE PLANNING AND THAT HE WOULD BE IN THE NEW YORK AREA DURING CASTRO'S STAY THERE.

ON OCTOBER 9, 1979, USSS AGENT [REDACTED] ADVISED FBI LOS ANGELES THAT HIS AGENCY HAS CLOSED ITS INVESTIGATION REGARDING THIS MATTER IN THE LOS ANGELES AREA AND THAT NO FURTHER INVESTIGATION IS CONTEMPLATED BY THEM HERE.

ON OCTOBER 10, 1979, FBI LOS ANGELES CONTACTED THE LOS ANGELES POLICE DEPARTMENT AND DETERMINED THAT THEIR SOURCE WOULD NOT BE TRAVELING TO NEW YORK AND THAT, FURTHERMORE, THEIR SOURCE COULD PROVIDE NO NEW INFORMATION CONCERNING

b3
b6
b7C
b7E

b6
b7C

b6
b7C

PAGE THREE (LA 185-273) ~~SECRET~~

THIS MATTER.

FBI LOS ANGELES CONTINUES TO MAINTAIN CONTACT WITH SOURCES, USSS, AND THE LOS ANGELES POLICE DEPARTMENT ON A DAILY BASIS FOR POSITIVE INTELLIGENCE IN THIS AREA.

C AND E 7891, REASON (2), DRD OCTOBER 10, 1999.

BT

#



RECEIVED
TELETYPE UNIT

17 OCT 79 12 33z

RECEIVED
FEDERAL BUREAU
OF INVESTIGATION
COMMUNICATIONS SECTION

Exec. AD-Inv.	_____
Exec. AD-Adm.	_____
Exec. AD-LES	_____
Asst. Dir.:	
Adm. Servs.	_____
Crim. Inv.	_____
Ident.	_____
Intell.	_____
Laboratory	_____
Legal Coun.	_____
Plan. & Insp.	_____
Rec. Mgmt.	_____
Tech. Servs.	_____
Training	_____
Public Affs. Off.	_____
Telephone Rm.	_____
Director's Sec'y	_____

b6
b7C

SJ0335 2850223Z

RR HI CG LA MM NK NY SF WF

DE SJ

R 1124Z OCT 79

FM SAN JUAN (185-70) (P)

TO DIRECTOR ROUTINE

ATTN: CRIMINAL INVESTIGATION DIVISION AND INTELLIGENCE

DIVISION, CI-2 UNIT

CHICAGO ROUTINE

LOS ANGELES ROUTINE

MIAMI ROUTINE

NEWARK ROUTINE

NEW YORK ROUTINE

SAN FRANCISCO ROUTINE

WASHINGTON FIELD ROUTINE

BT

UNCLAS E F T O

CAZVIZ; PFO; (OO: NEW YORK)

REFERENCE SAN JUAN TELETYPE TO DIRECTOR, DATED OCTOBER 10, 1979

1979, ENTITLED "CAZVIZ".

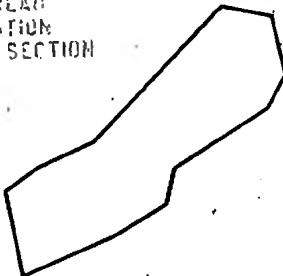

✓ CI-2



b6
b7C



185-1241-88

EX-125

REC-65

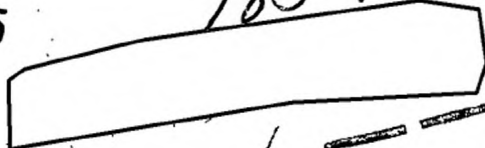

b3
b6
b7C
b7E



TELETYPE ID:



b6
b7C

PAGE TWO (185-70) UNCLAS E F T O

JOINT INTERVIEWS CONTINUE TO BE CONDUCTED BY FBI, SAN JUAN, AND U.S. SECRET SERVICE, SAN JUAN, OF KNOWN ACTIVE AND INACTIVE ANTI-CASTRO CUBAN EXILES.

ON OCTOBER 11, 1979, IN RESPONSE TO A REQUEST LEFT AT HIS HOME, [REDACTED] APPEARED AT THE SAN JUAN, FBI OFFICE, AND WAS INTERVIEWED BY A TEAM OF FBI AND SECRET SERVICE AGENTS.

b6
b7C

[REDACTED] DENIED BEING INVOLVED IN ANY PLANS OR HAVING KNOWLEDGE OF ANY PLANS TO DISRUPT THE VISIT OF FIDEL CASTRO TO THE UNITED STATES.

b6
b7C

[REDACTED] IS DESCRIBED AS BEING A WHITE MALE; 5'10"; 180 POUNDS; BLACK HAIR; BROWN EYES; PUERTO RICO DRIVER'S LICENSE NO. [REDACTED] SSAN [REDACTED] RESIDENCE, [REDACTED]

b6
b7C

[REDACTED]

THE BELOW LISTED INDIVIDUALS HAVE YET TO RESPOND TO REQUESTS LEFT AT THEIR PLACES OF RESIDENCE TO CONTACT EITHER THE FBI OFFICE, SAN JUAN OR THE OFFICE OF THE U.S. SECRET SERVICE, SAN JUAN:

PAGE THREE (185-70) UNCLAS E F T O



b6
b7C

SAN JUAN IS CONTINUING IN ITS ATTEMPTS TO LOCATE AND
INTERVIEW ABOVE INDIVIDUALS.

BT

CC-01-2

b6
b7c

NY00318 2850316
PP HQ CG MM NK SF HI WF
DE NY 0024
P110055Z OCT 79
FM NEW YORK (185-899) (M-10)
TO DIRECTOR PRIORITY
CHICAGO PRIORITY
MIAMI PRIORITY
NEWARK PRIORITY
SAN FRANCISCO PRIORITY
SAN JUAN PRIORITY (VA FBIHQ)
WASHINGTON FIELD PRIORITY
BT

RECEIVED
TELETYPE UNIT
[redacted]
17 OCT 79 03 51 z
RECEIVED
FEDERAL BUREAU
OF INVESTIGATION
COMMUNICATIONS SECTION

Exec. AD-Inv.	_____
Exec. AD-Adm.	_____
Exec. AD-LES	_____
Asst. Dir.:	
Adm. Serv.	[redacted]
Crim. Inv.	[redacted]
Ident.	_____
Intell.	_____
Laboratory	_____
Legal Coun.	_____
Plan. & Insp.	_____
Rec. Mgnt.	_____
Tech. Servs.	_____
Training	_____
Public Affs. Off.	_____
Telephone Rm.	_____
Director's Sec'y	_____

~~CONFIDENTIAL~~

SECTION ONE OF THREE SECTIONS

CAZVIZ; PFO; OO: NEW YORK.

REFERENCED MADE TO NEW YORK TELETYPES, DATED OCTOBER 10,
1979 AND NEW YORK TELEPHONE [redacted] TO THE BUREAU, OCTOBER 11,
1979. *EX-125* *185-1241-89*

REC-65

[redacted]

b6
b7c

b3
b7E

THE FOLLOWING IS SUMMARY OF INVESTIGATION AND INFORMATION RELATIVE TO THIS CASE:

FOR INFORMATION OF RECEIVING OFFICES OTHER THAN CHICAGO AND SAN FRANCISCO, ON THE EVENING OF OCTOBER 10, 1979,

OCT 16 1979
[redacted]

b6
b7c

60 [redacted]

[REDACTED] WERE

b6
b7C

INTERVIEWED AT NEW YORK CITY BY UNITED STATES SECRET SERVICE (USSS) SPECIAL AGENT, UNITED STATES STATE DEPARTMENT SPECIAL AGENT AND SPECIAL AGENT OF FBI, NYO, FAMILIAR WITH CUBAN EXILE ACTIVITIES.

IT IS THE OPINION OF FBI, NYO, AND USSS THAT THIS MATTER IS A MERE COINCIDENCE AND THAT BOTH OF THE ABOVE INDIVIDUALS ARE IN FACT LEGITIMATE PERSONS.

IN SUMMARY, [REDACTED] (PREVIOUSLY SHOWN AS [REDACTED]) STATED THAT HE IS AN ART DEALER BY TRADE AND THIS WAS CONFIRMED BY HIS BRITISH PASSPORT. [REDACTED] WAS TOTALLY COOPERATIVE DURING THE INTERVIEW AND ADMITTED TO OWNING AN AR 15 AND NUMEROUS OTHER WEAPONS. [REDACTED] HAS LEGITIMATE NEW YORK CITY GUN PERMIT FOR THESE WEAPONS AND THERE IS NO FEDERAL OR STATE VIOLATION IN [REDACTED] BEING IN POSSESSION OF THESE GUNS. [REDACTED] LIVES NEXT DOOR TO [REDACTED] AND MET [REDACTED] ON ONE OCCASION WHEN [REDACTED] MOVED INTO THE BUILDING APPROXIMATELY SIX TO SEVEN MONTHS AGO. [REDACTED] AND [REDACTED] INVITED [REDACTED] TO DINNER AND [REDACTED] COMPLIED. [REDACTED] HAS SPOKEN TO [REDACTED] ON A SOCIAL BASIS WHEN BOTH OF

b6
b7C

b6
b7C

b6
b7C

THEM MEET WHILE TRAVELING THROUGHOUT THE APARTMENT COMPLEX.

[REDACTED] HAS NO KNOWLEDGE OF ANY CUBAN EXILES IN THE UNITED STATES. [REDACTED] IS DESCRIBED AS A BRITISH CITIZEN, BRITISH PASSPORT NUMBER [REDACTED] DOB: [REDACTED]

b6
b7c

[REDACTED] HAS INS NUMBER [REDACTED] AND ENTERED THE UNITED STATES IN AUGUST, 1970. [REDACTED] STATED TO THE INTERVIEWING SPECIAL AGENTS THAT HE WOULD ALLOW ANY TYPE OF SEARCH OF HIS RESIDENCE WHICH WOULD BE REQUIRED AND THAT INTERVIEWING SPECIAL AGENTS HAD HIS FULL CONSENT.

[REDACTED] SUBSEQUENTLY INTERVIEWED AT HIS APARTMENT NEXT DOOR TO [REDACTED] WHEREIN [REDACTED] STATES THAT HE IS CURRENTLY DOING AN ARTICLE [REDACTED] RELATIVE TO THE VISIT OF FIDEL CASTRO TO THE UNITED STATES AND ADDITIONALLY RELATIVE TO GENERAL PRO-CUBAN AND CUBAN EXILE ACTIVITY HERE IN THE UNITED STATES. [REDACTED] STATED THAT HE IS ALSO THE

b6
b7c

[REDACTED]
[REDACTED] AND THAT HIS STORY RELATIVE TO CUBA AND CUBAN EXILES WILL ALSO APPEAR IN THAT NEWSPAPER. [REDACTED] WAS TOTALLY COOPERATIVE DURING INTERVIEW AND STATED THAT INTERVIEWING SPECIAL AGENTS COULD CONDUCT ANY TYPE OF SEARCH WHICH WOULD

BE NECESSARY TO RESOLVE THIS MATTER.

RELATIVE TO HIS RELATION WITH ANDRES NASARIO SARGEN,

[] STATED THAT HE IS, AS A RESULT OF BEING A PRIOR
RESIDENT OF [] ACQUAINTED WITH A CUBAN
EXILE THERE WHOSE NAME IS [] A MEMBER OF ALPHA 66
IN CALIFORNIA.

b6
b7C

ACCORDING TO [] AS A RESULT OF HIM BEING ASSIGNED
THE ABOVE TYPE ARTICLE, HE CONTACTED [] TELEPHONICALLY
IN CALIFORNIA AND ASKED [] HOW HE COULD GET IN TOUCH WITH
ALPHA 66 LEADER, NASARIO SARGEN FOR ASSISTANCE IN HIS ARTICLE.

b6
b7C

[] TOLD [] THAT HE WAS NOT POSITIVE HOW TO GET IN TOUCH
WITH SARGEN BUT [] PROVIDED THE TELEPHONE NUMBER OF []
[], TELEPHONE [] AS BEING AN INDIVIDUAL WHO
MAY KNOW HOW TO CONTACT SARGEN. [] STATED THAT SHOULD THIS
NOT SUCCEED, [] STATED THAT [] TELEPHONE NUMBER

b6
b7C

[] MAY BE ABLE TO ASSIST [] ALSO. ADDITIONALLY,
[] STATED THAT SHOULD THIS NOT SUCCEED [] COULD CONTACT
A [] (FNU) [] TELEPHONE [] WHO COULD PROVIDE
ASSISTANCE IN LOCATING SARGEN. [] STATED HE CALLED []

b6
b7C

[] TOLD HIM THAT SARGEN WAS CURRENTLY IN THE NEW

PAGE FIVE ~~CONFIDENTIAL~~

YORK AREA. [] REQUESTED INTERVIEW WITH SARGEN, SARGEN AGREED, AND SARGEN SUBSEQUENTLY APPEARED AT [] RESIDENCE WITH [] STATED THAT HE WAS WILLING TO PROVIDE THE FBI WITH ANY INFORMATION DISCUSSED HOWEVER IT WAS GENERAL IN NATURE RELATIVE TO THE HISTORY OF CUBA AND THE HISTORY OF CUBAN EXILES. [] STATED THAT THE SESSION LASTED APPROXIMATELY THREE TO FOUR HOURS AND THAT SARGEN MADE NO COMMENTS RELATIVE TO ANY UPCOMING VIOLENCE.

b6
b7C

[] STATED THAT IN ESSENCE, THE INTERVIEW IN HIS OPINION WAS A FLOP SINCE SARGEN REALLY DID NOT TELL [] ANYTHING HE DID NOT ALREADY KNOW.

b6
b7C

[] INDEPENDENTLY STATED THAT HE HAS MET [] ONLY ON REALLY ONE OCCASION AND THAT OCCASION WAS WHEN [] HAD DINNER WITH [] WHEN [] INITIALLY ARRIVED AND MOVED INTO THE APARTMENT COMPLEX.

b6
b7C

[] IS DESCRIBED AS A WHITE MALE, DOB: [] AT [] UNITED STATES PASSPORT NUMBER []

USSS AND NYO, FBI, AS A RESULT OF INTERVIEWS, BELIEVE THERE IS NO THREAT POTENTIAL IN THIS MATTER AND NO FURTHER INVESTIGATION IS BEING CONDUCTED RELATIVE TO []

b6
b7C

AT THIS TIME.

FOR THE INFORMATION OF RECIPIENT OFFICES, ESPECIALLY NEWARK DIVISION, NYCPD INTELLIGENCE OFFICIALS HAVE ADVISED THAT ON OCTOBER 5, 1979, A 1973 GREEN PLYMOUTH, [REDACTED] WAS TAKEN FROM A POLICE GARAGE. THIS IS A POLICE VEHICLE BELONGING TO NYCPD AND HAS A RADIO WHICH HAS AVAILABLE TRAFFIC FREQUENCIES. NYCPD HAS SET OUT AN APPROPRIATE ALARM ON THIS VEHICLE.

DURING EARLY MORNING HOURS OF OCTOBER 11, 1979, PREMIER FIDEL CASTRO ARRIVED AT NEW YORK CITY AND WAS SUBSEQUENTLY ESCORTED BY MOTORCADE TO THE CUBAN MISSION TO THE UNITED NATIONS (CMUN), NOW LOCATED AT EAST 38TH STREET AND LEXINGTON AVENUE, NEW YORK CITY. TWO SPECIAL AGENTS OF NYO FAMILIAR WITH CUBAN EXILE ACTIVITY WERE AVAILABLE FOR ASSISTANCE AND UPON ARRIVAL AT CMUN A SMALL CROWD OF CUBAN EXILES, HOLDING PLACARDS INDICATING THEY MAY BE FROM ALPHA 66 GROUP, WERE PRESENT APPROXIMATELY ONE BLOCK AWAY. OBSERVATION OF GROUP REVEALED THAT THOSE RECOGNIZED WERE ANDRES SARGEN, ALPHA 66 LEADER OF MIAMI, AND ALSO [REDACTED]

[REDACTED] THESE

b6
b7c

b6
b7c

NY00319 2850330

PP HQ CG MM NK SF HI WF

DE NY 0025

P110103Z OCT 79

FM NEW YORK (185-899) (M-10)

TO DIRECTOR PRIORITY

CHICAGO PRIORITY

MIAMI PRIORITY

NEWARK PRIORITY

SAN FRANCISCO PRIORITY

SAN JUAN PRIORITY (VA FBIHQ)

WASHINGTON FIELD PRIORITY

BT

~~C O N F I D E N T I A L~~

SECOND SECTION OF THREE SECTIONS

CAZVIZ; PFO; .99: NEW YORK.

INDIVIDUALS WERE PHYSICALLY POINTED OUT TO AGENTS OF STATE DEPARTMENT AND USSS BY NYO SPECIAL AGENTS. APPROXIMATELY THIRTY ADDITIONAL CUBAN EXILES, MOST OF THEM ELDERLY IN AGE, WERE PRESENT AT RALLY INCLUDING [REDACTED] WHO APPEARS TO BE CLOSE ASSOCIATE OF [REDACTED]

[REDACTED] IT IS NOTED THAT [REDACTED]

b6
b7C
b7E

PAGE TWO ~~CONFIDENTIAL~~

SUBSEQUENT TO ARRIVAL OF FIDEL CASTRO, NUMEROUS MEMBERS OF HIS SECURITY FORCE WHO WERE APPARENTLY PARKED AWAY FROM THE CMUN APPEARED ON LEXINGTON AVENUE HEADING FOR THE CMUN. ONE OF THESE INDIVIDUALS WAS OBVIOUSLY CARRYING A RIFLE OF SOME TYPE, HOWEVER, THE WOODEN STOCK WAS SHOWING AND IT WAS OBVIOUS THAT THE CUBAN KNEW THIS. THIS OBSERVATION BY CUBAN EXILES OBVIOUSLY PROVOKED THE GROUP AND THEY BROKE FROM THE POLICE LINE AND APPROACHED THE CUBAN SECURITY FORCE. THEY WERE SUBSEQUENTLY MOVED BACK BY NYCPD PERSONNEL.

SHORTLY SUBSEQUENT TO THAT SITUATION, A SECOND GROUP OF CUBAN SECURITY PERSONNEL BEGAN APPROACHING THE AREA, HOWEVER, THIS TIME ON THE SAME SIDE OF THE STREET AS WHERE THE ALPHA 66 DEMONSTRATORS WERE LOCATED. FROM OBSERVATION THERE WERE APPROXIMATELY FOUR TO SIX CUBAN SECURITY PERSONNEL IN THE GROUP AND THEY SUBSEQUENTLY WALKED PURPOSLY DIRECTLY THROUGH THE ALPHA 66 DEMONSTRATION CROWD. AT THAT POINT CUBAN EXILES AND SECURITY PERSONNEL BEGAN EXCHANGING HARSH WORDS AND AN INCIDENT STARTED BETWEEN AN UNKNOWN EXILE AND A MEMBER OF THE SECURITY FORCE. THE INCIDENT CAUSED PANIC AMONG BOTH GROUPS AND A FIGHT BROKE OUT AT WHICH POINT AN UNKNOWN MEMBER

OF THE SECURITY PERSONNEL DREW A HANDGUN FROM HIS BELT WHEREIN IT WAS ALLEGEDLY IMMEDIATELY TAKEN BY NYCPD OFFICER. ACCORDING TO THE NYCPD THE GUN WAS IN A COCKED POSITION. THE SECURITY WAS DETAINED MOMENTARILY AND THE GUN WAS TURNED OVER TO THE CMUN AND THE SECURITY OFFICER RELEASED.

THIS SITUATION HAS INFLAMED THE CUBAN EXILES WHO WERE PRESENT AT THAT TIME AND IT IS NOTED THAT IT HAS BEEN WIDELY RUMORED THROUGHOUT THE CUBAN EXILE COMMUNITY THAT CASTRO'S SECURITY FORCE WOULD BE CARRYING WEAPONS. HOWEVER, THE CUBAN EXILES, UNTIL THIS POINT, HAS NEVER SEEN CASTRO'S SECURITY PERSONNEL WITH ACTUAL WEAPONS IN THEIR HANDS AND SUBSEQUENT TO THE ABOVE INCIDENT, THE EXILES BEGAN ASKING AGENT PERSONNEL AND NYCPD PERSONNEL WHY CASTRO'S PEOPLE WERE ALLOWED TO CARRY WEAPONS IN THE UNITED STATES.

AT THIS TIME, [REDACTED] HIGHLY RELIABLE, IS ADVISING THAT [REDACTED]

b7D

[REDACTED]

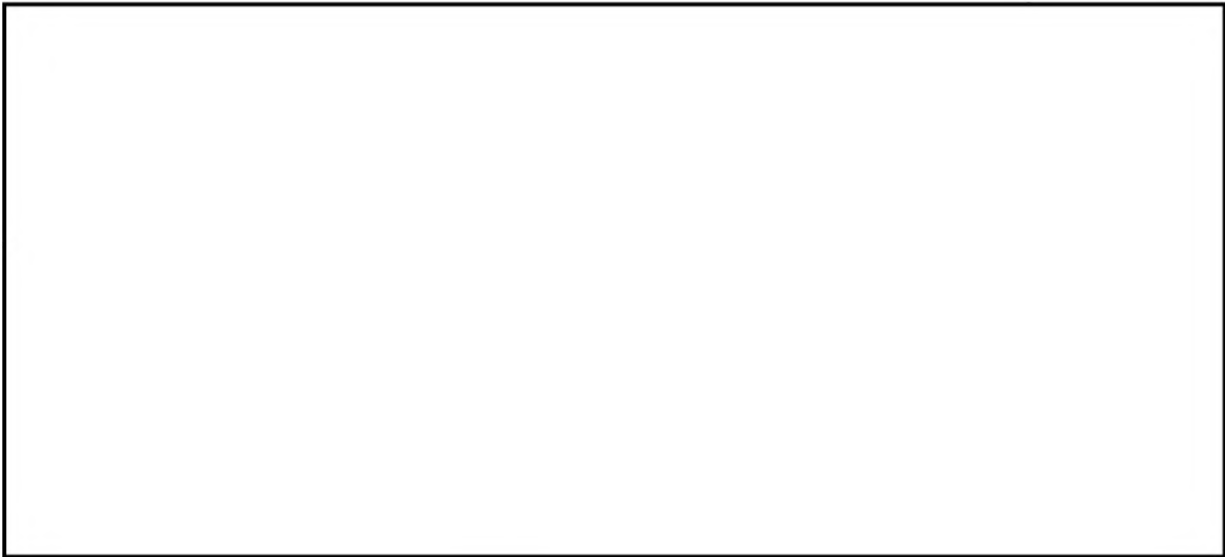

b7D



b7D

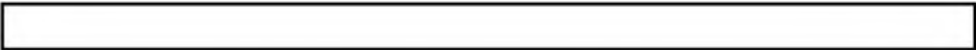

THE ABOVE

INFORMATION FROM NYO SOURCE WAS IMMEDIATELY DISSEMINATED TO
USSS, UNITED STATES STATE DEPARTMENT AND NYCPD INTELLIGENCE
DIVISION.

ON OCTOBER 10, 1979, SPECIAL AGENTS FBI, USSS AND OFFICES

OF THE NYCPD INTERVIEWED [REDACTED] AT HIS RESIDENCE,

[REDACTED] RELATIVE TO THE ALLEGED PLOT TO ASSASSINATE FIDEL CASTRO.

b6
b7C

[REDACTED] DENIED ANY KNOWLEDGE OF A CONSPIRACY TO KILL CASTRO AND STATED THE IDEA TO BE A PROPOSTEROUS CONCOCTION OF SOME "WEIRDO".

IT WAS NOTED THAT [REDACTED] CLAIMS TO BE BLIND IN ONE EYE AND OBSERVATION OF HIS EYEGASSES INDICATED THAT HE HAS EXTREMELY POOR VISION.

b6
b7C

AT THE TIME OF THE CONTACT NO MENTION WAS MADE OF INFORMATION LINKING [REDACTED]

b6
b7C

[REDACTED] ON OCTOBER 11, 1979, ORAL CONSENT WAS OBTAINED FROM THE [REDACTED] AND A SEARCH FOR WEAPONS WAS CONDUCTED WITH NEGATIVE RESULTS.

b6
b7C

NYO FEELS THE INFORMATION RECEIVED FROM THE SUFFOLK COUNTY DISTRICT ATTORNEYS OFFICE SOURCE AS FURNISHED TO HIM BY [REDACTED] [REDACTED] WAS UNRELIABLE.

b6
b7C

ON OCTOBER 10, 1979, AGENTS OF THE NYO ALONG WITH AGENTS OF USSS LOCATED AND INTERVIEWED ANDRE NASARIO SARGEN AT

[REDACTED] SARGEN WAS TOLD THAT HIS

b6
b7c

ACTIONS REGARDING THE VISIT OF FIDEL CASTRO TO NEW YORK CITY WERE BEING CLOSELY MONITORED BY FEDERAL AUTHORITIES. SARGEN WAS ALSO INFORMED THAT IF ANY ATTEMPTS WERE MADE TO HARM CASTRO, HE WOULD BE A MAJOR SUSPECT.

SARGEN ADVISED THAT ALTHOUGH HE WOULD LIKE TO SEE CASTRO DEAD, HE WOULD NOT SPONSOR OR SUPPORT ANY SUCH ACTION. SARGEN STATED THAT TO HIS KNOWLEDGE, NO PLOTS EXIST TO HARM CASTRO DURING HIS NEW YORK STAY.

RELATIVE TO THE ITINERY OF CASTRO WHILE IN NEW YORK CITY AND THE LENGTH OF HIS STAY, USSS HAS ADVISED THAT THE EXACT ITINERARY AS OF YET NOT BEEN FURNISHED BY THE CMUN. IT IS KNOWN THAT CASTRO WILL ADDRESS THE GENERAL ASSEMBLY AT NOON, OCTOBER 12, 1979. CASTRO HAS BEEN INVITED TO SEVERAL RECEPTIONS OVER THE COMING WEEKEND AND ON MONDAY, OCTOBER 15, 1979. THEREFORE, IN ALL PROBABLY CASTRO WILL REMAIN IN NEW YORK CITY THROUGH OCTOBER 15, 1979.

[REDACTED]

b6
b7c
b7E

NY00320 2850344

PP HQ CG MM NK SF HI WF

DE NY 0026

P110111Z OCT 79

FM NEW YORK (185-899) (M-10)

TO DIRECTOR PRIORITY

CHICAGO PRIORITY

MIAMI PRIORITY

NEWARK PRIORITY

SAN FRANCISCO PRIORITY

SAN JUAN PRIORITY (VA FBIHQ)

WASHINGTON FIELD PRIORITY

BT

~~C O N F I D E N T I A L~~

SECTION THREE OF THREE SECTIONS

CAZVIZ; PFO; OO: NEW YORK.

ON OCTOBER 11, 1979, LIEUTENANT [REDACTED] UNITED NATIONS SECURITY FORCE, ADVISED THAT DURING THE EVENING HOURS OF OCTOBER 10, 1979, A LICENSE PLATE [REDACTED] WAS REPORTED STOLEN FROM A TRUCK ASSIGNED TO THE UNITED NATIONS. THE TRUCK WAS PARKED AT PIER 92, PORT NEWARK AT THE CHILEAN LINE. HE FURTHER ADVISED THAT ON SUNDAY, OCTOBER 7, 1979, A 1970 GRAY VOLVO BEARING [REDACTED] WAS STOLEN FROM IN FRONT OF THE RESIDENCE OF [REDACTED] [REDACTED] OFFICE OF PERSONNEL SERVICES, UNITED NATIONS. [REDACTED]

b6
b7c

Exec. AD-Inv.	
Exec. AD-Adm.	
Exec. AD-LES	
Asst. Dir.:	
Adm. Servs.	
Crim. Inv.	
Ident.	
Intell.	
Laboratory	
Legal Coun.	
Plan. & Insp.	
Rec. Mgnt.	
Tech. Servs.	
Training	
Public Affs. Off.	
Telephone Rm.	
Director's Sec'y	

b6
b7C

RECEIVED
TELETYPE UNIT
12 OCT 79 00 13z
RECEIVED
FEDERAL BUREAU
OF INVESTIGATION
COMMUNICATIONS SECTION

b6
b7C

CG0027 2842345
PP HI MM NK SJ WF LA SF
DE CG
P 112345Z OCT 79

FM CHICAGO (185-217)
TO DIRECTOR PRIORITY
MIAMI (185-126) PRIORITY
NEW YORK (185-899) PRIORITY
NEWARK PRIORITY
SAN JUAN PRIORITY
WFO PRIORITY
LOS ANGELES PRIORITY
SAN FRANCISCO PRIORITY
BT

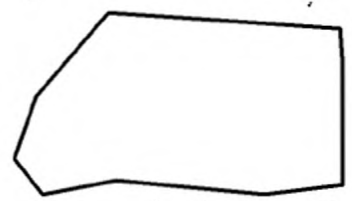

b3
b6
b7C
b7E

~~CONFIDENTIAL~~

CAZVIZ; PFO; OO: NEW YORK.

REC-65
EX-109

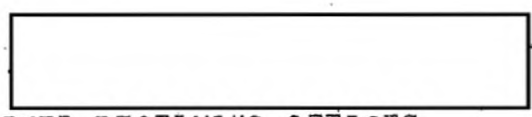

FOR INFORMATION OF THE BUREAU AND OTHER RECEIVING OFFICES,

[redacted] ON OCTOBER 11, 1979 ADVISED THAT NO NEW INFORMATION
HAD COME TO HIS ATTENTION REGARDING ANY ALLEGED PLOT TO KILL
CASTRO IN NEW YORK. SOURCE FEELS THAT THE [redacted]

185-1241-91

b6
b7C
b7D

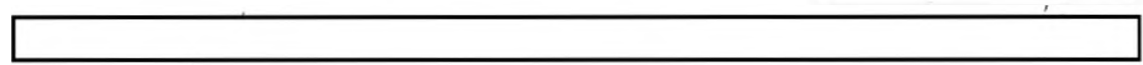

OCT 16 1979

b6
b7C

TELETYPED
6 1979



b7D

[REDACTED]

[REDACTED]

~~(S)~~ (U)

ON OCTOBER 10, 1979, [REDACTED] WAS TELEPHONICALLY ADVISED

BY [REDACTED]

b6
b7C
b7D

[REDACTED]

[REDACTED]

b7D

[REDACTED]

~~(S)~~ (U)

IF ANY PERTINENT INFORMATION IS OBTAINED BY [REDACTED] IT
WILL BE IMMEDIATELY FORWARDED TO NEW YORK. ~~(S)~~ (U)

~~C & F 1148, REASONS 2 & 3, DRD OCTOBER 11, 1999.~~

BT

WK 6-12

b6
b7C

O-73 (Rev. 10-26)

DECLASSIFICATION AUTHORITY DERIVED FROM:
FBI AUTOMATIC DECLASSIFICATION GUIDE
DATE 03-10-2023 BY: [redacted]

02

MESSAGE RELAY VIA TELETYPE

DATE 10/12/79	CLASSIFICATION SECRET	PRECEDENCE PRIORITY
------------------	-------------------------------------	------------------------

FM DIRECTOR FBI

TO FEDERAL GOVERNMENT

old page 3

b3
b6
b7C
b7E

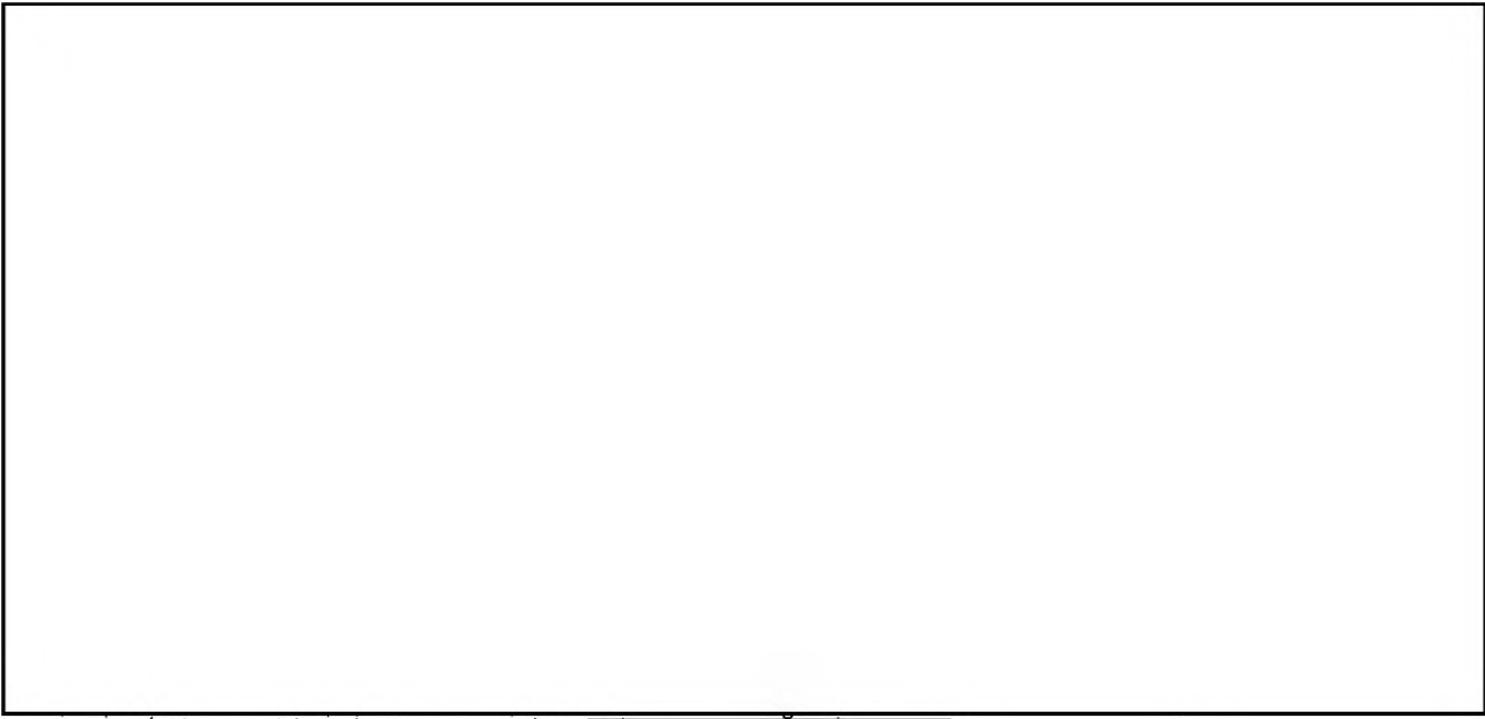

(SERVICE ALSO AVAILABLE TO GOVERNMENT AGENCIES NOT LISTED.
CONTACT COMMUNICATIONS CENTER FOR ADDRESSING INFORMATION)

185-1241-92

SUBJECT: VISIT OF PREMIER FIDEL CASTRO TO UN OCTOBER 19, 1979, PFO

REC-106

[redacted]

[redacted]

ORIGINATOR [redacted]	ROOM 5027	TELE EXT. 2805
--------------------------	--------------	-------------------

OCT 15 1979

b3
b6
b7C
b7E

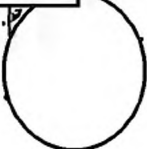

30 1979 FEDERAL BUREAU OF INVESTIGATION
COMMUNICATIONS SECTION
OCT 13 1979
0316

[redacted]

DO NOT FILE WITHOUT COMMUNICATIONS STAMP

FBI/DOJ

3

USE OF FORM 0-73

1. Only incoming teletype messages which require transmission relay may be prepared for transmission using form 0-73. Use of form 0-73 is restricted to incoming teletype messages received within the last 3 days which require transmission relay; all other teletype messages must be prepared using form 0-93.
2. Additions such as notes and administrative data for a specific addressee are not allowed. If a note or administrative data is required for a particular addressee a separate 0-73 form must be prepared.
3. The message will be transmitted just as it appears. The person approving the message is solely responsible for assuring all necessary editing changes have been made.

PREPARATION OF FORM WHICH CONSISTS OF A PREPRINTED YELLOW.

1. Complete appropriate boxes: date, classification & precedence.
2. List addresses immediately following the "TO" or place a check mark in the appropriate boxes.
3. Type or PRINT the subject in the space provided.
4. Print or type originator's name, room number and telephone extension.
5. Indicate approval for transmission by initialing the "Approved By" box.

RECEIVED
 FEDERAL BUREAU
 OF INVESTIGATION
 COMMUNICATIONS SECTION

13 OCT 79 00 24

PREPARATION OF MESSAGE TO BE TRANSMITTED

1. Xerox 1 copy of incoming teletype message. A notation shall be made on the original incoming teletype "1 copy made for relay to SACS _____, (OR LEGATS) _____, (OR GOVERNMENT AGENCIES) _____."
2. Minor editing changes shall be made on the xerox as follows: using a lead pencil ONLY draw single line through the first and last lines of the heading and connect these lines from top right to bottom left forming a "Z," figure. (DO NOT OBLITERATE THE HEADING.) Use horizontal lines to delete sentences or words. Printed changes of a word or two to the text of the message may be made; however, changes to the existing text involving more than a word or two necessitate the originator to initiate a new message using form 0-93.
3. Administrative data or notes may be typed immediately following the text and will be transmitted to all addressees.
4. When using the 0-73 form to disseminate information to field offices, Legal Attaches and other Government agencies simultaneously, the text, notes and administrative data must be identical for all addressees.

FEDERAL BUREAU OF INVESTIGATION
FOI/PA
DELETED PAGE INFORMATION SHEET
FOI/PA# 1362425-000

Total Deleted Page(s) = 71
Page 2 ~ b3; b6; b7C; b7E;
Page 3 ~ b3; b6; b7C; b7E;
Page 4 ~ b6; b7C;
Page 5 ~ b3; b6; b7C; b7E;
Page 6 ~ b6; b7C;
Page 7 ~ b6; b7C;
Page 9 ~ b6; b7C;
Page 12 ~ Duplicate;
Page 13 ~ Duplicate;
Page 18 ~ b3; b6; b7C; b7D; b7E;
Page 29 ~ b3; b6; b7C; b7E;
Page 30 ~ b3; b6; b7C; b7E;
Page 31 ~ b3; b6; b7C; b7E;
Page 32 ~ b3; b6; b7C; b7E;
Page 42 ~ Duplicate;
Page 43 ~ Duplicate;
Page 44 ~ Duplicate;
Page 45 ~ Duplicate;
Page 49 ~ b6; b7C; b7D;
Page 59 ~ Duplicate;
Page 60 ~ Duplicate;
Page 61 ~ Duplicate;
Page 62 ~ Duplicate;
Page 63 ~ Duplicate;
Page 64 ~ Duplicate;
Page 65 ~ Duplicate;
Page 66 ~ Duplicate;
Page 69 ~ Duplicate;
Page 76 ~ b3; b6; b7C; b7E;
Page 77 ~ b3; b6; b7C; b7E;
Page 78 ~ b3; b6; b7C; b7E;
Page 79 ~ b3; b6; b7C; b7E;
Page 80 ~ b3; b6; b7C; b7E;
Page 81 ~ b3; b6; b7C; b7E;
Page 82 ~ b3; b6; b7C; b7E;
Page 83 ~ b3; b6; b7C; b7E;
Page 84 ~ Referral/Direct;
Page 85 ~ Referral/Direct;
Page 93 ~ Duplicate;
Page 94 ~ Duplicate;
Page 95 ~ b3; b6; b7C; b7E;
Page 96 ~ b3; b6; b7C; b7E;
Page 97 ~ b3; b6; b7C; b7E;
Page 98 ~ b3; b6; b7C; b7E;
Page 99 ~ b3; b6; b7C; b7E;
Page 100 ~ b3; b6; b7C; b7E;
Page 111 ~ b3; b6; b7C; b7E;
Page 112 ~ b3; b6; b7C; b7E;
Page 113 ~ b3; b6; b7C; b7E;
Page 114 ~ b3; b6; b7C; b7E;
Page 115 ~ b3; b6; b7C; b7E;
Page 116 ~ b3; b6; b7C; b7E;
Page 117 ~ b3; b6; b7C; b7E;
Page 118 ~ b3; b6; b7C; b7E;
Page 119 ~ b3; b6; b7C; b7E;
Page 120 ~ b3; b6; b7C; b7E;
Page 128 ~ b3; b6; b7C; b7D; b7E;
Page 129 ~ b3; b6; b7C; b7D; b7E;
Page 131 ~ b3; b6; b7C; b7E;
Page 132 ~ b6; b7C; b7E;
Page 133 ~ b6; b7C; b7E;
Page 134 ~ b6; b7C; b7E;
Page 135 ~ b3; b6; b7C; b7E;
Page 136 ~ b6; b7C; b7E;
Page 137 ~ b6; b7C; b7E;
Page 138 ~ b6; b7C; b7E;
Page 139 ~ b6; b7C; b7E;

Page 140 ~ b6; b7C; b7E;
Page 141 ~ b6; b7C; b7E;
Page 142 ~ b6; b7C; b7E;
Page 143 ~ b6; b7C; b7E;

XXXXXXXXXXXXXXXXXXXXXXXXXXXX
X Deleted Page(s) X
X No Duplication Fee X
X For this Page X
XXXXXXXXXXXXXXXXXXXXXXXXXXXX

DECLASSIFICATION AUTHORITY DERIVED FROM:
FBI AUTOMATIC DECLASSIFICATION GUIDE
DATE 05-10-2023 BY: [redacted]
MESSAGE RELAY VIA TELETYPE

DATE 10/12/79	CLASSIFICATION SECRET	PRECEDENCE Priority
------------------	-------------------------------------	------------------------

FM DIRECTOR FBI

TO

FEDERAL GOVERNMENT

old page 3

b3
b6
b7C
b7E

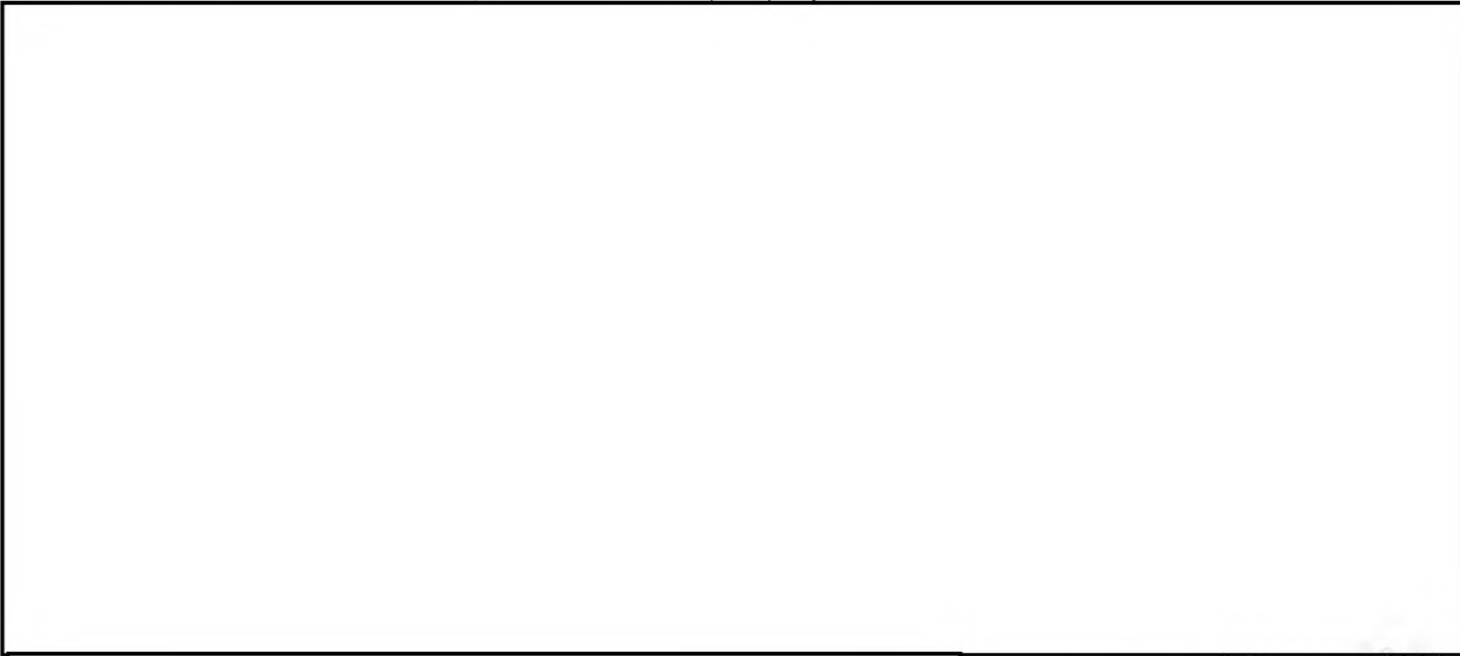

185-1241-94

(SERVICE ALSO AVAILABLE TO GOVERNMENT AGENCIES NOT LISTED. CONTACT COMMUNICATIONS CENTER FOR ADDRESSING INFORMATION)

SUBJECT:

EX-109
REC 11

OCT 16 1979

b3
b6
b7C
b7E

BY	ORIGINATOR	ROOM 4048	TELE EXT. 4660
----	------------	--------------	-------------------

FEDERAL BUREAU OF INVESTIGATION
COMMUNICATIONS SECTION

02317
OCT 13 1979

6 19

DO NOT FILE WITHOUT COMMUNICATIONS STAMP

2

USE OF FORM 0-73

1. Only incoming teletype messages which require transmission relay may be prepared for transmission using form 0-73. Use of form 0-73 is restricted to incoming teletype messages received within the last 3 days which require transmission relay; all other teletype messages must be prepared using form 0-93.
2. Additions such as notes and administrative data for a specific addressee are not allowed. If a note or administrative data is required for a particular addressee a separate 0-73 form must be prepared.
3. The message will be transmitted just as it appears. The person approving the message is solely responsible for assuring all necessary editing changes have been made.

PREPARATION OF FORM WHICH CONSISTS OF A PREPRINTED YELLOW.

1. Complete appropriate boxes: date, classification & precedence.
2. List addresses immediately following the "TO" or place a check mark in the appropriate boxes.
3. Type or PRINT the subject in the space provided.
4. Print or type originator's name, room number and telephone extension.
5. Indicate approval for transmission by initialing the "Approved By" box.

RECEIVED
FEDERAL BUREAU
OF INVESTIGATION
COMMUNICATIONS SECTION

20 OCT 19 21 08

PREPARATION OF MESSAGE TO BE TRANSMITTED

1. Xerox 1 copy of incoming teletype message. A notation shall be made on the original incoming teletype "1 copy made for relay to SACS _____, (OR LEGATS) _____, (OR GOVERNMENT AGENCIES) _____"
2. Minor editing changes shall be made on the xerox as follows: using a lead pencil ONLY draw single line through the first and last lines of the heading and connect these lines from top right to bottom left forming a "Z," figure. (DO NOT OBLITERATE THE HEADING.) Use horizontal lines to delete sentences or words. Printed changes of a word or two to the text of the message may be made; however, changes to the existing text involving more than a word or two necessitate the originator to initiate a new message using form 0-93.
3. Administrative data or notes may be typed immediately following the text and will be transmitted to all addressees.
4. When using the 0-73 form to disseminate information to field offices, Legal Attaches and other Government agencies simultaneously, the text, notes and administrative data must be identical for all addressees.

Exec. AD-Inv.	_____
Exec. AD-Adm.	_____
Exec. AD-LES	_____
Asst. Dir.:	
Adm. Servs.	_____
Crim. Inv.	_____
Ident.	_____
Intell.	_____
Laboratory	_____
Legal Coun.	_____
Plan. & Insp.	_____
Rec. Mgnt.	_____
Tech. Servs.	_____
Training	_____
Public Affs. Off.	_____
Telephone Rm.	_____
Director's Sec'y	_____

b6
b7C

NK0002 2851607

OO HI MM NY SJ

DE [redacted]

O 121307Z OCT 79

FM NEWARK (185-122) (P) (C-3)

TO DIRECTOR (IMMEDIATE)

MIAMI (185-126) (IMMEDIATE)

NEW YORK (185-899) (IMMEDIATE)

SAN JUAN (185-70) (IMMEDIATE)

BT

~~SECRET~~

CAZVIZ

CAZVIZ; PFO; OO: NEW YORK

RE: NEWARK TELCALL TO SA [redacted], MIAMI, OCTOBER 11,

1979.

ON OCTOBER 11, 1979, [redacted] ADVISED [redacted]

b6
b7C
b7D

[redacted]

REC-126 185-1297-93

SOURCE ADVISED [redacted]

OCT 17 1979

b6
b7C
b7D

[redacted]

SOURCE TOLD [redacted]

[redacted]

TELETYPE TO:

NOV 16 1979 [redacted]

b6
b7C

[REDACTED]

b6
b7C
b7D

SOURCE STATED [REDACTED]

[REDACTED]

FOR INFORMATION [REDACTED]

b6
b7C
b7D
b7E

[REDACTED]

IT IS FURTHER NOTED SOURCE WILL NOT COMPLY WITH

[REDACTED] REQUEST. SOURCE DID NOT REVEAL [REDACTED]

b3
b6
b7C
b7D
b7E

[REDACTED]

NEWARK HAS DISSEMINATED THE ABOVE TO USSS, NEWARK IN
A FASHION WHICH PROTECTS CONFIDENTIAL NATURE OF INFORMATION.

[REDACTED]

MIAMI, AT MIAMI, FLORIDA: ATTEMPT TO IDENTIFY

[REDACTED]

2. ASCERTAIN SUBSCRIBER TO [REDACTED]

NEWARK, AT NEWARK, NJ: WILL MAINTAIN CONTACT WITH

[REDACTED]

~~C&E 953, 2 & 3, OCTOBER 12, 1999~~

BT

b6
b7C
b7D
b7E

PP-HI MM NY

DE SJ 0001

P 122035Z OCT 79

17 OCT 79 20 527

FM SAN JUAN [redacted] (185-70)

TO DIRECTOR [redacted] PRIORITY

ATTN: INTELLIGENCE DIVISION, CI-2 UNIT, CRIMINAL
INVESTIGATIVE DIVISION

MIAMI PRIORITY

NEW YORK PRIORITY

BT

~~SECRET~~

[redacted], (OO: SAN JUAN)

CAZVIZ: PFO, (OO: NEW YORK)

REFERENCE SAN JUAN TELETYPE, OCTOBER 10, 1979.

THIS TELETYPE IS CLASSIFIED "~~SECRET~~" IN ITS ENTIRETY.

FOR THE INFORMATION OF THE BUREAU, [redacted]

[redacted]

b3
b6
b7C
b7E

Exec AD-Inv.	_____
Exec AD-Adm.	_____
Exec AD-LES	_____
Asst. Dir.:	
Adm. Servs.	_____
Crim. Inv.	_____
Ident.	_____
Insp.	_____
Intell.	_____
Legal Coun.	_____
Plan. & Insp.	_____
Rec. Mgmt.	_____
Tech. Servs.	_____
Training	_____
Public Affs. Off.	_____
Telephone Rm.	_____
Director's Sec'y	_____

b6
b7C

[redacted]

2

b3
b7E

b3
b6
b7C
b7D
b7E

[redacted]

185-1241-

[redacted]

NOT RECORDED
14 OCT 17 1979

b3
b6
b7C
b7E

TELETYPE

A.L.

97 OCT 29

[redacted]

ORIGINAL FILED IN

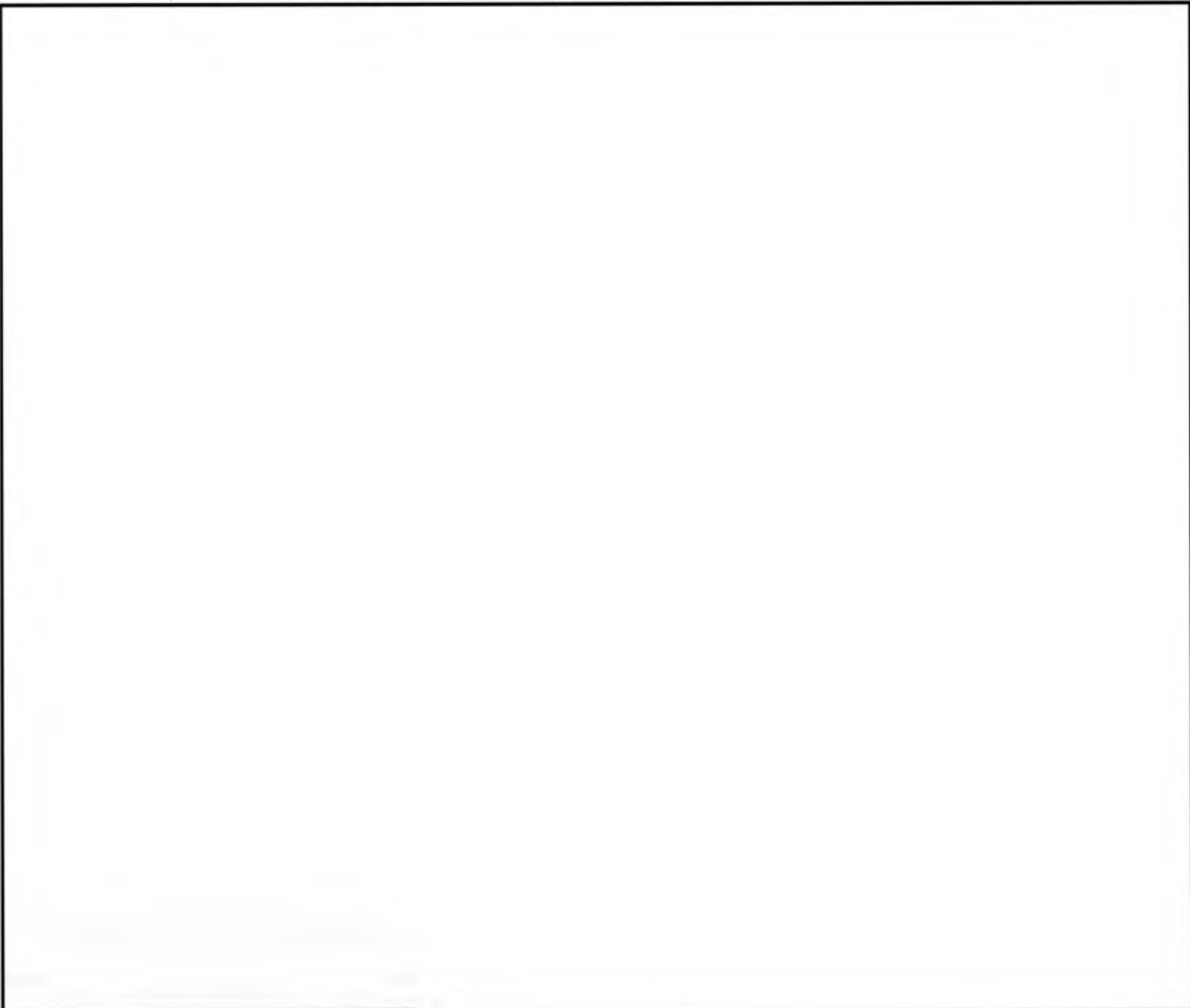

b3
b6
b7C
b7D
b7E



WILL BE EXPEDITIOUSLY REPORTED.

~~C AND E, 8024, REASON (D) AND (S), DRD OCTOBER 12, 1999.~~

BT

DC-10



BY: [redacted]

ST

Exec. AD-Inv.	
Exec. AD-Adm.	
Exec. AD-LES	
Asst. Dir.:	
Adm. Serv.	
Crim. Inv.	
Ident.	
Intell.	
Laboratory	
Legal Coun.	
Plan. & Insp.	
Rec. Mgmt.	
Tech. Servs.	
Training	
Public Affs. Off.	
Telephone Rm.	
Director's Sec'y	

b6
b7C

RECEIVED
TELETYPE UNIT

13 OCT 79 17 55 z

RECEIVED
FEDERAL BUREAU
OF INVESTIGATION
COMMUNICATIONS SECTION

MM0017 2861747
RR HI NY NK SJ
DE MM
R 131747Z OCT 79
FM MIAMI (185-126) P
TO DIRECTOR ROUTINE
NEW YORK (185-899) ROUTINE
NEWARK (185-122) ROUTINE
SAN JUAN (VIA WASHINGTON) (185-70) ROUTINE

BT

~~SECRET~~

CAZVIZ; PFO; OO: NEW YORK.

RE NEWARK TELETYPE TO THE BUREAU, OCTOBER 12, 1979.

ON OCTOBER 12, 1979, [redacted]

[redacted] TELEPHONE [redacted] WAS INTERVIEWED

BY SA [redacted] USSS AND SA [redacted] FBI

185-1241-96

[redacted] ADVISED HE IS A MEMBER OF FRANK PAIS, AN ANTI-

EX-125 REC-65

CASTRO ORGANIZATION. HE OR ANY OF HIS ASSOCIATES ARE NOT

PLANNING TO TRAVEL TO NEW YORK OR DEMONSTRATE IN MIAMI AGAINST

OCT 15 1979

FIDEL CASTRO. HE SAID HE IS NOT INVOLVED IN A PLOT TO KILL

CASTRO AND IS NOT AWARE OF ANYONE ELSE WHO IS PLANNING TO

b6
b7C

b3
b6
b7C
b7E

b6
b7C

TELETYPE

[redacted]
OCT 26 1979

[redacted]

ASSASSINATE HIM.

[REDACTED] STATED THERE ARE MANY CUBAN EXILES WHO HATE CASTRO AND IT WOULD BE LOGICAL TO EXPECT THAT SOMEONE HAS A PLAN TO KILL HIM. HE SAID THOSE WHO PLAN TO TAKE ACTION AGAINST CASTRO WILL DO IT WITH THE UTMOST CARE.

b6
b7C

MIAMI TELEPHONE NUMBER [REDACTED] IS LISTED TO [REDACTED]

b6
b7C

[REDACTED]
ON OCTOBER 13, 1979, SPOT CHECKS AT THAT LOCATION DURING THE DAY REVEALED FOLLOWING VEHICLES PARKED IN LOCATION WHICH IS AN INDUSTRIAL AREA:

1968 CHEVROLET STATION WAGON, [REDACTED]

b6
b7C

LATE MODEL CHEVROLET MONTE CARLO, [REDACTED]

[REDACTED] 1979 FORD MUSTANG, [REDACTED]

DODGE

STATION WAGON, YEAR UNKNOWN, [REDACTED]

ABOVE CHEVROLET STATION WAGON REGISTERED TO [REDACTED]

b6
b7C

[REDACTED] NO REGISTRATION INFO

PRESENTLY AVAILABLE ON OTHER VEHICLES. MIAMI INDICES NEGATIVE

ON [REDACTED]

~~C&E BY 6034, REASONS 2 & 3, DRD OCTOBER 13, 1999.~~

BT

#

Exec. AD-Inv.	_____
Exec. AD-Adm.	_____
Exec. AD-LES	_____
Asst. Dir.:	
Adm. Serv.	_____
Crim. Inv.	_____
Ident.	_____
Intell.	_____
Laboratory	_____
Legal Coun.	_____
Plan. & Insp.	_____
Rec. Mgnt.	_____
Tech. Servs.	_____
Training	_____
Public Affs. Off.	_____
Telephone Rm.	_____
Director's Sec'y	_____

b6
b7C

RECEIVED
TELETYPE UNIT

13 OCT 79 00 19z

RECEIVED 7:00 9z
FEDERAL BUREAU
OF INVESTIGATION
COMMUNICATIONS SECTION

MM0010 2860006Z [redacted]

PP HI NK NY SJ WF [redacted]

DE MM [redacted]

P 120006Z OCT 79

FROM MIAMI (185-126) P

TO DIRECTOR PRIORITY

NEWARK (185-122) (C-3) PRIORITY

NEW YORK (185-899) PRIORITY

SAN JUAN (185-70) (VIA WASHINGTON) PRIORITY

WASHINGTON FIELD PRIORITY

BT

~~CONFIDENTIAL~~

CAZVIZ. PFO. OO: NEW YORK.

RE NEWARK TELETYPE TO MIAMI, OCTOBER 11, 1979, AND MIAMI
TELETYPE, OCTOBER 11, 1979.

REGARDING INFORMATION FROM A NEWARK SOURCE [redacted]

b3
b6
b7C
b7D
b7E

[redacted]

[redacted] EX-109 REC-65 [redacted]

ON OCTOBER 12, 1979, [redacted]

185-1241-97

[redacted]

15 OCT 15 1979

b6
b7C

TELETYPED

25 1979

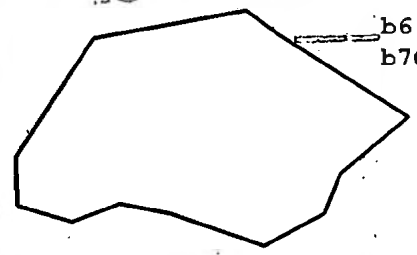

[REDACTED] ALL BUT TWO OF THESE PERSONS WERE INTERVIEWED BY USSS AND
FBI DURING PAST WEEK, ARE KNOWN TO BE IN MIAMI, [REDACTED]

b6
b7C
b7D

[REDACTED] THE TWO WHO HAVE NOT BEEN INTERVIEWED ARE

[REDACTED] HOWEVER, [REDACTED]

AND EFFORTS ARE BEING MADE TO LOCATE [REDACTED]

ON OCTOBER 12, 1979, [REDACTED] ADVISED THAT [REDACTED]

b6
b7C
b7D

[REDACTED] AND THAT [REDACTED] IS DEFINITELY

NOT INVOLVED IN ANY PLOT AGAINST FIDEL CASTRO.

ON OCTOBER 12, 1979, USSS, MIAMI, FURNISHED [REDACTED]

b7E

[REDACTED] USSS ADVISED THAT COPIES OF THIS DOCUMENT
HAVE BEEN FURNISHED TO FBI, NEW YORK AND FBIHQ BY USSS.

ONLY THE ITEMS PERTAINING TO MIAMI WILL BE ANSWERED IN THIS
TELETYPE.

REGARDING [REDACTED] THIS PERSON IS UNKNOWN TO FBI, MIAMI,
AND TO THE DADE COUNTY PUBLIC SAFETY DEPARTMENT. EMPLOYMENT
RECORDS OF DADE COUNTY WERE CHECKED WITH NEGATIVE RESULTS.

b6
b7C

REGARDING [REDACTED] HE HAS BEEN IN JAIL SINCE OCTOBER,
1975 [REDACTED]

PLOT TO KILL FIDEL CASTRO. HE DENIED ANY KNOWLEDGE OF THE LOCATION OF [REDACTED]

b6
b7C

REGARDING [REDACTED] HE HAS BEEN INTERVIEWED ON SEVERAL OCCASIONS BY THE FBI AND USSS. HE SAID HE WILL NOT BE TRAVELING TO NEW YORK. IT IS NOTED THAT [REDACTED]

b6
b7C
b7E

[REDACTED] NEITHER THE FBI IN MIAMI NOR THE DADE COUNTY PUBLIC SAFETY DEPARTMENT HAVE ANY INFORMATION REGARDING THIS MATTER.

THE MIAMI OFFICE WISHES TO POINT OUT THAT IT APPEARS THAT MUCH OF THE INFORMATION FURNISHED [REDACTED]

[REDACTED] APPEARS TO BE QUITE DATED AND INACCURATE.

b7E

INVESTIGATION CONTINUING AND MIAMI WILL KEEP THE BUREAU AND PERTINENT OFFICES ADVISED OF DEVELOPMENTS.

~~C & E BY 6034, REASONS 2 AND 3, DFD OCTOBER 12, 1999.~~

BT

#

Exec. AD-Inv.	b6
Exec. AD-Adm.	b7C
Exec. AD-LES	
Asst. Dir.:	
Adm. Servs.	
Crim. Inv.	
Ident.	
Intell.	
Laboratory	
Legal Coun.	
Plan. & Insp.	
Rec. Mgnt.	
Tech. Servs.	
Training	
Public Affs. Off.	
Telephone Rm.	
Director's Sec'y	

NK0014 - 2852330 [redacted]

RECEIVED
TELETYPE UNIT

RR HQ CG MM NY SF SJ

13 OCT 79 00 14z

DE NK [redacted]

RECEIVED
FEDERAL BUREAU
OF INVESTIGATION
COMMUNICATIONS SECTION [redacted]

R 122330Z OCT 79

FM NEWARK (185-122) (P) (C-3)

TO DIRECTOR (ROUTINE)

CHICAGO (ROUTINE)

MIAMI (ROUTINE)

NEW YORK (ROUTINE)

SAN FRANCISCO (ROUTINE)

SAN JUAN (VIA FBIHQ) (ROUTINE)

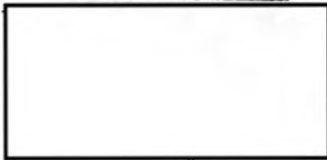

b6
b7C

BT

~~CONFIDENTIAL~~

CAZVIZ

PPF

00:NY)

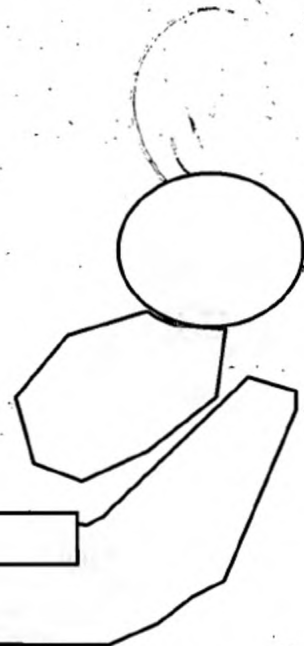

b3
b6
b7C
b7E

RE NEW YORK TELETYPE TO DIRECTOR, 10/11/79.

NEWARK INDICES CHECK RE [redacted] AND (FNU) [redacted]

NEGATIVE.

EX-125 REC-05

TELEPHONE SUBSCRIBER INFORMATION REVEALED THAT [redacted]

TELEPHONE NUMBER [redacted] (UNLISTED), RESIDES AT [redacted]

185-1241-98

[redacted]

15 1979

TELEPHONE NUMBER [redacted] RESIDES AT [redacted]

b6
b7C

[redacted]

TELETYPE T

CT 2 1979

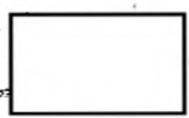

b6
b7C

PAGE TWO, NEWARK 185-122, ~~CONFIDENTIAL~~

[REDACTED] IS WIDELY KNOWN WITHIN THE CUBAN COMMUNITY BECAUSE OF HER AFFILIATION WITH ALPHA 66 [REDACTED] ANTI-CASTRO DEMONSTRATIONS.

b6
b7c

A REVIEW OF NEW JERSEY TELEPHONE DIRECTORY RE [REDACTED] UNCOVERED THAT HE FORMERLY RESIDED AT [REDACTED]

~~C & E 953, REASON 2 & 3, DRD OCTOBER 12, 1999.~~

BT

#

Exec. AD-Inv.	b6
Exec. AD-Adm.	b7C
Exec. AD-LES	
Asst. Dir.:	
Adm. Servs.	
Crim. Inv.	
Ident.	[redacted]
Intell.	
Laboratory	
Legal Coun.	
Plan. & Insp.	
Rec. Mgnt.	
Tech. Servs.	
Training	
Public Affs. Off.	
Telephone Rm.	
Director's Sec'y	

RECEIVED
TELETYPE UNIT

19 OCT 79 20 54z

RECEIVED
FEDERAL BUREAU
OF INVESTIGATION
COMMUNICATIONS SECTION

b3
b6
b7C
b7E

NY00400 2862030

RR HQ

DE NY 002

R132010Z OCT 79

FM NEW YORK

TO DIRECTOR ROUTINE

BT

FIRST SECTION OF TWO

~~SECRET~~

~~DE-28~~

VISIT OF FIDEL CASTRO TO THE UNITED STATES IN CONNECTION
WITH THE UNGA, OCTOBER, 1979, [redacted]

FOLLOWING INFORMATION WAS FURNISHED BY A HIGHLY
SENSITIVE CONFIDENTIAL SOURCE DURING THE PERIOD OF
OCTOBER 10, 1979, THROUGH OCTOBER 12, 1979. SOURCE

b3
b6
b7C
b7E

[redacted]
[redacted]

ON OCTOBER 10, 1979, SOURCE REPORTED THAT [redacted]

185-1241-979

b3
b6
b7C
b7E

[redacted]

OCT 16 1979

1cc to [redacted] USDS, USC em 0-73 10/15/79

b3
b6
b7C
b7E

64 NOV 1979

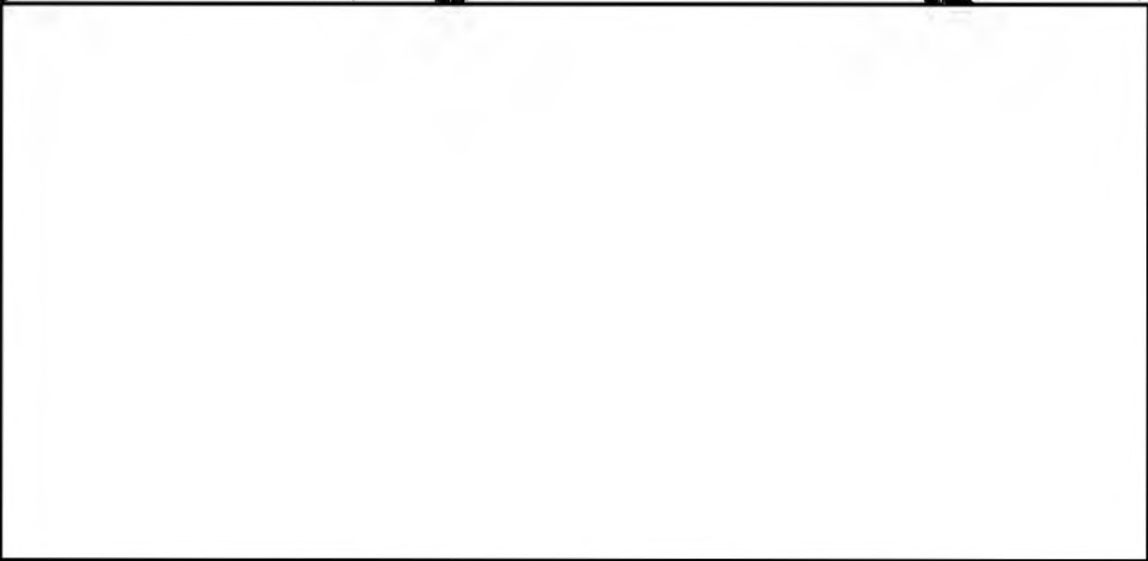

b3
b6
b7C
b7E



~~(S)~~ (U)

~~C AND E 3441, REASON 2 AND 3, DRD OCTOBER 13, 1999.~~

ADMINISTRATIVE

CONFIDENTIAL SOURCE IS  REGARDING

CONTACT BETWEEN  INFORMATION FROM OTHER SOURCES 

b3
b7D
b7E

FORMATION FROM OTHER SOURCES

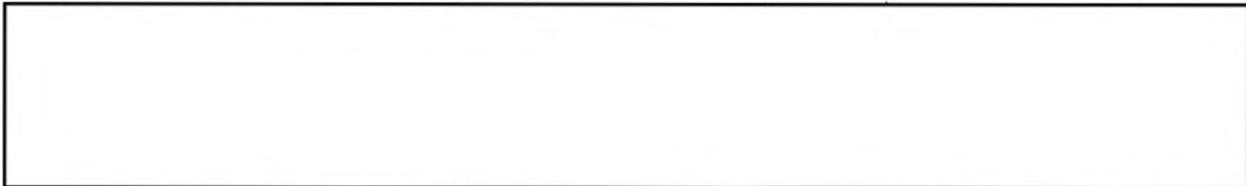

BT

NYO 2862045

b6
b7C

RR HQ

DE NY 0003

R132010Z OCT 79

FM NEW YORK

b3
b7E

TO DIRECTOR ROUTINE

BT

SECOND AND FINAL SECTION

~~SECRET~~

VISIT OF FIDEL CASTRO TO THE UNITED STATES IN CONNECTION
WITH THE UNGA, OCTOBER, 1979,

b3
b6
b7C
b7E

~~(S)~~ (U)

NYO IS CURRENTLY ATTEMPTING TO FURTHER IDENTIFY
(FNU) IN VIEW OF THE FACT THAT SOURCE INDICATED
THAT

~~(S)~~ (U)

ALTHOUGH SOURCE WAS UNABLE TO FURTHER IDENTIFY
(LNU), NYO FEELS THAT THIS INDIVIDUAL MAY BE
IDENTICAL TO

b6
b7C

~~(S)~~ (U)

LEAD

WASHINGTON FIELD

AT WASHINGTON, D.C. IN VIEW OF [REDACTED]

[REDACTED]
[REDACTED] WFO IS REQUESTED TO [REDACTED]
[REDACTED]

b3
b6
b7C
b7E

NYO WILL MAINTAIN CONTACT WITH LOGICAL SOURCES AND
FURNISH FBIHQ AND INTERESTED OFFICES PERTINENT INFORMATION
AS IT ARISES.

~~C AND E 3441, REASON 2 AND 3, DRD OCTOBER 13, 1999.~~

BT

#

NY0391 2961310

PP HQ MM NK SF HI MB

DE NY0053

P 120335Z OCT 79

FM NEW YORK (185-899) (M-10)

TO DIRECTOR PRIORITY

MIAMI PRIORITY

NEWARK PRIORITY

SAN FRANCISCO PRIORITY

SAN JUAN PRIORITY (VIA FBIHQ)

WASHINGTON FIELD PRIORITY

BT

UNCLAS E F T O

CAZVIZ; PFO; OO: NEW YORK.

THE FOLLOWING IS A SUMMARY OF EVENTS THAT OCCURRED ON OCTOBER 12, 1979, RELATIVE TO THE CASTRO VISIT:

AT APPROXIMATELY 10:15 AM, FIDEL CASTRO DEPARTED THE CUBAN MISSION TO THE UNITED NATIONS (CMUN) AND MOTORCADED TO THE UNITED NATIONS BUILDING, NYC. HE REMAINED AT THE UNITED NATIONS BUILDING UNTIL APPROXIMATELY 4:00 PM, AT WHICH TIME HE RETURNED TO THE CMUN, 38TH STREET AND LEXINGTON AVENUE.

WHILE CASTRO WAS SPEAKING AT THE UNITED NATIONS,

RECEIVED TELETYPE UNIT

13 OCT 79 13 17 Z

RECEIVED FEDERAL BUREAU OF INVESTIGATION COMMUNICATIONS SECTION

b6 b7C

Exec. AD-Inv.	
Exec. AD-Adm.	
Exec. AD-LES	
Asst. Dir.:	
Adm. Serv.	
Crim. Inv.	
Ident.	
Intell.	
Laboratory	
Legal Coun.	
Plan. & Insp.	
Rec. Mgnt.	
Tech. Servs.	
Training	
Public Affs. Off.	
Telephone Rm.	
Director's Sec'y	

b6 b7C

185-1241-100

REC 20

b3 b6 b7C b7E

10 OCT 16 1979

0-73 WHSR, [redacted]
USSS, Treasury
FAA, USDS, DAG (ERC)
AAG, [redacted]

No action Div I 10-13-79
[redacted]

b3 b6 b7C b7E

60 OCT 31 1979

TELETYPED TO: [redacted]

R

PAGE TWO U N C L A S E F T O

APPROXIMATELY 1500 ANTI-CASTRO CUBANS EXILES HELD A DEMONSTRATION AT DAG HAMMARSKJOLD PLAZA, EAST 47TH STREET AND FIRST AVENUE. THE CUBAN EXILES CARRIED SIGNS AND PLACARDS WHICH INDICATED THAT THEY REPRESENTED "ALPHA 66" AND "ABDALLA." THE DEMONSTRATION WAS GENERALLY PEACEFUL IN NATURE AND THE ONLY INCIDENT OCCURRED WHEN A PRO-CASTRO INDIVIDUAL BEGAN JEERING THE DEMONSTRATORS. AT THIS POINT THE PRO-CASTRO PERSON WAS PHYSICALLY ATTACKED BY A GROUP OF ANTI-CASTRO EXILES. THE NYCPD HANDLED THIS SITUATION AND ONLY MINOR INJURIES WERE SUSTAINED.

AT APPROXIMATELY 3:30 PM, THE CUBAN ANTI-CASTRO CUBAN EXILES MARCHED FROM DAG HAMMARSKJOLD PLAZA TO THE CMUN WHERE THEY HELD A SECOND DEMONSTRATION. THE DEMONSTRATORS WERE CONFINED TO LEXINGTON AVENUE NORTH OF EAST 37TH STREET.

AT ONE POINT DURING THIS DEMONSTRATION, A CUBAN SECURITY GUARD LOCATED ON THE ROOF OF THE CUBAN MISSION, MADE OBSCENE GESTURES TO THE CUBAN EXILES AND CAUSED A FUROR AMONG THE DEMONSTRATORS. USSS AGENTS REPORTED THIS MATTER TO REPRESENTATIVES OF THE CUBAN MISSION AND IT DID NOT OCCUR AGAIN.

PAGE FOUR U N C L A S S I F I E D

DEVICE. COPIES OF [REDACTED] FINGERPRINTS WILL BE FURNISHED TO THE NYO ON OCTOBER 13, 1979 AND WILL BE FORWARDED TO THE IDENTIFICATION DIVISION FOR COMPARISON WITH FINGERPRINTS LIFTS AVAILABLE FROM PRIOR OMEGA 7 BOMBINGS.

b6
b7C

FOR INFORMATION, [REDACTED] WHO WAS ARRESTED ON OCTOBER 10, 1979 AT MIAMI INTERNATIONAL AIRPORT FOR POSSESSION OF A LOADED REVOLVER WAS OBSERVED BY SPECIAL AGENTS, NYO AT THE CMUN.

b6
b7C

BT

cc. ident.

049

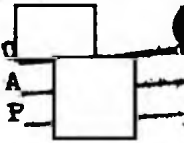

MESSAGE RELAY VIA TELETYPE

DATE	10/13/79	CLASSIFICATION	UNCLAS	PRECEDENCE	PRIORITY
------	----------	----------------	--------	------------	----------

FM DIRECTOR FBI

TO .

FEDERAL GOVERNMENT

od page 3

b3
b6
b7C
b7E

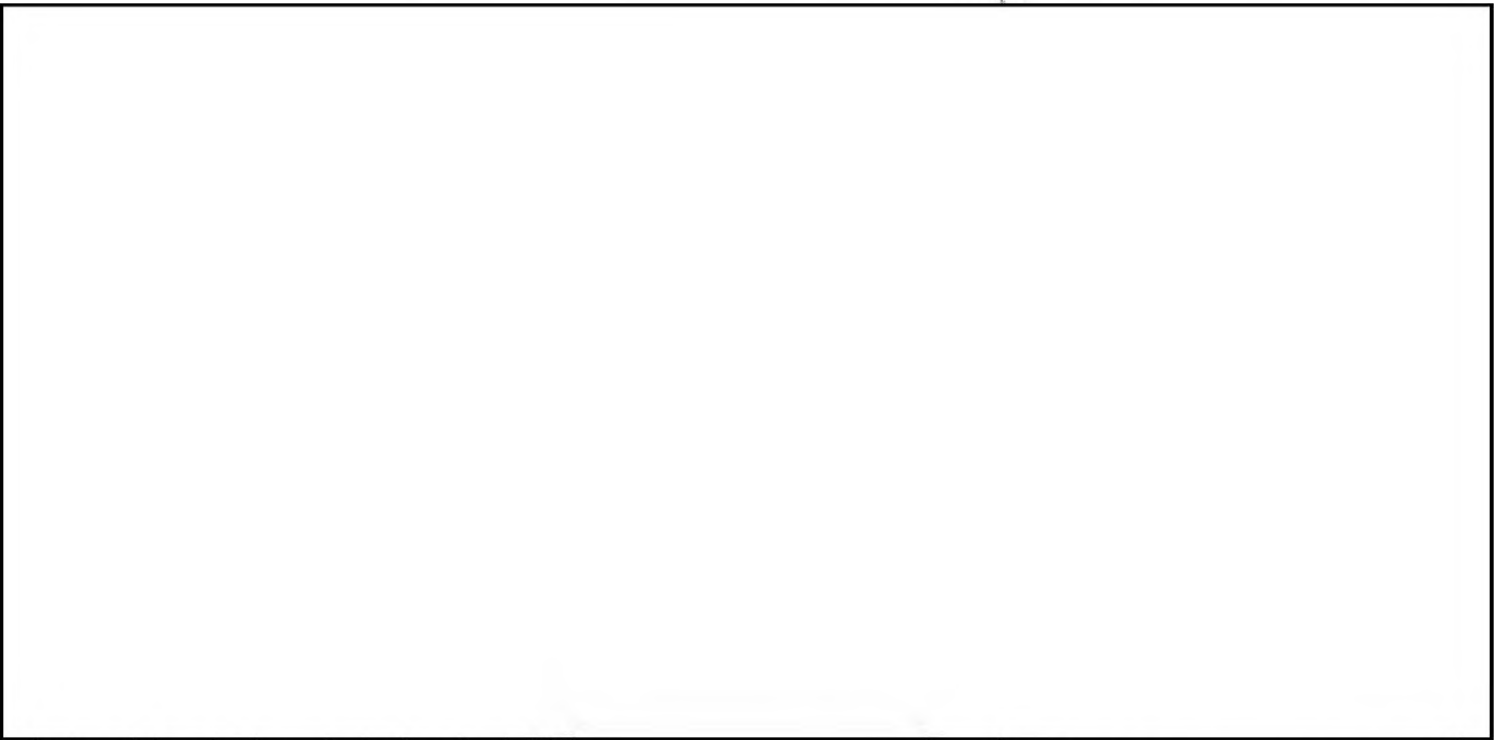

(SERVICE ALSO AVAILABLE TO GOVERNMENT AGENCIES NOT LISTED. CONTACT COMMUNICATIONS CENTER FOR ADDRESSING INFORMATION)

SUBJECT:

105-1241-101

b3
b7E

SEE ATTACHED

REC-106

OCT 15 1979

APPROVED BY	ORIGINATOR	ROOM	TELE EXT.
[Redacted]	[Redacted]	5027	2805

b6
b7C

260

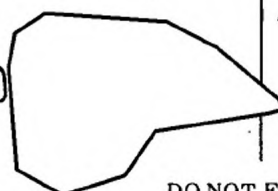

FEDERAL BUREAU OF INVESTIGATION
 COMMUNICATIONS SECTION
1813
 OCT 13 1979

DO NOT FILE WITHOUT COMMUNICATIONS STAMP

USE OF FORM 0-73

1. Only incoming teletype messages which require transmission relay may be prepared for transmission using form 0-73. Use of form 0-73 is restricted to incoming teletype messages received within the last 3 days which require transmission relay; all other teletype messages must be prepared using form 0-93.
2. Additions such as notes and administrative data for a specific addressee are not allowed. If a note or administrative data is required for a particular addressee a separate 0-73 form must be prepared.
3. The message will be transmitted just as it appears. The person approving the message is solely responsible for assuring all necessary editing changes have been made.

PREPARATION OF FORM WHICH CONSISTS OF A PREPRINTED YELLOW.

1. Complete appropriate boxes: date, classification & precedence.
2. List addresses immediately following the "TO" or place a check mark in the appropriate boxes.
3. Type or PRINT the subject in the space provided.
4. Print or type originator's name, room number and telephone extension.
5. Indicate approval for transmission by initialing the "Approved By" box.

PREPARATION OF MESSAGE TO BE TRANSMITTED

1. Xerox 1 copy of incoming teletype message. A notation shall be made on the original incoming teletype "1 copy made for relay to SACS _____, (OR LEGATS) _____, (OR GOVERNMENT AGENCIES) _____."
2. Minor editing changes shall be made on the xerox as follows: using a lead pencil ONLY draw single line through the first and last lines of the heading and connect these lines from top right to bottom left forming a "Z," figure. (DO NOT OBLITERATE THE HEADING.) Use horizontal lines to delete sentences or words. Printed changes of a word or two to the text of the message may be made; however, changes to the existing text involving more than a word or two necessitate the originator to initiate a new message using form 0-93.
3. Administrative data or notes may be typed immediately following the text and will be transmitted to all addressees.
4. When using the 0-73 form to disseminate information to field offices, Legal Attaches and other Government agencies simultaneously, the text, notes and administrative data must be identical for all addressees.

RECEIVED
TELETYPE UNIT

1300179 20 20 z

RECEIVED
FEDERAL BUREAU
OF INVESTIGATION
COMMUNICATIONS SECTION

Exec. AD-Inv.	
Exec. AD-Adm.	
Exec. AD-LES	
Asst. Dir.:	
Adm. Servs.	
Crim. Inv.	
Ident.	
Intell.	
Laboratory	
Legal Coun.	
Plan. & Insp.	
Rec. Mgnt.	
Tech. Servs.	
Training	
Public Affs. Off.	
Telephone Rm.	
Director's Sec'y	

b6
b7C

NY00399 2862018

PR HQ MM NK HI

DE NY 0001

PI32007Z OCT 79

FM NEW YORK (L85-899)

TO DIRECTOR PRIORITY

MIAMI (185-129) PRIORITY

NEWARK (185-122) PRIORITY

SAN JUAN (185-70) PRIORITY (VA FBIHQ)

BT

UNCLAS

GAZVIZ; PFO; OO:NEW YORK

~~RESJTEI, OCTOBER 13, 1979~~

~~FOR INFORMATION, ON OCTOBER 13, 1979,~~ [redacted]

~~ADVISED AS~~

~~below~~ a source advised as follows:

b6
b7C
b7D

~~TELETYPE~~

b6
b7C
b7D

[REDACTED]

The source
[REDACTED] ADVISED [REDACTED]
[REDACTED]

~~NEW YORK WILL SEARCH FILES REGARDING ABOVE INDIVIDUALS~~

ON OCTOBER 13, 1979, UNITED STATES SECRET SERVICE ADVISED THAT A BUS LOAD OF CUBAN EXILES FROM THE NEW JERSEY AREA ARRIVING NEW YORK CITY SAME DATE FOR DEMONSTRATION AT CUBAN MISSION TO THE UNITED NATIONS.

IT WAS ALSO LEARNED THAT FIDEL CASTRO WILL ATTEND A DINNER-RECEPTION AT THE UNITED NATIONS AT 6:00 PM ON OCTOBER 15, 1979, SPECIFICALLY HELD FOR HIM BY NON-ALIGNED NATIONS.

UNITED STATES SECRET SERVICE HAS ALSO ADVISED THAT IT IS BEING RUMORED THAT YASSER ARAFAT IS POSSIBLY PLANNING A TRIP TO NEW YORK SOMETIME DURING THE LATTER PART OF THE WEEK OF OCTOBER 15, 1979 AND THAT FURTHER HE MAY VISIT WITH FIDEL CASTRO. THIS INFORMATION IS ONLY RUMOR AT THIS TIME AND UNITED STATES SECRET SERVICE IS ATTEMPTING TO VERIFY IT.

~~CLASSIFIED AND EXTENDED BY 4478.
REASON 2 & 3.
DRD OCTOBER 13, 1999.~~

b6
b7C

RECEIVED
TELETYPE UNIT

13 OCT 79 05 23z
REC-81
FEDERAL BUREAU
OF INVESTIGATION
COMMUNICATIONS SECTION

Exec. AD-Inv.	_____
Exec. AD-Adm.	_____
Exec. AD-LES	_____
Asst. Dir.:	
Adm. Serv.	[redacted]
Crim. Inv.	_____
Ident.	_____
Intell.	_____
Laboratory	_____
Legal Coun.	_____
Plan. & Insp.	_____
Rec. Mgnt.	_____
Tech. Servs.	_____
Training	_____
Public Affs. Off.	_____
Telephone Rm.	_____
Director's Sec'y	_____

b6
b7C

SJ0352 2860430Z
PP HI MM NK NY
DE SJ 0005
P 130430Z OCT 79
FM SAN JUAN (185-70) (P)
TO DIRECTOR PRIORITY
MIAMI (185-126) PRIORITY
NEWARK (185-122) PRIORITY
NEW YORK (185-899) PRIORITY

BT

~~CONFIDENTIAL~~

CAZVIZ; PFO, (OO: NEW YORK)

THE BELOW IS BEING PROVIDED FOR INFORMATION PURPOSES FOR
ALL OFFICES INVOLVED IN CAPTIONED MATTER:

U.S. SECRET SERVICE, SAN JUAN, ADVISED THAT [redacted]

185-1241-103

[redacted] THREE OF THE "PUERTO
RICAN NATIONALISTS" RECENTLY PARDONED FROM FEDERAL PENITENTIARIES,
DEPARTED SAN JUAN ON AMERICAN AIRLINES FLIGHT 676, AT 10:35 P.M.,
OCTOBER 12, 1979, ARRIVING NEW YORK CITY KENNEDY AIRPORT 2/10/79
OCTOBER 13, 1979, FOR THE PURPOSE OF MEETING WITH FIDEL CASTRO.

b3
b6
b7C
b7E

16 OCT 24 1979

EX-138

b6
b7C

TELETYPE



9-79

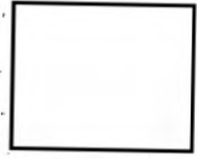
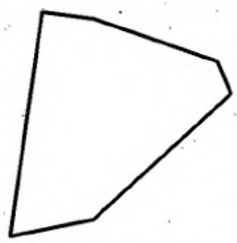

PAGE TWO (185-70) ~~CONFIDENTIAL~~

THEY ARE BEING ACCOMPANIED BY FNU [] AN ATTORNEY FOR []

[] AND ARE TRAVELING UNDER

ASSUMED NAMES AS FOLLOWS: [] TRAVELING UNDER THE NAME

FNU [] TRAVELING UNDER THE NAMES FNU

[]

~~C AND E, 8024, REASONS (2) AND (3), OCTOBER 12, 1999.~~

b6
b7c

#

DEPARTMENT OF JUSTICE
FEDERAL BUREAU OF INVESTIGATION
COMMUNICATION MESSAGE FORM

DECLASSIFICATION AUTHORITY DERIVED FROM:
FBI AUTOMATIC DECLASSIFICATION GUIDE

PAGE 1 OF 2

DATE 10/15/79

CLASSIFICATION ~~SECRET~~

DATE 05-10-2023 PRECEDENCE
EX: [redacted]

ROUTINE

039

SECRET NY DE HQ 0039 SECRET 151640Z OCT 79

START HERE

FM DIRECTOR FBI

TO FBI NEW YORK ROUTINE

BT

~~SECRET~~

CAZVIZ; [redacted]

RE [redacted] DATED OCTOBER 6, 1979. (U)

REFERENCED CABLE [redacted]

[redacted] ON REFERENCED CABLE, AND [redacted]

[redacted] ON REFERENCED CABLE ARE [redacted]

INFORMATION

[redacted] DISCLOSED THAT [redacted]

THE

ABOVE INFORMATION HAS BEEN FURNISHED [redacted] (U)

DO NOT TYPE MESSAGE BELOW THIS LINE

APPROVED [redacted]

DRAFTED BY [redacted]

DATE

10/15/79

ROOM

4147/5

TELE EXT.

4605

SEE NOTE PAGE 3 [redacted]

EX-109

REC 20

ROUTED IN ENVELOPE

7 OCT 16 1979

FEDERAL BUREAU OF INVESTIGATION
COMMUNICATIONS SECTION

OCT 15 1979

DO NOT FILE WITHOUT COMMUNICATIONS STAMP

DO NOT TYPE PAST THIS LINE

b3
b7E

b3
b6
b7C
b7E

b3
b6
b7C
b7E

66

01979

DEPARTMENT OF JUSTICE
FEDERAL BUREAU OF INVESTIGATION
COMMUNICATION MESSAGE FORM

PAGE 2

CONTINUATION SHEET

~~PIAGETATWORDE HQ 0039 SECRET~~

NEW YORK IS INSTRUCTED [REDACTED]

20

18

[REDACTED] RESULTS OF THESE CHECKS SHOULD BE FURNISHED FBIHQ IMMEDIATELY. FBIHQ IS NOT IN POSSESSION OF ANY ADDITIONAL INFORMATION ON [REDACTED] OTHER THAN THAT ALREADY FURNISHED NEW YORK IN REFERENCED CABLE OR THE [REDACTED] INFORMATION. ~~(S)~~

16

14

WITH REGARD TO OTHER INDIVIDUALS CITED IN REFERENCED CABLE, FBIHQ IS NOT IN POSSESSION OF ANY ADDITIONAL INFORMATION NOT ALREADY KNOWN TO NEW YORK. RESULTS OF BUREAU INDICES CHECKS ON [REDACTED]

12

10

[REDACTED] WILL BE FORWARDED TO NEW YORK UPON COMPLETION OF SAID REVIEWS. ~~(S)~~ (U)

8

~~C AND E 5236, REASONS (2, 3), DRD OCTOBER 15, 1999.~~

BT

6

4

2

DO NOT TYPE MESSAGE BELOW THIS LINE

DO NOT TYPE PAST THIS LINE

b3
b6
b7C
b7E
(U)

PAGE THREE

CAZVIZ

[REDACTED]

10/15/79

~~SECRET~~

b6
b7C

NOTE:

New York advised of Bureau information furnished [REDACTED]

b3
b6
b7C
b7E

[REDACTED]
[REDACTED] New York will be furnished Bureau indices checks on remainder of individuals indentified in referenced cable. (~~C~~) (U)

MESSAGE RELAY VIA TELETYPE

098

DATE 10/15/79	CLASSIFICATION Secret	PRECEDENCE Routine
------------------	-------------------------------------	-----------------------

FM DIRECTOR FBI

FEDERAL GOVERNMENT

TO [redacted]

old page 3

b3
b6
b7C
b7E

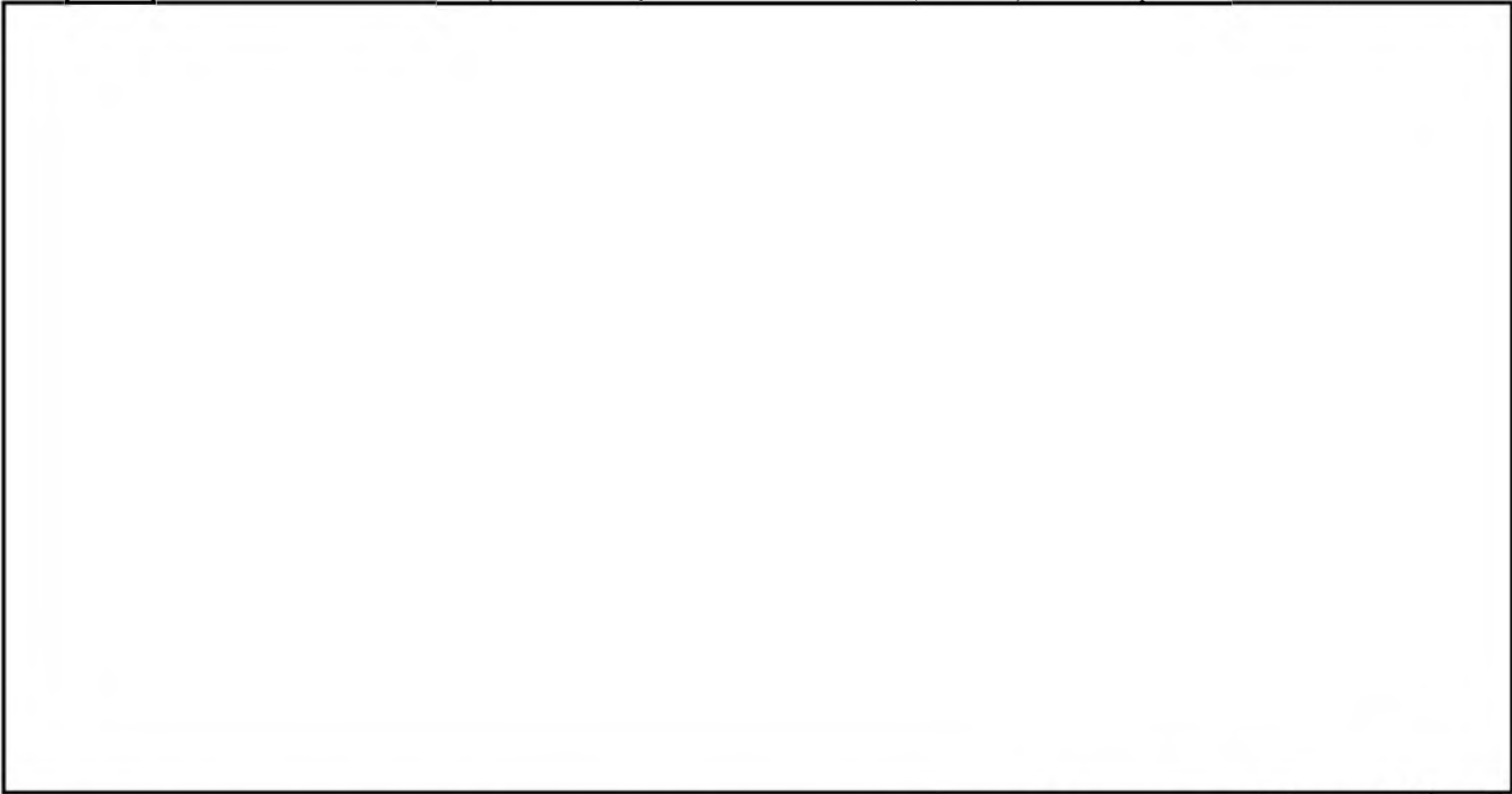

(SERVICE ALSO AVAILABLE TO GOVERNMENT AGENCIES NOT LISTED.
CONTACT COMMUNICATIONS CENTER FOR ADDRESSING INFORMATION)

SUBJECT: Visit of Fidel Castro to the U.S.

185-1241-106

[redacted]

REC 11

WARNING notice - ~~WINDTET, WOPAN, OREON~~

b3
b6
b7C
b7E

APPROVED BY [redacted]	ORIGINATOR [redacted]	ROOM 4147	TELE EXT. 4605
---------------------------	--------------------------	--------------	-------------------

OCT 16 1979

FEDERAL BUREAU OF INVESTIGATION
COMMUNICATIONS SECTION
0401
OCT 16 1979

6 1979

DO NOT FILE WITHOUT COMMUNICATIONS STAMP

2

USE OF FORM 0-73

15 OCT 79 22 54
RECEIVED
FEDERAL BUREAU OF INVESTIGATION
COMMUNICATIONS SECTION

1. Only incoming teletype messages which require transmission relay may be prepared for transmission using form 0-73. Use of form 0-73 is restricted to incoming teletype messages received within the last 3 days which require transmission relay; all other teletype messages must be prepared using form 0-93.
2. Additions such as notes and administrative data for a specific addressee are not allowed. If a note or administrative data is required for a particular addressee a separate 0-73 form must be prepared.
3. The message will be transmitted just as it appears. The person approving the message is solely responsible for assuring all necessary editing changes have been made.

PREPARATION OF FORM WHICH CONSISTS OF A PREPRINTED YELLOW.

1. Complete appropriate boxes: date, classification & precedence.
2. List addresses immediately following the "TO" or place a check mark in the appropriate boxes.
3. Type or PRINT the subject in the space provided.
4. Print or type originator's name, room number and telephone extension.
5. Indicate approval for transmission by initialing the "Approved By" box.

PREPARATION OF MESSAGE TO BE TRANSMITTED

1. Xerox 1 copy of incoming teletype message. A notation shall be made on the original incoming teletype "1 copy made for relay to SACS _____, (OR LEGATS) _____, (OR GOVERNMENT AGENCIES) _____."
2. Minor editing changes shall be made on the xerox as follows: using a lead pencil ONLY draw single line through the first and last lines of the heading and connect these lines from top right to bottom left forming a "Z," figure. (DO NOT OBLITERATE THE HEADING.) Use horizontal lines to delete sentences or words. Printed changes of a word or two to the text of the message may be made; however, changes to the existing text involving more than a word or two necessitate the originator to initiate a new message using form 0-93.
3. Administrative data or notes may be typed immediately following the text and will be transmitted to all addressees.
4. When using the 0-73 form to disseminate information to field offices, Legal Attaches and other Government agencies simultaneously, the text, notes and administrative data must be identical for all addressees.

b6
b7c

RECEIVED
TELETYPE UNIT

16 OCT 79 03 35z

RECEIVED
FEDERAL BUREAU
OF INVESTIGATION
COMMUNICATIONS SECTION

Exec. AD-Inv.	_____
Exec. AD-Adm.	_____
Exec. AD-LES	_____
Asst. Dir.:	
Adm. Serv.	_____
Crim. Inv.	_____
Ident.	_____
Intell.	_____
Laboratory	_____
Legal Coun.	_____
Plan. & Insp.	_____
Rec. Mgnt.	_____
Tech. Servs.	_____
Training	_____
Public Affs. Off.	_____
Telephone Rm.	_____
Director's Sec'y	_____

NK0019 2890108

RR HI MM NY SJ WF

DE NK 019

R 160332Z OCT 79

FM NEWARK (185-122) (RUC) (C-3)

TO DIRECTOR (ROUTINE)

MIAMI (185-126) (ROUTINE)

NEW YORK (185-899) (ROUTINE)

SAN JUAN (VIA FBIHQ) (185-70) (ROUTINE)

WFO (ROUTINE)

BT

UNCLAS E F T O

CAZVIZ; PFO; OO: NEW YORK

IN VIEW OF THE RETURN OF CUBAN PREMIER FIDEL CASTRO TO CUBA

ON OCTOBER 14, 1979, NEWARK IS PLACING CAPTIONED CASE IN RUC STATUS.

INVESTIGATION OF POTENTIAL VALUE GENERATED BY CAPTIONED MATTER

WILL BE PURSUED THROUGH EXISTING CASES IN THE ANTI-CASTRO CUBAN

FIELD.

BT

b6
b7c

b3
b6
b7c
b7E

185-1241-108

OCT 16 1979

b6
b7c

67 991070254
TELETYPED TO:
S-L

Exec. AD-Inv.	b6
Exec. AD-Adm.	b7C
Exec. AD-LES	
Asst. Dir.:	
Adm. Serv.	
Crim. Inv.	
Id.	
Int.	
Lab.	
Legal Coun.	
Plan. & Insp.	
Rec. Mgnt.	
Tech. Servs.	
Training	
Public Affs. Off.	
Telephone Rm.	b3
Director's Sec'y	b6

NY0566 2911519

PP HQ

DE NY 010

P 181518Z OCT 79

FM NEW YORK [redacted]

TO DIRECTOR PRIORITY

BT

10 OCT 79 15 35z

RECEIVED
FEDERAL BUREAU
OF INVESTIGATION
COMMUNICATIONS SECTION

~~CONFIDENTIAL~~

VISIT OF FIDEL CASTRO TO THE UNITED STATES IN CONNECTION WITH

THE UNITED NATIONS GENERAL ASSEMBLY, OCTOBER, 1979; [redacted]

b3
b7E

REBUTEL, DATED OCTOBER 15, 1979 ENTITLED "CAZVIZ; [redacted]

~~SECRET~~

(U)

FOR INFORMATION OF THE BUREAU, [redacted]

b6
b7C
b7E

[redacted]

What from [redacted] 10/22/79

AS OF 2:00 PM, OCTOBER 17, 1979, [redacted]

b6
b7C

HAD BEEN OBSERVED AT THE CMUN AT 315 LEXINGTON AVENUE AND TO DATE, THERE ARE NO RECORDS INDICATING THAT HE HAS YET DEPARTED THE UNITED STATES. ~~(S)~~ (U)

V-18 DE-21

b6
b7C

185-12 [redacted] 109

OCT 25 1979

64 NOV 19 1979

PAGE TWO ~~C O N F I D E N T I A L~~

THE BUREAU WILL BE ADVISED WHEN DOES IN FACT

b6
b7c

DEPART THE UNITED STATES. ~~(S)~~ (U)

~~C AND E 3441, REASON 2 & 3, DRD OCTOBER 18, 1999~~

BT

RECEIVED [redacted]
TELETYPE UNIT

20 OCT 79 00 14z

RECEIVED
FEDERAL BUREAU
OF INVESTIGATION
COMMUNICATIONS SECTION

Exec. AD-Inv.	
Exec. AD-Adm.	
Exec. AD-LES	
Asst. Dir.:	
Adm. Servs.	
Crim. Inv.	
Ident.	
Intell.	
Laboratory	
Legal Coun.	
Plan. & Insp.	
Rec. Mgnt.	
Tech. Servs.	
Training	
Public Affs. Off.	
Telephone Rm.	
Director's Sec'y	

b3
b6
b7C
b7E

VZCZCWF0162

RR HI NY

WF 0013 2922230

Z NY SSSSS

R 192202Z OCT 79

FM FBI WASHINGTON FIELD [redacted]

TO DIRECTOR FBI ROUTINE

ATTENTION: INTELLIGENCE DIVISION

FBI NEW YORK [redacted] ROUTINE

BT

~~SECRET~~

VISIT OF FIDEL CASTRO TO THE UNITED STATES IN CONNECTION WITH
THE UNGA, OCTOBER, 1979, [redacted]

REFERENCE NEW YORK TELETYPE TO WASHINGTON FIELD

OCTOBER 16, 1979, REPORTING INFORMATION FROM [redacted]

TO EFFECT THAT [redacted]

[redacted]

OCT 22 1979

[redacted] NEW YORK REPORTED THAT ABOVE INFOR-
MATION WAS FURNISHED TO FEDERAL BUREAU OF INVESTIGATION HEAD-
QUARTERS BY TELETYPE DATED OCTOBER 13, 1979. (S) (U)

SINCE SEPTEMBER 21, 1979, [redacted] HAS BEEN REPORTING

[redacted] OV 6, 1979

b3
b6
b7C
b7E

X-48 2, 3

b3
b6
b7C
b7E

[redacted]

b3
b6
b7C
b7E

[redacted]

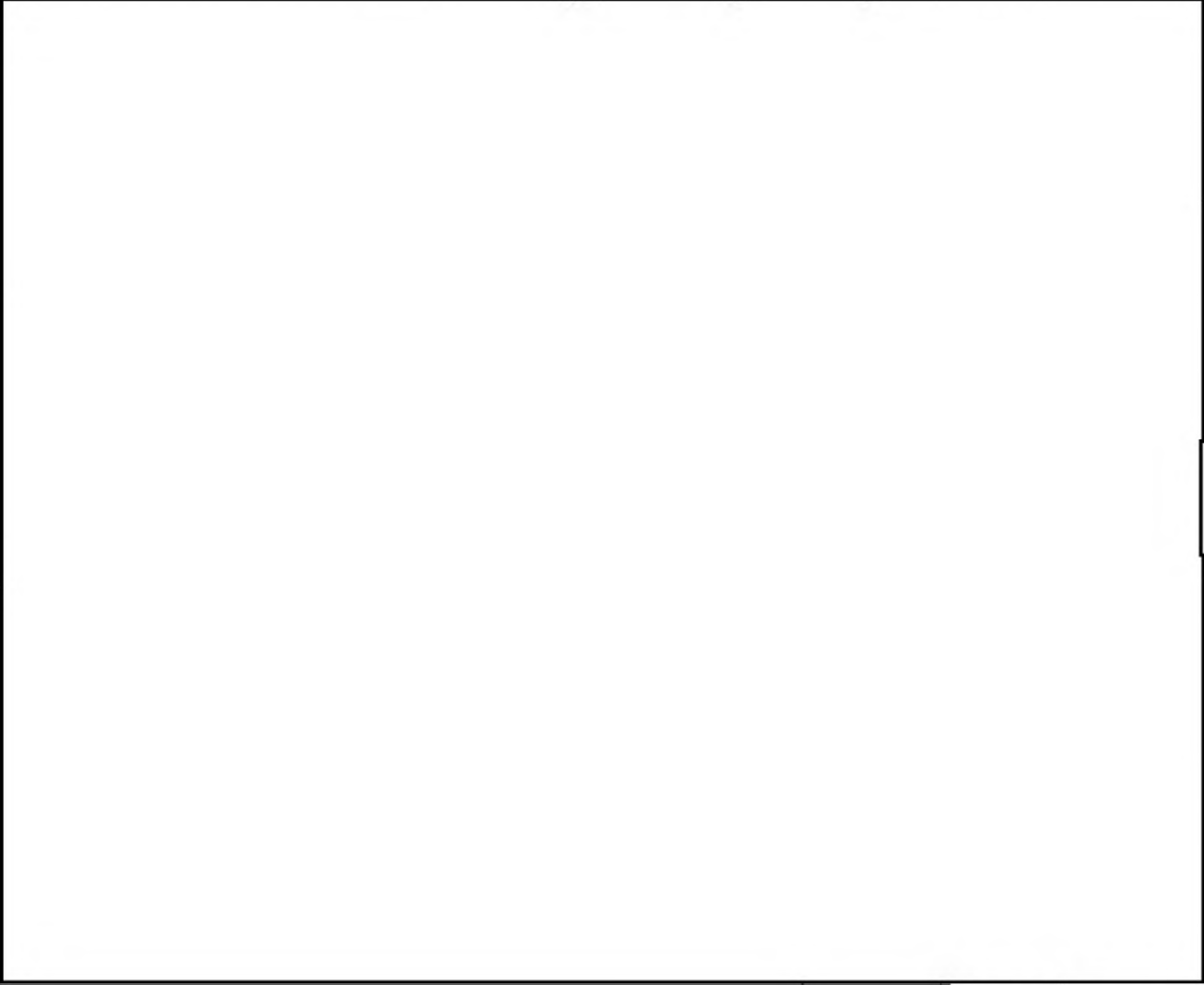

b3
b6
b7C
b7E



~~(S)~~ (U)



MENTIONED IN REFERENCED NEW YORK

b6
b7C

PAGE THREE DE WF 0013 ~~SECRET~~

TELETYPE APPEARS TO BE PROBABLY IDENTICAL WITH [REDACTED]

[REDACTED]

~~(S)~~ (U)

[REDACTED]

b3
b6
b7C
b7E

[REDACTED]

~~(S)~~ (U)

~~CLASSIFIED AND EXTENDED BY: 5051, FCIM, II, (2 & 3), D~~

~~OCTOBER 19, 1999.~~

NNNN

Exec. AD-Adm.	b6
Exec. AD-Inv.	b7C
Exec. AD-LES	
Asst. Dir.:	
Adm. Serv.	
Crim. Inv.	
Ident.	
Intell.	
Laboratory	
Legal Coun.	
Plan. & Insp.	
Rec. Mgmt.	
Tech. Serv.	
Training	
Off. Cong. & Public Affs.	
Telephone Rm.	
Director's Sec'y	b6

RECEIVED
TELETYPE UNIT

6 Oct 79 01 56z

RECEIVED
FEDERAL BUREAU
OF INVESTIGATION
COMMUNICATIONS SECTION

NY0116 2790137

PP HQ MM SF HI

DE NY 0053

P050108Z OCT 79

FM NEW YORK (185-899) (M-10)

TO DIRECTOR PRIORITY

MIAMI PRIORITY

SAN FRANCISCO PRIORITY

SAN JUAN PRIORITY (VIA FBIHQ)

BT

~~SECRET~~

PROPOSED VISIT OF CUBAN PREMIER FIDEL CASTRO TO THE UNITED STATES,
OCTOBER 1979; PFO MATTER; OO: NEW YORK.

RENYTELCALS TO SAN JUAN AND MIAMI, OCTOBER 4, 1979.

ON OCTOBER 4, 1979, NYO CASE AGENT CONTACTED SAN JUAN
CASE AGENT FOR THE PURPOSE OF SOLICITING HIS COMMENTS IN

REGARD TO FEASIBILITY OF NYO LOCATING AND INTERVIEWING [redacted]

[redacted] IN PARTICULAR NYO WAS CONCERNED WHETHER SUCH AN INTER-
VIEW [redacted] IT WAS THE OPINION [redacted] OCT 18 1979

OF SAN JUAN CASE AGENT THAT [redacted]

[redacted]

[redacted]

TELETYPED TO 66 NOV 19 1979

b6
b7C

b3
b6
b7C
b7D

EX-100 REC-81 185-1241-113

ON THE EVENING OF OCTOBER 4, 1979, SPECIAL AGENTS (SAS), NYO AND SAS UNITED STATES SECRET SERVICE CONDUCTED THE FOLLOWING INVESTIGATION AT [REDACTED]

b6
b7C

[REDACTED] WAS INTERVIEWED AND HE WAS ADVISED BY INTERVIEWING SAS THAT THE INTERVIEW WAS BEING CONDUCTED AT THE REQUEST UNITED STATES SECRET SERVICE. HE WAS FURTHER ADVISED THAT THE UNITED STATES SECRET SERVICE HAS THE PROTECTIVE RESPONSIBILITY FOR THE PROPOSED VISIT OF FIDEL CASTRO AND THAT

[REDACTED] IS KNOWN TO THEM AS A ANTI-CASTRO CUBAN EXILE.

b6
b7C

[REDACTED] WAS FURTHER ADVISED THAT THE RECENT INCIDENT DURING WHICH HE FIRED A 45 CALIBER HANDGUN AT HIS TELEVISION SET BECAUSE CASTRO WAS BEING INTERVIEWED ON A PROGRAM WAS FURNISHED TO UNITED STATES SECRET SERVICE BY THE SANTA CLARA, CALIFORNIA POLICE DEPARTMENT. [REDACTED] WAS ALSO TOLD THAT THE FBI AND THE UNITED STATES SECRET SERVICE ARE AWARE THAT HE AND OTHER CUBAN EXILES IN CALIFORNIA PRACTICE MILITARY MANEUVERS IN A NATIONAL PARK IN CALIFORNIA IN 1977. IT WAS FURTHER POINTED OUT TO

[REDACTED] THAT THE FBI AND UNITED STATES SECRET SERVICE ARE IN THE PROCESS OF INTERVIEWING MANY KNOWN ANTI-CASTRO CUBAN EXILES FOR THE PURPOSE OF PREVENTING ANY VIOLENCE IN CONNECTION WITH THE

b6
b7C

VISIT OF FIDEL CASTRO.

[] ADVISED THE HE RESIDES AT []
[] AND THAT HE TRAVELLED TO NEW YORK ALONE ON
TUESDAY EVENING, OCTOBER 2, 1979. [] STATED THAT THE PURPOSE
OF HIS TRIP TO NEW YORK IS TO ATTEND THE ANTI-CASTRO DEMONSTRAT-
ION PLANNED FOR OCTOBER 5, 1979 AT THE UNITED NATIONS. HE
STATED THAT [] ALPHA 66 IN THE SANTA CLARA
AREA AND IS A VETERAN OF THE BAY OF PIGS INVASION. HE SPENT
22 MONTHS AS A PRISONER IN CUBA FOLLOWING THE BAY OF PIGS. HE
FURTHER ADVISED THAT HE HAS NO TRAINING IN EXPLOSIVE AND IN
FACT RECEIVED TWO WEEKS OF TRAINING WITH A 30 CALIBER MACHINE
GUN BEFORE PARTICIPATING IN THE INVASION. [] MADE IT
CLEAR THAT HE WAS HERE TO EXERCISE HIS RIGHT TO DEMONSTRATE
AGAINST CASTRO AND THAT HE HAS NO PLANS TO VIOLATE ANY LAWS
IN CONNECTION WITH CASTRO'S VISIT. [] ASKED ON WHAT BASIS
THE FBI AND SECRET SERVICE SEARCHED HIS RESIDENCE []
[] WAS TOLD THAT HE SHOULD CONTACT []
[] WHO WILL EXPLAIN THE CIRCUMSTANCES TO HIM.
[] WAS SHOWN PHOTOGRAPHS OF KNOWN CUBAN NATIONALIST MOVE-
MENT MEMBERS IN THE NEW YORK/NEW JERSEY AREA, BUT WAS UNABLE

b6
b7c

b6
b7c

b6
b7c

TO IDENTIFY ANYONE. HE WAS ALSO SHOWN PHOTOGRAPHS OF BUREAU FUGITIVES [REDACTED], BUT WAS UNABLE TO IDENTIFY EITHER OF THEM. HE STATED THAT THE NAME [REDACTED] IS FAMILIAR TO HIM FROM THE LETELIER INVESTIGATION BUT THE NAME [REDACTED] IS NOT KNOWN TO HIM. HE RECOGNIZED SOME OF THE NAMES OF CNM MEMBERS BUT STATED THAT HE IS NOT PERSONALLY ACQUAINTED WITH ANY OF THEM AS THIS IS HIS FIRST TRIP TO THE NEW YORK NEW JERSEY AREA. [REDACTED] IS DESCRIBED AS A WHITE MALE, DOB:

b6
b7C

b6
b7C

[REDACTED]

THE FOLLOWING INDIVIDUALS WERE ALSO PRESENT AT THE APARTMENT AT [REDACTED], AND WERE SEPARATED AND INTERVIEWED BY BUREAU AGENTS AND SECRET SERVICE AGENTS: [REDACTED]

b6
b7C

[] ANDRES NAZARIO SARGEN, DOB: MARCH 11, 1926, ADDRESS: 24-34
NORTH WEST 29TH STREET, MIAMI, FLORIDA, MEMBER ALPHA 66;

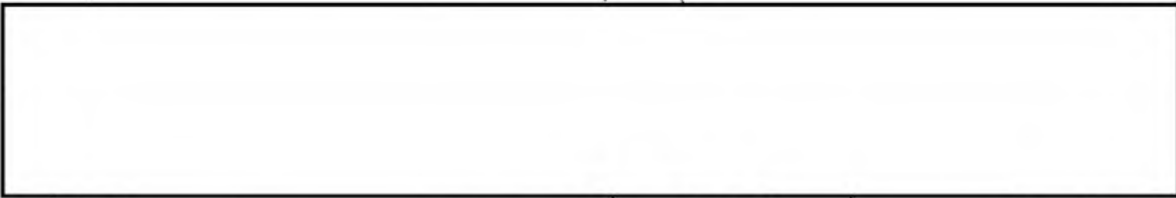

b6
b7C

ALSO AT THE APARTMENT OF [] WAS [] REPORTER,
MIAMI NEWS, [] WAS NOT
INTERVIEWED BY BUREAU AGENTS OR SECRET SERVICE AGENTS AND
WAS NOT PRIVY TO INTERVIEWS OF OTHER ALPHA 66 MEMBERS.

b6
b7C

IN ESSENCE, ALL OF THE ABOVE INDIVIDUALS STATED THAT THEY
PLAN TO ATTEND THE ANTI-CASTRO DEMONSTRATION AND HAD NO PLANS
TO COMMIT ANY VIOLENT ACTS OR VIOLATE ANY LAWS.

FD-302'S CONTAINING RESULTS OF ABOVE INTERVIEWS WILL BE
FURNISHED INTERESTED OFFICES AT A LATER DATE.

~~C AND E 5815, REASON 2 AND 3, DRD OCTOBER 5, 1999.~~

BT

#

cc: C 10

b6
b7C

BY: [redacted]
O
A
P

074

MESSAGE RELAY VIA TELETYPE

DATE 10/11/79	CLASSIFICATION SECRET	PRECEDENCE PRIORITY
------------------	-------------------------------------	------------------------

FM DIRECTOR FBI

TO
[redacted]

FEDERAL GOVERNMENT

b3
b6
b7C
b7E

[redacted]

[Large empty rectangular area]

(SERVICE ALSO AVAILABLE TO GOVERNMENT AGENCIES NOT LISTED.
CONTACT COMMUNICATIONS CENTER FOR ADDRESSING INFORMATION)

SUBJECT: VISIT OF CUBAN PREMIER FIDEL CASTRO TO THE U.S.; PFD MATTER. 185-1241-117

EX-109 EC 12

OCT 12 1979

APPROVED BY [redacted]	ORIGINATOR [redacted]	ROOM 4147	TELE EXT. 4608
---------------------------	--------------------------	--------------	-------------------

b6
b7C

FEDERAL BUREAU OF INVESTIGATION
COMMUNICATIONS SECTION
1857 [redacted]
OCT 11 1979

3 NOV 16 1979

DO NOT FILE WITHOUT COMMUNICATIONS STAMP

FBI/DOJ

USE OF FORM 0-73

- 11 OCT 79 16 55
FEDERAL BUREAU OF INVESTIGATION
COMMUNICATIONS SECTION
1. Only incoming teletype messages which require transmission relay may be prepared for transmission using form 0-73. Use of form 0-73 is restricted to incoming teletype messages received within the last 3 days which require transmission relay; all other teletype messages must be prepared using form 0-93.
 2. Additions such as notes and administrative data for a specific addressee are not allowed. If a note or administrative data is required for a particular addressee a separate 0-73 form must be prepared.
 3. The message will be transmitted just as it appears. The person approving the message is solely responsible for assuring all necessary editing changes have been made.

PREPARATION OF FORM WHICH CONSISTS OF A PREPRINTED YELLOW.

1. Complete appropriate boxes: date, classification & precedence.
2. List addresses immediately following the "TO" or place a check mark in the appropriate boxes.
3. Type or PRINT the subject in the space provided.
4. Print or type originator's name, room number and telephone extension.
5. Indicate approval for transmission by initialing the "Approved By" box.

PREPARATION OF MESSAGE TO BE TRANSMITTED

1. Xerox 1 copy of incoming teletype message. A notation shall be made on the original incoming teletype "1 copy made for relay to SACS _____, (OR LEGATS) _____, (OR GOVERNMENT AGENCIES) _____."
2. Minor editing changes shall be made on the xerox as follows: using a lead pencil ONLY draw single line through the first and last lines of the heading and connect these lines from top right to bottom left forming a "Z," figure. (DO NOT OBLITERATE THE HEADING.) Use horizontal lines to delete sentences or words. Printed changes of a word or two to the text of the message may be made; however, changes to the existing text involving more than a word or two necessitate the originator to initiate a new message using form 0-93.
3. Administrative data or notes may be typed immediately following the text and will be transmitted to all addressees.
4. When using the 0-73 form to disseminate information to field offices, Legal Attaches and other Government agencies simultaneously, the text, notes and administrative data must be identical for all addressees.

FBI

TRANSMIT VIA:

- Teletype
- Facsimile
- AIRTEL

PRECEDENCE:

- Immediate
- Priority
- Routine

CLASSIFICATION:

- TOP SECRET
- SECRET
- CONFIDENTIAL
- UNCLAS E F T O
- UNCLAS

Date 10/30/79

b6
b7C

TO: DIRECTOR, FBI

FROM: SAC, LOS ANGELES (185-273) (11) (RUC)

RE: CAZVIZ
PFO
00: New York

In view of the fact that no incidents occurred at New York relative to FIDEL CASTRO's visit and that he has now departed the United States, no further investigation is being conducted by the Los Angeles Division.

(X)

(9)

185-1241-116

- 2 - Bureau
- 2 - New York (185-899)
- 1 - Los Angeles

NOV 5 1979

b6
b7C

(5)

A

Transmitted _____ (Number) _____ (Time) Per _____

64 NOV 16 1979

FBI

TRANSMIT VIA:

- Teletype
- Facsimile
- airtel

PRECEDENCE:

- Immediate
- Priority
- Routine

CLASSIFICATION:

- TOP SECRET
- SECRET
- CONFIDENTIAL
- UNCLAS E F T O
- UNCLAS

11/1/79

Date

b6
b7c

TO: DIRECTOR, FBI

FROM: SAC, WFO (185-734) (RUC)

CAZVIZ

PFO

(OO:NY)

WFO placing captioned matter in RUC status.
 WFO will continue investigation in anti-CASTRO field
 through appropriate existing cases.

b6
b7c

- 2 - Bureau
- 2 - New York (185-899) (M-10)
- 1 - WFO

185-1241/17

NOV 2 1979

b6
b7c

Approved

Transmitted

Per

(Number)

(Time)

64 NOV 17 1979

b6
b7c

FBI

TRANSMIT VIA:

- Teletype
- Facsimile
- AIRTEL

PRECEDENCE:

- Immediate
- Priority
- Routine

CLASSIFICATION:

- TOP SECRET
- SECRET
- CONFIDENTIAL
- UNCLAS E F T O
- UNCLAS

~~CONFIDENTIAL~~

Date 10/18/79

TO: DIRECTOR, FBI
 FROM: SAC, NEWARK (185-122) (P)
 SUBJECT: CAZVIZ
 PFO
 (OO: NEW YORK)

ALL INFORMATION CONTAINED
HEREIN IS UNCLASSIFIED
EXCEPT WHERE SHOWN
OTHERWISE

6-17-86
 Classified by [redacted]
 Declassify on: OADR
 [redacted]

b6
b7c

Enclosed for the Bureau are five copies, and for New York two copies, of an LHM dated and captioned, "VISIT OF CUBAN PREMIER FIDEL CASTRO TO THE UNITED STATES".

The confidential source mentioned herein is

[redacted] (S)

b3
b6
b7c
b7D

- ENCLOSURE
- 2 - Bureau (Encs. 5)
 - 2 - New York (Encs. 2)
 - 2 - Newark

135-147-118

OCT 22 1979

b6
b7c

- (6) 1 c/c enc sent [redacted] 10/29
- 1 c/c enc sent AAC/GCI 10/29
- 1 c/c enc sent AAG/ISS 10/29

66 DEC 5 1979

CONFIDENTIAL

USSS 10/29 / 1 c/c A/tel retain am. 4051-10/29

b3
b6
b7c
b7D
b7E

Approved: _____ Transmitted _____ (Number) _____ (Time) Per _____



~~CONFIDENTIAL~~

UNITED STATES DEPARTMENT OF JUSTICE
FEDERAL BUREAU OF INVESTIGATION

In Reply, Please Refer to
File No.

Newark, New Jersey

~~CONFIDENTIAL~~

October 18, 1979

~~6-17-86
Classified by
Declassify on: OADR~~

b6
b7C

~~ALL INFORMATION CONTAINED
HEREIN IS UNCLASSIFIED
EXCEPT WHERE SHOWN
OTHERWISE~~

VISIT OF CUBAN PREMIER FIDEL CASTRO
TO THE UNITED STATES

On October 15, 1979, a confidential, reliable source
advised as follows:

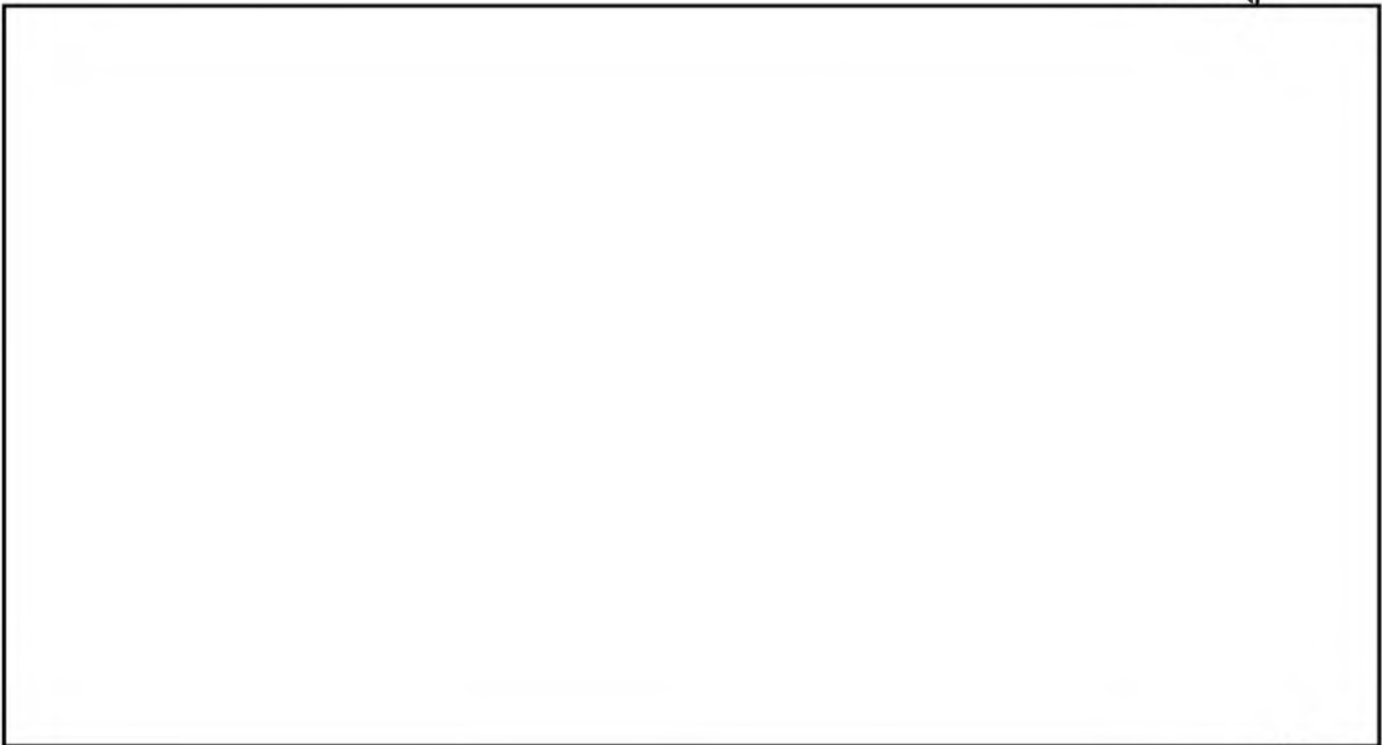

b3
b6
b7C
b7D

~~CONFIDENTIAL~~

~~CLASSIFIED AND EXTENDED BY 953
REASON FOR EXTENSION, FCIM, II, 1-2.4.2 (2AND3)
DATE OF REVIEW FOR DECLASSIFICATION
OCTOBER 18, 1999~~

~~CONFIDENTIAL~~

105-1241-118

This document contains neither
recommendations nor conclusions of
the FBI. It is the property of
the FBI and is loaned to your agency;
it and its contents are not to be
distributed outside your agency.

1*

ENCLOSURE

[Redacted]

10/29/79

Pursuant to our conversation, the information contained in the LHM can be disseminated to the State Department [Redacted]

b3
b6
b7C
b7E

pursuant to the "routine use" exception of the Privacy Act.

See Title 5, U.S.C. § 552a(b)(3)

Our "routine use" for the Central Records System is set forth in Volume 43, Federal Register, page 44693. The information can

be disseminated to State Dept

[Redacted] under the "routine use" exception if ~~they~~ the right and need for them to have access to the information exists.

b3
b6
b7C
b7E

As to the DOS, the information can be disseminated under Title 5, U.S.C., § 552(a)(b)(1) if the DOS has a need to know about the info.

ALL INFORMATION CONTAINED
HEREIN IS UNCLASSIFIED
DATE 1-17-86 BY [Redacted] FOIA # 269,595

also

[Redacted]

[Redacted]

in

b6
b7C

last para.

Discrimination should not
affect lawsuit

[Redacted]

b6
b7C

DEPARTMENT OF JUSTICE
FEDERAL BUREAU OF INVESTIGATION
INTERNAL ROUTING/ACTION SLIP

TO	BLDG.	ROOM	NAME/TITLE/ORGANIZATION	TO	BLDG.	ROOM	NAME/TITLE/ORGANIZATION
			DIVISION FRONT OFFICE				UNIT CHIEFS
			(TL#)	JEH	1427	(253)	[Redacted] b6
JEH	5012	(233)	[Redacted]	JEH	4072	(242)	[Redacted] b7C
JEH	5012	(233)	[Redacted]	JEH	4084	(242)	Vacant
JEH	3012	(231)	[Redacted]	JEH	4062	(242)	[Redacted]
							SECTION SUPERVISORS
JEH	5012	(233)	[Redacted]	JEH	4062	(242)	[Redacted]
JEH	5012	(233)	[Redacted]	JEH	4072	(242)	[Redacted]
JEH	3012	(231)	[Redacted]	JEH	4052	(242)	[Redacted]
				JEH	4084	(242)	[Redacted]
			SECTION CHIEFS	JEH	4052	(242)	[Redacted]
JEH	5030	(233)	Mr. Gow	JEH	1427	(253)	[Redacted]
JEH	5155	(233)	Mr. Henahan	JEH	1427	(253)	[Redacted]
JEH	3823	(231)	Mr. Lawn	JEH	1427	(253)	[Redacted]
JEH	4042	(242)	Mr. Mignosa	JEH	4052	(242)	[Redacted]
JEH	3076	(231)	Mr. McWeeney	JEH	4062	(242)	[Redacted]
				JEH	4084	(253)	[Redacted]
			SECTION FRONT OFFICE	JEH	1427	(242)	[Redacted]
JEH	4042	(242)	[Redacted]	JEH	4084	(242)	[Redacted]
JEH	4042	(242)	[Redacted]	JEH	4062	(253)	[Redacted]
JEH	4042	(242)	[Redacted]	JEH	1427	(242)	[Redacted]
				JEH	4072	(242)	[Redacted]
			RECORDS SECTION				*****
JEH	5648	(222)	Filing	JEH	4437	(242)	Reading Room
JEH	4336	(111)	Mail Processing	JEH	5425	(243)	Name Check Section
JEH	4336	(111)	Place on record & return	JEH	5443 A	(115)	Name Searching Unit
JEH	1B327	(152)	MAIL ROOM	JEH	5081	(233)	Steno Pool
JEH	6247	(244)	TELETYPE UNIT				*****
JEH	1262	(153)	Voucher Unit				M

[Redacted]

Room 7427

ALL INFORMATION CONTAINED
HEREIN IS UNCLASSIFIED
DATE 5-7-86 BY [Redacted]

- RECOMMENDATION/COMMENT
- SEE REMARKS ON REVERSE
- MAKE COPIES (NO.)
- RETURN (BY)
- LOG
- FILE
- SEE ME
- CALL ME
- NECESSARY ACTION
- COORDINATE
- PER INQUIRY
- INFORMATION

FROM [Redacted]

BLDG. J. EDGAR HOOVER (JEH) ROOM 4048
 PHONE 4660 DATE 10/22/79

CRIMINAL INVESTIGATIVE DIVISION

Please review attached LHM and advise whether or not this ^{INS} can be disseminated outside of FBI.

Thanks



b6
b7c

RECEIVED
OCT 23 10 55 AM 1979
LEGAL COUNSEL

[Redacted]

0609 3030030Z

30 OCT 79 01 44

RECEIVED
FEDERAL BUREAU
OF INVESTIGATION
COMMUNICATIONS SECTION

Exec. AD-Adm.	
Exec. AD-LES	
Asst. Dir.:	
Adm.	
Crim.	
Ident.	
Intell.	b6
Laboratory	b7C
Legal Coun.	
Plan. & Insp.	
Rec. Mgnt.	
Tech. Servs.	
Training	
Public Affs. Off.	
Telephone Rm.	
Director's Sec'y	

many items when repaired (1/29/79)

HI MM NK NY WP CG SF

E SJ 002

293030030Z OCT 79

FM SAN JUAN (185-70)(RUC)

TO DIRECTOR ROUTINE

MIAMI (185-126) ROUTINE

NEWARK (185-122) ROUTINE

NEW YORK (185-899) ROUTINE

WASHINGTON FIELD OFFICE ROUTINE

CHICAGO ROUTINE

SAN FRANCISCO ROUTINE

BT

UNCLAS

CAZVIZ; PFO; OO: NEW YORK

185-1241-119

SAN JUAN PLACING CAPTIONED CASE IN RUC STATUS.

OCT 31 1979

INVESTIGATION OF POTENTIAL VALUE GENERATED BY THIS MATTER

WILL BE PURSUED THROUGH EXISTING CASES.

BT

b6
b7C

RECEIVED

63 NOV 15 1979

301 303 1529

RR HQ NK NY WF CG SF

DE MM

R 30 1520Z OCT 79

FM MIAMI (185-126) RUC

TO DIRECTOR ROUTINE

NEWARK (185-122) ROUTINE

NEW YORK (185-899) ROUTINE

WASHINGTON FIELD ROUTINE

CHICAGO ROUTINE

SAN FRANCISCO ROUTINE

SAN JUAN VIA WASHINGTON ROUTINE

BT

UNCLAS

CAZVIZ; PFO, OO: NEW YORK.

MIAMI DIVISION PLACING CAPTIONED CASE IN RUC STATUS.
MIAMI WILL CONTINUE INVESTIGATION IN ANTI-CASTRO FIELD
THROUGH APPROPRIATE EXISTING CASES.

BT

185-1241-120

RECEIVED
TELETYPE UNIT

30 OCT 79 15 23z

FEDERAL BUREAU
OF INVESTIGATION
COMMUNICATIONS SECTION

b6
b7C

Exec. AD-Inv.	
Exec. AD-Adm.	
Exec. AD-LES	
Asst. Dir.:	
Adm. Serv.	
Crim. Inv.	
Ident.	
Intell.	
Laboratory	
Legal Coun.	
Plan. & Insp.	
Rec. Mgnt.	
Tech. Serv.	
Training	
Public Affs. Off.	
Telephone Rm.	
Director's Sec'y	

b6
b7C

TELETYPED TO:

63 NOV 15 1979

OCT 31 1979

RECEIVED
TELETYPE UNIT
BEST AVAILABLE COPY

28 SEP 79 21 45 z

RECEIVED
FEDERAL BUREAU
OF INVESTIGATION
COMMUNICATIONS SECTION

b6
b7C

- Exec. AD-Adm. _____
- Exec. AD-Inv. _____
- Exec. AD-LES _____
- Asst. Dir.:
- Adm. Servs. _____
- Crim. Inv. _____
- Ident. _____
- Intell. _____
- Laboratory _____
- Legal Coun. _____
- Plan. & Insp. _____
- Rec. Mgmt. _____
- Tech. Servs. _____
- Training _____
- Public Affs. Off. _____
- Telephone Rm. _____
- Director's Sec'y _____

0017 2712135

NY NY SF SJ

DE MI

P 082135Z SEPT 79

FM MIAMI [redacted] (P)

TO DIRECTOR PRIORITY

NEW YORK PRIORITY

SAN FRANCISCO PRIORITY

SAN JUAN [redacted] (VIA WASHINGTON) PRIORITY

b3
b6
b7C
b7E

~~CONFIDENTIAL~~

ATTENTION: INTELLIGENCE DIVISION.

[redacted], BUFILE [redacted]

[redacted]

[redacted] BID, [redacted]

PROPOSED VISIT OF CUBAN PREMIER FIDEL CASTRO TO THE UNITED

STATES, OCTOBER 1979; PFC MATTER. (U)

RE MIAMI TEL TO BUREAU, SEPTEMBER 27, 1979, CLASSIFIED

11 OCT 5 1979

~~SECRET~~. (U)

THE FOLLOWING IS A TRANSCRIPT OF AN INTERVIEW OF [redacted]

b6
b7C

[redacted] CONDUCTED ON SEPTEMBER 27, 1979 BY A TV CHANNEL 7 NEWS

28 SEP 58 8 34 AM '100 NOT RECORDED
OCT 11 1979

XEROX
OCT 10 1979

TELETYPE TO:

60 08 1979
55

INTELLIGENCE DIVISION
RECEIVED

UNRECORDED COPY FILED

ORIGINAL FILED IN

PAGE TWO

~~CONFIDENTIAL~~

b3
b7E

REPORTER, MIAMI, FLORIDA: (U)

[REDACTED] "SEVERAL MONTHS AGO, CHANNEL 7 NEWS
DID A REPORT STATING THAT [REDACTED]
MILITANT ANTI-CASTRO ORGANIZATION-ALPHA 66, WAS THE TARGET
OF AN ASSASSINATION ATTEMPT POSSIBLY BY PRO-CASTRO FORCES.

b6
b7C

THE REPORT WAS LATER CONFIRMED BY THE FBI WHO HAD WARNED
[REDACTED] THAT HIS LIFE WAS IN DANGER. LAST WEEK, THE DANGER
MATERIALIZED IN THE FORM OF TWO MEN IN A CAR WITH A 45 CALIBER
RIFLE. THEY TRIED TO GUN DOWN [REDACTED] ON A MIAMI STREET
CORNER AS HE DROVE HOME. A FRAGMENT OF ONE BULLET CAUGHT HIM
JUST ABOVE HIS LEFT TEMPLE. [REDACTED] SAYS HE KNOWS WHY THE
ATTEMPT WAS MADE ON HIS LIFE. IT IS BECAUSE SOMEONE

b6
b7C

LEARNED INFORMATION TO CASTRO AGENTS THAT HE WAS BEHIND A
PLOT TO ASSASSINATE CASTRO UPON THE CUBAN PRESIDENT'S
ANTICIPATED TRIP TO THE UNITED STATES IN NEW YORK ON OCTOBER
5, 1979. YOU SAY THE FBI HAS IMPLICATED YOU IN A PLOT TO
KILL FIDEL CASTRO ON OCTOBER 5. IS THAT TRUE?" (U)

[REDACTED] "(UNINTELLIGIBLE) ANSWER THIS, THIS QUESTION. (U)

b6
b7C

[REDACTED] "YOU CAN'T ANSWER." (U)

PAGE THREE

~~CONFIDENTIAL~~

b3
b6
b7C
b7E

"I HEARD, I HEARD IN MANY, IN MANY PLACES IN THE
(UNINTELLIGIBLE) SUPPOSEDLY I (UNINTELLIGIBLE) PLOTS
AGAINST CASTRO." (U)

"TO KILL CASTRO. A PLOT TO KILL CASTRO IN NEW YORK
ON OCTOBER 5?" (U)

b6
b7C

"YES (UNINTELLIGIBLE) IN HIS VISIT, I HEARD ABOUT." (U)

"DURING HIS VISIT." (U)

"I HEARD ABOUT THAT." (U)

"BUT YOU CAN'T TELL US IF YOU HAD ANY INVOLVEMENT." (U)

"NO. I CAN'T TELL YOU." (U)

b6
b7C

"YOU TRIED TO KILL CASTRO ONCE BEFORE, DID YOU NOT?" (U)

"TWO TIMES." (U)

"TWO TIMES?" (U)

"TWO TIMES. ONE IN CUBA, AND ANOTHER IN CHILE." (U)

"WHAT WILL YOU DO NOW, WHERE WILL YOU GO?" (U)

"I THINK IT'S BEST, THE BEST THING IS TO DISAPPEAR." (U)

b6
b7C

PAGE FOUR

[REDACTED]

~~CONFIDENTIAL~~

b3
b6
b7C
b7E

INVESTIGATING ANTI-CASTRO ACTIVITIES. [REDACTED] HAS NOW COME UNDERGROUND AND IT IS NOT KNOWN WHERE OR WHEN HE WILL SURFACE.

HE SAID HE HAS ASKED THE FBI FOR PROTECTION, BUT SO FAR THEY HAVE NOT RESPONDED TO HIS REQUEST. MEAN WHILE, THE STATE

DEPARTMENT REFUSES TO CONFIRM THAT EDEL CASTRO IS, IN FACT, PLANNING TO MAKE A VISIT TO NEW YORK CITY ON OCTOBER 5; HOW-

EVER, IN ANTICIPATION THAT HE WILL MAKE THAT TRIP, CUBAN EXILES BOTH HERE IN MIAMI AND NEW YORK ARE GEARING UP FOR

MASSIVE DEMONSTRATIONS. [REDACTED] CHANNEL 7 NEWS." (U)

b6
b7C

W.C. & E.E.V. 1357, REASON 2, DRD-SEPTEMBER 28, 1999.

BT

~~CONFIDENTIAL~~

Memorandum to the Director
Re: CAZVIS

At 3:00 p.m. on 10/12/79, SAC Smith contacted DAD O'Malley and advised that he was unable to reach Ambassador McHenry, although he tried several times, because of the Ambassador's heavy schedule. The New York Liaison Agent with the U.S. Mission finally did establish contact and discussed the problem which is as follows:

When Castro arrived at JFK Airport he experienced a one-half hour delay due to the processing procedures engaged in by INS, Customs and the Department of Agriculture at the Airport. Castro complained about this to United Nations Secretary General Waldheim who in turn complained to Ambassador McHenry. The latter sent a teletype to Secretary of State Vance and asked the Department of State to create a more efficient situation at Kennedy Airport regarding courtesies being extended to visiting dignitaries.

Ambassador McHenry indicated that he is very pleased by the fact that the FBI contacted him regarding this teletype although he had not mentioned the FBI at all in his teletype. He stated that the FBI was the only agency to contact him although he has no problem whatsoever with the FBI regarding the Castro visit. He added that there is no need for a meeting with the FBI. Ambassador McHenry was advised that the FBI, however, was willing to meet with him should he decide for any reason that this is necessary. SAC Smith concluded by stating that he intends to pay a courtesy call on Ambassador McHenry following the Castro visit.

I telephonically furnished the above information to you on this date.

- 2 -

~~CONFIDENTIAL~~

NY 271011Z

PP HI NY SF SJ

DE:MM

P 271113Z SEP 79

FM MIAMI [redacted] (P)

TO DIRECTOR PRIORITY

NEW YORK PRIORITY

SAN FRANCISCO PRIORITY

SAN JUAN VIA WASHINGTON PRIORITY

BT

~~SECRET~~

ATTENTION: BUREAU - INTD.

[redacted] : BUREAU FILE [redacted]

[redacted]

[redacted] EID: [redacted]

PROPOSED VISIT OF CUBAN PREMIER FIDEL CASTRO TO THE UNITED STATES OCTOBER, 1979: PFC MATTER.

SECTIONS OF THIS TELETYPE ARE CLASSIFIED ~~SECRET~~ APPROPRIATELY NOTED BELOW.

(U) ~~(S)~~ ON SEPTEMBER 27, 1979, AN OPERATIONAL ASSET WHO HAS FURNISHED RELIABLE INFORMATION IN THE PAST ADVISED AS

185-1241-

NOT RECORDED
100 OCT 10 1979

OCT 5 1979

[redacted]

- Exec. AD-Adm.
- Exec. AD-Inv.
- Exec. AD-LES
- Asst. Dir.:
- Adm. Servs.
- Crim. Inv.
- Ident.
- Insp.
- Laboratory
- Legal Coun.
- Plan. & Insp.
- Rec. Mgmt.
- Tech. Servs.
- Training
- Public Affs. Off.
- Telephone Rm.
- Director's Sec'y

b3
b6
b7C
b7E

b6
b7C

b3
b6
b7C
b7E

ORIGINAL FILED IN

b6
b7C

RECEIVED

97 NOV 2 1979

PAGE FOUR [REDACTED]

~~SECRET~~

b3
b7E

ADMINISTRATIVE:

RE SAN JUAN TELETYPE TO THE BUREAU SEPTEMBER 25, 1979,
MIAMI TELETYPE TO THE BUREAU SEPTEMBER 26, 1979.

OPERATIONAL ASSET IS [REDACTED]

b3
b6
b7C
b7D

ASSET ADVISED THAT HE HAS NOT DEVELOPED ANY INFORMATION
CONCERNING PLAN OF [REDACTED] DURING CASTRO'S VISIT.

IT IS NOTED THAT [REDACTED]

[REDACTED]

MIAMI CONTINUING TO FOLLOW.

SAN FRANCISCO AT SANTA CLARA, CALIFORNIA, IMMEDIATELY
ATTEMPT TO DEVELOP BACKGROUND DATA ON [REDACTED]

b6
b7C

~~C AND E BY 6734, REASONS TWO AND THREE, DDD SEPTEMBER 27,~~

~~END~~

BT

FEDERAL BUREAU OF INVESTIGATION
FOI/PA
DELETED PAGE INFORMATION SHEET
FOI/PA# 1362425-000

Total Deleted Page(s) = 24

- Page 14 ~ Duplicate;
- Page 15 ~ Duplicate;
- Page 16 ~ Duplicate;
- Page 17 ~ Duplicate;
- Page 20 ~ Referral/Direct;
- Page 21 ~ Referral/Direct;
- Page 24 ~ b3; b6; b7C; b7D; b7E;
- Page 25 ~ b3; b6; b7C; b7E;
- Page 27 ~ b3; b6; b7C; b7D;
- Page 63 ~ b6; b7C;
- Page 64 ~ b6; b7C;
- Page 65 ~ b6; b7C;
- Page 66 ~ b6; b7C;
- Page 67 ~ b6; b7C;
- Page 68 ~ b6; b7C;
- Page 69 ~ b6; b7C;
- Page 70 ~ b6; b7C;
- Page 72 ~ b6; b7C;
- Page 73 ~ b6; b7C;
- Page 74 ~ b6; b7C;
- Page 75 ~ b6; b7C;
- Page 77 ~ b6; b7C;
- Page 80 ~ b6; b7C;
- Page 81 ~ b6; b7C;

```
XXXXXXXXXXXXXXXXXXXXXXXXX  
X Deleted Page(s) X  
X No Duplication Fee X  
X For this Page X  
XXXXXXXXXXXXXXXXXXXXXXXXX
```

NY0496 2900138

PP HQ LA MM NK SF HI WF

DE NY 0027

P160026Z OCT 79

FM NEW YORK (185-899)

TO DIRECTOR PRIORITY

LOS ANGELES ROUTINE

MIAMI ROUTINE

NEWARK PRIORITY

SAN FRANCISCO ROUTINE

SAN JUAN ROUTINE (VIA FBIHQ)

WASHINGTON FIELD ROUTINE

BT

UNCLAS

CAZVIZ; PFO; OO: NEW YORK.

REC'D
TELETYPE

17 OCT 79 01 54z

7M-10

Exec. AD-Inv.	_____
Exec. AD-Adm.	_____
Exec. AD-LES	_____
Asst. Dir.:	
Adm. Servs.	_____
Crim. Inv.	_____
Ident.	_____
Intell.	_____
Laboratory	_____
Legal Coun.	_____
Plan. & Insp.	_____
Rec. Mgnt.	_____
Tech. Servs.	_____
Training	_____
Public Affs. Off.	_____
Telephone Rm.	_____
Director's Sec'y	_____

b3
b6
b7C
b7E

UNRECORDED COPY FILED IN

b3
b6
b7C
b7E

185-1241-125

OO: NEW

YORK.

b3
b7E

AS THE BUREAU AND RECIPIENT OFFICES ARE AWARE, FIDEL

CASTRO DEPARTED THE UNITED STATES ON SUNDAY, OCTOBER 14,

1979. NO INCIDENCES OCCURRED AT NEW YORK RELATIVE TO CASTRO'S

VISIT OTHER THAN THOSE SET FORTH IN PREVIOUS COMMUNICATIONS.

NO ACTUAL ASSAULTS ON CASTRO, SECURITY PERSONNEL OR THE CUBAN

b6
b7C

over

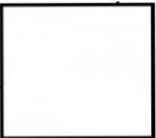

~~NOV 15 1979~~

NOV 21 1979

TELETYPED TO:

OCT 23 1979

[REDACTED] IN NEW YORK.

DURING THE PERIOD OCTOBER 12 THROUGH OCTOBER 13, 1979,

[REDACTED] SOURCE WHO HAS PROVIDED LIMITED
RELIABLE INFORMATION IN THE PAST, [REDACTED]

b6
b7C
b7D

[REDACTED]

DURING A DISCUSSION WITH [REDACTED]

[REDACTED]

b6
b7C
b7D

[REDACTED]

DURING THE ABOVE TIME PERIOD NYO SOURCE ALSO BECAME
FAMILIAR WITH [REDACTED]

[REDACTED]

b6
b7C
b7D

ON SATURDAY, OCTOBER 13, 1979, A CONFIDENTIAL NON-SYMBOL
SOURCE, WITH WHOM CONTACT INSUFFICIENT TO ESTABLISH RELIABILITY,
ADVISED THAT [REDACTED]

[REDACTED]

b6
b7C
b7D

PAGE FIVE U N C L A S

ON SATURDAY, OCTOBER 13, 1979. SOURCE TOLD NYO SPECIAL AGENT

THAT [REDACTED]

b6
b7C
b7D

[REDACTED]

IN ADDITION TO THE ABOVE INDIVIDUALS BEING OBSERVED,
ALSO OBSERVED WERE [REDACTED] WHO WAS USING A GRAY VAN
WHICH WAS REGISTERED TO [REDACTED] AND THE
CUBAN NATIONALIST MOVEMENT USED THIS VAN AS A SOUND TRUCK AND
DURING A SHORT DISCUSSION BETWEEN [REDACTED] AND NYO SPECIAL
AGENTS, [REDACTED] STATED THAT HE BOUGHT THE TRUCK FROM [REDACTED]
AND ALSO [REDACTED] IN NEW YORK CITY. THE
BUREAU AND VARIOUS OTHER OFFICES ARE AWARE OF [REDACTED]

b6
b7C

IN VIEW OF THE FACT THAT NO INCIDENCES OCCURRED AT NEW YORK
RELATIVE TO CASTRO'S VISIT, THE NYO WILL PLACE THIS CASE IN
A CLOSED STATUS BY SEPARATE COMMUNICATION.

ACTIVITIES OF CERTAIN CUBAN EXILES WILL BE FOLLOWED, AS

PAGE SIX U N C L A S

PREVIOUSLY DONE, UNDER THE OMEGA SEVEN CAPTIONED ABOVE.

ON THE AFTERNOON OF TUESDAY, OCTOBER 16, 1979, THE ABOVE
NON-SYMBOL SOURCE TELEPHONICALLY ADVISED THE NYO THAT

b7D

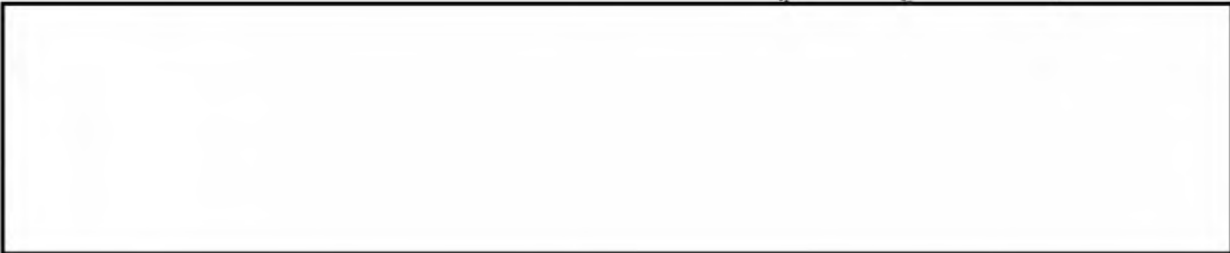

ARMED AND DANGEROUS.

ADMINISTRATIVE:

THE ABOVE NON-SYMBOL SOURCE IS

b6
b7C
b7D

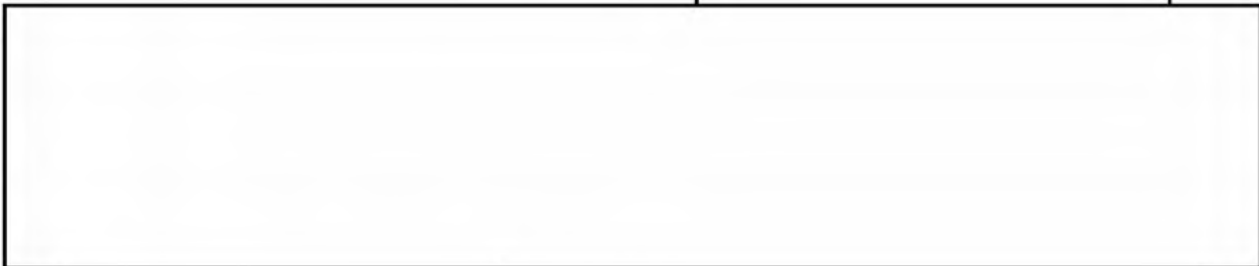

BT

UNITED STATES GOVERNMENT

Memorandum

TO : DIRECTOR, FBI

DATE: 10/19/79

FROM : SAC, CHICAGO (185-217) (RUC) (SQUAD 11)

ECT: CAZVIZ
PFO
OO: NY

b6
b7C

In view that no further investigation is being requested of the Chicago Division in this matter, this case is being RUC'd.

b6
b7C

- ② - Bureau
- 1 - New York
- 1 - Chicago

(4)



185 - 1241 - 126

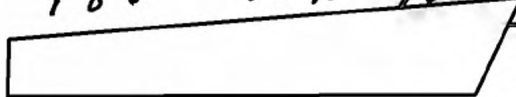

b3
b6
b7C
b7E

OCT 24 1979



1 c/c enc retain
4051



Rec 4052

b6
b7C

NOV 23 1979

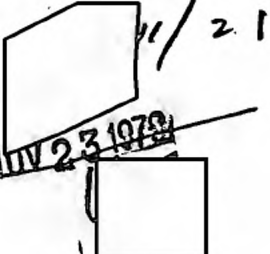

SEARCHED	INDEXED
SERIALIZED	FILED
OCT 19 1979	
FBI-CHICAGO	



Buy U.S. Savings Bonds Regularly on the Payroll Savings Plan

NOV 27 1979



RECEIVED
TELETYPE UNIT

30 OCT 79 1A 42z

RECEIVED
FEDERAL BUREAU
OF INVESTIGATION
COMMUNICATIONS SECTION

Exec. AD-Adm.	
Exec. AD-Inv.	
Exec. AD-LES.	
Asst. Dir.:	
Adm. Serv.	
Crim. Inv.	
Ident.	
Intell.	
Laboratory	
Legal Coun.	
Plan. & Insp.	
Rec. Mgnt.	
Tech. Servs.	
Training	
Public Affs. Off.	
Telephone Rm.	
Director's Sec'y	

b6
b7C

PH0006 276 1832Z

RR HQ NY

DE PH

R 031832Z OCT 79

FM PHILADELPHIA [redacted]

TO DIRECTOR ROUTINE

L.M.
NEW YORK (185-) ROUTINE

b6
b7C
b7D

~~CONFIDENTIAL~~

PROPOSED VISIT OF CUBAN PREMIER FIDEL CASTRO TO THE U.S.; PFO-MATTER

NEW YORK

ON OCTOBER 2, 1979, [redacted] *NY* RELIABLE, REPORTED THAT [redacted]

b3
b6
b7C
b7D

[Large redacted block]

REC-5 185-1241-127

[Redacted line]

[Redacted line]

ST-118

6 OCT 10 1979

C&E 636, RE (2) (3); DRD OCTOBER 3, 1999.

BT

[Redacted block]

b6
b7C

59 NOV 26 1979

R

LOCAL & STATE

b6
b7c

ERROR IN MESSAGE FROM NLETS
 AM.PAPSP9400
 06:54 10/01/79 00433
 07:01 10/01/79 00042 DCFBIWA00
 TXT MSG YKS381 OCT 01 1979 09:50:44
 FILE 15 PAPSP9400 SP YORK [redacted]
 TO: DIRECTOR, BUREAU OF CRIMINAL INVESTIGATION
 ATTN: GENERAL INVESTIGATION DIVISION
 REL: POSSIBLE U.N. VISIT BY CASTRO OR YASSIR ARAFAT
 PLO SOURCES IN THIS AREA REVEALED THAT NO INDIVIDUALS OR GROUPS WOULD PL

FEDERAL BUREAU OF INVESTIGATION
NATIONAL COMMUNICATIONS CENTER

OCT 1 1979

TELETYPE

NCIC

185-1241
FILED IN

TO DEMONSTRATE OR TAX *Fidel Castro*

NY Cuba

ERROR IN MESSAGE FROM NLETS
E PART IN ANY ACTIVITY. PLS ACKNOWLEDGE RECEIPT OF
MESS.

AUTH SP YORK [redacted] LT [redacted] MFC

XEROX

OCT 11 1979

FILED IN

b6
b7c

REC-8

185-1241-128

ST-140

OCT 3 1979

[redacted]

59 DEC 5 1979

b6
b7c

DECLASSIFICATION AUTHORITY DERIVED FROM:
FBI AUTOMATIC DECLASSIFICATION GUIDE
DATE 05-10-2023 BY: [redacted]
MESSAGE RELAY VIA TELETYPE

068
TAP

DATE 12/4/79	CLASSIFICATION CONFIDENTIAL	PRECEDENCE ROUT PRIORITY
-----------------	---	--

FM DIRECTOR FBI

TO
FEDERAL GOVERNMENT

OP 2
3-2

b3
b6
b7C
b7E

(SERVICE ALSO AVAILABLE TO GOVERNMENT AGENCIES NOT LISTED.
CONTACT COMMUNICATIONS CENTER FOR ADDRESSING INFORMATION)
SUBJECT:

REC-8 185-1241-129

OCT 9 1979

BY	ORIGINATOR	ROOM	TELE EXT.
[redacted]	[redacted]	4048	

b6
b7C

60 DEC 03 1979

FEDERAL BUREAU OF INVESTIGATION
COMMUNICATIONS SECTION

OCT 05 1979

0431

DO NOT FILE WITHOUT COMMUNICATIONS STAMP

USE OF FORM 0-73

1. Only incoming teletype messages which require transmission relay may be prepared for transmission using form 0-73. Use of form 0-73 is restricted to incoming teletype messages received within the last 3 days which require transmission relay; all other teletype messages must be prepared using form 0-93.
2. Additions such as notes and administrative data for a specific addressee are not allowed. If a note or administrative data is required for a particular addressee a separate 0-73 form must be prepared.
3. The message will be transmitted just as it appears. The person approving the message is solely responsible for assuring all necessary editing changes have been made.

PREPARATION OF FORM WHICH CONSISTS OF A PREPRINTED YELLOW.

1. Complete appropriate boxes: date, classification & precedence.
2. List addresses immediately following the "TO" or place a check mark in the appropriate boxes.
3. Type or PRINT the subject in the space provided.
4. Print or type originator's name, room number and telephone extension.
5. Indicate approval for transmission by initialing the "Approved By" box.

PREPARATION OF MESSAGE TO BE TRANSMITTED

1. Xerox 1 copy of incoming teletype message. A notation shall be made on the original incoming teletype "1 copy made for relay to SACS _____, (OR LEGATS) _____, (OR GOVERNMENT AGENCIES) _____."
2. Minor editing changes shall be made on the xerox as follows: using a lead pencil ONLY draw single line through the first and last lines of the heading and connect these lines from top right to bottom left forming a "Z," figure. (DO NOT OBLITERATE THE HEADING.) Use horizontal lines to delete sentences or words. Printed changes of a word or two to the text of the message may be made; however, changes to the existing text involving more than a word or two necessitate the originator to initiate a new message using form 0-93.
3. Administrative data or notes may be typed immediately following the text and will be transmitted to all addressees.
4. When using the 0-73 form to disseminate information to field offices, Legal Attaches and other Government agencies simultaneously, the text, notes and administrative data must be identical for all addressees.

RECEIVED
FEDERAL BUREAU
OF INVESTIGATION
COMMUNICATIONS SECTION
OCT 19 4 19 4

O
A
P
[redacted]

MESSAGE RELAY VIA TELETYPE

033

DATE 10/9/79	CLASSIFICATION CONFIDENTIAL CLASSIFIED	PRECEDENCE Priority
-----------------	---	------------------------

FM DIRECTOR FBI

TO FEDERAL GOVERNMENT

[Handwritten signature]

b3
b6
b7C
b7E

[Large redacted area]

(SERVICE ALSO AVAILABLE TO GOVERNMENT AGENCIES NOT LISTED.
CONTACT COMMUNICATIONS CENTER FOR ADDRESSING INFORMATION)

SUBJECT:

[redacted]

REC-8

185-124-130

[redacted]	ROOM 4048	TELE EXT. 4660
------------	--------------	-------------------

b6
b7C

OCT 11 1979

60 DEC 03 1979

FEDERAL BUREAU OF INVESTIGATION
COMMUNICATIONS SECTION
203/2
OCT 09 1979

DO NOT FILE WITHOUT COMMUNICATIONS STAMP

USE OF FORM 0-73

1. Only incoming teletype messages which require transmission relay may be prepared for transmission using form 0-73. Use of form 0-73 is restricted to incoming teletype messages received within the last 3 days which require transmission relay; all other teletype messages must be prepared using form 0-93.
2. Additions such as notes and administrative data for a specific addressee are not allowed. If a note or administrative data is required for a particular addressee a separate 0-73 form must be prepared.
3. The message will be transmitted just as it appears. The person approving the message is solely responsible for assuring all necessary editing changes have been made.

PREPARATION OF FORM WHICH CONSISTS OF A PREPRINTED YELLOW.

1. Complete appropriate boxes: date, classification & precedence.
2. List addresses immediately following the "TO" or place a check mark in the appropriate boxes.
3. Type or PRINT the subject in the space provided.
4. Print or type originator's name, room number and telephone extension.
5. Indicate approval for transmission by initialing the "Approved By" box.

9 OCT 19 18 03
RECEIVED
FEDERAL BUREAU
OF INVESTIGATION
COMMUNICATIONS SECTION

PREPARATION OF MESSAGE TO BE TRANSMITTED

1. Xerox 1 copy of incoming teletype message. A notation shall be made on the original incoming teletype "1 copy made for relay to SACS _____, (OR LEGATS) _____, (OR GOVERNMENT AGENCIES) _____."
2. Minor editing changes shall be made on the xerox as follows: using a lead pencil ONLY draw single line through the first and last lines of the heading and connect these lines from top right to bottom left forming a "Z," figure. (DO NOT OBLITERATE THE HEADING.) Use horizontal lines to delete sentences or words. Printed changes of a word or two to the text of the message may be made; however, changes to the existing text involving more than a word or two necessitate the originator to initiate a new message using form 0-93.
3. Administrative data or notes may be typed immediately following the text and will be transmitted to all addressees.
4. When using the 0-73 form to disseminate information to field offices, Legal Attaches and other Government agencies simultaneously, the text, notes and administrative data must be identical for all addressees.

FBI

TRANSMIT VIA:

- Teletype
- Facsimile
- Airtel

PRECEDENCE:

- Immediate
- Priority
- Routine

CLASSIFICATION:

- TOP SECRET
- SECRET
- CONFIDENTIAL
- UNCLAS E F T O
- UNCLAS

Date 10/22/79

b6
b7C

TO: DIRECTOR, FBI

~~SECRET~~

FROM: SAC, MIAMI (P)

CAZVIZ

PFO
OO: NEW YORK
(Miami File 185-126)

OO: MIAMI

b3
b6
b7C
b7E

This communication is classified ~~Secret~~ in its entirety.

Re Miami teletype to Bureau, 10/15/79.

185-1241-130X1

Enclosed for the Bureau are three copies, and for New York one copy, of a telex [redacted]

b3
b6
b7C
b7D
b7E

For the information of New York, [redacted]

(3- Bureau (Enc. 1) (RM)

~~SECRET~~ 16 OCT 25 1979

- [redacted] (CAZVIZ)
- 1- New York (185-899)(Enc.1)(RM)
- 2- Miami (1- 185-126)

Classified & Extended by 1357
Reason for Extension FCIM II,

Date of Review for Declassification
October 22, 1999

59
Approved

79

Transmitted

(Number)

(Time)

Per

3-REC COPY AND COPY OF ENCL FILED IN

MM 185-126

~~SECRET~~

b3
b6
b7C
b7D
b7E

The enclosed telex is furnished New York for information as it may apply to some phase of an investigation in that office.

2.*

~~SECRET~~

~~CONFIDENTIAL~~



UNITED STATES DEPARTMENT OF JUSTICE
FEDERAL BUREAU OF INVESTIGATION

In Reply, Please Refer to
File No.

Newark, New Jersey

October 31, 1979

VISIT OF CUBAN PREMIER FIDEL CASTRO
TO THE UNITED STATES, OCTOBER, 1979

On October 15, 1979, a confidential, reliable source
advised as follows:

[Large redacted block]

[Redacted line]

(S) (U)

[Redacted block]

[Redacted line]

(S) (U)

b3
b7D

b3
b6
b7C
b7D

~~CONFIDENTIAL~~

~~CLASSIFIED AND EXTENDED BY 953
REASON FOR EXTENSION, FCIM, II, 1-2.4.2(2AND3)
DATE OF REVIEW FOR DECLASSIFICATION
OCTOBER 31, 1999~~

This document contains neither
recommendations nor conclusions of
the FBI. It is the property of
the FBI and is loaned to your agency;
it and its contents are not to be
distributed outside your agency.

185-1241-132

ENCLOSURE

CONFIDENTIAL

FBI

b6
b7C

TRANSMIT VIA:

- Teletype
- Facsimile
- AIRTEL

PRECEDENCE:

- Immediate
- Priority
- Routine

CLASSIFICATION:

- TOP SECRET
- SECRET
- CONFIDENTIAL
- UNCLAS E F T O
- UNCLAS

Date 10/31/79

b6
b7C

TO: DIRECTOR, FBI

FROM: SAC, NEWARK (185-122) (RUC) (HRA)

SUBJECT: CAZVIZ
PFO
(OO: NEW YORK)

2
[redacted] (X)

b6
b7C

Enclosed for the Bureau are five copies, for New York two copies, and for the remaining offices one copy each, of an LHM captioned, "VISIT OF CUBAN PREMIER FIDEL CASTRO TO THE UNITED STATES, OCTOBER, 1979". (C) (U)

The confidential source mentioned herein is

[redacted] (C) (U)

b3
b6
b7C
b7D

CONFIDENTIAL

CLASSIFIED AND EXTENDED BY 953
REASON FOR EXTENSION, FCIM, II, 1-2.4.2(2&3)
DATE OF REVIEW FOR DECLASSIFICATION

10/31/99

ENCLOSURE

- 2 - Bureau (Encs. 5)
- 1 - Boston (Enc. 1) (Info)
- 1 - Los Angeles (Enc. 1) (Info)
- 1 - Miami (Enc. 1) (Info)
- 2 - New York (Encs. 2)
- 1 - San Juan (Enc. 1) (Info)
- 1 - WFO (Enc. 1) (Info)
- 2 - Newark

185-1241-132

7 NOV 5 1979

b3
b6
b7C
b7D
b7E

[redacted] 1 c/c Airtel [redacted] 11/7/79
 (11) 2 c/c enc USSS 11/7/79
 2 c/c enc DOS - security + research 11/7/79
 2 c/c enc [redacted] 11/7/79
 2 c/c [redacted] 11/7/79
 2 c/c enc DOS / OCE 11/7/79

[redacted]

Approve

Transmitted

(Number)

(Time)

Per

DEPARTMENT OF JUSTICE
FEDERAL BUREAU OF INVESTIGATION
COMMUNICATION MESSAGE FORM

b6
b7c

PAGE 1 OF 4

DATE

10/28/79

CLASSIFICATION

~~SECRET~~

PRECEDENCE

ROUTINE

*F*HERR NYDE HQ 40138 *H*YSTER 302242Z OCT 79

▶ START HERE

FM DIRECTOR FBI

TO TO FBI NEW YORK ROUTINE

PERSONAL ATTN: ADIC

14 BT

~~SECRET~~

11 CAZVIZ; PFO-MATTER; 00: NEW YORK

RE FBIHQ TELETYPES SEPTEMBER 21 AND OCTOBER 4, 1979, AND
10 NYO TELETYPE OCTOBER 5, 1979, CAPTIONED "PROPOSED VISIT OF
CUBAN PREMIER FIDEL CASTRO TO THE UNITED STATES, OCTOBER, 1979:
8 PFO MATTER". ~~(S)~~ (U)

BY RE SEPTEMBER 21, 1979, TELETYPE YOU WERE FURNISHED
6 PARAPHRASED INFORMATION AS FURNISHED TO U.S. SECRET SERVICE
USSS} CONCERNING A PLOT TO KILL FIDEL CASTRO. YOU WERE
4 SPECIFICALLY TOLD THAT SHOULD USSS WISH TO DISCUSS MATTER WITH
YOU, NO OTHER INFORMATION SHOULD BE DISCUSSED. THIS CAVEAT
2 WAS SET FORTH IN ORDER TO ENSURE PROTECTION OF A SENSITIVE AND
VALUABLE ASSET OF THIS BUREAU. BY TELETYPE DATED OCTOBER 4,

DO NOT TYPE MESSAGE BELOW THIS LINE

DO NOT TYPE PAST THIS LINE

[redacted]	DATE	ROOM	TELE EXT.
[redacted]	10/28/79	4147/5	4605

[redacted]

SEE NOTE PAGE 5
185-1241-133

ROUTE IN ENVELOPE

b6
b7c

RO DEC 26 1979

[redacted]

FEDERAL BUREAU OF INVESTIGATION
COMMUNICATIONS SECTION
OCT 31 1979

[redacted]

OCT 31 1979

DO NOT FILE WITHOUT COMMUNICATIONS STAMP

DEPARTMENT OF JUSTICE
 FEDERAL BUREAU OF INVESTIGATION
 COMMUNICATION MESSAGE FORM

PAGE 2

CONTINUATION SHEET

PAGE AT WORDS HQ 0138 ~~SECRET~~

1979, YOU WERE ADVISED IT HAD COME TO ATTENTION OF FBIHQ THAT
 20 DETAILS RE OUR ASSET'S REPORTING ON THIS PLOT WERE IN
 18 POSSESSION OF USSS AND THAT THIS INFORMATION HAD BEEN RECEIVED
 BY THE NEW YORK OFFICE OF USSS. BY YOUR TELETYPE OCTOBER 5,
 16 1979, YOU ADVISED YOU HAD DISCUSSED THE PLOT TO KILL CASTRO
 WITH USSS. AS RESULT OF SUBSEQUENT CONTACT WITH USSSHQ IT
 14 HAS BEEN DETERMINED THAT SENSITIVE INFORMATION FURNISHED BY OUR
 ASSET HAD BEEN FURNISHED TO THEM VIRTUALLY VERBATIM FROM
 12 VARIOUS FBI TELETYPES. ~~CS~~ U

BY RE TELETYPE OCTOBER 5, 1979, YOU ADVISED YOU MADE
 10 DECISION TO FURNISH INFORMATION RE THIS PLOT TO USSS IN VIEW
 OF "IMMEDIATE THREAT MADE BY CUBAN EXILES WHO TRAVELED TO
 8 NEW YORK" AS USSS HAD RESPONSIBILITY FOR PROTECTION OF FIDEL
 CASTRO. IT IS NOTED THAT AT THAT TIME NO CONFIRMATION OF
 6 CASTRO'S VISIT HAD BEEN RECEIVED AND YOUR DECISION TO FURNISH
 SENSITIVE INFORMATION TO USSS WAS MADE PRIOR TO THE
 4 OCTOBER 5, 1979, NOTIFICATION OF CASTRO'S VISIT. FBIHQ FULLY
 APPRECIATES YOUR CONCERN OVER POSSIBLE TERRORIST ACTIONS
 2 DURING THE PROPOSED VISIT OF FIDEL CASTRO. HOWEVER, IN VIEW
 OF THE SENSITIVITY OF THE ASSET [REDACTED] A

DO NOT TYPE MESSAGE BELOW THIS LINE

DO NOT TYPE PAST THIS LINE

b3
b7D

~~SECRET~~

PAGE 5

NOTE:

As stated above, New York disseminated sensitive information re possible plot to kill Castro furnished by [redacted] to USSS without approval of FBIHQ. FBIHQ had advised New York, and other offices receiving information furnished by [redacted] of limited dissemination made to USSS on 9/21/79 and of strict caveat on dissemination of information. Dissemination made was brought to attention of FBIHQ by Miami Office on 10/2/79, when Miami agents viewed USSS Miami teletypes from USSS New York which included detailed information reported by the asset. This dissemination was made prior to any information of Castro's arrival, [redacted]

b3
b7D
b7E

[redacted] Subsequent verification of USSS receipt of verbatim information reported by our asset was made on 10/8/79, during briefing of USSSHQ Supervisors at FBIHQ re this matter. USSS teletypes containing this information were viewed by an FBIHQ Supervisor. This briefing was held, as previously planned by INTD and CID, after it was known Castro was actually coming to the United States.

[redacted]

[redacted] NYO advised per above. (S) (U)

[redacted]

b6
b7C

~~SECRET~~

APPROVED:

Director _____
Exec. AD-Inv. _____
Exec. AD-Adm. _____
Exec. AD-LES _____

Adm. Serv. [redacted]
Crim. Inv. [redacted]
Ident. [redacted]
Intell. [redacted]
Lab. [redacted]

Legal Coun. _____
Plan. & Insp. _____
Rec. Mgmt. _____
Tech. Servs. _____
Training _____
Public Affs. Off. _____

b6
b7C

FEDERAL BUREAU OF INVESTIGATION

Washington, D. C. 20537

b6
b7C



REPORT of the LATENT FINGERPRINT SECTION IDENTIFICATION DIVISION

YOUR FILE NO. 185-899 (M-10)
FBI FILE NO. 185-1241-
LATENT CASE NO. 3-79003

November 29, 1979

b3
b6
b7C
b7E

TO: ADIC, New York

~~SECRET~~



11-17-2000

CLASSIFIED BY: [redacted]
REASON: 1.5 (e, 1)
DECLASSIFY ON: X
903328

RE: ~~CAZYIA~~
PFO

~~ALL INFORMATION CONTAINED
HEREIN IS UNCLASSIFIED EXCEPT
WHERE SHOWN OTHERWISE~~

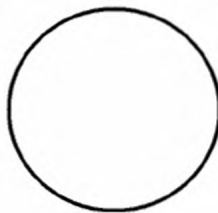

149-12720-
[redacted]

UNRECORDED COPY FILED IN

b6
b7C

REFERENCE: Teletype 10-13-79
EXAMINATION REQUESTED BY: New York
SPECIMENS:

MAILED 10
NOV 30 1979
FBI

Based on the information furnished, no record was located in the Identification Division files for [redacted]

185-1241-134 (S)

The two latent fingerprints previously reported in Bufile #149-12720, your file #149-3930 (P) (M-10), our latent case #B-72920, and eighteen latent fingerprints previously reported in Bufile [redacted], your file #185-796 (#214) (P), [redacted] were compared with the fingerprints of [redacted] FBI [redacted] without effecting an identification.

b3
b6
b7C
b7E

Two latent fingerprints, which were made by the tip

(Continued on next page)

- Assoc. Dir. _____
- Dep. AD Adm. _____
- Dep. AD Inv. _____
- Asst. Dir.:
- Adm. Servs. 2 - New York (149-3930) (P) (M-10) (1 - 185-796) - (#214) - (P)
- Crim. Inv. 2 - Newark [redacted]
- Ident. _____
- Intell. _____
- Laboratory 1 - Bufile (149-12720)
- Legal Coun. 1 - Bufile [redacted]
- Plan. & Insp. 1 - Bufile [redacted]
- Rec. Mgnt. _____
- Tech. Servs. _____
- Training _____
- Public Affs. Off. _____
- Telephone Rm. _____
- Director's Sec'y _____

7 NOV 30 1979

~~SECRET~~

b3
b6
b7C
b7E

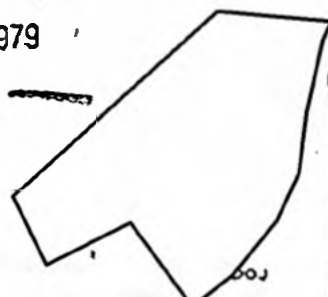

(12) THIS REPORT IS FURNISHED FOR OFFICIAL USE ONLY

MAIL ROOM [redacted]

ADIC, New York

~~SECRET~~

November 29, 1979

~~SECRET~~
or side areas of fingers, previously reported in latent case #B-66597 were compared with the fingerprints of Gonzalez, but no identification was effected. Inked impressions of the tips and sides of the fingers of this individual are needed for conclusive comparisons.

No latent prints of value have previously been reported in Bufile [redacted]

and Bufile [redacted]

b3
b7E

~~SECRET~~
~~SECRET~~

FEDERAL BUREAU OF INVESTIGATION
LATENT FINGERPRINT SECTION WORK SHEET

Recorded: 10/16/79

8:35 a.m.

Reference No: 185-899 (M-10)

Received: 10/16/79

FBI File No: 185-1241

Latent Case No: B-79003

Answer to: ADIC, New York

Examination requested by: Addressee

Copy to:

RE: CAZVIZ;
PFO

Date of reference communication: Teletype 10/13/79

Specimens: Named Suspects:



Compare the fingerprints of the above Named Suspects with
latents developed in cases entitled: and w.l.
UNSUBS, AKA "OMEGA 7"; BOMBING OF TRANS WORLD AIRLINE TERMINAL,
JFKIA, NEW YORK, 3/25/79, DAMV
Bufile #149-12720, ADIC, New York (149-3930)(P)(M-10), LC# B-72920

Bufile [redacted] ADIC, New York (185-796)(#214)(P), [redacted]

Result of examination:

Examination by: [redacted]

Evidence noted by:

10/17/79

names to

No prev. exp. for lat exam rept case.
10/26/79

no record

Request for [redacted] on [redacted]

[redacted] on locate

b3
b6
b7C
b7E

cc: Bufile 149-12720, NY 149-3930 (P)(M-10)
" [redacted] NY 185-796 (#214) (P)

Examination completed 2:30pm

11/21/79

Dictated 11/21/79

OVER

11-29-79



11/21/79

[Redacted]

b6
b7C

2 lat fprints OK. prev. rept. in te # B-72920

Lat fprints not a fprints

[Redacted]

20 lat fprints (2 made by [Redacted] or sides) prev. rept in

[Redacted]

14 lat fprints not a fprints

[Redacted]

the 2 lat fprints made by top or sides was comp w/ fprints without effect on D.

[Redacted]

No lat fprints OK. prev. rept in

[Redacted]

b3
b6
b7C
b7E

b3
b7E

SEARCHED

SEP

NOV 1979

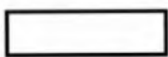

LC #B-79003

Compare the fingerprints of the above Named Suspects with latents developed in captioned case and with latents developed in cases entitled:

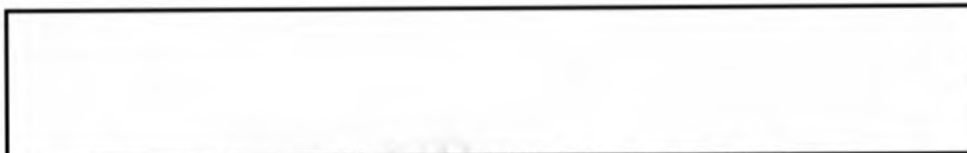

b3
b6
b7C
b7E

[Redacted]

(Legal Counsel Div.)

[Redacted]

December 19, 1979

[Redacted]

b6
b7C

Honorable S. William Green
House of Representatives
Washington, D. C. 20515

Dear Congressman Green:

[Redacted]

b6
b7C

The attached letter of [Redacted] of New York City, was referred to the FBI by the Department of Justice for a response.

Premier Fidel Castro of Cuba visited the United Nations in New York City, during the period October 11-15, 1979. [Redacted] according to his stationery, lives at [Redacted]

b6
b7C

The Cuban Mission to the United Nations, at which Premier Castro resided during his visit to the United Nations, is located at 315 Lexington Avenue, New York City.

b6
b7C

It is, therefore, possible that Cuban security officers were in the vicinity of [Redacted] residence on October 12, 1979, in line with their assigned duties in connection with Premier Castro's security. Should you desire further information regarding this matter you may wish to contact U. S. Secret Service since they provided security and protection for Premier Castro during his visit to the United Nations in October, 1979.

Sincerely yours,

Francis M. Mullen, Jr.

Francis M. Mullen, Jr.
Assistant Director
Criminal Investigative Division

b6
b7C

Enclosure

1 - The Attorney General (Enclosures - 4)
Attention: [Redacted]

[Redacted] (9)

SEE NOTE ON PAGE 2

[Redacted]

b6
b7C

60 JAN 28 1980

MAIL ROOM

FBI/DOJ

MAILED 11
DEC 19 1979
FBI

2- [Redacted]

185-1241

135

DEC 19 1979

401050

MAILED 11
DEC 19 1979
FBI

Honorable S. William Green

NOTE:

A letter was received by Congressman S. William Green
from a [REDACTED]
complaining about armed Cuban secret police at his place.

b6
b7c



b6
b7C

[Redacted]
October 12, 1979

S. William Green
The House of Representatives
Washington, D.C. 20515

Dear Mr. Green:

You're well placed to know the answer to this question, and I hope you or your staff can send me the answer so I won't lie awake nights trying to puzzle it out. Briefly, since when are American citizens living in New York subject to surveillance by armed agents of the Cuban secret police? There's one on guard right now just outside the door to my apartment building, and it scares the hell out of me. The hulking New York cop on duty in the lobby says it scares the hell out of him.

No doubt there's a paragraph somewhere in the Constitution that says American citizens are chattels whose lives may be mortgaged to foreign powers, but I haven't been able to find it. Can you tell me which Article to look at? Or is it in the Bill of Rights?

Yours,

[Redacted signature]

b6
b7C

185-1241-135

ENCLOSURE

ROUTING AND TRANSMITTAL SLIP

Date 11/14

TO: (Name, office symbol, room number, building, Agency/Post)		Initials	Date
1.	[Redacted]		
2.			
3.			11/15
4.			
5.			

Action	[Redacted]	Note and Return
Approval	[Redacted]	Per Conversation
As Requested	[Redacted]	Prepare Reply
Circulate	[Redacted]	See Me
Comment	[Redacted]	Investigate
Coordination	[Redacted]	Justify

b6
b7C

b6
b7C

REMARKS

This clever constituent appears to be referring to security for Castro's visit. FBI agent [Redacted] (324-4605) suggests referring to Bureau's Legal Counsel Division. Thank.

b6
b7C

[Redacted]

DO NOT use this form as a RECORD of approvals, concurrences, disposals, clearances, and similar actions

FROM: (Name, org. symbol, Agency/Post)	Room No.—Bldg.
[Redacted] ATTORNEY	[Redacted]
OLSS CRIMINAL	Phone No.
300 ETB 724 6656	[Redacted]

OPTIONAL FORM 41 (Rev. 7-76)
Prescribed by GSA
FPMR (41 CFR) 101-11.206

b6
b7C

5041-102

FBI

8 10 AM '79

U.S. MAIL
Congress of the United States
House of Representatives
Washington, D.C.

RECEIVED
October 26 1979

NOV 7 1979 RECEIVED

O.I. NOV 10 1979

61X [Redacted]

The attached communication is sent for your consideration. Please investigate the statements contained therein and forward me the necessary information for reply, returning the enclosed correspondence with your answer.

Yours truly, [Redacted]

NOV 13 1979

RECEIVED

CRIMINAL DIVISION NOV 7 1979

Attention: [Redacted]

O.R.O.M.

OFFICE OF LEGISLATIVE AFFAIRS

CRIMINAL

Rec Unit 4: Internal Security, Inc.

Exec. AD-Inv.	_____
Exec. AD-Adm.	_____
Exec. AD-LES	_____
Asst. Dir.:	
Adm. Servs.	_____
Crim. Inv.	_____
Ident.	_____
Intell.	_____
Laboratory	_____
Legal Coun.	_____
Plan. & Insp.	_____
Rec. Mgnt.	_____
Tech. Servs.	_____
Training	_____
Public Affs. Off.	_____
Telephone Rm.	_____
Director's Sec'y	_____

b6
b7C

b6
b7C

185-1241-135

ENCLOSURE

FROM CONG S. WILLIAM GREEN	DATE OF DOCUMENT 10/26/79	SUSPENSE DATE 11/23/79 12/3/79
TO Justice	DATE RECEIVED 11/7/79	CONTROL NO. 4596
DESCRIPTION Let re <input type="text"/>	REFERRED TO	DATE
	CRIMINAL	11/8/79
	FBI	11/16/79
REMARKS PLEASE RETURN COPY OF REPLY AND THIS FORM TO CIA ROOM 1607, EXT. 4501	PREPARE REPLY FOR SIGNATURE OF	
	CRIMINAL FBI	

MAIL CONTROL

REPLACES AO-820 WHICH MAY BE USED
 D.J-295 7-6-73

b6
 b7c



FEDERAL BUREAU OF INVESTIGATION

Washington, D. C. 20537

REPORT

of the

LATENT FINGERPRINT SECTION IDENTIFICATION DIVISION

YOUR FILE NO. 185-1009
FBI FILE NO. 185-1426
LATENT CASE NO. B-91125

November 21, 1980

TO: ADIC, New York

RE: GARMUR;
PFO - MURDER

CAVIZ

b6
b7c

REFERENCE: Airtel 10-27-80
EXAMINATION REQUESTED BY: New York
SPECIMENS:

To date, no evidence has been received for a latent print examination in Bufile #185-747, your file #185-540.

No latent prints have previously been reported in the following cases:

185-1241

[Redacted]

b3
b7E

(Continued on next page)

Enc.

DEC 9 1980

5 - [Redacted] (1 - 149-3930) (1 - 185-899) (1 - 185-953)
(1 - 185-540)

b3
b6
b7C
b7E

10 - [Redacted] (1 - 183-1020)

1 - WFO (185-425)

1 - [Redacted]

2 - [Redacted]

DUPLICATE YELLOW

heat as yellow

Note: 30 files listed on following page.

THIS REPORT IS FURNISHED FOR OFFICIAL USE ONLY

(42)

MAIL ROOM

49

185-1426-206

ORIGINAL FILED IN



001

- 1 - Bufile [redacted]
- 1 - Bufile (149-12710)
- 1 - Bufile [redacted]
- 1 - Bufile [redacted]
- 1 - Bufile [redacted]
- 1 - Bufile (183-3517)
- 1 - Bufile [redacted]
- 1 - Bufile [redacted]
- ① - Bufile (185-1241)
- 1 - Bufile (185-1352)
- 1 - Bufile (185-747)
- 1 - Bufile [redacted]
- 1 - Bufile [redacted]
- 1 - Bufile [redacted]
- 1 - Bufile [redacted]
- 1 - Bufile [redacted]
- 1 - Bufile (185-789)
- 1 - Bufile (185-470)
- 1 - Bufile [redacted]

b3
b7E

b3
b7E

ADIC, New York

November 21, 1980

[REDACTED]

Bufile #183-3517, Newark file #183-1020, our latent case #B-84217

[REDACTED]

Bufile #185-1241, your file #185-899, our latent case #B-79003

[REDACTED]

Four latent fingerprints previously reported in the captioned case: three latent fingerprints previously reported in Bufile [REDACTED] the latent fingerprint in Bufile [REDACTED]

[REDACTED] two latent fingerprints in Bufile #185-789, WFO file #185-425, our latent case #B-37443; the latent impressions in Bufile [REDACTED] and eight latent fingerprints and the six latent impressions in Bufile [REDACTED] were compared, insofar as possible, with the fingerprints of [REDACTED] but no identification was effected.

The remaining latent prints previously reported and remaining unidentified in these cases and in the remaining cases whose titles are on the attached list, are not the fingerprints of [REDACTED] for whom no palm prints are available. Major case prints of this individual are needed for conclusive comparisons.

[REDACTED] is assigned FBI [REDACTED]

b3
b7E

b3
b6
b7C
b7E

b6
b7C



FEDERAL BUREAU OF INVESTIGATION

Washington, D. C. 20537

REPORT

of the

LATENT FINGERPRINT SECTION IDENTIFICATION DIVISION

[Redacted]

YOUR FILE NO.
FBI FILE NO.
LATENT CASE NO.

[Redacted]

May 27, 1980

TO: SAC, Newark

RE:

[Redacted]

CAZVIZ

REFERENCE: Teletype 4/29/80
EXAMINATION REQUESTED BY: Newark
SPECIMENS:

Three latent fingerprints, which were made by the tip or side areas of fingers, previously reported in the captioned case were compared with the fingerprints of

[Redacted] but no identification was effected. The remaining latent fingerprints previously reported in the captioned case and in Bufile #149-12710, New York #149-3930, our latent case #B-72920; Bufile [Redacted]

and in Bufile #185-1352, New York #185-953, our latent (Continued on next page)

4 - New York (149-3930) [Redacted] (1 - 185-899) (1 - 185-953) - Enc.

4 - [Redacted] (1 - 183-1020) [Redacted] - Enc.

2 - [Redacted]
1 - Miami (185-100) - Enc.

1 - Bufile (149-12710)

1 - Bufile [Redacted]

1 - Bufile (183-3517)

1 - Bufile [Redacted]

1 - Bufile (185-1352)

1 - Bufile

1 - Bufile

1 - Bufile

(1) - Bufile (185-1241)

185-1241-

NOT RECORDED
MAY 29 1980

[Redacted] (23)

MAIL ROOM

THIS REPORT IS FURNISHED FOR OFFICIAL USE ONLY.

59 JUN 6 1980

b3
b6
b7C
b7E

ORIGINAL FILED

b3
b6
b7C
b7E

b3
b6
b7C
b7E

FBI/DOJ

b6
b7C

SAC, Newark

May 27, 1980

case #B-84819, are not the fingerprints of [redacted] Major case prints of [redacted] are needed for conclusive comparisons.

b6
b7C

No latent prints have previously been reported in the following cases:

[redacted]

Bufile #183-3517, Newark #183-1020, our latent case #B-84217

b3
b7E

[redacted]

Bufile #185-1241, New York #185-899, our latent case #B-79003

A copy of the identification record of [redacted] is enclosed to Newark, New York and Miami Divisions, as requested.

b6
b7C

Page 2

[redacted]

b3
b7E

b6
b7C
A

UNITED STATES GOVERNMENT

UNITED STATES DEPARTMENT OF JUSTICE
FEDERAL BUREAU OF INVESTIGATION

Memorandum

~~CONFIDENTIAL~~ ~~SECRET~~

TO : DIRECTOR, FBI

DATE: APR 17 1980

FROM : *MJD* ADIC, NEW YORK [redacted]

SUBJECT: VISIT OF CUBAN PREMIER
FIDEL CASTRO TO THE US
[redacted]

6-17-86
Classified by [redacted]
Declassify on: OADR

b3
b6
b7C
b7E

Enclosed for FBIHQ are five (5) copies of an LHM, dated and captioned as above. (U)

Enclosed communication is a compilation of information furnished by US INS on individuals who traveled to NY in connection with the captioned visit. *(e) (S) (U) per INS letter dated 1-13-87*

As indicated in enclosed LHM, NYO has determined that [redacted] There is no indication that any of the others listed still remain in NYC. *(e) (S) (U)*

b3
b6
b7C
b7E

NYO will be alert for any information about the presence of these individuals but otherwise will conduct no further investigation in this matter. *(e) (S) (U)*

ALL INFORMATION CONTAINED
HEREIN IS UNCLASSIFIED
EXCEPT WHERE SHOWN
OTHERWISE

Photo
CC TO [redacted]
REQ. REC'D [redacted]
JAN 4 1982
ANS BY [redacted]

b6
b7C

~~CONFIDENTIAL~~

Classified and Extended by 3441
Reason for Extension FCIM, II, 1-2.4.2 2 & 3
Date of Review for Declassification APR 2000

ENCLOSURE V-48

1 - Bureau (Enc. 35) (RM)
1 - New York [redacted]

Jose DE-49 185-1241-136
SP110

(3)

9 APR 21 1980

b6
b7C

~~SECRET~~



59 MAY 20 1980 Savings Bonds Regularly on the Payroll Savings Plan

[redacted]



~~CONFIDENTIAL~~

UNITED STATES DEPARTMENT OF JUSTICE

FEDERAL BUREAU OF INVESTIGATION

New York, New York

~~SECRET~~

In Reply, Please Refer to
File No.

APR 17 2000

~~ALL INFORMATION CONTAINED
HEREIN IS UNCLASSIFIED
EXCEPT WHERE SHOWN
OTHERWISE~~

b3
b6
b7C
b7E

Visit of Cuban Premier
Fidel Castro to the
United States, October, 1979

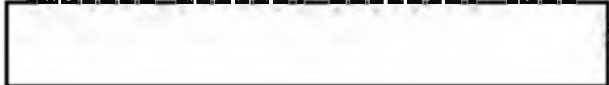

6-12-86
Classified by
Declassify on: OADR

(S) (U)

The Cuban Premier Fidel Castro Ruiz traveled to New York City (NYC) for four days in October, 1979, in order to address the United Nations (UN) General Assembly as the head of the non-aligned conference. The Government of Cuba (GOC) advised United States Department of State (USDS) of the identities of 243 GOC officials who would accompany Castro during his visit. A review of the records of the United States Immigration and Naturalization Service (US INS) determined that 299 GOC officials traveled to New York (NY) between October 4, 1979 and October 11, 1979. Included in this number were 24 individuals who names were not furnished to USDS prior to their arrival. (e) (X)(2) Rev INS letter dated 1-13-87

b6
b7C

Of the group that arrived, no record of departure could be located for ten individuals:

3/18/87
(S) (U)

~~CONFIDENTIAL~~

~~Classified and Extended by 3441
Reason for Extension FCIM, II, 1-2.4.2 2 & 3
Date of Review for Declassification APR 17 2000~~

This document contains neither recommendations nor conclusions of the Federal Bureau of Investigation (FBI). It is the property of the FBI and is loaned to your agency; it and its contents are not to be distributed outside your agency.

185-1241-136

~~SECRET~~

ENCLOSURE

~~CONFIDENTIAL~~

~~SECRET~~

Visit of Cuban Premier
Fidel Castro to the US,
October, 1979

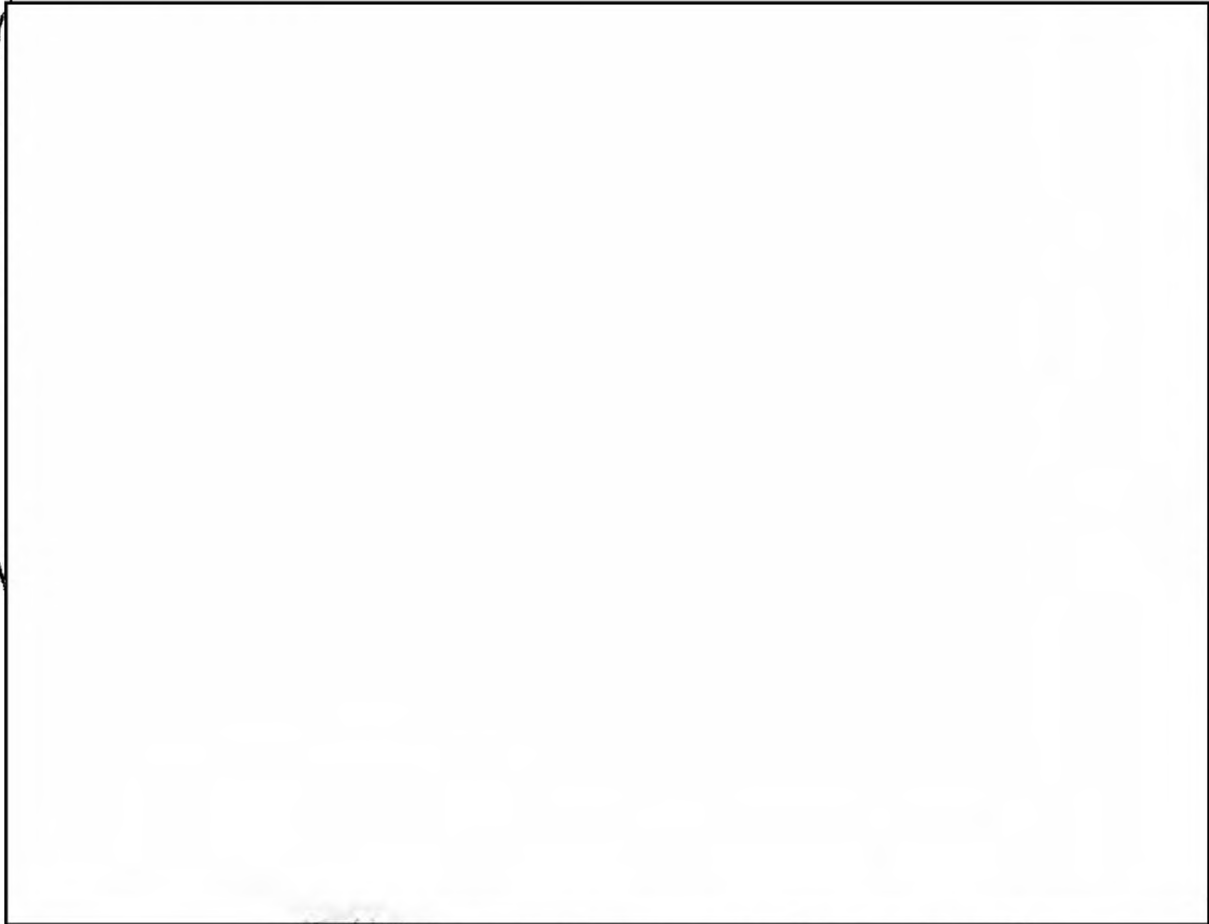

b6
b7C

Investigation by NYO has determined that [redacted]

[redacted] No information has been developed indicating that any of the remaining nine are still in NYC. (C) (S) (U)

b6
b7C

~~CONFIDENTIAL~~

~~SECRET~~

~~CONFIDENTIAL~~

~~SECRET~~

Visit of Cuban Premier
Fidel Castro to the US,
October, 1979

Records of US INS also revealed that seven individuals made several trips to and from Cuba during the period of October 7 through 14, 1979. These individuals are as follows:

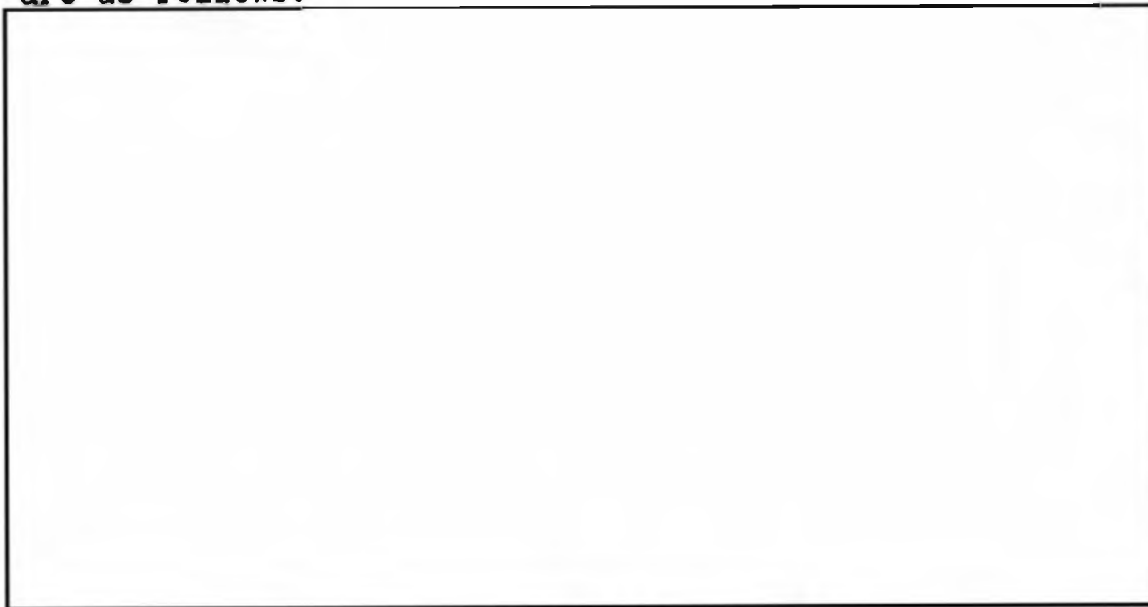

b6
b7C

(S) U

In addition to GOC officials, it was also determined that two US persons, [redacted] date of birth [redacted]

[redacted] arrived on the flight with Castro. [redacted] are associated with the Downtown Community Television Center in NYC. [redacted] filmed and narrated an hour long television documentary called "Cuba the People" aired by Public Broadcasting Service in NYC in December, 1974. It should be noted that [redacted] also departed the US with the GOC entourage on October 14, 1979 with a listed destination of Havana, Cuba. (S) (S) U

b6
b7C

*Rev Ins letter
2/11/87*

~~CONFIDENTIAL~~

~~SECRET~~



FEDERAL BUREAU OF INVESTIGATION

Washington, D. C. 20537

REPORT

of the

LATENT FINGERPRINT SECTION IDENTIFICATION DIVISION

YOUR FILE NO.
FBI FILE NO.
LATENT CASE NO.

[Redacted]

185-1062

November 28, 1980

TO: ADIC, New York

0-7

b3
b6
b7C
b7E

RE:

[Redacted]

Telephone request from Criminal Investigative
Division on 5/5/80

REFERENCE: Division on 5/5/80
EXAMINATION REQUESTED BY: Bureau
SPECIMENS:

To date, no evidence has been received in the
Latent Fingerprint Section for a latent print examination
in Bufile #183-747, your file #185-540.

No latent prints have previously been reported
in the seven cases on List A whose titles are preceded by
an asterisk.

- Enc. (2) (Continued on next page)
- 13 - [Redacted] - Enc. (2) [Redacted] - Enc. (2)
 - (1 - 185-112) - Enc. (2) [Redacted] - Enc. (2)
 - [Redacted] - Enc. (2) (1 - 183-1020) - Enc. (2)
 - [Redacted] - Enc. (2) [Redacted] Enc. (2)
 - [Redacted] - Enc. (2) [Redacted] - Enc. (2)
 - (1 - 185-73) - Enc. (2) [Redacted] - Enc. (2)
 - [Redacted] - Enc. (2)
 - 6 - New York (185-899) - Enc. (2) (1 - 185-540) - Enc. (2)
 - (1 - 149-3930) - Enc. (2) (1 - 189-576) - Enc. (2)
 - (1 - 185-953) - Enc. (2) (1 - 185-1009) - Enc. (2)
 - 3 - [Redacted] - Enc. (2) [Redacted] - Enc. (2)
 - [Redacted] - Enc. (2)
 - 1 - San Francisco (185-120) - Enc. (2)
 - 1 - WFO (185-425) - Enc. (2)
 - 1 - SA [Redacted], Room 4052, TL #242 - Enc. (2)

Note: Bufiles listed on following page)

[Redacted]

NOT RECORDED
38 DEC 11 1980

b3
b6
b7C
b7E

THIS REPORT IS FURNISHED FOR OFFICIAL USE ONLY

DUPLICATE YELLOW

69 DEC 16 1980

ORIGINAL FILED IN 185-1062-41

Handwritten signature

- 1 - Bufile (149-12710)
- 1 - Bufile [redacted]
- 1 - Bufile [redacted]
- 1 - Bufile [redacted]
- 1 - Bufile (183-3517)
- 1 - Bufile [redacted]
- 1 - Bufile [redacted]
- 1 - Bufile [redacted]
- 1 - Bufile [redacted]
- 1 - Bufile (185-789)
- 1 - Bufile [redacted]
- 1 - Bufile [redacted]
- ① - Bufile (185-1241)
- 1 - Bufile (185-1352)
- 1 - Bufile (185-747)
- 1 - Bufile (185-470)
- 1 - Bufile [redacted]
- 1 - Bufile (185-1426)

b3
b7E

ADIC, New York

November 28, 1980

The latent prints previously reported and remaining unidentified in the captioned case and in the remaining cases on List A, were compared with the major case prints of the twenty-two individuals whose names are preceded by an asterisk on List B, and with the fingerprints of the other persons named on List B, for whom no palm prints are available, without effecting an identification. Major case prints of the persons whose names are not preceded by an asterisk are needed for conclusive comparisons.

List A and List B are enclosed.

Page 2



b3
b7E

LIST A

UNSUBS., AKA
"OMEGA 7";
BOMBING OF TRANS WORLD AIRLINE
TERMINAL, JFKIA, NEW YORK
3/25/79; DAMV

Bufile #149-12710
LC #B-72920

ADIC, New York (149-3930)

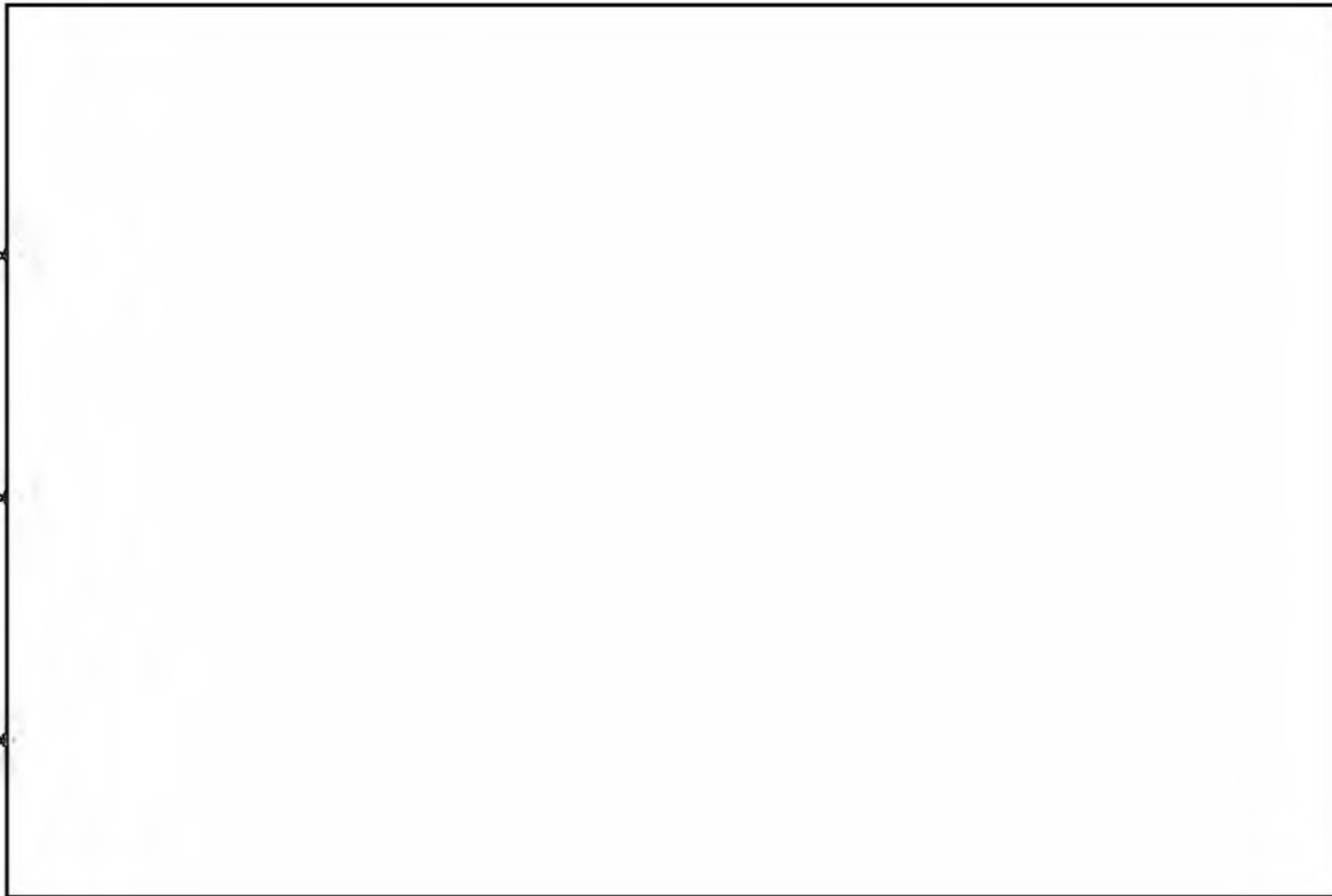

b3
b7E

(* indicates no latent prints previously reported)

b3
b6
b7C
b7E

CAVIZ;
PFO

Bufile #185-1241
LC #B-79003

ADIC, New York (185-899)

UNSUBS., AKA
OMEGA 7;
ATTEMPTED BOMBING ASSASSINATION
OF RAUL ROA-KOURI, CUBAN AMBASSADOR
TO THE UNITED NATIONS
NEW YORK, NEW YORK
3/25/80
PFO-ATTEMPTED MURDER-EID

Bufile #185-1352
LC #B-84819

ADIC, New York (185-953)

UNSUB.; BOMBING OF CUBAN MISSION TO THE U.N.
6 EAST 67TH STREET, NEW YORK, NEW YORK
6/6/76; PFO; EID

Bufile #185-747

ADIC, New York (185-540)

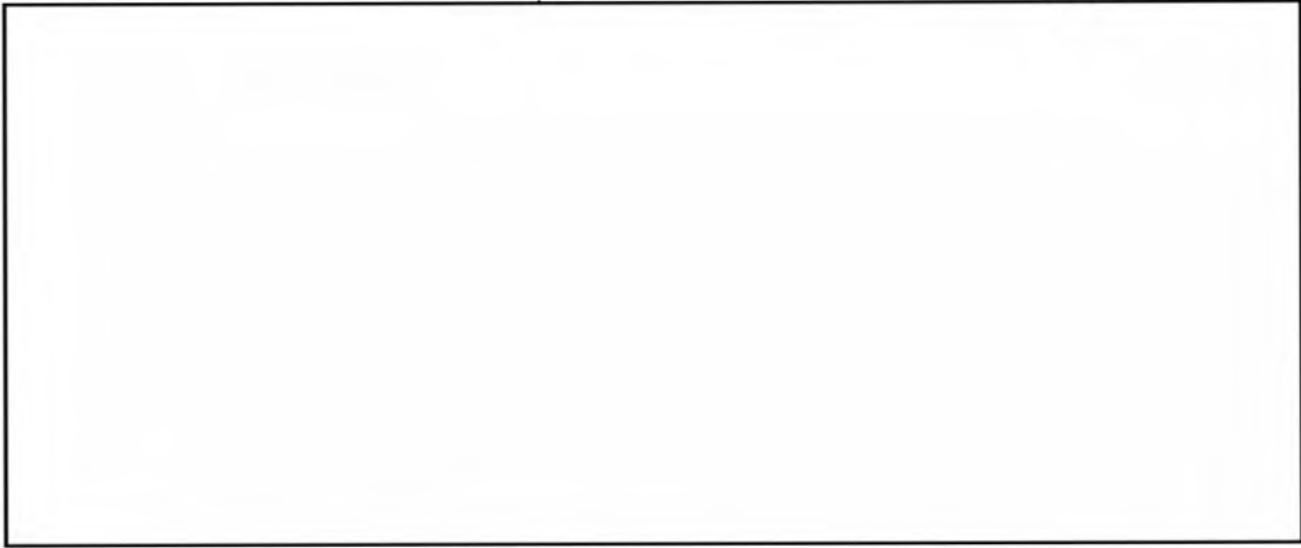

b3
b7E

GARMUR;
PFO-MURDER

Bufile #185-1426
LC #B-91125

ADIC, New York (185-1009)

I



GUILLEMO IGLESIAS, BORN 8/'31,'23 IN CUBA

b6
b7c

R

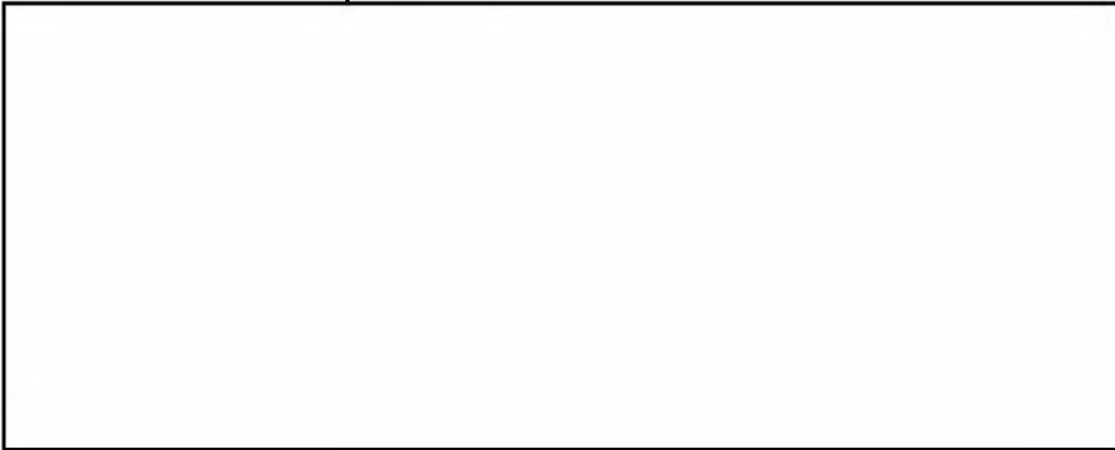

b6
b7c

INES MARIA NORIEGA RUIZ, BORN 2/18/16, USINS #A12538416

ESTHER NORIEGA RUIZ, BORN 9/18/19, USINS #A12832727

S

*
*
*
*
*



b6
b7C

LUIS ORTEGA SIERRA, BORN 6/21/16 IN CUBA



b6
b7C



FEDERAL BUREAU OF INVESTIGATION

Washington, D. C. 20537

REPORT

of the

LATENT FINGERPRINT SECTION

IDENTIFICATION DIVISION

YOUR FILE NO. 185-253 (M-10)
FBI FILE NO.
LATENT CASE NO. E-24819

April 23, 1980

TO: ADIC, New York

CAZVIZ

UNSUBS., AKA OMEGA 7;
RE: ATTEMPTED BOMBING ASSASSINATION OF
RAUL ROA-KOURI
CUBAN AMBASSADOR TO THE UNITED NATIONS
NEW YORK, NEW YORK
3-25-80
PFC - ATTEMPTED MURDER - EID

REFERENCE: Teletype 3-26-80
EXAMINATION REQUESTED BY: New York
SPECIMENS:

To date, no latent prints have previously been reported in the captioned case and in the following cases:

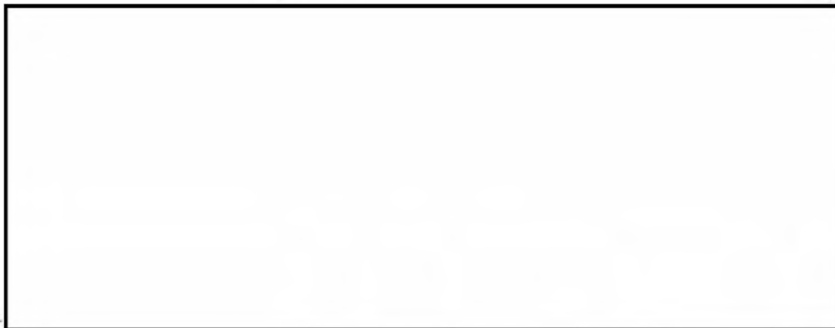

b3
b7E

185-1352-42

ORIGINAL FILED IN

(Continued on next page)

- 4 - [redacted] (1 - 183-1020)
- 3 - [redacted] (1 - 149-3930) (1 - 185-899)
- 2 - [redacted]
- 1 - Bufile [redacted] 1 - Bufile (183-3517)
- 1 - Bufile (149-12710) 1 - Bufile [redacted]
- 1 - Bufile [redacted] 1 - Bufile [redacted]
- 1 - Bufile [redacted] 1 - Bufile (185-1241)
- 1 - Bufile [redacted]

185-1241-

NOT RECORDED

29 APR 27 1980

b3
b6
b7C
b7E

68 MAY 6

MAIL #23)

Heat as yellow

FEDERAL BUREAU OF INVESTIGATION
FOI/PA
DELETED PAGE INFORMATION SHEET
FOI/PA# 1362425-000

Total Deleted Page(s) = 187

Page 3 ~ Duplicate;
Page 4 ~ Duplicate;
Page 7 ~ b6; b7C;
Page 8 ~ b6; b7C;
Page 9 ~ Referral/Direct;
Page 10 ~ Referral/Direct;
Page 11 ~ Referral/Direct;
Page 12 ~ Referral/Direct;
Page 13 ~ Referral/Direct;
Page 15 ~ b3; b6; b7C; b7D; b7E;
Page 17 ~ b3; b6; b7C; b7D; b7E;
Page 18 ~ b3; b6; b7C; b7D; b7E;
Page 19 ~ b3; b6; b7C; b7D; b7E;
Page 20 ~ b3; b6; b7C; b7D; b7E;
Page 27 ~ b3; b6; b7C; b7D; b7E;
Page 30 ~ b3; b7D; b7E;
Page 33 ~ b3; b6; b7C; b7D; b7E;
Page 34 ~ b3; b6; b7C; b7D; b7E;
Page 35 ~ b3; b6; b7C; b7D; b7E;
Page 36 ~ b3; b6; b7C; b7D; b7E;
Page 37 ~ b3; b6; b7C; b7D; b7E;
Page 40 ~ Duplicate;
Page 41 ~ Duplicate;
Page 42 ~ Duplicate;
Page 43 ~ Duplicate;
Page 44 ~ Duplicate;
Page 45 ~ Duplicate;
Page 46 ~ Duplicate;
Page 47 ~ Duplicate;
Page 48 ~ Duplicate;
Page 49 ~ Duplicate;
Page 50 ~ Duplicate;
Page 51 ~ Duplicate;
Page 52 ~ Duplicate;
Page 54 ~ Duplicate;
Page 55 ~ Duplicate;
Page 56 ~ Duplicate;
Page 57 ~ Duplicate;
Page 58 ~ Duplicate;
Page 59 ~ Duplicate;
Page 60 ~ Duplicate;
Page 62 ~ b3; b6; b7C; b7D; b7E;
Page 63 ~ b3; b6; b7C; b7D; b7E;
Page 67 ~ b6; b7C; b7D;
Page 72 ~ b6; b7C;
Page 73 ~ b3; b6; b7C; b7E;
Page 74 ~ b3; b6; b7C; b7E;
Page 75 ~ Duplicate;
Page 76 ~ Duplicate;
Page 77 ~ Duplicate;
Page 78 ~ Duplicate;
Page 79 ~ Duplicate;
Page 80 ~ Duplicate;
Page 81 ~ Duplicate;
Page 82 ~ Duplicate;
Page 83 ~ Duplicate;
Page 84 ~ Duplicate;
Page 88 ~ Duplicate;
Page 89 ~ Duplicate;
Page 90 ~ Duplicate;
Page 91 ~ Duplicate;
Page 93 ~ b3; b6; b7C; b7D; b7E;
Page 94 ~ b3; b6; b7C; b7D; b7E;
Page 95 ~ b3; b6; b7C; b7D; b7E;
Page 97 ~ Duplicate;
Page 98 ~ Duplicate;
Page 99 ~ Duplicate;

Page 100 ~ Duplicate;
Page 101 ~ Duplicate;
Page 102 ~ Duplicate;
Page 103 ~ Duplicate;
Page 104 ~ Duplicate;
Page 105 ~ Duplicate;
Page 106 ~ Duplicate;
Page 107 ~ Duplicate;
Page 108 ~ Duplicate;
Page 109 ~ Duplicate;
Page 112 ~ Duplicate;
Page 113 ~ Duplicate;
Page 114 ~ Duplicate;
Page 115 ~ Duplicate;
Page 116 ~ Duplicate;
Page 117 ~ Duplicate;
Page 118 ~ Duplicate;
Page 119 ~ Duplicate;
Page 121 ~ Duplicate;
Page 122 ~ Duplicate;
Page 123 ~ Duplicate;
Page 124 ~ Duplicate;
Page 125 ~ Duplicate;
Page 126 ~ Duplicate;
Page 127 ~ Duplicate;
Page 128 ~ Duplicate;
Page 129 ~ Duplicate;
Page 130 ~ Duplicate;
Page 131 ~ Duplicate;
Page 132 ~ Duplicate;
Page 135 ~ b3; b6; b7C; b7D; b7E;
Page 136 ~ b3; b6; b7C; b7D; b7E;
Page 137 ~ b3; b6; b7C; b7D; b7E;
Page 141 ~ Duplicate;
Page 142 ~ Duplicate;
Page 143 ~ Duplicate;
Page 144 ~ Duplicate;
Page 145 ~ Duplicate;
Page 146 ~ Duplicate;
Page 151 ~ Duplicate;
Page 152 ~ Duplicate;
Page 153 ~ Duplicate;
Page 154 ~ Duplicate;
Page 155 ~ Duplicate;
Page 156 ~ Duplicate;
Page 157 ~ Duplicate;
Page 158 ~ Duplicate;
Page 159 ~ Duplicate;
Page 160 ~ Duplicate;
Page 161 ~ Duplicate;
Page 162 ~ Duplicate;
Page 163 ~ Duplicate;
Page 164 ~ Duplicate;
Page 165 ~ Duplicate;
Page 168 ~ Duplicate;
Page 169 ~ b3; b6; b7C; b7E;
Page 170 ~ b3; b6; b7C; b7E;
Page 171 ~ b3; b6; b7C; b7E;
Page 172 ~ b3; b6; b7C; b7E;
Page 173 ~ b3; b6; b7C; b7E;
Page 174 ~ b3; b6; b7C; b7E;
Page 175 ~ b3; b6; b7C; b7E;
Page 176 ~ b3; b6; b7C; b7E;
Page 177 ~ b3; b6; b7C; b7E;
Page 178 ~ b3; b6; b7C; b7E;
Page 179 ~ b3; b6; b7C; b7E;
Page 180 ~ b3; b6; b7C; b7E;
Page 181 ~ b3; b6; b7C; b7E;
Page 182 ~ Duplicate;
Page 184 ~ Duplicate;
Page 185 ~ Duplicate;
Page 186 ~ Duplicate;
Page 187 ~ Duplicate;

Page 188 ~ Duplicate;
Page 189 ~ Duplicate;
Page 190 ~ Duplicate;
Page 191 ~ Duplicate;
Page 192 ~ Duplicate;
Page 193 ~ Duplicate;
Page 194 ~ Duplicate;
Page 195 ~ Duplicate;
Page 196 ~ Duplicate;
Page 197 ~ Duplicate;
Page 198 ~ Duplicate;
Page 199 ~ Duplicate;
Page 200 ~ Duplicate;
Page 201 ~ Duplicate;
Page 202 ~ Duplicate;
Page 203 ~ Duplicate;
Page 204 ~ Duplicate;
Page 205 ~ Duplicate;
Page 206 ~ Duplicate;
Page 207 ~ Duplicate;
Page 208 ~ Duplicate;
Page 209 ~ Duplicate;
Page 210 ~ Duplicate;
Page 211 ~ Duplicate;
Page 212 ~ Duplicate;
Page 213 ~ Duplicate;
Page 214 ~ Duplicate;
Page 215 ~ Duplicate;
Page 216 ~ Duplicate;
Page 217 ~ Duplicate;
Page 218 ~ Duplicate;
Page 219 ~ Duplicate;
Page 220 ~ Duplicate;
Page 221 ~ Duplicate;
Page 222 ~ Duplicate;
Page 223 ~ Duplicate;
Page 224 ~ Duplicate;
Page 225 ~ Duplicate;
Page 226 ~ Duplicate;
Page 227 ~ Duplicate;
Page 228 ~ Duplicate;
Page 229 ~ Duplicate;
Page 230 ~ Duplicate;
Page 231 ~ Duplicate;
Page 232 ~ Duplicate;
Page 233 ~ Duplicate;
Page 234 ~ Duplicate;

XXXXXXXXXXXXXXXXXXXXXXXXXXXXX
X Deleted Page(s) X
X No Duplication Fee X
X For this Page X
XXXXXXXXXXXXXXXXXXXXXXXXXXXXX

Field File No. _____

OO and File No. 185-899-1A1

Date Received _____

From _____

(NAME OF CONTRIBUTOR)

(ADDRESS OF CONTRIBUTOR)

(CITY AND STATE)

By _____

(NAME OF SPECIAL AGENT)

To Be Returned Yes

No

Receipt Given Yes

No

Description:

ROUGH NOTES OF _____

10/4/78

b6
b7C

b6
b7C

VZCZCHQ0173 2610350

RR HI MM NY NK

DE SJ

R 170116Z SEP 79

original to #44

b3
b6
b7C
b7E

FM SAN JUAN [redacted] (P)

TO DIRECTOR [redacted] PRIORITY

ATTN: INTELLIGENCE DIVISION, CI-2 UNIT, CRIMINAL INVESTIGATION DIVISION

MIAMI [redacted] ROUTINE

NEW YORK ROUTINE

NEWARK ROUTINE

BT

~~SECRET~~

[redacted] (OO: SAN JUAN)

b3
b7E

THIS TELETYPE IS CLASSIFIED ~~SECRET~~ IN ITS ENTIRETY.

ON SEPTEMBER 16, 1979, AN OPERATIONAL ASSET, WHO HAS PROVIDED RELIABLE INFORMATION IN THE PAST, ADVISED AS

FOLLOWS:

8/18/79

[redacted]

44 will handle telephone # lead.

[redacted]

M-10

185-899-3

SEARCHED	INDEXED
SERIALIZED	FILED
SEP 17 1979	
FBI-NEW	[redacted]

b6
b7C

[REDACTED]

~~SECRET~~

[REDACTED]

b3
b6
b7C
b7D
b7E

ADMINISTRATIVE:

REFERENCE SAN JUAN TELETYPE, SEPTEMBER 13, 1979, NO COPY
TO NEW YORK OR MIAMI.

THE OPERATIONAL ASSET IS [REDACTED]

b3
b7D

DETAILED RESULTS OF ASSETS DEBRIEFING WILL BE FORWARDED
WHEN AVAILABLE.

[REDACTED]

b3
b6
b7C
b7D

PAGE EIGHT

~~SECRET~~

b3
b6
b7C
b7D
b7E

NEW YORK IS REQUESTED TO DISCREETLY DETERMINE SUBSCRIBER TO TELEPHONE NUMBER [REDACTED] FOR THE INFORMATION OF NEW YORK AND NEWARK WHO HAVE NOT RECEIVED ALL RECENT COMMUNICATIONS INVOLVING THE PLOT AGAINST CASTRO, BACKGROUND INFORMATION CONCERNING THIS PLOT WILL BE FORWARDED IN A SUBSEQUENT COMMUNICATION.

b6
b7C

THE ASSET [REDACTED]

b3
b7D
b7E

~~C AND E, 8224, REASONS (2) AND (3), DRD SEPTEMBER 17, 1959.~~

BI

NK0004 2612020

RR HI LA MM NY SJ WF

DE NK 004

R 182020Z SEP 79

FM NEWARK [redacted] (P) (C-3)

b3
b7E

TO DIRECTOR, FBI (ROUTINE)

LOS ANGELES (ROUTINE)

MIAMI (ROUTINE)

NEW YORK (ROUTINE)

SAN JUAN (ROUTINE)

WFO (ROUTINE)

BT

~~CONFIDENTIAL~~

[redacted]; 00: BUREAU

b3
b7E

FOR INFORMATION OF RECEIVING OFFICES, SECRET SERVICE,
EAST ORANGE, NJ, FIELD OFFICE HAS ESTABLISHED ONGOING LIAISON
CONTACT WITH NEWARK DIVISION TO FACILITATE EXCHANGE OF
INFORMATION RELATIVE TO PROPOSED VISIT OF CUBAN PREMIER FIDEL
CASTRO TO UNITED NATIONS (UN) IN EARLY OCTOBER, 1979. TO
DATE, NEWARK HAS SUPPLIED EXTENSIVE BACKGROUND ON NEW JERSEY
ANTI-CASTRO, CUBAN EXILE ACTIVITIES IN GENERAL AND THE
CUBAN NATIONALIST MOVEMENT (CNM) IN PARTICULAR. ~~(S)~~ (U)

THE FOLLOWING INFORMATION, WHICH WAS OBTAINED BY NEWARK
ON SEPTEMBER 11, 1979, WAS SUPPLIED TO SECRET SERVICE

[redacted]

185-899-4

SEARCHED	INDEXED
SERIALIZED	FILED
SEP 18 1979	
FBI-NEW	

b3
b6
b7c
b7E

b3
b7E

ON SEPTEMBER 14, 1979. A HIGHLY PLACED INDIVIDUAL IN A POSITION TO SUPPLY ACCURATE INFORMATION, WHOM NEWARK IS STRONGLY CONSIDERING FOR SOURCE DEVELOPMENT, ADVISED THAT

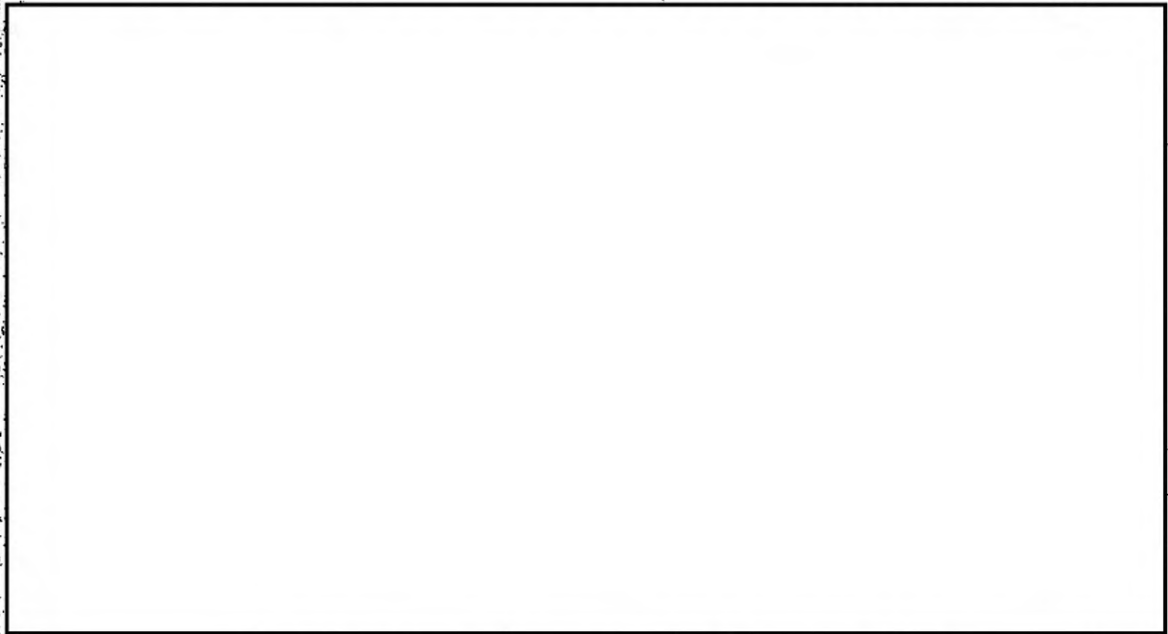

b6
b7C
b7D

[REDACTED] NO INFORMATION COULD BE PROVIDED RELATIVE TO [REDACTED] FOR THE CASTRO VISIT. ~~(C)~~ (U)

SOURCE FURTHER ADVISED THAT [REDACTED]

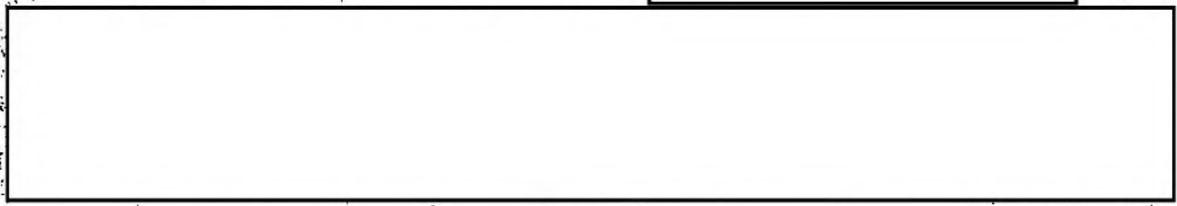

b7D

PAGE THREE, [REDACTED]

~~C O N F I D E N T I A L~~

b3
b7D
b7E

[REDACTED]
[REDACTED] ~~(S)~~ (U)

THE ABOVE INFORMATION IS SINGULAR IN NATURE AND WAS SUPPLIED TO THE BUREAU ON A CONFIDENTIAL BASIS. DISCLOSURE OUTSIDE THE GOVERNMENT WOULD ENDANGER THE SOURCE. THE INFORMATION WAS SUPPLIED TO SECRET SERVICE ON THIS BASIS. ~~(S)~~ (U)

~~C&E: 953, REASONS 2 & 3, DRD: SEPTEMBER 18, 1999~~

ADMINISTRATIVE: THE INDIVIDUAL WHO IS THE SOURCE OF THE ABOVE IS [REDACTED]

b6
b7C
b7D

[REDACTED]
BT

NK0018 2612137

RR HI CG NY MM SJ WF LA

DE NK 018

R 182137Z SEP 79

FM NEWARK [redacted] (P) (C-3)

TO DIRECTOR (ROUTINE)

CHICAGO (ROUTINE)

MIAMI [redacted] (ROUTINE)

NEW YORK (ROUTINE)

SAN JUAN (VIA FBIHQ) (ROUTINE)

WFO (ROUTINE)

LOS ANGELES [redacted] (6) (ROUTINE)

BT

~~CONFIDENTIAL~~

[redacted]

[redacted]

b3
b7E

b3
b7E

RE LOS ANGELES TELETYPE TO BUREAU, SEPTEMBER 18, 1979.

ON SEPTEMBER 17, 1979, A NEWARK NON-SYMBOL CONFIDENTIAL
SOURCE OF UNPROVEN RELIABILITY FURNISHED THE FOLLOWING
INFORMATION:

[redacted]

b6
b7C
b7D

[redacted]

182-099-5
[redacted]
01-10 SEP 18 1979
[redacted]

b3
b6
b7C
b7E

PAGE THREE, [REDACTED], ~~CONFIDENTIAL~~

ADMINISTRATIVE: NEWARK SOURCE IS [REDACTED]

[REDACTED]

BUREAU IS REQUESTED TO DISSEMINATE THE FOREGOING TO SECRET SERVICE AND OTHER APPROPRIATE AGENCIES AT DEEMED ADVISABLE.

NEW YORK, AT NEW YORK, NY: WILL APPRISE APPROPRIATE LOCAL AND FEDERAL AGENCIES AND UN SECURITY DIVISION OF THE AFOREMENTIONED.

~~C AND E 953, REASON (2 AND 3), SEPTEMBER 18, 1999.~~

BT

b3
b6
b7C
b7D
b7E

1. The first part of the document discusses the importance of maintaining accurate records of all transactions and activities. It emphasizes that this is crucial for ensuring transparency and accountability in the organization's operations.

2. The second part of the document outlines the various methods and tools used to collect and analyze data. It highlights the need for robust data management systems and the importance of regular data audits to ensure the integrity and accuracy of the information.

3. The third part of the document focuses on the role of technology in enhancing data collection and analysis. It discusses the benefits of using advanced software solutions and the importance of staying up-to-date with the latest technological advancements in the field.

4. The fourth part of the document addresses the challenges associated with data collection and analysis. It identifies common issues such as data quality, privacy concerns, and the complexity of large datasets, and provides strategies to overcome these challenges.

5. The fifth part of the document discusses the importance of data security and the measures that should be taken to protect sensitive information. It emphasizes the need for strong security protocols and the implementation of data backup and recovery procedures.

6. The sixth part of the document explores the ethical considerations surrounding data collection and analysis. It discusses the importance of obtaining informed consent from individuals and the need to ensure that data is used in a responsible and transparent manner.

7. The seventh part of the document discusses the role of data in decision-making and the importance of using data-driven insights to inform organizational strategy. It highlights the benefits of data analytics and the need for a data-driven culture within the organization.

8. The eighth part of the document discusses the future of data collection and analysis. It explores emerging trends such as artificial intelligence, machine learning, and the Internet of Things, and discusses the potential impact of these technologies on the field.

9. The ninth part of the document discusses the importance of data literacy and the need for individuals to have the skills and knowledge to effectively work with data. It emphasizes the role of education and training in developing data literacy skills.

10. The tenth part of the document discusses the importance of data governance and the need for clear policies and procedures to govern the collection, use, and sharing of data. It emphasizes the role of data governance in ensuring the integrity and security of data.

11. The eleventh part of the document discusses the importance of data privacy and the need to protect individuals' personal information. It emphasizes the need for strong privacy policies and the implementation of data protection measures.

12. The twelfth part of the document discusses the importance of data transparency and the need for organizations to be open about their data practices. It emphasizes the role of transparency in building trust and ensuring accountability.

13. The thirteenth part of the document discusses the importance of data collaboration and the need for organizations to share data and insights. It emphasizes the benefits of data collaboration in driving innovation and improving organizational performance.

14. The fourteenth part of the document discusses the importance of data innovation and the need for organizations to explore new ways of using data. It emphasizes the role of data innovation in driving growth and creating new opportunities.

15. The fifteenth part of the document discusses the importance of data ethics and the need for organizations to ensure that their data practices are ethical and responsible. It emphasizes the role of data ethics in building trust and ensuring accountability.

16. The sixteenth part of the document discusses the importance of data security and the need for organizations to protect their data from cyber threats. It emphasizes the need for strong security measures and the implementation of data backup and recovery procedures.

17. The seventeenth part of the document discusses the importance of data governance and the need for organizations to establish clear policies and procedures to govern their data. It emphasizes the role of data governance in ensuring the integrity and security of data.

18. The eighteenth part of the document discusses the importance of data literacy and the need for individuals to have the skills and knowledge to effectively work with data. It emphasizes the role of education and training in developing data literacy skills.

PAGE THREE [REDACTED]

~~CONFIDENTIAL~~

b3
b7D
b7E

ADMINISTRATIVE

THE CONFIDENTIAL SOURCE IS [REDACTED]

b7D

BUREAU IS REQUESTED TO DISSEMINATE THE FOREGOING TO SECRET SERVICE AND OTHER APPROPRIATE AGENCIES AS DEEMED ADVISABLE.

~~C AND E 9231, REASON (B), DRB SEPTEMBER 17, 1999.~~

BT

b6
b7C

GG0017 2620043
PP. HQ LA MM NK NY
DE CG

P 180043Z SEP 79

FM CHICAGO [REDACTED] (SQUAD 11)

b3
b7E

TO DIRECTOR PRIORITY

LOS ANGELES PRIORITY

MIAMI PRIORITS

NEWARK PRIORITY

NEW YORK PRIORITY

BT

~~CONFIDENTIAL~~

ATTENTION DIVISION 6, TERROVIST SECTIION; DIVISION 5,
INTELLIGENCE DIVISION

[REDACTED]

b3
b7E

ON SEPTEMBER 12, 1979, A CONFIDENTIAL SOURCE WHO HAS
PROVIDED RELIABLE INFORMATION IN THE PAST, FURNISHED THE
FOLLOWING [REDACTED]

[REDACTED]

(S)

SOURCE ADVISED THAT [REDACTED]

[REDACTED]

183-899-7

[REDACTED]

[REDACTED]

183-17

SEARCHED	INDEXED
SERIALIZED	FILED
SEP 18 1979	

[REDACTED]

b3
b6
b7C
b7D
b7E

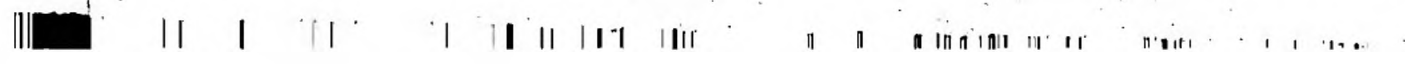



~~CONFIDENTIAL~~



b3
b6
b7C
b7D
b7E

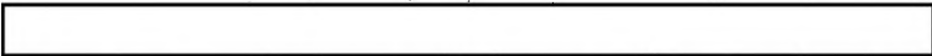

~~(S)~~ (U)

~~C AND E 1148, REASON 2, 3 AND 4, DRD SEPTEMBER 18, 1999.~~

ADMINISTRATIVE

CONFIDENTIAL SOURCE IS



b6
b7C
b7D



SOURCE IS, AT THIS TIME,

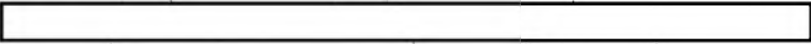

~~(S)~~ (U)

THE BUREAU IS REQUESTED,



THAT

b7D

ALL INTELLIGENCE DISSEMINATION BE PARAPHRASED PROPERLY TO INSURE SOURCE'S IDENTITY AND WELL-BEING. IT SHOULD ALSO BE

PAGE EIGHT

[REDACTED]

~~C O N F I D E N T I A L~~

NOTED THAT THE INFORMATION REGARDING

[REDACTED]

[REDACTED]

[REDACTED]

(U)

BT

b3
b7D
b7E

VZCZCHQ0281 2632257

OO HI CG LA MM NK NY WF

DE SJ 0002

O 202125Z SEP 79

FM SAN JUAN (185-70)

TO DIRECTOR IMMEDIATE

CHICAGO IMMEDIATE

LOS ANGELES IMMEDIATE

MIAMI IMMEDIATE

NEWARK IMMEDIATE

NEW YORK IMMEDIATE

WASHINGTON FIELD IMMEDIATE

BT

~~SECRET~~

SECTION 2 OF 2

PROPOSED VISIT OF CUBAN PREMIER FIDEL CASTRO TO THE UNITED STATES, OCTOBER, 1979; PFO MATTERS, (OO: NEW YORK)

SEARCHED	INDEXED
SERIALIZED	FILED
SEP 20 1979	
FBI-NEW YORK	

VZCZCHQ0321 2641844

PP HI MM NY

DE SJ 0003

P 211803Z SEP 79

FM SAN JUAN [redacted] (185-70) (P)

b3
b7E

TO DIRECTOR [redacted] PRIORITY

ATTN: INTELLIGENCE DIVISION, CI-2 UNIT, CRIMINAL
INVESTIGATIVE UNIT

MIAMI [redacted] PRIORITY

NEW YORK PRIORITY

BT

~~SECRET~~

[redacted], (OO: SAN JUAN)

b3
b7E

PROPOSED VISIT OF CUBAN PREMIER FIDEL CASTRO TO THE UNITED
STATES, OCTOBER, 1979; PFO MATTER, (OO: NEW YORK)

REFERENCE SAN JUAN TELETYPE, SEPTEMBER 20, 1979,
ENTITLED "PROPOSED VISIT OF CUBAN PREMIER FIDEL CASTRO TO
THE UNITED STATES, OCTOBER, 1979; PFO MATTER, OO: NEW YORK".

THIS TELETYPE IS CLASSIFIED "~~SECRET~~" IN ITS ENTIRETY. 185-899-13

*original
to #44*

M-10

SEARCHED	INDEXED
SERIALIZED	FILED
SEP 21 1979	
FBI-NEW	

b6
b7C

FBI

b6
b7c

TRANSMIT VIA:

- Teletype
- Facsimile
- _____

PRECEDENCE:

- Immediate
- Priority
- Routine

CLASSIFICATION:

- TOP SECRET
- SECRET
- ~~CONFIDENTIAL~~
- UNCLAS E F T O
- UNCLAS

36

Date 9/21/79

FM NEW YORK (185-) (M-10)

~~TO DIRECTOR PRIORITY~~

~~CHICAGO PRIORITY~~

~~LOS ANGELES PRIORITY~~

~~MIAMI PRIORITY~~

NEWARK PRIORITY

SAN JUAN (185-70) PRIORITY

WASHINGTON FIELD PRIORITY

BT

~~CONFIDENTIAL~~

PROPOSED VISIT OF CUBAN PREMIER FIDEL CASTRO TO THE UNITED STATES, OCTOBER 1979; PFO MATTER; OO: NEW YORK.

REFERENCE SAN JUAN IMMEDIATE TELETYPE, SEPTEMBER 21, 1979.

THE REFERENCED SAN JUAN TELETYPE ADVISED THAT SAN JUAN IS IN POSSESSION OF AN UP TO DATE PHOTO ALBUM OF CUBAN EXILE TERRORIST.

SAN JUAN IS REQUESTED TO FURNISH NYO WITH A COPY OF SAME.

NEW YORK HAS ALREADY FURNISHED UNITED STATES SECRET SERVICE.

- ① NEW YORK
- 1-SUPERVISOR # M-10
- 1-PROGRAM MANAGER, ADIC

Handwritten notes and stamps:

- HL
- HL
- 0222
- 185-899-444
- CG-0118
- LA-0143
- M-0138
- K-0555
- SEP 24 1979
- 0212

SEARCHED [] INDEXED []
SERIAL? [] FILED []

b6
b7c

[redacted] M-10 [redacted]

(3)

Approved: _____

[redacted]

Transmitted _____

(Number)

[redacted]

Per _____

[redacted]

FBI

TRANSMIT VIA:

- Teletype
 Facsimile

PRECEDENCE:

- Immediate
 Priority
 Routine

CLASSIFICATION:

- TOP SECRET
 SECRET
 CONFIDENTIAL
 UNCLAS E F T O
 UNCLAS

Date _____

PAGE TWO ~~C O N F I D E N T I A L~~

NEW YORK CITY WITH PHOTOS AND DESCRIPTIVE DATA SHEETS ON
 CUBAN NATIONALIST MOVEMENT MEMBERS IN THE NEW YORK/NEW JERSEY
 AREA.

IN REGARD TO SAN JUAN REQUEST, EXACT DATES OF CASTRO'S
 VISIT ARE UNKNOWN BY UNITED STATES SECRET SERVICE AT THIS TIME.

ON SEPTEMBER 26, 1979, NYO SPECIAL AGENTS WILL ATTEND A
 CONFERENCE REGARDING CASTRO'S VISIT. IN ATTENDANCE WILL BE
 REPRESENTATIVES OF UNITED STATES SECRET SERVICE, ARSON AND
 EXPLOSION SQUAD, INTELLIGENCE DIVISION, AND PRECINCT COMMAND
 PERSONNEL, NEW YORK CITY POLICE DEPARTMENT. HOPEFULLY, DATES
 OF THE VISIT AND PROPOSED ITINARY WILL BE AVAILABLE AT THAT
 TIME.

~~C AND E 5815, REASON 2, DRD SEPTEMBER 21, 1999.~~

BT

Approved: _____ Transmitted _____ (Number) _____ (Time) Per _____

b6
b7C

NK0009 2672245

RR HI NY

DE NK 009

R 242245Z SEP 79

FM NEWARK (185-122) (P) (C-3)

TO DIRECTOR [redacted] (ROUTINE)

b3
b7E

NEW YORK (ROUTINE)

BT

~~SECRET~~

PROPOSED VISIT OF CUBAN PREMIER FIDEL CASTRO TO THE UNITED STATES
OCTOBER, 1979.

RE MIAMI TELETYPE TO BUREAU, SEPTEMBER 20, 1979; NEWARK
TELETYPES TO BUREAU, SEPTEMBER 14 AND 17, 1979.

ON SEPTEMBER 21, 1979, [redacted] ADVISED THAT [redacted]

b6
b7C
b7D

[Large redacted block]

[Redacted box]

208-879-15
SEARCHED _____
SERIALIZED _____
M-10 SEP 24 1979

b6
b7C

[Redacted box]

Date 9/27

To: Director

Att.: _____ FILE # _____

SAC _____ Title _____

ASAC _____

Supv. _____

Agent _____

OSM _____

Rotor # _____

M _____ RE: _____

Room _____

9/27

b6
b7C

- | | | |
|---|---|--|
| <input type="checkbox"/> Acknowledge | <input type="checkbox"/> For information | <input type="checkbox"/> Return assignment card |
| <input type="checkbox"/> Assign <input type="checkbox"/> Reassign | <input type="checkbox"/> Handle | <input type="checkbox"/> Return file <input type="checkbox"/> serial |
| <input type="checkbox"/> Bring file | <input type="checkbox"/> Initial & return | |
| <input type="checkbox"/> Call me | <input type="checkbox"/> Leads need attention | <input type="checkbox"/> Return with action taken |
| <input type="checkbox"/> Correct | <input type="checkbox"/> Open case | <input type="checkbox"/> Return with explanation |
| <input type="checkbox"/> Deadline _____ | <input type="checkbox"/> Prepare lead cards | <input checked="" type="checkbox"/> Search and return |
| <input type="checkbox"/> Delinquent | <input type="checkbox"/> Prepare tickler | <input type="checkbox"/> See me |
| <input type="checkbox"/> Discontinue | <input type="checkbox"/> Recharge file. <input type="checkbox"/> serial <input type="checkbox"/> Type | |
| <input type="checkbox"/> Expedite | | |
| <input type="checkbox"/> File | <input type="checkbox"/> Send to _____ | |

SAC _____

See reverse side

Office _____

b6
b7C

MMO 016 267 2339Z

PP HQ NY SJ

DE MM

P 24 2339Z SEP 79

FM MIAMI [redacted] (P)

b3
b7E

TO DIRECTOR PRIORITY

NEW YORK ROUTINE

SAN JUAN VIA WASHINGTON PRIORITY

BT

~~SECRET~~

ATTENTION: BUREAU: INTD.

[redacted] BUREAU FILE [redacted]

b3
b6
b7C
b7E

[redacted]
[redacted] E ID; [redacted]
[redacted]

SECTIONS OF THIS TELETYPE ARE CLASSIFIED ~~SECRET~~ AS
APPROPRIATELY NOTED BELOW.

AS BUREAU IS AWARE, AN ATTEMPT WAS MADE UPON THE LIFE
OF [redacted]

b6
b7C

[redacted] THE FOLLOWING INFORMATION WAS DEVELOPED
THROUGH THE MIAMI POLICE DEPARTMENT HOMICIDE SECTION, CURRENTLY

185-899-157A NJ

b3
b6
b7C
b7E

[redacted]

[redacted]

[redacted]
[redacted]
[redacted]
SERIALIZED
M/T
SEP 24 1979
[redacted]

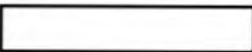

b3
b7E

INVESTIGATING THE INCIDENT.

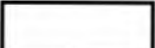
ON THE ABOVE DATE  DEPARTED HIS BUSINESS ESTABLISHMENT FOR HOME LOCATED ONLY A SHORT DISTANCE AWAY. AS HE TURNED AT AN INTERSECTION FOUR SHOTS WERE FIRED AT HIS VEHICLE FROM A PARKED STATION WAGON, INFLECTING A MINOR HEAD WOUND ON 

b6
b7C

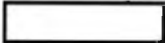
 WAS INTERVIEWED BY BUREAU AGENTS ON SEPTEMBER 24, 1979. HE WAS UNABLE TO EXPAND UPON THE ABOVE INFORMATION AND WAS UNABLE TO DESCRIBE HIS ASSAILANT OR ASSAILANTS. HE FELT STRONGLY THAT THE ATTEMPT WAS CAUSED BY AGENTS OF THE CUBAN GOVERNMENT WHO BELIEVED THAT HE IS INVOLVED IN A PLOT AGAINST FIDEL CASTRO.

b6
b7C

ADMINISTRATIVE:

REFERENCED MIAMI TELETYPE TO THE BUREAU SEPTEMBER 5, 1979, AND MIAMI TELEPHONE CALLS TO THE BUREAU AND SAN JUAN SEPTEMBER 24, 1979.

(U) ~~CS~~

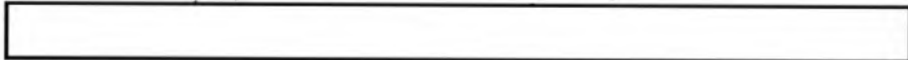

b3
b6
b7C
b7D
b7E



PAGE THREE ~~SECRET~~

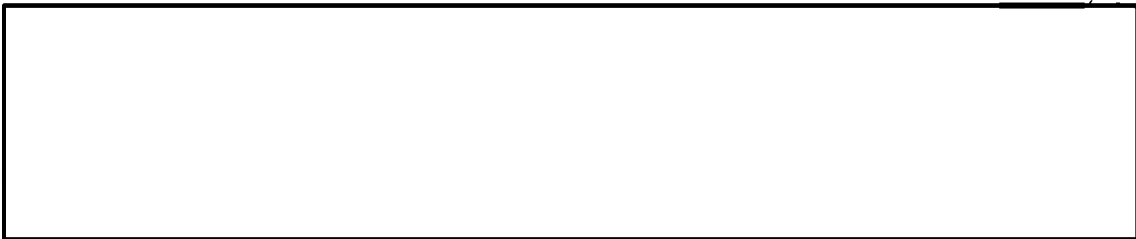

b3
b6
b7C
b7D
b7E

~~C AND E BY 6034 REASONS 2 AND 4, DRD SEPTEMBER 24,
1999.~~

BT

FBI

b6
b7c

TRANSMIT VIA:

- Teletype
- Facsimile
- _____

PRECEDENCE:

- Immediate
- Priority
- Routine

CLASSIFICATION:

- TOP SECRET
- ~~SECRET~~
- CONFIDENTIAL
- UNCLAS E F T O
- UNCLAS

Date 9/26/79

25

FM NEW YORK (185-899) (M-10)

~~TO DIRECTOR~~ PRIORITY

OK

~~CHICAGO~~ PRIORITY

~~LOS ANGELES~~ PRIORITY

~~MIAMI~~ PRIORITY

~~NEWARK~~ PRIORITY

~~SAN JUAN~~ PRIORITY

~~WASHINGTON FIELD~~ PRIORITY

BT

~~SECRET~~
Proposed

FIDEL CASTRO STATES

A VISIT OF CUBAN PREMIER TO UNITED NATIONS GENERAL ASSEMBLY,

POSSIBLE PFO. MATTER 00: NY

ON SEPTEMBER 26, SPECIAL AGENTS NYO AND NEWARK SPECIAL AGENT ATTENDED A CONFERENCE AT INTELLIGENCE DIVISION, NYCPD, RELATIVE TO THE PROPOSED VISIT OF FIDEL CASTRO. ALSO IN ATTENDANCE WERE REPRESENTATIVES OF UNITED STATES SECRET SERVICE (USSS), UNITED STATES DEPARTMENT OF STATE AND ARSON AND EXPLOSION SQUAD, NYCPD.

- 1 NEW YORK
- 1-SUPERVISOR #m-10
- 1-PROGRAM MANAGER, ADIC

SEARCHED [] INDEXED []
SERIALIZED [] FILED []
SEP 30 1979
185-899-19
Hq
Hi
0201
CG-0209
LP-0215
MA-0040
WK-0041
WF-0042

(3)

Approved: [redacted]

Transmitted [redacted]

(Number)

(Time)

Per [redacted]

b6
b7c

FBI

TRANSMIT VIA:

- Teletype
- Facsimile
- _____

PRECEDENCE:

- Immediate
- Priority
- Routine

CLASSIFICATION:

- TOP SECRET
- SECRET
- CONFIDENTIAL
- UNCLAS E F T O
- UNCLAS

Date _____

PAGE TWO ~~SECRET~~

DETECTIVE [REDACTED] INTELLIGENCE DIVISION, ADVISED THAT [REDACTED] ABDALLA HAS APPLIED FOR AND RECEIVED THE NECESSARY PERMITS TO DEMONSTRATE AT DAG ^{HAMMERKJOLD} MANNERSKJOLD-PLAZA BETWEEN 10:00 AM AND 3:00 PM, ON OCTOBER 5, 1979. THE PURPOSE OF THE DEMONSTRATION IS TO PROTEST THE VISIT OF CASTRO. THE ~~ESTIMATED~~ NUMBER OF DEMONSTRATORS IS ROUGHLY ESTIMATED AT BETWEEN 10 THOUSAND AND 20 THOUSAND PERSONS.

b6
b7C

[REDACTED] INDICATED THAT THE DEMONSTRATION WILL BE HELD EVEN IF CASTRO DOES NOT APPEAR ON THAT DATE AND A SECOND DEMONSTRATION WILL BE HELD SHOULD HE ARRIVE AT A LATER DATE.

b6
b7C

UNITED STATES DEPARTMENT OF STATE AND USSS CONTINUE ATTEMPTS TO OBTAIN THE EXACT DATE OF ARRIVAL FOR CASTRO.

ADMINISTRATIVE

REFERENCED SAN JUAN TELETYPE, DATED SEPTEMBER 21, 1979, REQUESTION ^{NG} NYO OPINION REGARDING [REDACTED]

[REDACTED]

NEW YORK CONCURS WITH SAN JUAN FOR REASONS SET FORTH IN REFERENCED SAN JUAN TELETYPE.

b3
b6
b7C
b7D
b7E

Approved: _____ Transmitted _____ (Number) _____ (Time) Per _____

FBI

TRANSMIT VIA:

- Teletype
- Facsimile
- _____

PRECEDENCE:

- Immediate
- Priority
- Routine

CLASSIFICATION:

- TOP SECRET
- SECRET
- CONFIDENTIAL
- UNCLAS E F T O
- UNCLAS

Date _____

PAGE THREE ~~SECRET~~

[Redacted]

~~C AND E 5815, REASON 2, DRD SEPTEMBER 26, 1999.~~

BT

#

b6
b7C
b7D
b7E

Approved: _____ Transmitted _____ (Number) _____ (Time) Per _____

b6
b7C

NR 262235Z

RR MI MM NY

DE NR 015

R 262235Z SEP 79

FM NEWARK [redacted] (P) (C-3)

b3
b7E

TO DIRECTOR [redacted] (ROUTINE)

MIAMI (ROUTINE)

NEW YORK (ROUTINE)

BT

UNCLAS

~~SECRET~~

[redacted]

b3
b7E

RE NEWARK TELETYPES TO BUREAU, SEPTEMBER 14, 19 AND 24, 1979,
(MIAMI NOT IN RECEIPT OF NEWARK TELETYPE DATED SEPTEMBER 24, 1979).
BUREAU TELETYPE TO NEWARK, SEPTEMBER 24, 1979, AND NEWARK TELCAL
TO BUREAU, SEPTEMBER 24, 1979.

FOR THE INFORMATION OF MIAMI, ON SEPTEMBER 21, 1979, [redacted]
ADVISED THAT [redacted]

b6
b7C
b7D

[redacted]

Index
112

185-899-21

SEARCHED	INDEXED
SERIALIZED	FILED
SEP 26 1979	
[redacted]	

b6
b7C

orig - 44

b3
b7D
b7E

[REDACTED]

ADMINISTRATIVE

AS PER REFERENCED NEWARK TELCALL TO BUREAU, SEPTEMBER 24, 1979,
IT WAS EXPLAINED THAT NEWARK IS AWARE OF INFORMATION REGARDING

[REDACTED]

b6
b7C
b7D

[REDACTED] CONTRADICTS LOGIC. NEWARK SA METICULOUSLY
REHASHED THIS INFORMATION WITH SOURCE; HOWEVER SOURCE WAS UNABLE
TO EXPAND ON THIS TOPIC. NEWARK HAS NO ADDITIONAL INFORMATION
REGARDING THIS MATTER AT THIS TIME, AND WILL RESERVE ADDITIONAL
COMMENT AS IT WOULD BE CONJECTURE.

NEWARK WILL MAINTAIN CONTACT WITH SOURCE REGARDING THIS MATTER
AND ADVISE THE BUREAU AND INTERESTED OFFICES.

~~(C AND E 553, REASONS 2 AND 3, DROPTED OCTOBER 26, 1999.)~~

BT
#

155-5

FBI

TRANSMIT VIA:

- Teletype
- Facsimile
- _____

PRECEDENCE:

- Immediate
- Priority
- Routine

CLASSIFICATION:

- TOP SECRET
- SECRET
- CONFIDENTIAL
- UNCLAS E F T O
- UNCLAS

Date 9/27/79

32

FM NEW YORK (185-899) (M-10)

TO LOS ANGELES ROUTINE

BT

~~CONFIDENTIAL~~

PROPOSED VISIT OF CUBAN PREMIER FIDEL CASTRO TO THE UNITED STATES, OCTOBER 1979; PFO MATTER.

RELATEL, SEPTEMBER 22, 1979.

FOR INFORMATION OF LOS ANGELES, NEW YORK CASE AGENT IN THIS MATTER IS SPECIAL AGENT [redacted]

SHOULD LOS ANGELES POLICE DEPARTMENT SOURCE [redacted]

[redacted] SOURCE SHOULD CONTACT SPECIAL AGENT [redacted] OR SUPERVISOR [redacted] AT TELEPHONE 212-553-2700 DAY OR NIGHT.

BT

b6
b7C

- ① NEW YORK
- 1-SUPERVISOR # M-10
- 1-PROGRAM MANAGER, ADIC

[redacted]
(3) [redacted] M-10
[redacted]

LA-1031

185-899-25

SEARCHED	INDEXED
SERIALIZED	FILED
SEP 28 1979	
NEW YORK	

b6
b7C

Approved

Transmitted

(Number)

(Time)

Per

Complaint Form
FD-71 (Rev. 8-29-74)

NOTE: Hand print names legibly; handwriting satisfactory for remainder.

Indices: Negative See below

Subject's name and aliases <i>UNSUBS(2); Threat to kill Castro; Elizabeth, NJ 9/28/79</i>	Character of case <i>PFO</i>
	Complainant <i>Anonymous</i>
	Complaint received <input type="checkbox"/> Personal <input checked="" type="checkbox"/> Telephonic Date <i>9/29/79</i> Time <i>12⁰⁵ P</i>
Address of subject	Complainant's address and telephone number

Subject's Description	Race	Sex <input type="checkbox"/> Male <input type="checkbox"/> Female	Height	Hair	Build	Birth date and Birthplace
	Age		Weight	Eyes	Complexion	Social Security Number
	Scars, marks or other data					

Facts of complaint

Complainant, refused to identify himself, stated he was in [redacted] Elizabeth, NJ, yesterday (9/28) and overheard 2 Hispanic males saying Castro should be killed. Complainant advised one individual is (FNU) [redacted] and refused to identify the other male. Complainant stated UNSUBS live [redacted]

185-899-26

[redacted]

[redacted]

Action Recommended

[redacted]

M7D

b6
b7C
b7D

b6
b7C

ADMINISTRATIVE: FIRST SOURCE IS [REDACTED] SECOND SOURCE
IS [REDACTED]

b3
b7D

VZCZCHQ0635 2750634

R HI MM NK NY SF WF

DE SJ

R 010214Z OCT 79

FM SAN JUAN [redacted] (185-70)

TO DIRECTOR [redacted] ROUTINE

b3
b7E

ATTENTION: INTELLIGENCE DIVISION, CI-2 UNIT, CRIMINAL
INVESTIGATIVE DIVISION

MIAMI [redacted] ROUTINE

NEWARK ROUTINE

NEW YORK ROUTINE

SAN FRANCISCO ROUTINE

WASHINGTON FIELD ROUTINE

BT

~~SECRET~~

[redacted]

b3
b7E

PROPOSED VISIT OF CUBAN PREMIER FIDEL CASTRO TO THE UNITED
STATES, OCTOBER 5, 1979; PFO MATTER (OO: NEW YORK)

~~2~~

185-8000 32

[redacted]

[redacted]

b3
b6
b7C
b7E

SEARCHED [redacted] INDEXED [redacted]
SERIAL [redacted] FILED [redacted]

OCT 2 1979

[redacted]

cc-44

[redacted]

PAGE TWO [REDACTED] (185-70) ~~SECRET~~

b3
b6
b7C
b7E

REFERENCE SAN JUAN TELETYPE, OCTOBER 1, 1979, ENTITLED,
[REDACTED], AND MIAMI TELETYPE, SEPTEMBER 28,
1979, ENTITLED, [REDACTED]
[REDACTED] EID; PROPOSED VISIT OF CUBAN PREMIER FIDEL CASTRO
TO THE UNITED STATES, OCTOBER, 1979; PFO MATTER."

THIS COMMUNICATION IS CLASSIFIED "~~SECRET~~" IN ITS
ENTIRETY.

FOR THE INFORMATION OF NEWARK AND WASHINGTON FIELD WHO
DID NOT RECEIVE REFERENCED MIAMI TELETYPE, MIAMI ADVISED
THAT [REDACTED]

b3
b7D

[REDACTED]

ON SEPTEMBER 30, 1979, [REDACTED] ADVISED THAT [REDACTED]

b3
b6
b7C
b7D

[REDACTED]

PAGE SIX

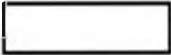

(184-70)

~~SECRET~~

b3
b6
b7C
b7D
b7E

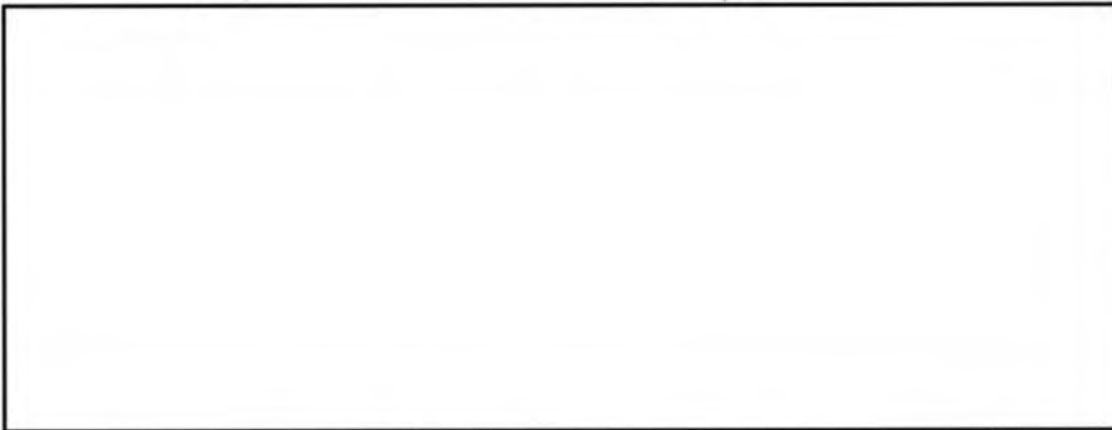

BASED ON A NEWSPAPER STORY IN THE OCTOBER 1, 1979 EDITION OF THE MIAMI HERALD REPORTING THE RESULTS OF A "60 MINUTES" TELEVISION SHOW INTERVIEW OF CASTRO, CASTRO DOES NOT KNOW WHEN HE WILL VISIT NEW YORK. IN ADDITION, IT IS DOUBTFUL CASTRO WOULD COME TO THE UNITED STATES AT THE SAME TIME POPE JOHN PAUL II IS HERE. THEREFORE, SAN JUAN RECOMMENDS

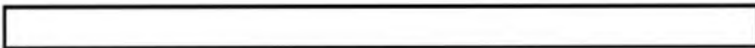

b3
b6
b7C
b7D
b7E

PAGE SEVEN



(184-70)

~~SECRET~~

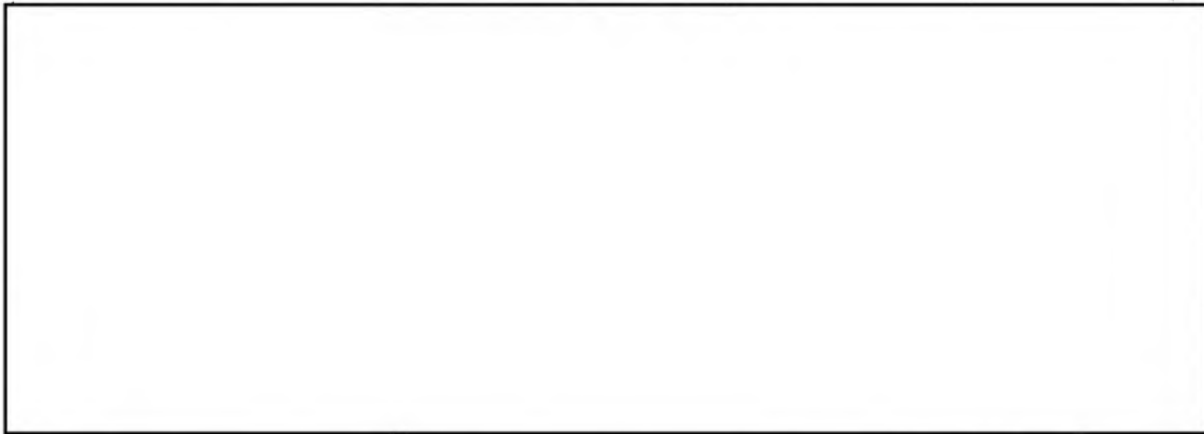

b3
b6
b7C
b7D
b7E

IF AND WHEN CASTRO GOES TO NEW YORK, SAN JUAN BELIEVES

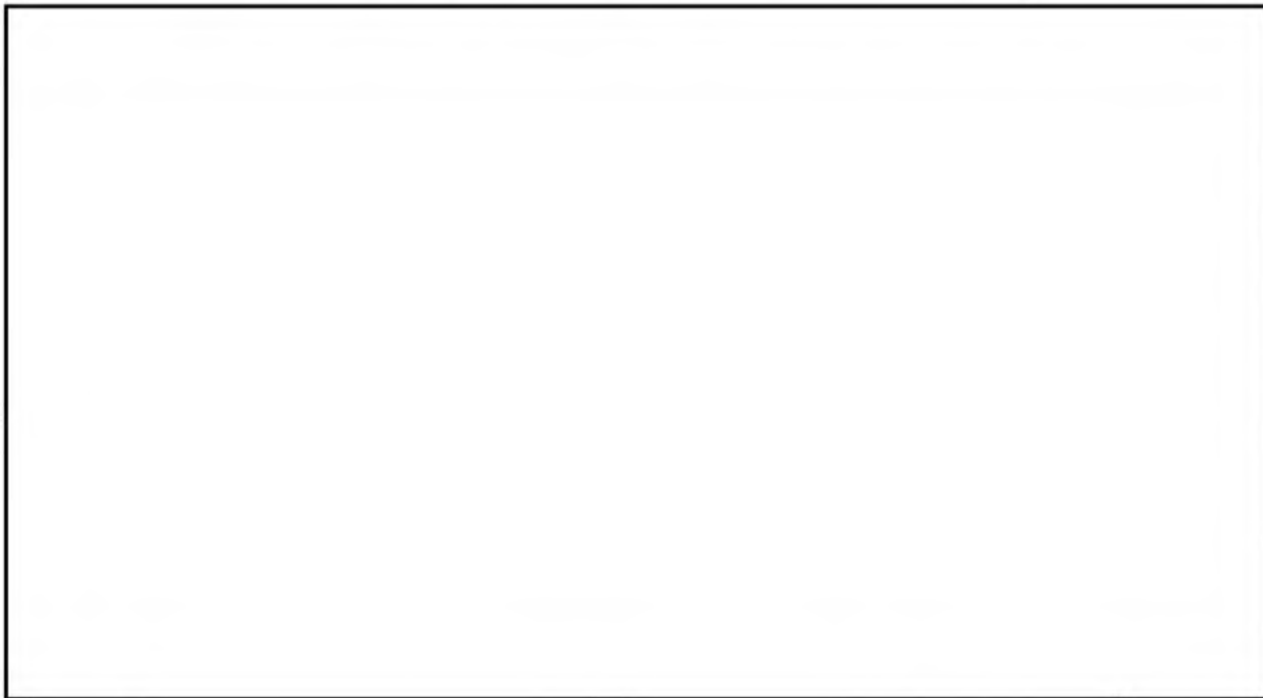

b3
b6
b7C
b7D
b7E

PAGE EIGHT [] (184-70) ~~SECRET~~

b3
b7D
b7E

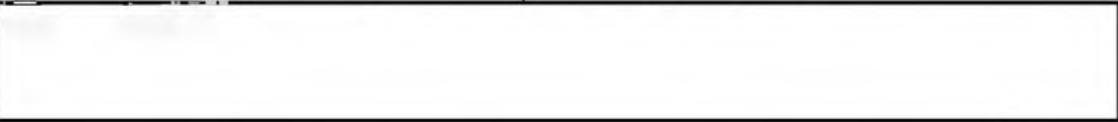

SAN JUAN WILL KEEP INTERESTED OFFICES EXPEDITIOUSLY ADVISED OF DEVELOPMENTS IN THIS MATTER.

~~C AND E, 5024, REASONS (2) AND (3), DRD OCTOBER 1, 1999.~~

BT

b6
b7c

SFO007 277013Z

PP HI MM NY SJ

DE SF 007 P 030010Z OCT 79

FM SAN FRANCISCO [redacted] (SQ. 14)

b3
b7E

TO DIRECTOR [redacted] (PRIORITY)

MIAMI [redacted] (PRIORITY)

NEW YORK (PRIORITY)

SAN JUAN [redacted] (PRIORITY) (SJ VIA FBIHQ)

BT

~~CONFIDENTIAL~~

ATTENTION INTELLIGENCE DIVISION

[redacted] 00: MIAMI

b3
b7E

REFERENCE MIAMI TELETYPE TO THE BUREAU, DATED P270006Z
SEPTEMBER 79.

THE FOLLOWING IS BACKGROUND INFORMATION ON [redacted]

[redacted] BORN [redacted] (S) (U)

b3
b6
b7C
b7E

A REVIEW OF SAN FRANCISCO RECORDS REVEALED FILE [redacted]

(BUREAU FILE [redacted] FROM WHICH

THE FOLLOWING IS EXTRACTED: (S) (U)

ON APRIL 30, 1977, [redacted], ALONG WITH FOUR OTHER INDIVIDUALS,

b6
b7C

Text
2
M-10

185-899-36

SEARCHED	[redacted]
SERIALIZED	[redacted]
OCT 3 1979	
FBI-NEW YORK	

[redacted]

b6
b7C

[redacted]

[REDACTED]

[REDACTED] WAS SPOTTED CONDUCTING MILITARY MANEUVERS AT LOS PADRES NATIONAL FOREST. THE FOREST IS IN CLOSE PROXIMITY TO FORT ORD, CALIFORNIA, MONTEREY, CALIFORNIA. REPORTEDLY, THE FIVE INDIVIDUALS WERE IN POSSESSION OF M-14'S, M-16'S AND AK-47'S. [REDACTED] LATER CONFIRMED THESE REPORTS, HOWEVER, DENIED POSSESSION OF ANY AUTOMATIC WEAPONS, AND STATED THE CLOSEST THING THEY HAD TO A MACHINEGUN WAS AN AR-15 RIFLE. NO AMMUNITION WAS IN THE CHAMBER. ~~(S)~~ (U)

THIS INFORMATION WAS RECEIVED FROM THE BUREAU OF ALCOHOL, TOBACCO AND FIREARMS (ATF), SAN FRANCISCO, CALIFORNIA, ON MAY 23, 1977. ~~(S)~~ (U)

SUBSEQUENT TO ABOVE, [REDACTED] WAS INTERVIEWED BY ATF, AND IT WAS LEARNED THAT [REDACTED] THE BAY OF PIGS VETERANS. [REDACTED] JOINED ALPHA 66 (62 CHAPTERS NATIONWIDE). THIS ORGANIZATION IS DIRECTED BY ANDRE NAZARIO. ~~(S)~~ (U)

RECORDS FURTHER INDICATE THAT ON JUNE 4, 1977, THE SANTA CLARA POLICE DEPARTMENT RESPONDED TO REPORTS OF GUNSHOT

[REDACTED]

[REDACTED]

[REDACTED]

~~(S)~~ (U)

SOURCE SPECULATES THAT

[REDACTED]

[REDACTED]

~~(S)~~ (U)

SAN FRANCISCO WILL FURTHER ATTEMPT TO LOCATE

[REDACTED]

~~(S)~~ (U)

~~CONFIDENTIAL. C AND E 7087, REASON (2).~~

~~DRD OCTOBER 3, 1999.~~

BT

b3
b6
b7C
b7D
b7E

b6
b7C

MMO 004 277 1646Z

PP HQ NY SF SJ

DE NY
P04 1646Z OCT 79

FROM MIAMI [redacted] P

TO DIRECTOR PRIORITY
NEW YORK PRIORITY

b3
b7E

SAN FRANCISCO PRIORITY

SAN JUAN (VIA WASHINGTON) ROUTINE

BT

~~CONFIDENTIAL~~
ATTENTION: INTD.

[redacted] full search

[redacted] BUFILE [redacted]
[redacted] EID (A), [redacted]

b3
b6
b7C
b7E

PROPOSED VISIT OF CUBAN PREMIER FIDEL CASTRO TO THE UNITED STATES, OCTOBER, 1979, PFO MATTER, OO: NEW YORK.

RE SAN FRANCISCO TELETYPE TO THE BUREAU, OCTOBER 3, 1979,

ENTITLED [redacted] AND SAN FRANCISCO TELEPHONE CALL TO MIAMI, OCTOBER 3, 1979.

b3
b6
b7C
b7E

DURING LATE EVENING OF OCTOBER 2, 1979, AN INDIVIDUAL WHO WAS IDENTIFIED AS [redacted] WAS OBSERVED AT MIAMI

[redacted]

b6
b7C

185-899-39A
SEARCHED [redacted]
SERIALIZED [redacted]
OCT 4 1979
FBI-NEW YORK
[redacted]

M-10

PAGE TWO

~~CONFIDENTIAL~~

INTERNATIONAL AIRPORT BOARDING NATIONAL AIRLINES FLIGHT 602 FOR
NEWARK, NEW JERSEY. [REDACTED] DESCRIBED AS WHITE MALE, [REDACTED]

b3
b6
b7C
b7E

[REDACTED] SURVEILLANCE PHOTOS

OF QUESTIONABLE VALUE OBTAINED.

MIAMI, ON OCTOBER 3, 1979, RECEIVED TELECOPIER PHOTOGRAPH
OF THE [REDACTED] DESCRIBED IN REFERENCED TELETYPE AND IT
WAS ASCERTAINED THAT HE IS IDENTICAL WITH INDIVIDUAL OBSERVED
AT MIAMI INTERNATIONAL AIRPORT.

REFERENCED TELEPHONE CALL FROM SAN FRANCISCO ALSO INDICATED
THAT INFORMATION DEVELOPED THAT [REDACTED] HAD DEPARTED SANTA CLARA,
CALIFORNIA, FOR MIAMI, FLORIDA, ON SEPTEMBER 28, 1979.

b6
b7C

SAN FRANCISCO REQUESTED TO IMMEDIATELY FURNISH NEW YORK
COPIES OF PHOTO OF [REDACTED] TOGETHER WITH ANY

ADDITIONAL PERTINENT INFORMATION AVAILABLE.

~~C & E BY 8334, REASONS 2 & 3, DSD OCTOBER 4, 1999.~~

BT

2771650 NY 1

FEDERAL BUREAU OF INVESTIGATION
FOI/PA
DELETED PAGE INFORMATION SHEET
FOI/PA# 1362425-000

Total Deleted Page(s) = 265

- Page 2 ~ Duplicate;
- Page 3 ~ Duplicate;
- Page 4 ~ Duplicate;
- Page 5 ~ Duplicate;
- Page 6 ~ Duplicate;
- Page 7 ~ Duplicate;
- Page 8 ~ Duplicate;
- Page 9 ~ Duplicate;
- Page 10 ~ Duplicate;
- Page 11 ~ Duplicate;
- Page 12 ~ Duplicate;
- Page 13 ~ Duplicate;
- Page 14 ~ Duplicate;
- Page 15 ~ Duplicate;
- Page 16 ~ Duplicate;
- Page 17 ~ Duplicate;
- Page 18 ~ Duplicate;
- Page 19 ~ Duplicate;
- Page 20 ~ Duplicate;
- Page 21 ~ Duplicate;
- Page 22 ~ Duplicate;
- Page 23 ~ Duplicate;
- Page 24 ~ Duplicate;
- Page 25 ~ Duplicate;
- Page 26 ~ Duplicate;
- Page 27 ~ Duplicate;
- Page 28 ~ Duplicate;
- Page 29 ~ Duplicate;
- Page 30 ~ Duplicate;
- Page 31 ~ Duplicate;
- Page 32 ~ Duplicate;
- Page 34 ~ Duplicate;
- Page 35 ~ Duplicate;
- Page 36 ~ Duplicate;
- Page 37 ~ Duplicate;
- Page 38 ~ Duplicate;
- Page 39 ~ Duplicate;
- Page 40 ~ Duplicate;
- Page 41 ~ Duplicate;
- Page 42 ~ Duplicate;
- Page 43 ~ Duplicate;
- Page 44 ~ Duplicate;
- Page 45 ~ Duplicate;
- Page 46 ~ Duplicate;
- Page 47 ~ Duplicate;
- Page 48 ~ Duplicate;
- Page 49 ~ Duplicate;
- Page 50 ~ Duplicate;
- Page 51 ~ Duplicate;
- Page 52 ~ Duplicate;
- Page 53 ~ Duplicate;
- Page 54 ~ Duplicate;
- Page 55 ~ Duplicate;
- Page 56 ~ Duplicate;
- Page 57 ~ Duplicate;
- Page 58 ~ Duplicate;
- Page 59 ~ Duplicate;
- Page 60 ~ Duplicate;
- Page 61 ~ Duplicate;
- Page 62 ~ Duplicate;
- Page 63 ~ Duplicate;
- Page 64 ~ Duplicate;
- Page 65 ~ Duplicate;
- Page 66 ~ Duplicate;
- Page 67 ~ Duplicate;
- Page 68 ~ Duplicate;
- Page 69 ~ Duplicate;

Page 70 ~ Duplicate;
Page 71 ~ Duplicate;
Page 72 ~ Duplicate;
Page 73 ~ Duplicate;
Page 74 ~ Duplicate;
Page 75 ~ Duplicate;
Page 76 ~ Duplicate;
Page 77 ~ Duplicate;
Page 79 ~ Duplicate;
Page 80 ~ Duplicate;
Page 81 ~ Duplicate;
Page 82 ~ Duplicate;
Page 83 ~ Duplicate;
Page 84 ~ Duplicate;
Page 85 ~ Duplicate;
Page 86 ~ Duplicate;
Page 87 ~ Duplicate;
Page 88 ~ Duplicate;
Page 89 ~ Duplicate;
Page 90 ~ Duplicate;
Page 91 ~ Duplicate;
Page 92 ~ Duplicate;
Page 93 ~ Duplicate;
Page 94 ~ Duplicate;
Page 95 ~ Duplicate;
Page 96 ~ Duplicate;
Page 97 ~ Duplicate;
Page 98 ~ Duplicate;
Page 99 ~ Duplicate;
Page 100 ~ Duplicate;
Page 101 ~ Duplicate;
Page 102 ~ Duplicate;
Page 103 ~ Duplicate;
Page 104 ~ Duplicate;
Page 105 ~ Duplicate;
Page 106 ~ Duplicate;
Page 107 ~ Duplicate;
Page 108 ~ Duplicate;
Page 109 ~ Duplicate;
Page 110 ~ Duplicate;
Page 111 ~ Duplicate;
Page 112 ~ Duplicate;
Page 113 ~ Duplicate;
Page 114 ~ Duplicate;
Page 115 ~ Duplicate;
Page 116 ~ Duplicate;
Page 117 ~ Duplicate;
Page 118 ~ Duplicate;
Page 119 ~ Duplicate;
Page 120 ~ Duplicate;
Page 121 ~ Duplicate;
Page 122 ~ Duplicate;
Page 123 ~ Duplicate;
Page 124 ~ Duplicate;
Page 125 ~ Duplicate;
Page 126 ~ Duplicate;
Page 127 ~ Duplicate;
Page 128 ~ Duplicate;
Page 129 ~ Duplicate;
Page 130 ~ Duplicate;
Page 131 ~ Duplicate;
Page 132 ~ Duplicate;
Page 133 ~ Duplicate;
Page 134 ~ Duplicate;
Page 135 ~ Duplicate;
Page 136 ~ Duplicate;
Page 137 ~ Duplicate;
Page 138 ~ Duplicate;
Page 139 ~ Duplicate;
Page 140 ~ Duplicate;
Page 141 ~ Duplicate;
Page 142 ~ Duplicate;
Page 143 ~ Duplicate;

Page 144 ~ Duplicate;
Page 145 ~ Duplicate;
Page 146 ~ Duplicate;
Page 147 ~ Duplicate;
Page 148 ~ Duplicate;
Page 149 ~ Duplicate;
Page 150 ~ Duplicate;
Page 151 ~ Duplicate;
Page 152 ~ Duplicate;
Page 153 ~ Duplicate;
Page 154 ~ Duplicate;
Page 155 ~ Duplicate;
Page 156 ~ Duplicate;
Page 157 ~ Duplicate;
Page 158 ~ Duplicate;
Page 159 ~ Duplicate;
Page 160 ~ Duplicate;
Page 161 ~ Duplicate;
Page 162 ~ Duplicate;
Page 163 ~ Duplicate;
Page 164 ~ Duplicate;
Page 165 ~ Duplicate;
Page 166 ~ Duplicate;
Page 167 ~ Duplicate;
Page 168 ~ Duplicate;
Page 169 ~ Duplicate;
Page 170 ~ Duplicate;
Page 171 ~ Duplicate;
Page 172 ~ Duplicate;
Page 173 ~ Duplicate;
Page 174 ~ Duplicate;
Page 175 ~ Duplicate;
Page 176 ~ Duplicate;
Page 177 ~ Duplicate;
Page 178 ~ Duplicate;
Page 179 ~ Duplicate;
Page 180 ~ Duplicate;
Page 181 ~ Duplicate;
Page 182 ~ Duplicate;
Page 183 ~ Duplicate;
Page 184 ~ Duplicate;
Page 185 ~ Duplicate;
Page 189 ~ Duplicate;
Page 190 ~ Duplicate;
Page 191 ~ Duplicate;
Page 192 ~ Duplicate;
Page 193 ~ Duplicate;
Page 194 ~ Duplicate;
Page 195 ~ Duplicate;
Page 196 ~ Duplicate;
Page 197 ~ Duplicate;
Page 198 ~ Duplicate;
Page 199 ~ Duplicate;
Page 200 ~ Duplicate;
Page 201 ~ Duplicate;
Page 202 ~ Duplicate;
Page 203 ~ Duplicate;
Page 204 ~ Duplicate;
Page 205 ~ Duplicate;
Page 206 ~ Duplicate;
Page 207 ~ Duplicate;
Page 208 ~ Duplicate;
Page 209 ~ Duplicate;
Page 210 ~ Duplicate;
Page 211 ~ Duplicate;
Page 212 ~ Duplicate;
Page 213 ~ Duplicate;
Page 214 ~ Duplicate;
Page 215 ~ Duplicate;
Page 216 ~ Duplicate;
Page 217 ~ Duplicate;
Page 218 ~ Duplicate;
Page 219 ~ Duplicate;

Page 220 ~ Duplicate;
Page 221 ~ Duplicate;
Page 222 ~ Duplicate;
Page 223 ~ Duplicate;
Page 224 ~ Duplicate;
Page 225 ~ Duplicate;
Page 226 ~ Duplicate;
Page 227 ~ Duplicate;
Page 228 ~ Duplicate;
Page 229 ~ Duplicate;
Page 230 ~ Duplicate;
Page 231 ~ Duplicate;
Page 232 ~ Duplicate;
Page 233 ~ Duplicate;
Page 234 ~ Duplicate;
Page 235 ~ Duplicate;
Page 236 ~ Duplicate;
Page 237 ~ Duplicate;
Page 238 ~ Duplicate;
Page 239 ~ Duplicate;
Page 240 ~ Duplicate;
Page 241 ~ Duplicate;
Page 242 ~ Duplicate;
Page 243 ~ Duplicate;
Page 244 ~ Duplicate;
Page 245 ~ Duplicate;
Page 246 ~ Duplicate;
Page 247 ~ Duplicate;
Page 248 ~ Duplicate;
Page 249 ~ Duplicate;
Page 250 ~ Duplicate;
Page 251 ~ Duplicate;
Page 252 ~ Duplicate;
Page 253 ~ Duplicate;
Page 254 ~ Duplicate;
Page 255 ~ Duplicate;
Page 256 ~ Duplicate;
Page 257 ~ Duplicate;
Page 258 ~ Duplicate;
Page 259 ~ Duplicate;
Page 260 ~ Duplicate;
Page 261 ~ Duplicate;
Page 262 ~ Duplicate;
Page 263 ~ Duplicate;
Page 264 ~ Duplicate;
Page 265 ~ Duplicate;
Page 266 ~ Duplicate;
Page 267 ~ Duplicate;
Page 268 ~ Duplicate;
Page 269 ~ Duplicate;
Page 270 ~ Duplicate;
Page 271 ~ Duplicate;

XXXXXXXXXXXXXXXXXXXXXXXXXXXXX
X Deleted Page(s) X
X No Duplication Fee X
X For this Page X
XXXXXXXXXXXXXXXXXXXXXXXXXXXXX



UNITED STATES DEPARTMENT OF JUSTICE
FEDERAL BUREAU OF INVESTIGATION

In Reply
File No. 185-734

Washington Field Office
1900 Half Street, S. W.
Washington, D. C. 20535
September 21, 1979

b6
b7C

Passport Office
U. S. Department of State
Washington, D. C. 20524

To Whom It May Concern:

In connection with an official investigation being conducted by this Bureau, it is requested the passport file of the following person be made available to a representative of this Office for appropriate review:

b6
b7C

Name: [Redacted]

Date and Place of Birth: [Redacted]

SPOUSE: [Redacted]
Passport Number: [Redacted]
EMPLOYED: [Redacted]

Statute (Civil/Criminal): _____

Your cooperation in this matter is sincerely appreciated.

Very truly yours,
CAm/GM
Charles R. McKinnon
Special Agent in Charge

RECORD OF RELEASE OF INFORMATION

185-734-8

As a duly accredited representative of the requesting agency named above, I hereby certify, by my signature, that the review of this title is on behalf of the agency I represent and is for official United States Government use only. All information extracted or obtained will be handled in accordance with its classification. I further understand that no papers are to be taken from the file without the authorization and consent of the representative of the Passport Office who released this file for review.

No Record Located _____
2 Passport _____
WFO _____
Copies Provided _____
By Whom Released _____
Signature of Reviewer _____ Date _____

b6
b7C



185-73419

SEARCHED	INDEXED
SERIALIZED	FILED

OCT 4 1979

FBI-WASH. FIELD

Vice President Reportedly to Fill In

Castro Decides Against Addressing U.N.

By Karen DeYoung

Washington Post Foreign Service

Cuban President Fidel Castro has decided against an anticipated visit to New York to address the current U.N. General Assembly as chairman of the 94-nation nonaligned movement.

Cuba has made no official announcement on the visit, which Castro, as late as last Saturday said was still under consideration. But sources said the United Nations has been informed that a scheduled Oct. 12 speech by Cuba will be given by Vice President Carlos Rafael Rodriguez rather than Castro.

The visit would have been Castro's first to the United States since 1960, when he addressed a U.N. General Assembly remembered primarily for Soviet Premier Nikita Khrushchev banging his shoe on the table, and bearing-hugging Castro in now-famous photographs.

Speculation on why Castro has decided not to travel to New York centered on three themes. Some informed observers cited severe security problems, including planned demonstrations by stridently anti-Castro exile groups.

A U.N. spokesman, however, denied that Castro would present a security risk. "We've just been through security for the pope," he said. "I think we can handle Castro. We also have a lot of people here who are not particularly popular in New York, and it's never deterred them or us."

Others speculated that both Castro and the Soviet Union, following weeks of negotiations, charges and countercharges, and President Carter's Monday night speech on the alleged presence of a Soviet combat brigade in Cuba, would now like the issue to die down.

Anything Castro might say in New York, observers said, could bring the confrontation back into the limelight.

Others noted that a backlash had already occurred at the United Nations among some nonaligned nations over Cuba's handling of the chairmanship of the organization's summit meeting in Havana last month.

A number of countries charged that Castro had misused some of the chairman's authority in an attempt to push the movement closer to the Soviet Union. One member nation, Burma, already has indicated its intention to

resign from the organization for that reason. As with the Soviet troops issue, any Castro speech in New York could reopen the confrontation and serve to offset any gains Cuba feels may be made by a Castro appearance at the General Assembly.

Cuban diplomats both at the United Nations and in Washington had no comment on either the decision not to attend, or the reasons for it.

Ramon Sanchez-Parodi, chief of the Cuban interests Section here, said he was "not able to confirm or deny" that Castro had decided not to come.

There were indications that neither Sanchez-Parodi nor the Cuban mission at the United Nations had transmitted Castro's decision, but rather that it had been conveyed to U.N. Secretary-General Kurt Waldheim's office by Cuban Foreign Minister Isidoro Malmierca. Malmierca is in New York for a scheduled nonaligned foreign ministers' meeting today.

Malmierca attended Secretary of State Cyrus Vance's reception tonight for Latin American foreign ministers. A U. S. spokesman said the Cuban was in a "cordial mood."

Meanwhile, the Cuban Communist

Party newspaper Granma yesterday accused Carter of trying to blackmail Castro on the troops issue, and said that Carter's Monday night speech on the subject took a "devious path of half-truths."

The Granma article was the first official Cuban reaction to the speech, in which Carter said the alleged presence of a Soviet combat brigade in Cuba presents no security threat to the United States, but outlined several military measures to counterbalance it.

Granma said Carter had contradicted himself by stating that the situation did not justify a return to the cold war, yet announcing cold war measures. By alleging that the Soviet presence contributed to tension in the Caribbean and Central America, the article said, Washington was taking measures that were designed to intimidate countries with "progressive" governments.

Echoing Castro's description of the troops issue in his news conference last Friday, Granma said that Carter had tried to "bring down a hurried flannel curtain on the comedy."

Castro security tight after death threats

By GILBERT A. LEWIS
Sun Staff Correspondent

New York—Security measures were stepped up here last night in the wake of death threats to Cuban President Fidel Castro, due to address the United Nations General Assembly.

Mr. Castro is expected to take the U.N. podium this week as current leader of the nonaligned movement of more than 90 nations.

It will be the Cuban leader's first trip to the United States in 19 years, and it coincides with a period of particular tension over the presence of a Soviet combat force on the Caribbean island.

Already New York police report numerous death threats that they are taking seriously, particularly since thousands of Cuban exiles are vehemently opposed to Mr. Castro's journey here.

For security reasons, the Cubans have refused to give any exact details of when Mr. Castro will arrive with his expected entourage of 200 officials, many of them security agents, or when he will speak to the U.N.

U.S. officials expect that he will use the occasion to launch another broadside against U.S. policy, rivaling the tirade he

issued at the conference of nonaligned nations in Havana last month.

Already some Third World nations in the U.N. have taken steps to curb what they see as the excessive anti-U.S. content of Mr. Castro's proposed remarks, but it is still not clear how effective their moves will be.

The Third World nations agreed to delete some of the more severe anti-U.S. phrases in a Cuban draft report of the Havana conference, but how binding this will prove to be on Mr. Castro remains to be seen.

"Knowing Fidel's bold and combative personality, it is hard to imagine that he will feel the time is right for moderation," said one U.S. official.

U.S.-Cuban relations have recently been stretched to crisis point by the presence of the Soviet combat force on the off-shore island, which Mr. Castro has claimed is nothing more than a training unit. The Cuban president is expected to take particular offense at President Carter's decision to respond to the threat by increasing U.S. military strength in the Caribbean.

Traditionally the leader of the non-aligned movement—Mr. Castro will be

president for the next three years—has addressed the United Nations basically on the concerns of the Third World. But the Cuban president also has the right to speak as a national leader, and one U.S. official said: "Apart from the attempt to couch the nonaligned movement's presentation in strong terms, which the Cubans have always done, I would imagine that somewhere during the visit he will address the issue of Caribbean security and Cuban-U.S. relations."

The last time the Cuban leader was here was in 1960, when his 4½-hour speech to the United Nations set a still-standing record for verbosity. More recently Mr. Castro has tampered the length, if not the vitriolic content, of his remarks, and there is little doubt that the United States will be subjected to the full force of his rhetoric when he addresses the United Nations.

Protesters burn U.S. flags

San Salvador, El Salvador (AP)—Demonstrators angered over cuts in the country's education budget marched on the United States Embassy and burned three American flags, police here said yesterday.

185-734-38

SEARCHED _____ INDEXED _____
SERIALIZED _____ FILED _____

OCT 15 1979

FBI - WASH. FIELD OFFICE

b6
b7c

Cops fear kamikaze corps has its sights trained on Castro

By DAVID SEIFMAN
POLICE FEAR anti Castro fanatics may try a "kamikaze" attack on the Cuban leader when he comes to New York this week.

"We've got to treat this guy as though someone with a hand grenade in his pocket might try to walk up to him," said one high police official, who asked not to be identified.

Anti-Castro sentiment is near the boiling point, he said. "The people trying to kill this guy are serious. They won't mind taking a few cops along with them."

Police will "freeze" every area where the Cuban leader stays or travels. No one goes in but police and Secret Service.

Police believe Castro will arrive tomorrow for a three or four-day visit during which he'll address the UN.

Cautious Cuban security men have yet to release Castro's itinerary here.

Besides fanatics ready to die to kill Castro, police are concerned about a team of hitmen said to be heading here.

The killers, according to a source with contacts in the anti-Castro movement, are coming from Florida armed with guns and explosives.

While police here were making plans for guarding Castro, several Cuban groups in New Jersey were readying another protest to greet the island dictator.

"This time, we only have a short time, so we hope people will hear about the rally on radio and in news papers," said Elsa Ybarra, a leader of the anti-Castro Alpha 66 in Elizabeth.

Last Friday some 3500

Cuban exiles staged a demonstration at the UN even after learning that there was no truth to a rumor that the Cuban leader would come that day.

In Hudson County, which has the second largest Cuban exile population after Miami, most stores shut in honor of the protest.

Mrs. Ybarra said the protest would be peaceful.

"We would never attempt to make violence in this country. We look to Cuba for a guerrilla attack. We would like to fight inside our own country."

But she added that some exiles did not feel that the U.S. is off-limits as far as violence is concerned.

"Everyone has his own idea about the war in Cuba," she said.

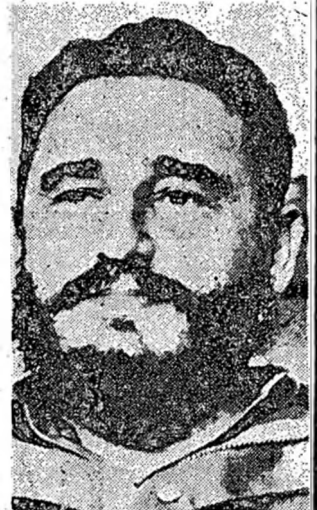

FIDEL CASTRO
A high-risk visitor.

185-734-39

SEARCHED INDEXED
SERIALIZED FILED

OCT 15 1979



b6
b7c

Fidel trip a security nightmare

From Tribune Wire Services

NEW YORK—American and United Nations authorities faced a security nightmare Tuesday as they prepared for Cuban President Fidel Castro's first visit to the UN in 19 years.

Top officials planned a huge police operation to ensure Castro's safety.

Castro arrives Wednesday, and informed sources said an advance guard of Cuban security agents was already in New York City after published reports that threats had been made on Castro's life.

One source said, "It will be one of the toughest security problems in the history of the United Nations."

UN Secretary-General Kurt Waldheim will review security plans with his aides, who held day-long consultations with the U.S. Secret Service, the Federal Bureau of Investigation, and New York police officials on Monday.

SEVERAL THREATS on Castro's life have been reported, and Waldheim may order the UN headquarters sealed off for the visit, with only persons holding official passes permitted to enter.

It has not been announced where the Cuban president will stay in New York or when he will address the General Assembly.

The details of his visit are being worked out by the UN and a Cuban advance party.

Thousands of Cuban exiles demonstrated outside the UN last week against the Castro government and are expected to return when he makes his speech.

It will be Castro's first visit since he took part in the 1960 summit session of the assembly when Soviet Premier Nikita Khrushchev amazed delegates by banging on his desk with his shoe.

185-734-40

SEARCHED	INDEXED
SERIALIZED	FILED

OCT 15 1979

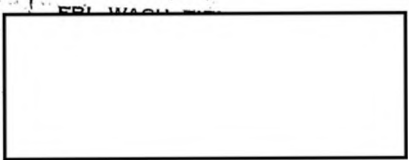

b6
b7c

FEDERAL BUREAU OF INVESTIGATION
FOI/PA
DELETED PAGE INFORMATION SHEET
FOI/PA# 1362425-000

Total Deleted Page(s) = 289

Page 5 ~ Duplicate;
Page 6 ~ Duplicate;
Page 7 ~ Duplicate;
Page 8 ~ Duplicate;
Page 9 ~ Duplicate;
Page 10 ~ Duplicate;
Page 11 ~ Duplicate;
Page 12 ~ Duplicate;
Page 14 ~ Duplicate;
Page 15 ~ Duplicate;
Page 16 ~ Duplicate;
Page 17 ~ Duplicate;
Page 18 ~ Duplicate;
Page 19 ~ Duplicate;
Page 20 ~ Duplicate;
Page 21 ~ Duplicate;
Page 22 ~ Duplicate;
Page 23 ~ Duplicate;
Page 24 ~ Duplicate;
Page 25 ~ Duplicate;
Page 26 ~ Duplicate;
Page 27 ~ Duplicate;
Page 28 ~ Duplicate;
Page 29 ~ Duplicate;
Page 30 ~ Duplicate;
Page 31 ~ Duplicate;
Page 32 ~ Duplicate;
Page 33 ~ Duplicate;
Page 34 ~ Duplicate;
Page 35 ~ Duplicate;
Page 36 ~ Duplicate;
Page 37 ~ Duplicate;
Page 38 ~ Duplicate;
Page 39 ~ Duplicate;
Page 40 ~ Duplicate;
Page 41 ~ Duplicate;
Page 42 ~ Duplicate;
Page 43 ~ Duplicate;
Page 44 ~ Duplicate;
Page 45 ~ Duplicate;
Page 46 ~ Duplicate;
Page 47 ~ Duplicate;
Page 48 ~ Duplicate;
Page 49 ~ Duplicate;
Page 50 ~ Duplicate;
Page 51 ~ Duplicate;
Page 52 ~ Duplicate;
Page 53 ~ Duplicate;
Page 54 ~ Duplicate;
Page 55 ~ Duplicate;
Page 56 ~ Duplicate;
Page 57 ~ Duplicate;
Page 58 ~ Duplicate;
Page 59 ~ Duplicate;
Page 60 ~ Duplicate;
Page 61 ~ Duplicate;
Page 62 ~ Duplicate;
Page 63 ~ Duplicate;
Page 64 ~ Duplicate;
Page 65 ~ Duplicate;
Page 66 ~ Duplicate;
Page 67 ~ Duplicate;
Page 68 ~ Duplicate;
Page 69 ~ Duplicate;
Page 70 ~ Duplicate;
Page 71 ~ Duplicate;
Page 75 ~ b6; b7C; b7E;

Page 76 ~ b6; b7C; b7E;
Page 77 ~ b6; b7C; b7E;
Page 78 ~ b6; b7C; b7E;
Page 79 ~ b6; b7C; b7E;
Page 80 ~ b6; b7C; b7E;
Page 81 ~ b6; b7C; b7E;
Page 82 ~ b6; b7C; b7E;
Page 83 ~ b6; b7C; b7E;
Page 84 ~ b6; b7C; b7E;
Page 85 ~ b6; b7C; b7E;
Page 86 ~ b6; b7C; b7E;
Page 87 ~ b6; b7C; b7E;
Page 88 ~ b6; b7C; b7E;
Page 89 ~ b6; b7C; b7E;
Page 90 ~ b6; b7C; b7E;
Page 91 ~ b6; b7C; b7E;
Page 92 ~ b6; b7C; b7E;
Page 94 ~ Duplicate;
Page 95 ~ Duplicate;
Page 96 ~ Duplicate;
Page 97 ~ Duplicate;
Page 98 ~ Duplicate;
Page 99 ~ Duplicate;
Page 100 ~ Duplicate;
Page 101 ~ Duplicate;
Page 102 ~ Duplicate;
Page 103 ~ Duplicate;
Page 104 ~ Duplicate;
Page 105 ~ Duplicate;
Page 106 ~ Duplicate;
Page 107 ~ Duplicate;
Page 108 ~ Duplicate;
Page 109 ~ Duplicate;
Page 110 ~ Duplicate;
Page 111 ~ Duplicate;
Page 112 ~ Duplicate;
Page 113 ~ Duplicate;
Page 114 ~ Duplicate;
Page 115 ~ Duplicate;
Page 116 ~ Duplicate;
Page 117 ~ Duplicate;
Page 118 ~ Duplicate;
Page 119 ~ b3; b6; b7C; b7E;
Page 120 ~ b3; b6; b7C; b7E;
Page 121 ~ b3; b6; b7C; b7E;
Page 122 ~ b3; b6; b7C; b7E;
Page 123 ~ b3; b6; b7C; b7E;
Page 124 ~ Duplicate;
Page 125 ~ Duplicate;
Page 126 ~ Duplicate;
Page 127 ~ Duplicate;
Page 128 ~ Duplicate;
Page 129 ~ Duplicate;
Page 130 ~ Duplicate;
Page 131 ~ Duplicate;
Page 132 ~ b3; b6; b7C; b7E;
Page 133 ~ b3; b6; b7C; b7E;
Page 134 ~ b3; b6; b7C; b7E;
Page 139 ~ Duplicate;
Page 140 ~ Duplicate;
Page 141 ~ Duplicate;
Page 149 ~ Duplicate;
Page 150 ~ Duplicate;
Page 151 ~ Duplicate;
Page 152 ~ Duplicate;
Page 153 ~ Duplicate;
Page 154 ~ Duplicate;
Page 155 ~ Duplicate;
Page 156 ~ Duplicate;
Page 157 ~ Duplicate;
Page 158 ~ Duplicate;
Page 159 ~ Duplicate;
Page 160 ~ Duplicate;

Page 161 ~ Duplicate;
Page 162 ~ Duplicate;
Page 163 ~ Duplicate;
Page 164 ~ Duplicate;
Page 165 ~ Duplicate;
Page 166 ~ Duplicate;
Page 167 ~ Duplicate;
Page 168 ~ Duplicate;
Page 169 ~ Duplicate;
Page 170 ~ Duplicate;
Page 171 ~ Duplicate;
Page 172 ~ Duplicate;
Page 173 ~ Duplicate;
Page 174 ~ Duplicate;
Page 175 ~ Duplicate;
Page 176 ~ Duplicate;
Page 177 ~ Duplicate;
Page 178 ~ Duplicate;
Page 179 ~ Duplicate;
Page 180 ~ Duplicate;
Page 181 ~ Duplicate;
Page 182 ~ Duplicate;
Page 183 ~ Duplicate;
Page 184 ~ Duplicate;
Page 185 ~ Duplicate;
Page 186 ~ Duplicate;
Page 187 ~ Duplicate;
Page 188 ~ Duplicate;
Page 189 ~ Duplicate;
Page 190 ~ Duplicate;
Page 191 ~ Duplicate;
Page 192 ~ Duplicate;
Page 193 ~ Duplicate;
Page 194 ~ Duplicate;
Page 195 ~ Duplicate;
Page 196 ~ Duplicate;
Page 197 ~ Duplicate;
Page 198 ~ Duplicate;
Page 199 ~ Duplicate;
Page 200 ~ Duplicate;
Page 201 ~ Duplicate;
Page 202 ~ Duplicate;
Page 203 ~ Duplicate;
Page 204 ~ Duplicate;
Page 205 ~ Duplicate;
Page 206 ~ Duplicate;
Page 207 ~ Duplicate;
Page 208 ~ Duplicate;
Page 209 ~ b6; b7C; b7E;
Page 210 ~ b6; b7C; b7E;
Page 212 ~ b6; b7C; b7E;
Page 213 ~ Duplicate;
Page 214 ~ Duplicate;
Page 215 ~ Duplicate;
Page 216 ~ Duplicate;
Page 217 ~ Duplicate;
Page 218 ~ Duplicate;
Page 219 ~ Duplicate;
Page 220 ~ Duplicate;
Page 221 ~ Duplicate;
Page 222 ~ Duplicate;
Page 223 ~ Duplicate;
Page 227 ~ b3; b7D; b7E;
Page 228 ~ b3; b7D; b7E;
Page 233 ~ Duplicate;
Page 234 ~ Duplicate;
Page 237 ~ Duplicate;
Page 238 ~ Duplicate;
Page 239 ~ Duplicate;
Page 240 ~ Duplicate;
Page 241 ~ Duplicate;
Page 242 ~ Duplicate;
Page 243 ~ Duplicate;

Page 244 ~ Duplicate;
Page 245 ~ Duplicate;
Page 246 ~ Duplicate;
Page 247 ~ Duplicate;
Page 248 ~ Duplicate;
Page 249 ~ Duplicate;
Page 250 ~ Duplicate;
Page 251 ~ Duplicate;
Page 252 ~ Duplicate;
Page 253 ~ Duplicate;
Page 256 ~ Duplicate;
Page 259 ~ b3; b6; b7C; b7D; b7E;
Page 260 ~ b3; b6; b7C; b7D; b7E;
Page 261 ~ b3; b6; b7C; b7D; b7E;
Page 262 ~ b3; b6; b7C; b7D; b7E;
Page 266 ~ Duplicate;
Page 267 ~ Duplicate;
Page 268 ~ Duplicate;
Page 269 ~ Duplicate;
Page 272 ~ Duplicate;
Page 273 ~ Duplicate;
Page 275 ~ Duplicate;
Page 276 ~ Duplicate;
Page 277 ~ Duplicate;
Page 278 ~ Duplicate;
Page 279 ~ Duplicate;
Page 280 ~ Duplicate;
Page 281 ~ Duplicate;
Page 282 ~ Duplicate;
Page 283 ~ Duplicate;
Page 284 ~ Duplicate;
Page 285 ~ Duplicate;
Page 286 ~ Duplicate;
Page 288 ~ b3; b6; b7C; b7D; b7E;
Page 289 ~ b3; b6; b7C; b7D; b7E;
Page 290 ~ b3; b6; b7C; b7D; b7E;
Page 292 ~ Duplicate;
Page 293 ~ Duplicate;
Page 298 ~ Duplicate;
Page 299 ~ Duplicate;
Page 300 ~ Duplicate;
Page 310 ~ Duplicate;
Page 313 ~ b3; b6; b7C; b7D; b7E;
Page 317 ~ Duplicate;
Page 318 ~ Duplicate;
Page 319 ~ Duplicate;
Page 320 ~ Duplicate;
Page 321 ~ Duplicate;
Page 322 ~ Duplicate;
Page 323 ~ Duplicate;
Page 324 ~ Duplicate;
Page 325 ~ Duplicate;
Page 326 ~ Duplicate;
Page 327 ~ Duplicate;
Page 328 ~ Duplicate;
Page 329 ~ Duplicate;
Page 330 ~ Duplicate;
Page 331 ~ Duplicate;
Page 332 ~ Duplicate;
Page 333 ~ Duplicate;
Page 334 ~ Duplicate;
Page 335 ~ Duplicate;
Page 336 ~ Duplicate;
Page 337 ~ Duplicate;
Page 338 ~ Duplicate;
Page 339 ~ Duplicate;
Page 340 ~ Duplicate;
Page 341 ~ Duplicate;
Page 342 ~ Duplicate;
Page 343 ~ Duplicate;
Page 344 ~ Duplicate;
Page 345 ~ Duplicate;
Page 346 ~ Duplicate;

Page 347 ~ Duplicate;
Page 349 ~ Duplicate;
Page 350 ~ Duplicate;

XXXXXXXXXXXXXXXXXXXXXXXXXXXX
X Deleted Page(s) X
X No Duplication Fee X
X For this Page X
XXXXXXXXXXXXXXXXXXXXXXXXXXXX

Memorandum

TO : SAC (185-899)

DATE: 10/9/79

FROM : SA (M-10)

b6
b7C

SUBJECT: CAZVIZ
PFO
(OO: NY)

It is expected that a large volume of threats will be received in connection with the CASTRO visit.

It is requested that a Sub A file be established for administrative purposes.

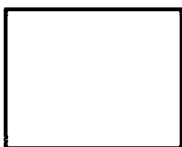

b6
b7C

1 - 185-899 Sub A



(2)
M-10

185-899-53
SEARCHED _____ INDEXED _____
SERIALIZED _____ FILED _____
OCT 10 1979
FBI - NEW YORK

b6
b7C

VZCZCHQ0919

CO BQ NR NY

DE HQ 0128 2840154

ZNY CCCCC

O 102332Z OCT 79

FM DIRECTOR FBI

TO FBI BROOKLYN-QUEENS IMMEDIATE

FBI NEW ROCHELLE IMMEDIATE

~~FBI NEW YORK IMMEDIATE~~

BT

~~CONFIDENTIAL~~

BY TELETYPE OCTOBER 10, 1979, U. S. INTEREST SECTION,
HAVANA, ADVISED:

CUBAN AUTHORITIES HAVE JUST ADVISED US THAT PRESIDENT
CASTRO WILL TRAVEL TO NEW YORK ABOARD THE SPECIAL
CUBANA FLIGHT DEPARTING HAVANA AT 2000 THIS EVENING (OCT 10),
ARRIVING NY AT APPROXIMATELY 0100 (OCT 11).

PLS ADVISE ALL NECESSARY AUTHORITIES.

~~C AND E 4478, REASON 1, DRD OCTOBER 10, 2009.~~

BT

0128

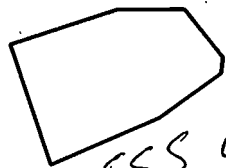
USSS advised

185-899-54

SEARCHED	[REDACTED]
SERIALIZED	[REDACTED]
OCT 10 1979	
[REDACTED]	[REDACTED]

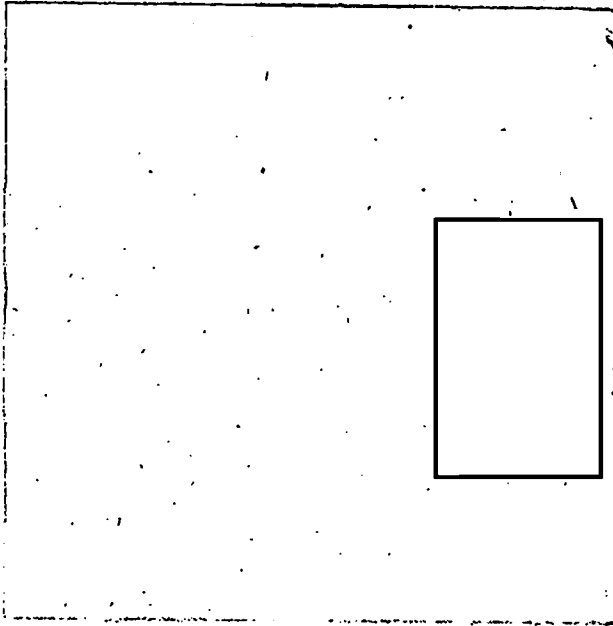

b6
b7C

185- 899-69

SEARCHED	INDEXED
SERIALIZED	FILED
FBI - NEW YORK	
[Redacted]	

b6
b7c



na family: (standing) father Antonio, mother Sira, Bebe, Tony; (front) Victoria, Carlos, Ana

LY, from 1A

always said, and of fight.

thing tragic will happen. Possibility but a probability adjust your life according to a defense mechanism absorber, similar to camouflage ability.

to the United States in flew to New York in and waited several days for my father, who escaped with my grandmother on a boat. When he was in the rest of the family was 4 and he 29.

of my childhood often so there is no clear that may have led to my father from an assassin's bullet not one event to pin-

point or to blame for this acceptance. It's a mixture of things, from a ridiculously idealistic belief that everything will be all right, to faith in God, to a feeling that some kind of immunity develops after repeated incidents.

The shooting Friday was not my father's only brush with death because of politics. But it was the closest. You would expect him to shy away from the public and from the press but the same night as the shooting he was granting interviews, and two days later he was back at work.

"You've got to stand up to these people, stare them in the eye and show them there is nothing to be afraid of," he is fond of saying.

The rest of the family takes its cue from him. And didn't I notice a

straightening up of my 23-year-old brother Tony's shoulder, a lifting of Victoria's chin?

Thanks to violence and danger, we have learned what few people know: that humor is essential. When you lose the ability to laugh at yourself, you lose every chance of survival, of triumph. Jokes, which may seem tactless to an outsider, are common at home.

My father: "I have an angel under contract, that's why I have been so lucky. Lately, he's been talking about unionization and I think he's been goofing off on the job."

My mother: "Your left sideburn will probably never grow again, but you were lucky. If the bullet had hit you any higher, you might have had to get a toupee."

Despite my father's involvement in the maelstrom of Cuban politics, we have led a very normal life — on Cuban terms. We prayed to Our Lady of Charity (the patron saint of Cuba), we spoke Spanglish at home and fought — successfully — to leave the chaperones at home.

But there were differences. I learned how to pass out political literature and recite patriotic poems before the third grade. Unlike most of the Cuban-Americans my age, I know Cuba's history quite well. I learned it in the early '60s in the offices of Alpha 66 (an anti-Castro

exile group co-founded by my father) from the wives of imprisoned anti-Castro leaders.

My American friends never understood the politics or the violence that comes with Cuban politics. To this day I have not been able to explain, but only to describe, the passion Cubans feel for the freedom that's taken for granted in this country.

These aberrations from "normal life" have left their marks. All the children are friendly but have few close friends. Mother has a skin disease in which parts of skin stop producing melanin, skin pigment, causing white spots to appear over her body. Do attribute it to "nerves."

And, of course, there is all the nagging question of if when.

But fear? Never. The fear I know, if it can be rightly called that, is the fear many others are fortunate enough to experience.

I fear that we may have forgotten why we are here.

I fear that we have grown placid and smug.

I fear the satisfaction that comes from having three cars in the driveway and a chicken in every pot knowing we can say what we will please without valuing freedom.

That's what I fear.

Police seek shooting motive

Police are investigating the murder of Antonio Veclana, former leader of the militant organization Alpha 66.

Police are trying to find a motive for the shooting, which occurred last week as Veclana was driving from his office at 1980 NW

the basis for police checks of "drug relationships."

The FBI told Veclana it is investigating the shooting because of a possible connection with agents of a foreign government, Veclana says. Veclana and his friends say they believe the shooting was by agents of the Cuban government.

Veclana, a non-active member of Alpha 66, was turning the corner at NW 17th Street and NW 29th Avenue when a brown 1971 Buick station wagon pulled alongside him. Four shots were fired from the car.

Investigators are looking into the political circumstances and drug relationships," said spokesman Calvin Ross. There are no new leads, no sus-

Exile leader's children live with danger and pride

Fear is the mind killer. Fear is the little death that brings total obliteration. I will face my fear. I will permit it to pass over me and through me. And when it has gone past me, I will turn to see fear pass. Where the fear has gone, there will be nothing. Only I will remain.

Frank Herbert, from the novel "Dune," 1965

ANA VECIANA
Miami News Reporter

Nearing midnight last Saturday, Mother noticed the light in the children's bedroom. She peeked in, expecting to find Carlos and Bebe quietly sleeping with the musical Winnie the Pooh and Tete, the hand-me-down stuffed monkey.

Instead, she found two wide-eyed children huddled in one twin bed.

"You're still awake?" she asked.

"We can't get to sleep," said Carlos, 8.

"Well, let me turn off the light. You'll sleep better in the dark."

The children whimpered. The night before, they had seen our father, Antonio Veciana, a vociferous anti-Castro leader, stumble into the house, blood spattered over his clothes, a bullet in his head.

Bebe, 6, had a right to pull the Mickey Mouse-print sheets over her head and whisper tremulously, "I'm scared. Don't turn off the light."

And Mother had as much right to reply, "You must be kidding. A Veciana scared? Come now, you know better than that. Go to sleep."

She turned off the light. And that was that.

Carlos and Bebe, my youngest brother and sister, are learning to deal with fear at an early age — the same fear their older siblings dealt with at an earlier age. In a matter of months, they'll find that fear is a luxury they cannot afford. And by the time they finish elementary school, the thought of death by politics won't be frightening.

★ ★ ★ ★ ★

When Father was shot and wounded last Friday as he drove home from work, I found out 10 minutes later by a phone call from the middle sister, Victoria. (Perhaps one of life's great ironies is that I was the reporter who wrote the story about the shooting for The Miami News. A subtler irony — and a standing joke at home — is that Victoria, 20, was named for Castro's revolution, the same revolution my father is now fighting to defeat.)

As the news of the shooting spread, an acquaintance stopped by to find out how the family was taking it. "How are you holding up?" she asked.

"Okay. How else?" I said.

"Well, aren't you scared? Jesus, your father could have gotten killed. You could have gotten killed. All of you could have gotten killed."

"But we didn't."

And that, I think, is that. We're still alive. Today. Tomorrow is tomorrow. You can't live with fear.

See FAMILY, 4A

EDITOR'S NOTE: Miami News Reporter Ana Veciana, 22, is a graduate of the University of South Florida and has been writing for The Miami News for the past year and a half. As the child of a Cuban exile family headed by a man long active in anti-Castro politics, she has grown up with concerns — and opportunities — that many Americans never face. Here she writes about coming to terms with the violence that has punctuated exile politics.



Veciana

VZCZCWF00034

RR HI NY

DE WF

ZNR UUUUU

R 110330Z OCT 79

FM WASHINGTON FIELD (185-NEW)

TO DIRECTOR, FBI ROUTINE

SAC, NEW YORK (INFO) ROUTINE

BT

U N C L A S

UNSUB; THREAT TO BOMB CUBAN BUILDING, WASHINGTON, D.C.,
OCTOBER 11, 1979, PFC-BOMB THREAT

AT 9:20 P.M., SERGEANT [REDACTED] METROPOLITAN POLICE
DEPARTMENT (MPD) ADVISED THAT THE WASHINGTON POST HAD RECEIVED
AN ANONYMOUS BOMB THREAT AGAINST A CUBAN BUILDING IN
WASHINGTON, D.C. (WDC). HE ADDED THE EXECUTIVE PROTECTIVE
SERVICE HAD BEEN NOTIFIED AND THE PROPER SECTION OF MPD
HAD ALSO BEEN NOTIFIED.

b6
b7C

AT 9:25 P.M., [REDACTED] SWITCHBOARD OPERATOR,
WASHINGTON POST, ADVISED SHE HAD RECEIVED THREE PHONE CALLS
FROM AN ANONYMOUS FEMALE AT APPROXIMATELY 9:00 P.M. TODAY.
DURING THE FIRST TWO CALLS ALL THE CALLER MANAGED TO SAY WAS
"HELP" BEFORE EITHER BEING DISCONNECTED OR HANGING UP.

b6
b7C

[REDACTED]

[REDACTED]

[REDACTED]

185-879-82
SEARCHED
OCT 21 1979
[REDACTED]

b6
b7C

DURING THE THIRD CALL THE CALLER STATED "HELP ME QUICK. A BOMB. CUBAN BUILDING, WASHINGTON." AT THIS POINT [REDACTED] ATTEMPTED TO TRANSFER THE CALL TO THE NEWSROOM, BUT THE CALLER TERMINATED THE CALL. [REDACTED] STATED THAT THE FEMALE CALLER WAS EXTREMELY DISTRAUGHT, CRYING, AND HYSTERICAL DURING THE THREE CALLS. SHE STATED THE CALLER SPOKE VERY BROKEN ENGLISH WITH WHAT SHE THOUGHT WAS A ROMANCE LANGUAGE ACCENT. SHE ADDED THE CALLER'S VOICE DID NOT SOUND AS IF THE CALLER WAS EITHER VERY YOUNG OR VERY OLD. SHE COULD DETECT NO BACKGROUND NOISES OR ANYTHING ELSE OF AN IDENTIFYING NATURE DURING THE CALLS. [REDACTED] ADDED THAT SHE HAD RECEIVED THE CALLS ON THE POST'S INCOLLECT WATTS LINE, (800) 424-9276 OR 7. SHE STATED THIS NUMBER CAN ONLY BE CALLED FROM PENNSYLVANIA, NEW JERSEY, VIRGINIA, WEST VIRGINIA, AND DELAWARE. THIS NUMBER IS DISTRIBUTED TO ANYONE IN THESE AREAS WHO MAY NEED TO CONTACT THE POST IN WASHINGTON CONCERNING CIRCULATION OR ADVERTISING MATTERS. [REDACTED] CAN BE REACHED AT THE POST'S SWITCHBOARD, 484-5000.

AT APPROXIMATELY 9:45 P.M., [REDACTED] UNITED STATES

b6
b7c

b6
b7c

b6
b7c

PAGE THREE DE WF 0034 U N C L A S

SECRET SERVICE, INTELLIGENCE DIVISION, [REDACTED]
WATCH OFFICER, OPERATIONS CENTER, UNITED STATES DEPARTMENT
OF STATE (USDS), AND [REDACTED] WATCH OFFICER, COMMAND
CENTER, USDS, WERE FURNISHED WITH THE ABOVE INFORMATION.

b6
b7c

BT

0034

NNNN

0209HQ0949 2842143

PP NY 146

DE HQ 0258

ZNY SSSSS

P 111620Z OCT 79

FM DIRECTOR FBI

TO FBI NEW YORK PRIORITY

FBI MIAMI PRIORITY

BT

~~SECRET~~

[REDACTED]

b3
b6
b7C
b7E

FOLLOWING FURNISHED BY MIAMI TEL OCTOBER 11, 1979:

FOR THE INFORMATION OF THE BUREAU, AT APPROXIMATELY 8:00
A.M., ON OCTOBER 10, 1979, [REDACTED] WAS TAKEN
INTO CUSTODY BY OFFICERS OF THE DADE COUNTY PUBLIC SAFETY
DEPARTMENT (DCPSD) AT THE MIAMI INTERNATIONAL AIRPORT (MIA)
DURING A ROUTINE X-RAY LUGGAGE INSPECTION, AT WHICH TIME A
FULLY LOADED REVOLVER WAS DISCOVERED IN HIS BRIEFCASE.

b6
b7C

[REDACTED] WAS TRANSPORTED TO THE DCPSD SUBSTATION LOCATED AT
THE MIA AT WHICH TIME THE MIAMI OFFICE WAS ADVISED OF HIS ARREST.
HE HAD BEEN ATTEMPTING TO BOARD AN EASTERN AIRLINES FLIGHT

[REDACTED]

185-899-84
SEARCHED
SERIALIZED
OCT 11 1979
[REDACTED]

b6
b7C

(NUMBER 895) FROM MIAMI TO NEW YORK CITY. SUBJECT WAS INTERVIEWED BY BUREAU AGENTS AT THE ABOVE SUBSTATION DURING WHICH INTERVIEW HE REFUSED TO COOPERATE WITH INTERVIEWING AGENTS, DEMANDED TO SEE HIS LAWYER, AND REFUSED TO PROVIDE ANY INFORMATION AS TO WHY THE REVOLVER WAS IN HIS LUGGAGE. (U)

AUSA [REDACTED] WAS CONTACTED AND REQUESTED FURTHER INVESTIGATION PRIOR TO RENDERING A PROSECUTIVE OPINION. [REDACTED] REQUESTED THAT THE SUBJECT BE BROUGHT TO THE MIAMI OFFICE OF THE FBI FOR FURTHER INTERVIEW [REDACTED]

b5
b6
b7C

[REDACTED] WAS INFORMED THAT THE

SUBJECT IS [REDACTED]

[REDACTED] (U)

SUBJECT INFORMED BUREAU AGENTS THAT HE WAS EN ROUTE TO NEW YORK CITY TO ASSIST IN THE OVERALL SECURITY PROGRAM IN CONNECTION WITH THE VISIT OF FIDEL CASTRO TO THE UNITED NATIONS. ~~(S)~~ (U)

AT 11:00 A.M., AUSA [REDACTED] ADVISED THAT HE HAD CONFERRED WITH THE U.S. MAGISTRATE FOR THE SOUTHERN DISTRICT OF FLORIDA, AND IT WAS THEIR OPINION THAT THE SUBJECT SHOULD NOT BE

b6
b7C

185-599-884

PAGE THREE DE HQ 2658 ~~SECRET~~

PROSECUTED FEDERALLY AND THAT PROSECUTION SHOULD BE DEFERRED TO LOCAL AUTHORITIES [REDACTED]

b5

[REDACTED] (U)

BASED ON THIS DECISION BY AUSA [REDACTED] WAS RELEASED FROM THE MIAMI OFFICE. AUSA [REDACTED] REQUESTED THAT THE MIAMI OFFICE CONFISCATE SUBJECT'S WEAPON AND THAT THE U.S. SECRET SERVICE BE IMMEDIATELY NOTIFIED OF THIS INCIDENT. (U)

b6
b7C

NCIC NEGATIVE RE WEAPON AND SUBJECT. (U)

~~C AND E BY 5236, REASON 2, DRD OCTOBER 11, 1999.~~

ADMINISTRATIVE

FOR THE FURTHER INFORMATION OF INTD, UPON ARREST BY LOCAL AUTHORITIES, [REDACTED] IMMEDIATELY REQUESTED INTERVIEW BY MIAMI SUPERVISORS [REDACTED] IN VIEW OF HIS PAST CONTACT WITH THOSE AGENTS. PROCESSING OF THE SUBJECT WAS HANDLED IN SUCH A MANNER THAT [REDACTED] UNDOUBTEDLY CREDITS MIAMI SUPERVISORS [REDACTED] WITH INTERCESSION ON HIS BEHALF WITH THE U.S. ATTORNEY'S OFFICE, [REDACTED]

b5
b6
b7C

[REDACTED] DURING INTERVIEW AT FBI OFFICE, [REDACTED] ACKNOWLEDGED THAT HE HAD BEEN SUMMONED TO NEW YORK CITY BY A TELEPHONE CALL FROM THE- 594 84

b6
b7C

CUBAN MISSION TO THE UNITED NATIONS TO ASSIST WITH THE SECURITY ARRANGEMENTS FOR PRESIDENT FIDEL CASTRO IN THAT CITY. HE INDICATED THAT FIDEL CASTRO WOULD ARRIVE IN NEW YORK ON THE EVENING OF OCTOBER 10, 1979, AND WOULD REMAIN IN NEW YORK AT LEAST FOUR DAYS AND POSSIBLY LONGER, DURING WHICH TIME CASTRO PLANS TO VISIT PROMINENT DEPARTMENT STORES ON 5TH AVENUE, YANKEE STADIUM, AND A TOUR THROUGH HARLEM. [REDACTED] FURTHER STATED THAT [REDACTED] WOULD ACCOMPANY CASTRO TO NEW YORK CITY AND THAT [REDACTED] HAS INVITED [REDACTED] TO VISIT IN MIAMI ON HIS RETURN TO HAVANA. UPON LEAVING THE FBI OFFICE AT APPROXIMATELY 12 NOON, [REDACTED] WAS PLANNING TO OBTAIN IMMEDIATE AIR TRANSPORTATION TO NEW YORK CITY FOR CONTACT WITH CUBAN SECURITY FORCES. FBIHQ WILL BE KEPT ADVISED OF ANY FURTHER DETAILS OBTAINED IN THIS MATTER. ~~(S)~~ (U)

b6
b7C

FOR INFORMATION WASHINGTON FIELD OFFICE, NEW YORK OFFICE,

[REDACTED] WASHINGTON

FIELD OFFICE, NEW YORK OFFICE REQUESTED TO [REDACTED]

b6
b7C
b7E

[REDACTED]

~~(S)~~ (U)

BT

0058

155-50 84

b6
b7C

PP BQ NY

DE HQ 0064 2842113

ZNY SSSSS

P 111642Z OCT 79

FM DIRECTOR FBI

TO RUEHBE/U. S. SECRET SERVICE (PID)

RUEGGBA/FEDERAL AVIATION ADMINISTRATION

FBI BROOKLYN/QUEENS PRIORITY

FBI NEW YORK PRIORITY

BT

~~SECRET~~

[REDACTED]

CAA-CARRYING A DEADLY WEAPON (A)

b3
b6
b7C
b7E

(OC: MIAMI)

[REDACTED]

BY TELETYPE OCTOBER 10, 1979, FBI, MIAMI, FURNISHED THE
FOLLOWING INFORMATION:

AT APPROXIMATELY 8:00 A. M., ON OCTOBER 10, 1979, [REDACTED]

[REDACTED]

WAS TAKEN INTO CUSTODY BY OFFICERS OF THE DADE
COUNTY PUBLIC SAFETY DEPARTMENT (LCPD) AT THE MIAMI
INTERNATIONAL AIRPORT (MIA) DURING A ROUTINE X-RAY LUGGAGE

b6
b7C

[REDACTED]

185-899-85
SEARCHED
SERIAL
OCT 11 1979
[REDACTED]

b6
b7C

INSPECTION, AT WHICH TIME A DULLY LOADED REVOLVER WAS DISCOVERED IN HIS BRIEFCASE. [REDACTED] WAS TRANSPORTED TO THE DCPSD SUBSTATION LOCATED AT THE MIA AT WHICH TIME THE MIAMI OFFICE WAS ADVISED OF HIS ARREST. HE HAD BEEN ATTEMPTING TO BOARD AN EASTERN AIRLINES FLIGHT (NUMBER 895) FROM MIAMI TO NEW YORK CITY. SUBJECT WAS INTERVIEWED BY BUREAU AGENTS AT THE ABOVE SUBSTATION DURING WHICH INTERVIEW HE REFUSED TO COOPERATE WITH INTERVIEWING AGENTS, DEMANDED TO SEE HIS LAWYER, AND REFUSED TO PROVIDE ANY INFORMATION AS TO WHY THE REVOLVER WAS IN HIS LUGGAGE.

b6
b7C

AUSA [REDACTED] WAS CONTACTED AND REQUESTED FURTHER INVESTIGATION PRIOR TO RENDERING A PROSECUTIVE OPINION. [REDACTED] REQUESTED THAT THE SUBJECT BE BROUGHT TO THE MIAMI OFFICE OF THE FBI FOR FURTHER INTERVIEW [REDACTED]

b5
b6
b7C

[REDACTED] WAS INFORMED THAT THE [REDACTED]

SUBJECT INFORMED BUREAU AGENTS THAT HE WAS EN ROUTE TO NEW YORK CITY TO ASSIST IN THE OVERALL SECURITY PROGRAM IN CONNECTION WITH THE VISIT OF FIDEL CASTRO TO THE UNITED STATES

185-899

85
[REDACTED]

b6
b7C

[REDACTED]

PAGE THREE DE RUEHFB 0064 ~~SECRET~~

NATIONS.

AT 11:00 A.M., AUSA [] ADVISED THAT HE HAD CONFERRED WITH THE U.S. MAGISTRATE FOR THE SOUTHERN DISTRICT OF FLORIDA, AND IT WAS THEIR OPINION THAT THE SUBJECT SHOULD NOT BE PROSECUTED FEDERALLY AND THAT PROSECUTION SHOULD BE DEFERRED TO LOCAL AUTHORITIES []

b5
b6
b7C

[]
BASED ON THIS DECISION BY AUSA [] WAS RELEASED FROM THE MIAMI OFFICE. AUSA [] REQUESTED THAT THE MIAMI OFFICE CONFISCATE SUBJECT'S WEAPON AND THAT THE U.S. SECRET SERVICE BE IMMEDIATELY NOTIFIED OF THIS INCIDENT.

b6
b7C

NCIC. NEGATIVE RE WEAPON AND SUBJECT.

~~C AND E BY 1357, REASON 2, DRD OCTOBER 10, 1999.~~

BT

0064

185-809

85

[]

b6
b7C

THINGS TO DO TODAY!

Date: _____

Urgent
✓

Done
✓

- | | | |
|--------------------------|-----|--------------------------|
| <input type="checkbox"/> | 1. | <input type="checkbox"/> |
| <input type="checkbox"/> | 2. | <input type="checkbox"/> |
| <input type="checkbox"/> | 3. | <input type="checkbox"/> |
| <input type="checkbox"/> | 4. | <input type="checkbox"/> |
| <input type="checkbox"/> | 5. | <input type="checkbox"/> |
| <input type="checkbox"/> | 6. | <input type="checkbox"/> |
| <input type="checkbox"/> | 7. | <input type="checkbox"/> |
| <input type="checkbox"/> | 8. | <input type="checkbox"/> |
| <input type="checkbox"/> | 9. | <input type="checkbox"/> |
| <input type="checkbox"/> | 10. | <input type="checkbox"/> |

NOTES:

26 Federal Plaza
New York, New York 10007
October 22, 1979

Paul A. Scanlon
Special Agent in Charge
United States Secret Service
6 World Trade Center
United States Customhouse
Room 623
New York, New York 10048

Dear Paul:

I have been advised by Supervisor [redacted] of the outstanding cooperation given his squad by your Supervisor [redacted] and your Agents [redacted] and others during the recent visits of Pope John Paul II and Cuban Premier Fidel Castro. These visits afforded unique problems to both of our agencies. The unusual number of threatening calls, the countless interviews and inordinate amount of overtime all served to make these visits most difficult. It is gratifying that despite these factors, the visits passed with virtually no incidents of any consequence. This can be attributed to the degree of cooperation achieved by our agencies, and the dedication and aggressiveness of our personnel. Your men are most deserving of commendation. Please relay to them my thanks.

b6
b7c

Very truly yours,

NEIL J. WELCH
Assistant Director in Charge

- 3 - Addressee
- 1 - New York (185-893)
- ① - New York (185-899)

[redacted]

(5)

185-899-104

SEARCHED	INDEXED
SERIALIZED	FILED

OCT 29 1979

FBI - NY

[redacted]

b6
b7c

FBI

TRANSMIT VIA:

- Teletype
- Facsimile
- _____

PRECEDENCE:

- Immediate
- Priority
- Routine

CLASSIFICATION:

- TOP SECRET
- SECRET
- CONFIDENTIAL
- UNCLAS E F T O
- UNCLAS

Date 10/30/79

31

FM NEW YORK (185-899) (M-10)

TO DIRECTOR ROUTINE

BT

U N C L A S

CAZVIZ; PFO.

RENYTEL, OCTOBER 11, 1979 AND BUREAU TELETYPE, OCTOBER 19, 1979.

NYO SPECIAL AGENT INTERVIEWED [REDACTED] AND

[REDACTED] AT LENGTH ON OCTOBER 11, 1979, AND IT IS THE OPINION OF THE NYO THAT THEY ARE NOT INVOLVED IN ANY ANTI-CASTRO ACTIVITIES. RESULTS OF THAT INTERVIEW WERE FURNISHED IN REFERENCED NEW YORK TELETYPE.

b6
b7C

IN VIEW OF THE ABOVE, THE BUREAU IS REQUESTED TO ADVISE

[REDACTED] TO DISCONTINUE EFFORTS [REDACTED]
[REDACTED]

b6
b7C
b7D
b7E

NEW YORK IS PLACING THIS MATTER IS A CLOSED STATUS.

INVESTIGATION CONCERNING INFORMATION GATHERED DURING THIS CASE

WILL BE PERSUED THROUGH EXISTING ANTI-CASTRO BOMBING CASES. FILE STRIPPED BY [REDACTED] ON 11/8

- # 1-NEW YORK
- 1-SUPERVISOR # M-10
- 1-PROGRAM MANAGER,

ONE CLOSE [REDACTED] 185-899-105 [REDACTED] 1979

b6
b7C

Approved: (3) [REDACTED] M-10

Transmitted 40 (Number) 1439 (Time) Per [REDACTED]

[redacted]

b6
b7C

MM0003 2411744Z

PP HI LA NK NY SJ WF

DE MM

P 291744Z AUG 79

FM MIAMI [redacted] P

TO DIRECTOR PRIORITY

LOS ANGELES PRIORITY

NEWARK PRIORITY

NEW YORK PRIORITY

SAN JUAN PRIORITY (VIA WASHINGTON)

WASHINGTON FIELD PRIORITY

BT

~~CONFIDENTIAL~~

[redacted]

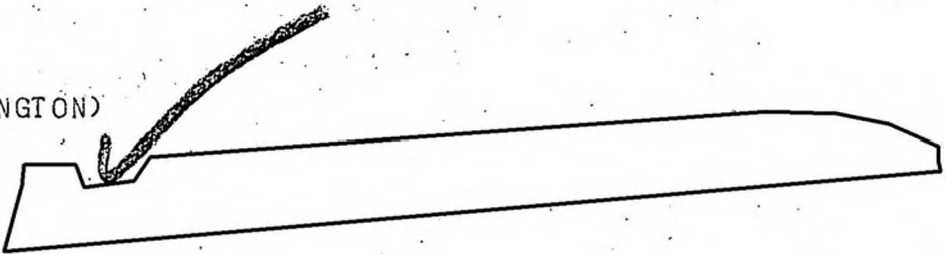

b3
b7E

b3
b7E

ON AUGUST 28, 1979, A CONFIDENTIAL SOURCE WHO HAS PROVIDED
RELIABLE INFORMATION IN THE PAST ADVISED AS FOLLOWS:

[Large redacted block]

b7D

185-899-106

cc to [redacted]

M-10

G-44

Stamp: AUG 29 1979
FBI-NEW Y [redacted]

b3
b6
b7C
b7E

[REDACTED]

~~C O N F I D E N T I A L~~

b3
b7E

THE SOURCE STATED THAT

[REDACTED]

[REDACTED]

b7D

THE SOURCE INDICATED THAT

[REDACTED]

[REDACTED]

b7D

ADMINISTRATIVE:

THE CONFIDENTIAL SOURCE IS

[REDACTED]

[REDACTED]

b6
b7C
b7D

IN ADDITION

[REDACTED]

[REDACTED]

THE MIAMI DIVISION WILL

ADVISE THE APPROPRIATE LOCAL AND FEDERAL AGENCIES OF THE POSSIBLE
THREAT TO SOUTHEAST AIRLINES AND TO FIDEL CASTRO IN NEW YORK CITY.

IN ADDITION, LIAISON WILL BE CONTINUED WITH SOUTHEAST AIRLINES
REGARDING THIS MATTER.

PAGE FIVE

~~CONFIDENTIAL~~

b3
b7E

NEW YORK ADVISE APPROPRIATE OFFICIALS IN SUCH A MANNER THAT
INFORMANT NOT BE COMPROMISED.

THE BUREAU IS REQUESTED TO DISSEMINATE THE FOREGOING TO
SECRET SERVICE, FAA AND OTHER APPROPRIATE AGENCIES AS DEEMED
ADVISABLE.

~~C&E BY 6034, REASONS 2&4, DRD AUGUST 28, 1999.~~

BT

2411753 NY 1

FEDERAL BUREAU OF INVESTIGATION



b6
b7C

Date of transcription 10/11/79

[redacted]
[redacted] was contacted at the residence of [redacted]
[redacted] advised as follows:

b6
b7C

[redacted]
[redacted] He came to New York City by air on October 2, 1979 for a planned Alpha 66 demonstration against the proposed visit of FIDEL CASTRO in New York. He and others are at the residence of [redacted] to coordinate the demonstration against CASTRO at the United Nations. [redacted] stated that he has no knowledge, past, present, or future, of violence against CASTRO or Cuba. Neither does he know any of the members of the Anti-CASTRO group, Omega 7, or anyone within the Anti-CASTRO movement who has weapons or explosives.

b6
b7C

[redacted] stated that he arrived from Cuba in New York City in 1968 [redacted] He is employed full time [redacted] for Alpha 66.

b6
b7C

The following information was obtained from observation and interview:

- Name
- Sex
- Race
- Nationality
- Date of Birth
- Place of Birth
- Address

- Height
- Weight
- Build
- Hair
- Arrived in US
- Alien Registration Number

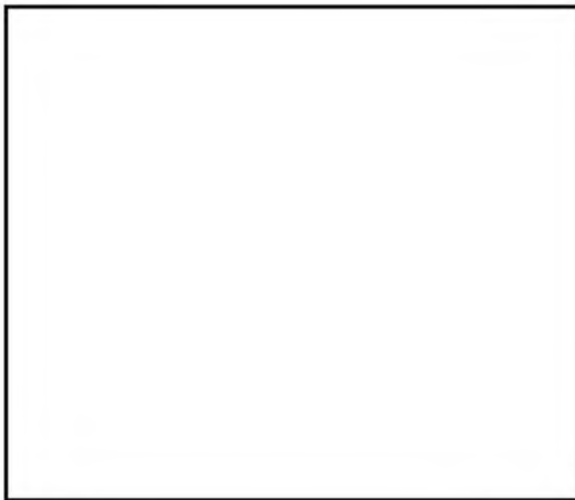

b6
b7C

Investigation on 10/4/79 at New York City, New York File # NY 185-899-107
by SA [redacted] Date dictated 10/11/79

b6
b7C

NY 185-899

Issued at New York
City
Vehicles



b6
b7c

FEDERAL BUREAU OF INVESTIGATION



Date of transcription 10/11/79

[redacted]
[redacted] was contacted at
the residence of [redacted]
[redacted] advised as follows:

b6
b7C

He and several other individuals were at the residence of [redacted] to coordinate a demonstration planned by the group Alpha 66 for the following day October 5, 1979. [redacted] stated he is a member of Alpha 66 and the planned demonstration is to protest against the proposed visit to the United States by Cuba's Premier FIDEL CASTRO. The demonstration will be peaceful consisting mainly of Anti-CASTRO placards, banners, and speeches. [redacted] stated that he has no knowledge of violence, past or future, nor does he know of anyone in the Anti-CASTRO group, Omega 7.

b6
b7C

[redacted] stated that he is a permanent resident of the United States having fled Cuba via Guantanamo Naval Base in 1970. He is employed at [redacted]
[redacted]

b6
b7C

The following was obtained from observation and interview:

b6
b7C

Name
Sex
Race
Nationality
DPOB
Address

Height
Weight
Build
Hair
Arrival in United States
Alien Registration Number
Issued at New York City

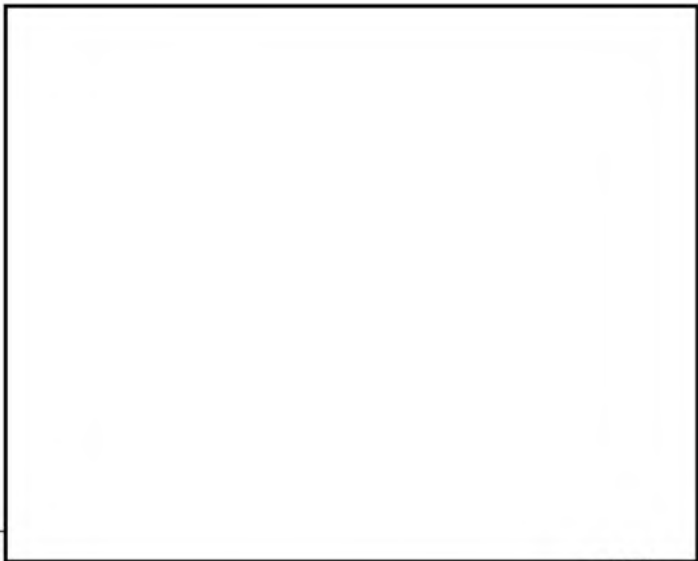

Investigation on 10/4/79 at New York, New York File # NY 185-899-108

by SA [redacted] Date dictated 10/11/79

b6
b7C

NY 185-899

Automobile
New York License



b6
b7C

Complaint Form
FD-71 (Rev. 8-29-74)

NOTE: Hand print names legibly; handwriting satisfactory for remainder.

Indices: Negative See below

Subject's name and aliases <i>U.S.S.B. TELEPHONIC THREAT AGAINST FIDEL CASTRO</i>	Character of case <i>Protection of Foreign Officials</i>
	Complainant <i>U.S. Secret Service 466-4400</i>
	Complaint received <input type="checkbox"/> Personal <input checked="" type="checkbox"/> Telephonic Date <i>10/8/79</i> Time <i>10²⁰ P</i>

Address of subject	Complainant's address and telephone number
--------------------	--

Subject's Description	Race	Sex <input type="checkbox"/> Male <input type="checkbox"/> Female	Height	Hair	Build	Birth date and Birthplace
	Age		Weight	Eyes	Complexion	Social Security Number
	Scars, marks or other data					

Facts of complaint

On 10/8/79, 10²⁰ P, [redacted] U.S. Secret Service notified writer that a nonspecific telephone call was received by the North Tarrytown P.D. (OFFICER [redacted]) at 9⁵⁵ P same date from an unknown caller stating an "assassin" from Miami will kill Castro every if they have to give up their own lives." telephone call was not tape recorded and no further info available. Caller is believed to be a Hispanic male in his twenties.

b6
b7C

Action Recommended <i>For info M-10</i>	<i>SA [redacted] M-9</i>	<i>North Tarrytown P.D.'s telephone # 914-631-0800</i>
--	--------------------------	--

b6
b7C

b6
b7C

060017 3621453

PP RC NK MF WM NY

DE CG

P 281450Z OCT 79

M CHICAGO [redacted] (SQUAD 12)

b3
b7E

TO DIRECTOR PRIORITY

NEWARK PRIORITY

WFO PRIORITY

MIAMI PRIORITY

ADIC, NEW YORK PRIORITY

BT

~~CONFIDENTIAL~~

ATTENTION DIVISION 6, TERRORIST SECTION

[redacted]

b3
b7E

THE FOLLOWING WAS PROVIDED ON OCTOBER 23, 1979, BY
A HIGHLY SENSITIVE SOURCE WHO HAS PROVIDED RELIABLE
INFORMATION IN THE PAST:

SOURCE ADVISED THAT [redacted]

[redacted]

b3
b6
b7C
b7D

original in

[redacted]

155-899-116

SEARCHED	[redacted]	[redacted]
SERIALIZED	[redacted]	[redacted]
OCT 29 1979		
[redacted]	[redacted]	

b3
b6
b7C
b7E

PAGE TWO

[REDACTED]

~~CONFIDENTIAL~~

[REDACTED]

b3
b6
b7C
b7D
b7E

[REDACTED]

~~(S)~~ (U)

THE FOLLOWING IS THE PERTINENT INFORMATION THAT

SOURCE OBTAINED

[REDACTED]

~~(S)~~ (U)

b3
b6
b7C
b7D

CAZVIZ:

[REDACTED]

ADVISED

[REDACTED]

[REDACTED]

b3
b6
b7C
b7D

-116

[REDACTED]

ACCORDING TO SOURCE,

[REDACTED]

Original in

[REDACTED]

[REDACTED]

b3
b6
b7C
b7E

[REDACTED]

[Redacted]

[Redacted]

b3
b6
b7C
b7D
b7E

[Redacted]

~~(S)~~ (U)

FOR INFORMATION OF MIAMI,

[Redacted]

[Redacted]

b3
b6
b7C
b7D

[Redacted]

~~(S)~~ (U)

ALSO FOR THE INFORMATION OF THE BUREAU AND MIAMI,

[Redacted]

b3
b6
b7C
b7D

[REDACTED]

b3
b6
b7C
b7D
b7E

[REDACTED]

~~(S)~~ (U)

~~C AND E 2080, REASON 2 AND 3, DRD OCTOBER 29, 1999.~~

ADMINISTRATIVE

CHICAGO SOURCE IS [REDACTED] WHOSE RELIABILITY HAS BEEN PROVEN IN THE PAST. EXTREME CAUTION SHOULD BE EXERCISED IN THE USE OF THE INFORMATION SET FORTH ABOVE, DUE TO THE HIGHLY SENSITIVE POSITION SOURCE IS PRESENTLY IN, AND ALSO DUE TO THE SINGULAR NATURE OF THE INFORMATION HE HAS OBTAINED. IT IS RECOMMENDED THAT THIS INFORMATION SHOULD NOT BE INCLUDED IN THE DETAILS OF A REPORT OR DISSEMINATED OUTSIDE THE BUREAU, UNLESS IT IS SUITABLY PARAPHRASED.

b3
b7D

THE BUREAU SHOULD NOTE THAT [REDACTED]

[REDACTED]

b3
b7D

[REDACTED]

[REDACTED]

b3
b6
b7C
b7D
b7E

CHICAGO IS ALSO OF THE STRONG OPINION THAT SOURCE, IF HANDLED ACCORDINGLY, WILL ALSO BE IN A POSITION TO PROVIDE

[REDACTED]

b3
b6
b7C
b7D

IN VIEW OF THE FACT THAT

[REDACTED]

[REDACTED]

b3
b6
b7C
b7D

[REDACTED] ALL FUTURE CONTACTS WITH SOURCE WILL BE CONDUCTED IN A SECURE LOCATION TO INSURE THAT SOURCE'S RELATIONSHIP WITH THE FBI WILL NOT BE JEOPARDIZED IN ANY WAY.

BT

FEDERAL BUREAU OF INVESTIGATION

Date of transcription 10/12/79

[redacted] was contacted by Special Agent (SA) [redacted] Federal Bureau of Investigation (FBI), Miami, who immediately advised [redacted] of his identity and of the inquiry into an allegation that he had made plans to assassinate FIDEL CASTRO of Cuba during his visit to New York City, New York.

b6
b7C

[redacted] agreed to be interviewed and voluntarily furnished the following information:

b6
b7C

He is employed as an [redacted] and attends the University of Miami, [redacted]

b6
b7C

[redacted]

He said he is completely amazed at the allegation that he had told someone that he had placed an individual on an airplane for New York City for the purpose of killing FIDEL CASTRO with either an M-1 or an M-16 rifle.

[redacted] said that he had discussed radical anti-Castro groups with [redacted], but he did not indicate that he planned to send someone to kill FIDEL CASTRO.

b6
b7C

[redacted] stated that the individual who made the allegation against him must have misinterpreted what he said in the discussion about militant anti-Castro groups.

He stated that he had no intention to assassinate FIDEL CASTRO nor does he know of any plot to kill him.

He said that he does not personally know any militant anti-Castro individuals and can talk about their activities only from what he reads in newspapers or magazines or learns from friends or relatives.

Investigation on 10/10/79 at [redacted] File # Miami 185-126 /19
by SA [redacted] Date dictated 10/11/79

b6
b7C

MM 185-126

[redacted] flatly denied that he told anyone that he planned to have someone or have any knowledge of a plot to kill FIDEL CASTRO during his proposed visit to New York City in the next few days.

b6
b7C

The following descriptive information is set forth from interview and observation:

b6
b7C

Name:
Race:
Sex:
Date of Birth:
Place of Birth:
Height:
Weight:
Eyes:
Hair:
Home Address:
Occupation:
Employment:

Education:

Other Training:

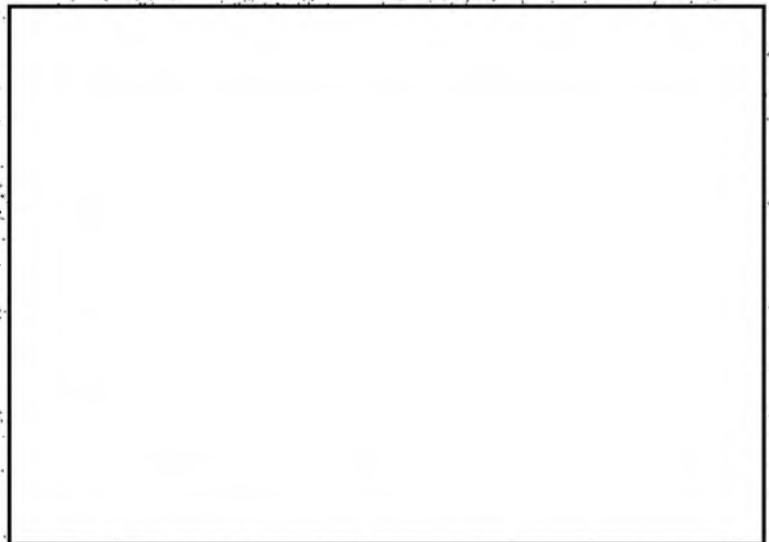

FBI

TRANSMIT VIA:

- Teletype
- Facsimile
- AIRTEL

PRECEDENCE:

- Immediate
- Priority
- Routine

CLASSIFICATION:

- TOP SECRET
- SECRET
- CONFIDENTIAL
- UNCLAS E F T O
- UNCLAS

Date 10/17/79

TO: ADIC, NEW YORK (185-899)
 FROM: SAC, MIAMI (185-126) (P)
 SUBJECT: CAZVIZ
 PFO
 (OO: NEW YORK)

Enclosed for New York are the original and one copy of FD-302 reflecting interview of [redacted] regarding an allegation that he had made plans to assassinate FIDEL CASTRO of Cuba during his visit to New York City, New York.

b6
b7c

② - New York (Encl)
 1 - Miami
 [redacted]
 (3)

b6
b7c

185-899-120
 SEARCHED [] INDEXED []
 SERIALIZED [] FILED []
 OCT 24 1979
 [redacted]

b6
b7c

Approved: [redacted]

Transmitted _____ (Number) _____ (Time)

Per _____

VIZIV

SJ0387 2881804Z

RR HI MM NY

DE SJ 0002

R 151735Z OCT 79

FM SAN JUAN [REDACTED]

b3
b7E

TO DIRECTOR [REDACTED] ROUTINE

ATTN: INTELLIGENCE DIVISION, CI-2 UNIT

MIAMI ROUTINE

NEW YORK ROUTINE

BT

~~SECRET~~

[REDACTED] (OO: SAN JUAN)

b3
b7E

REFERENCE SAN JUAN TELETYPES, OCTOBER 12, 1979 AND
OCTOBER 10, 1979, ENTITLED [REDACTED] CAZVIZ;
PFO", AND SAN JUAN TELEPHONE CALL TO BUREAU, OCTOBER 12,
1979.

THIS TELETYPE IS CLASSIFIED "~~SECRET~~" IN ITS ENTIRETY.

b3
b6
b7C
b7D

ON OCTOBER 13, 1979, [REDACTED] ADVISED AS FOLLOWS:

[REDACTED]

cc
to M-10

M-10

185- 899-125

SEARCHED [REDACTED] [REDACTED]

OCT 15 1979

b6
b7C

[REDACTED]

PAGE FIVE

[Redacted]

~~SECRET~~

b3
b7E

NEW YORK IS AGAIN REQUESTED TO DETERMINE THE SUBSCRIBER

TO

[Redacted]

ALSO, IF NEW YORK

[Redacted]

[Redacted]

NH

b3
b6
b7C
b7D
b7E

[Redacted]

b3
b6
b7C
b7D
b7E

~~C AND E, 8024, REASONS (2) AND (3), DRD OCTOBER 15, 1999.~~

BT

[Handwritten mark]

ADVISED they will need a form for this request.

b6
b7C

Complaint Form
FD-71 (Rev. 8-29-74)

NOTE: Hand print names legibly; handwriting satisfactory for remainder.

Indices: Negative See below

Subject's name and aliases
3 MALE UNSUBS:

Character of case
185-PFO

POSSIBLE ATTEMPT TO ASSASSINATE FIDEL CASTRO

Complainant
[Redacted]

b6
b7C
b7D

Complaint received
 Personal Telephonic Date **10/14/79** Time **1240 A.**

Address of subject
[Redacted]

Complainant's address and telephone number
[Redacted]

Subject's Description	Race	Sex <input type="checkbox"/> Male <input type="checkbox"/> Female	Height	Hair	Build	Birth date and Birthplace
	Age		Weight	Eyes	Complexion	Social Security Number
	Scars, marks or other data					

Facts of complaint
COMPLAINANT ADVISED NYO OF A MEETING TO TAKE PLACE THIS A.M. TO FORMULATE PLANS TO ASSASSINATE FIDEL CASTRO. [Redacted]

b6
b7C
b7D

SA [Redacted] - SA [Redacted] ADVISED - U.S.S. ADVISED - NYPD ADVISED
NYO INDICES CHECK RE: [Redacted] - NEGATIVE [Redacted]

b6
b7C
b7D

* NY TELEPHONE CO. CHECK SHOWED [Redacted] BUT DID NOT REVEAL - [Redacted]

SA [Redacted] ADVISED OF ALL ABOVE INFO.

b6
b7C

TAPE OF COMPLETE CONVERSATION ATTACHED.

Action Recommended
[Redacted] #16
(Agent)

185-899-127
SEARCHED [Redacted] INDEXED [Redacted]
SERIALIZED [Redacted] FILED [Redacted]
OCT 14 1979
FBI - NEW YORK

b6
b7C

Memorandum

TO : Supervisor [redacted] (11-10) DATE: 10/13/79

FROM : SA [redacted] (Weekend Supr)

SUBJECT: Cuban Mission to the United Nations
Protection of Foreign Officials

b6
b7C

At 6:30 PM, 10/13/79, [redacted], advisor, US State Department, attached to US Mission to the UN, reported that he had received a telephone call from US Ambassador to UN McHenry. McHenry reported that he had just gotten a phone call from the Cuban Ambassador to UN complaining that a group of "dissenting" Cubans had set up a loudspeaker about a block from the Mission and were broadcasting obscenities and other invectives against Castro.

b6
b7C

SA's [redacted] were dispatched to the scene - [redacted]

b6
b7C

185-899-128

SEARCHED	INDEXED
SERIALIZED	FILED
OCT 13 1979	
[redacted]	YO [redacted]



Complaint Form
FD-71 (Rev. 8-29-74)

NOTE: Hand print names legibly; handwriting satisfactory for remainder.

Indices: Negative See below

Subject's name and aliases

CAZVIZ

Character of case

PFO

Complainant

[Redacted]

Complaint received

Personal

Telephonic

Date 10/12/79

Time 11:50 AM

Address of subject

Complainant's address and telephone number

Subject's Description

Race

Sex

Height

Hair

Build

Birth date and Birthplace

Age

Male

Weight

Eyes

Complexion

Social Security Number

Female

Scars, marks or other data

Facts of complaint

Action Recommended

SA

(Agent)

M-10

SEARCHED

INDEXED

SERIALIZED

FILED

OCT 12 1979

FBI - NEW YORK

185-8997-179

b6
b7C
b7E

b6
b7C
b7E

b6
b7C

Complaint Form
FD-71 (Rev. 8-29-74)

NOTE: Hand print names legibly; handwriting satisfactory for remainder.

Indices: Negative See below

Subject's name and aliases
*UNSUB; THREAT TO BOMB
CUBAN MISSION TO U.N.*

Character of case
EID; PFO

Complainant
[Redacted]

Complaint received
 Personal Telephonic Date *10/2/79* Time *10:33 PM*

Address of subject

Complainant's address and telephone number
FBI, Newark.

Subject's Description	Race	Sex <input type="checkbox"/> Male <input type="checkbox"/> Female	Height	Hair	Build	Birth date and Birthplace
	Age		Weight	Eyes	Complexion	Social Security Number
Scars, marks or other data						

Facts of complaint

[Redacted] stated that at 10:30 PM this date anonymous male called FBI Newark and stated, "There's a bomb in the Cuban Mission".
 There's a bomb in the Cuban Mission".
 [Redacted] asked what time the bomb was going to go off and caller stated, "I'm not going to say any more."
 SA [Redacted] USSS, advised,

Action Recommended [Redacted] (Agent) *17/16*

185-899-130
 SEARCHED [Redacted] INDEXED [Redacted]
 SERIALIZED [Redacted]
 -10 OCT 12 1979
 FBI - NEW YORK [Redacted]

b6
b7C

b6
b7C

b6
b7C

b6
b7C

Complaint Form
FD-71 (Rev. 8-29-74)

NOTE: Hand print names legibly; handwriting satisfactory for remainder.

Indices: Negative See below

Subject's name and aliases UNSUBS; Threat AGAINST CASTRO. 10-11-79	Character of case PFO
	Complainant Det. [redacted]
	Complaint received <input type="checkbox"/> Personal <input checked="" type="checkbox"/> Telephonic Date 10-11-79 Time 1:50 AM

b6
b7C

Address of subject	Complainant's address and telephone number NY PD INTELLIGENCE [redacted]
--------------------	--

Subject's Description	Race	Sex <input type="checkbox"/> Male <input type="checkbox"/> Female	Height	Hair	Build	Birth date and Birthplace
	Age		Weight	Eyes	Complexion	Social Security Number
	Scars, marks or other data					

Facts of complaint

COMPLAINANT STATED THAT THE POLICE OPERATIONS UNIT ADVISED OF A 911 OPERATOR RECEIVING A CALL FROM AN ANONYMOUS MALE AT 10:50 PM. CALLER STATED THAT HE OVERHEARD MALES IN A CHECKER CAB SAYING THEY HAD MACHINE GUNS AND SHOTGUNS AND WERE GOING TO KILL CASTRO. CALLER SAID THAT THE LETTERS "IL" WERE ON THE TOP OF THE CAB.

185-899-132

USSS ADVISED THAT THEY HAD ALREADY RECEIVED THIS INFO. 1:55 AM

SEARCHED [] INDEXED []
SERIALIZED [] FILED []
M-10 OCT 11 1979
[] EW YORK []

b6
b7C

Action Recommended [redacted] #16
[redacted] (Agent)

NOTE: Hand print names legibly; handwriting satisfactory for remainder.

Indices: Negative See below

Subject's name and aliases CAZVIZ ; INFO CONCERNING POSSIBLE SECURITY THREAT. 10-11-79.	Character of case PFO
	Complainant DET. [REDACTED]
	Complaint received <input type="checkbox"/> Personal <input checked="" type="checkbox"/> Telephonic Date 10-11-79 Time 12:05AM

b6
b7C

Address of subject	Complainant's address and telephone number POLICE INTELLIGENCE DIV. [REDACTED] 185-899-133
--------------------	--

Subject's Description	Race	Sex <input type="checkbox"/> Male <input type="checkbox"/> Female	Height	Hair	Build	Birth-date and Birthplace
	Age		Weight	Eyes	Complexion	SEARCHED [initials] INDEXED [initials] SERIALIZED [initials] FILED [initials] Social Security Number
	Scars, marks or other data					

OCT 11 1979
FBI-NEW YORK [REDACTED]

b6
b7C

Facts of complaint
COMPLAINANT ADVISED THAT POLICE INTELLIGENCE DIV.
RECEIVED INFORMATION FROM [REDACTED]

[REDACTED]

b6
b7C
b7D
b7E

COMPLAINANT ADVISED THAT THIS INFORMATION CAME FROM A [REDACTED]
[REDACTED] SOURCE BUT HAD NO FURTHER DETAILS.

[REDACTED]

b6
b7C
b7D
b7E

[REDACTED] FURTHER ADVISED THAT THEY HAD FURTHER
DETAILS CONCERNING THIS SITUATION AND THEY WERE INVESTIGATING TO
DETERMINE WHEREABOUTS OF THESE INDIVIDUALS. DETAILS ARE TO BE

Action Recommended [REDACTED]
[REDACTED] #10
(Agent)

b6
b7C

Complaint Form
FD-21 (Rev. 3-29-74)

NOTE: Hand print names legibly; handwriting satisfactory for remainder.

Indices: Negative See below

Subject's name and aliases <i>CAZVIZ</i>	Character of case
	Complainant
	Complaint received <input type="checkbox"/> Personal <input type="checkbox"/> Telephonic Date _____ Time _____

Address of subject	Complainant's address and telephone number
--------------------	--

Subject's Description	Race	Sex <input type="checkbox"/> Male <input type="checkbox"/> Female	Height	Hair	Build	Birth date and Birthplace
	Age		Weight	Eyes	Complexion	Social Security Number
	Scars, marks or other data					

Facts of complaint
FORWARDED TO NYO VIA TELETYPE LATER THIS DATE.
COMPLAINANT ADVISED THAT

b7E

Action Recommended	
	
	(Agent) _____

b6
b7C

Complaint Form
FD-71 (Rev. 8-29-74)

NOTE: Hand print names legibly; handwriting satisfactory for remainder.

Indices: Negative See below

Subject's name and aliases [Redacted] aka FIDEL CASTRO - VICTIM.		Character of case PFO
Complainant P.O. [Redacted] NYCPD Intell.		Complaint received <input type="checkbox"/> Personal <input checked="" type="checkbox"/> Telephonic Date 10/11/79 Time 8:05 P

b6
b7C

Address of subject	Complainant's address and telephone number
--------------------	--

Subject's Description	Race HISPANIC	Sex <input checked="" type="checkbox"/> Male <input type="checkbox"/> Female	Height	Hair	Build	Birth date and Birthplace
	Age	Weight	Eyes	Complexion	Social Security Number	
	Scars, marks or other data					

Facts of complaint

C. advised that subject called 911 operator [Redacted] position 83 at 1907 hrs. who stated the following:

"20 minutes from when Castro is at the U. N., I will shoot him, I am bringing 20 Mexicans and 150 other people."

Operator advised intell that caller was obviously drunk.

USSS [Redacted] advised.

b6
b7C

b6
b7C

[Redacted]	[Redacted]	[Redacted]
Action Recommended	[Redacted]	#16.
(Agent)		

b6
b7C

185-899-134

SEARCHED [Redacted] INDEXED [Redacted]
SERIALIZED [Redacted] FILED [Redacted]
OCT 1 1979
NEW YORK

NOTE: Hand print names legibly; handwriting satisfactory for remainder.

Indices: Negative See below

Subject's name and aliases <i>UNSUB;</i>		Character of case <i>PFO</i>	
<i>THREAT TO ASSASSINATE FIDEL CASTRO AT N.Y.C, N.Y</i>		Complainant <i>P.O.</i> [redacted] <i>nycto intell.</i>	
		Complaint received <input type="checkbox"/> Personal <input checked="" type="checkbox"/> Telephonic Date <i>10/11/79</i> Time <i>8:05 P</i>	
Address of subject <i>10/11/79</i>		Complainant's address and telephone number	

b6
b7C

Subject's Description	Race <i>W</i>	Sex <input checked="" type="checkbox"/> Male <input type="checkbox"/> Female	Height	Hair	Build	Birth date and Birthplace
	Age		Weight	Eyes	Complexion	Social Security Number
	Scars, marks or other data					

Facts of complaint
C. advised that [redacted] ABC News, N.Y.C. received an anonymous telephone call at 1910 hrs from a white male, sober, serious who stated the following: "If Fidel Castro is not out of town by midnight, the whole East Side will blow up"

b6
b7C

USSS [redacted] advised.

b6
b7C

[redacted]

185-899-135

SEARCHED [] INDEXED []
 SERIALIZED [] FILED []
 OCT 1 1979
 YORK

b6
b7C

Action Recommended [redacted] # *16*
 (Agent)

NOTE: Hand print names legibly; handwriting satisfactory for remainder.

Indices: Negative See below

Subject's name and aliases
*UNSUB; THREAT TO
BOMB CUBAN MISSION
TO UN*

Character of case
EID i PFO

Complainant
SA [Redacted]

Complaint received
 Personal Telephonic Date *10/11/79* Time *11:55 PM*

Address of subject

Complainant's address and telephone number
*USSS
466 - 4400*

Subject's Description	Race	Sex <input type="checkbox"/> Male <input type="checkbox"/> Female	Height	Hair	Build	Birth date and Birthplace
	Age		Weight	Eyes	Complexion	Social Security Number

Scars, marks or other data

Facts of complaint

Complainant stated that at 2347 hours, NYCPD Operator 911 received call from unknown male who stated, "A bomb will go off at the Cuban Mission at P.A.M."

[Redacted]

185-899-136
SEARCHED [] INDEXED []
SERIALIZED [] FILED []
OCT 17 1979
FBI - NEW YORK

Action Recommended

[Redacted] *(#16)*

b6
b7C

b6
b7C

NOTE: Hand print names legibly; handwriting satisfactory for remainder.
Indices: Negative See below

Subject's name and aliases
*UNSUB;
THREAT TO KILL
FIDEL CASTRO AT 320
LEXINGTON AVE, N.Y., N.Y.
10/10/79*

Character of case
PFO

Complainant
DET. [redacted] INTELL. DIV.

Complaint received
 Personal Telephonic Date *10/10/79* Time *8:10 p*

b6
b7C

Address of subject

Complainant's address and telephone number

Subject's Description	Race	Sex <input type="checkbox"/> Male <input type="checkbox"/> Female	Height	Hair	Build	Birth date and Birthplace
	Age		Weight	Eyes	Complexion	Social Security Number
	Scars, marks or other data					

Facts of complaint
C. advised that he is temporarily assigned from A+E to Intell. Div., and was advised that Capt [redacted] Commanding Officer of Mounted Unit at Madison Square Garden, was approached by the president of the current horse show held at the Garden who stated that he overheard two unsubs stating that they ^{will} "rent two trucks, put something in it, head for 320 Lexington Ave. to get Castro."

b6
b7C

USSS [redacted] advised

185-899-137

b6
b7C

Action Recommended
[redacted] *16.*
(Agent)

M10
[redacted]
[redacted]

Complaint Form
FD-71 (Rev. 8-29-74)

NOTE: Hand print names legibly; handwriting satisfactory for remainder.

Indices: Negative See below

Subject's name and aliases
[redacted] threat
against pro-Castro individuals
10-8-79.

Character of case
Info

Complainant
[redacted]

Complaint received
 Personal Telephonic Date 10-8-79 Time 11:40 PM

Address of subject

Complainant's address and telephone number
[redacted]

Subject's Description	Race	Sex <input type="checkbox"/> Male <input type="checkbox"/> Female	Height	Hair	Build	Birth date and Birthplace
	Age		Weight	Eyes	Complexion	Social Security Number
	Scars, marks or other data					

Facts of complaint

Complainant identified himself as [redacted] of [redacted] and stated that "I'm going to that rolley and if I see any Pro-Castro's, I'm going to break their motherfucking heads." Complainant hung up before any questions could be asked. Complainant was breathing heavy + sounded upset.

185-899-138

[redacted]

M-10 OCT 08 1979

[redacted]

Action Recommended
For info.
[redacted]
(Agent)

b6
b7C

b6
b7C

b6
b7C

Complaint Form
FD-71 (Rev. 8-29-74)

NOTE: Hand print names legibly; handwriting satisfactory for remainder.

Indices: Negative See below

Subject's name and aliases

(FNU) [redacted] (PH)

Character of case

Complainant

Complaint received

Personal Telephonic Date 10/6/79 Time 740p

Address of subject

Complainant's address and telephone number

Subject's Description	Race	Sex	Height	Hair	Build	Birth date and Birthplace
	Age	<input type="checkbox"/> Male <input type="checkbox"/> Female	Weight	Eyes	Complexion	Social Security Number
	Scars, marks or other data					

Facts of complaint

AT 7:40 PM 10/6/79 [redacted] CONTACTED THE NYO AND ADVISED THAT [redacted]

[Large redacted area]

AT 750 AM SUPAN [redacted] WAS ADVISED OF THE ABOVE AND ADVISED NYO CONTACT SA [redacted] THIS WAS DONE AT 755 AM AND AFTER BEING INFORMED OF THE ABOVE STATED THAT HE WOULD MAINTAIN CONTACT WITH NYO FOR ANY FURTHER [redacted]

Action Recommended

SM

M-10

SEARCHED INDEXED
SERIALIZED FILED
OCT 06 1979
FBI NEW YORK

b6
b7C
b7E

b7E

b6
b7C
b7E

b6
b7C
b7E

b6
b7C

b6
b7C

COMMUNIST FRONT
PPAG
DE WIS

230211Z SEPT 79

FM MIAMI [redacted] (P)

b3
b7E

TO DIRECTOR PRIORITY

NEW YORK PRIORITY

SAN FRANCISCO PRIORITY

SAN JUAN VIA WASHINGTON PRIORITY

BT

~~SECRET~~

ATTENTION: BUREAU - INTD.

[redacted] BUREAU FILE [redacted]

b3
b6
b7C
b7E

[redacted]

[redacted] EID; [redacted]

PROPOSED VISIT OF CUBAN PREMIER FIDEL CASTRO TO THE UNITED STATES OCTOBER, 1979; PFO MATTER.

THIS COMMUNICATION IS CLASSIFIED ~~SECRET~~ IN ITS ENTIRETY.

ON SEPTEMBER 23, 1979, AN OPERATIONAL ASSET WHO HAS FURNISHED RELIABLE INFORMATION IN THE PAST ADVISED AS FOLLOWS:

b3
b6
b7C
b7D

[redacted]

white copy

[redacted]

185-899-141

SEARCHED
SERIALIZED

[redacted]

[redacted]

b6
b7C

SEP 28 1979

NEW YORK

[redacted]

[redacted]

[REDACTED]

[REDACTED]

b3
b6
b7C
b7D
b7E

~~CARD E BY 6234, REASONS (2) AND (3), DTD SEPTEMBER 28,~~

1979.

ADMINISTRATIVE:

~~RE MIAMI TELETYPE TO THE BUREAU SEPTEMBER 27, 1979.~~

~~OPERATIONAL ASSET IS~~

[REDACTED]

b3
b6
b7C
b7D

[REDACTED]

ASSET ALSO FURNISHED

[REDACTED]

b3
b7D

[REDACTED]

in file 1979 44

105-1000

PAGE FOUR (U)

[REDACTED]

~~SECRET~~

[REDACTED]

b3
b6
b7C
b7D
b7E

MIAMI WILL COVER ARRIVAL OF [REDACTED] AT MIAMI
INTERNATIONAL AIRPORT AND ATTEMPT TO OBTAIN PHOTOGRAPHS.

NEW YORK ATTEMPT TO OBTAIN ADDRESS FOR [REDACTED]
[REDACTED]

~~TO AND BY 6034, REASONS (2) AND (3), DHD SEPTEMBER 28,~~

1995.
BT

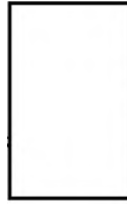

185-899-148

S. 100
S. 100

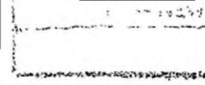
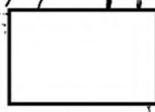

1

1

b6
b7C