

Date: 03/14/05

JFK ASSASSINATION SYSTEM
IDENTIFICATION FORM

AGENCY INFORMATION

AGENCY : CIA
RECORD NUMBER : 104-10335-10000
RECORD SERIES : JFK
AGENCY FILE NUMBER : PROJFILES-ARRB REQUESTS

Released under the John
F. Kennedy
Assassination Records
Collection Act of 1992
(44 USC 2107 Note).
Case#:NW 53217 Date:
06-24-2017

DOCUMENT INFORMATION

AGENCY ORIGINATOR : CIA
FROM :
TO :
TITLE : ARRB REQUEST - CIA-1: INFORMATION ON THE ORGANIZATION
OF CIA
DATE : 03/22/1995
PAGES : 64

SUBJECTS : JFK ASSASSINATION
UNIT INDEX
ARRB REQUEST

DOCUMENT TYPE : PAPER
CLASSIFICATION : SECRET
RESTRICTIONS : 1A 1B
CURRENT STATUS : RELEASED IN PART PUBLIC - RELEASED WITH DELETIONS
DATE OF LAST REVIEW : 05/06/03
COMMENTS : JFK-M-19 : F1 : 2000.02.15.15:55:10:750044 : UNIT INDEX

[R] - ITEM IS RESTRICTED 104-10335-10000

Assassination Records Review Board

600 E Street NW □ 2nd Floor □ Washington, DC 20530

March 22, 1995

Mr. John Pereira
Director
Historical Review Group
Center for the Study of Intelligence
Central Intelligence Agency
Washington, D.C. 20505

CIA HAS NO OBJECTION TO
DECLASSIFICATION AND/OR
RELEASE OF CIA INFORMATION
IN THIS DOCUMENT

RE: ARRB Additional Information Request No. CIA-1

Dear John:

I would like to thank you and your staff for your assistance and cooperation during our start-up phase. I trust that this bodes well for our work together during the upcoming years.

In order to facilitate and coordinate our efforts, I will be sending to you, from time-to-time, requests for additional information and records to facilitate the completion of the ARRB's responsibilities under the JFK Act. We will be numbering these requests, as shown above, to help us track our queries and your responses. Please do not hesitate to contact me or Jeremy Gunn if our requests are insufficiently clear or if they are unduly burdensome.

For our first request, we ask that you make available the following items:

- (a) Comprehensive organizational charts (or the best available substitutes) of the following entities for the years 1958-1968:¹

First, the Directorate of Plans (DDP or DD/P) *including*:

- Western Hemisphere Division (DDP/WH)
- Special Affairs Staff (DDP/SAS)
- Task Force W

¹We are of course aware that the names, organizational structure, and reporting relationships of the entities identified below have changed over time. We have listed some divisions, offices, and staffs in order to facilitate the identification of organizational charts. If the Agency refers or referred to these entities by any other names or acronyms, we would of course intend our request to include those other names or acronyms.

Telephone: (202) 724-0088 □ Facsimile: (202) 724-0457

Mr. John Pereira
March 22, 1995
Page 2

- Special Task Force Operations
- Counterintelligence Staff (DDP/CI)
- Soviet Russia Division (DDP/SR)
- Foreign Intelligence Staff (DDP/FI)
- Technical Services Division (DDP/TSD)
- Records Integration Division (DDP/RID)
- Division D
- Western Europe Division (WE);

Second, the Directorate of Support (DDS or DD/S) *including*:

- Office of Security (DDS/OS) (*including* Security Research Section);

Third, the Directorate of Intelligence (DDI or DD/I) *including*:

- National Photographic Interpretation Center (DDI/NPIC)
- Office of Operations (DDI/OO)
- Domestic Contacts Division *including* all DCD bases in Louisiana, Florida, and Texas;

Fourth, the Directorate of Research (DDR or DD/R) *including*:

- Special Projects Branch
- Technical Services Division;

Fifth, CIA stations in

- Mexico City (1960-68 only)
- Miami (JMWAVE)
- other stations that we will discuss orally;

Sixth, the Inspector General;

Seventh, the Office of the General Counsel;

Eighth, to the extent not otherwise included above, any entities with responsibility for liaison or communications with the Federal Bureau of Investigation on matters pertaining to intelligence or counterintelligence,² and

Ninth, any other offices, task forces, units, programs, persons, or other

²If there were persons (rather than entities) tasked with the responsibility for such liaisons with the FBI, please identify those individuals.

entities with any responsibilities for surveilling, conducting operations with respect to, or engaging in liaison with any pro-Castro groups (e.g., Fair Play for Cuba Committee) or anti-Castro groups (e.g., Alpha-66, DRE, JURE, etc.).

- (b) The names and affiliations of all CIA personnel responsible for liaison with the Warren Commission, the House Select Committee on Assassinations, the House Select Committee on Intelligence of the 94th Congress (the "Pike Committee"); the Senate Select Committee to Study Governmental Operations with Respect to Intelligence Activities (the "Church Committee"), and the Commission on CIA Activities within the United States (the "Rockefeller Commission").
- (c) All manuals, handbooks, memoranda, or guides explaining:
 - (i) the organizational structure and division of responsibilities within CIA for the years 1958-68 and 1975-79;
 - (ii) the filing systems or filing procedures for the entities identified in (a) above; and
 - (iii) guidelines for drafting memoranda or completing forms.

Examples of the type of documents we are seeking include the *Clandestine Services Instruction (CSI)*, the *Clandestine Services Handbook (CSHB)*, and the *Directorate of Operations Handbook (DOHB)*.

- (d) Copies of the instructions, guidelines, and other materials used by your reviewers in the review process. Barry Harrelson has already provided some – if not all – of these materials to Jeremy Gunn.
- (e) A list or lists of cryptonyms, digraphs, codes, pseudonyms, numericals, file identifications, or other identifications appearing in the assassination records (to the extent that such a list or lists have been or could readily be created).

To the extent that these materials are security classified, we will take all necessary precautions to protect them.

Mr. John Pereira
March 22, 1995
Page 4

I would like to thank you again for your cooperation. Please do not hesitate to contact me or Jeremy Gunn for any clarification regarding these requests.

Sincerely yours,

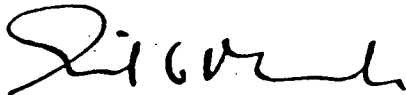

David G. Marwell
Executive Director

cc: Barry Harrelson
T. Jeremy Gunn
File 4.20.4-1

CIA SPECIAL COLLECTIONS
RELEASE IN FULL

Notes for April 7 meeting with ~~ARRB~~²⁰⁰⁰ Marwell, etc.)

Subject: ARRB Additional Information Request No. CIA-1

Item (a): "comprehensive organization charts...1958-68"

- Purpose? why 10 year time frame?
Many may not exist; DO traditional have published only sparse org charts.
- J. Gunn had ask for one on an early visit; found some information in JFK file; probably other, since HSCA ask for similar information

Item (a) Fifth: "CIA Stations"

- Why 10 years for Mex station; will find in file organization at time of assassination (requested by HSCA)
- What other stations and why?

Item (a) Ninth: [everything re Cuba]

- familiar with August release of material from Microfilm? [objective to release as much on anti-Cuba activities as possible during 1960-63 time frame plus any documents on Garrison investigation and plots against Castro.]
- Recommend review of Microfilm material before proceeding with this request

Item (c) "all manuals, [etc.]"

- many may not exist; when they do exist, access is usually restricted to use within that Agency component
- purpose? not need for review of our collection

Item (e) "...lists of cryptonyms, [etc.]"

- list of crypts with true names must remain in Agency building; access to information needed for reviewing collection will be provided but depending on sensitivity of source may be limited to specific individual(s)

Other issues:

Control/Review of notes taken during review

Control of "classified" documents taken out of building by ARRB

Question during review/channel

HRG guidelines

*Passed to Jim Pereira
on 5/19/95*

NOTE FOR: Jack Wright @ DA
FROM: Eldon I. Hatch
DATE: 05/15/95 04:15:47 PM
SUBJECT: JFK Assassination Board Requests

1. In response to subject requests for comprehensive organizational charts of the Directorate of Support and the Office of Security the following are provided:

TAB A - Directorate of Support Organizational Charts dated:

17 February 1956
8 February 1960
26 July 1962
27 September 1976

TAB B - Office of Security Organizational Charts dated:

17 February 1956
14 March 1958
1 April 1961
19 March 1962
26 July 1962
16 March 1963
3 November 1966

2. If there are any questions or further requests, please call me on 30683.

Eldon I. Hatch

CC:

~~SECRET~~

REGULATION
NO. 1-140

R 1-140
ORGANIZATION
17 February 1956

OFFICE OF THE DEPUTY DIRECTOR (SUPPORT)

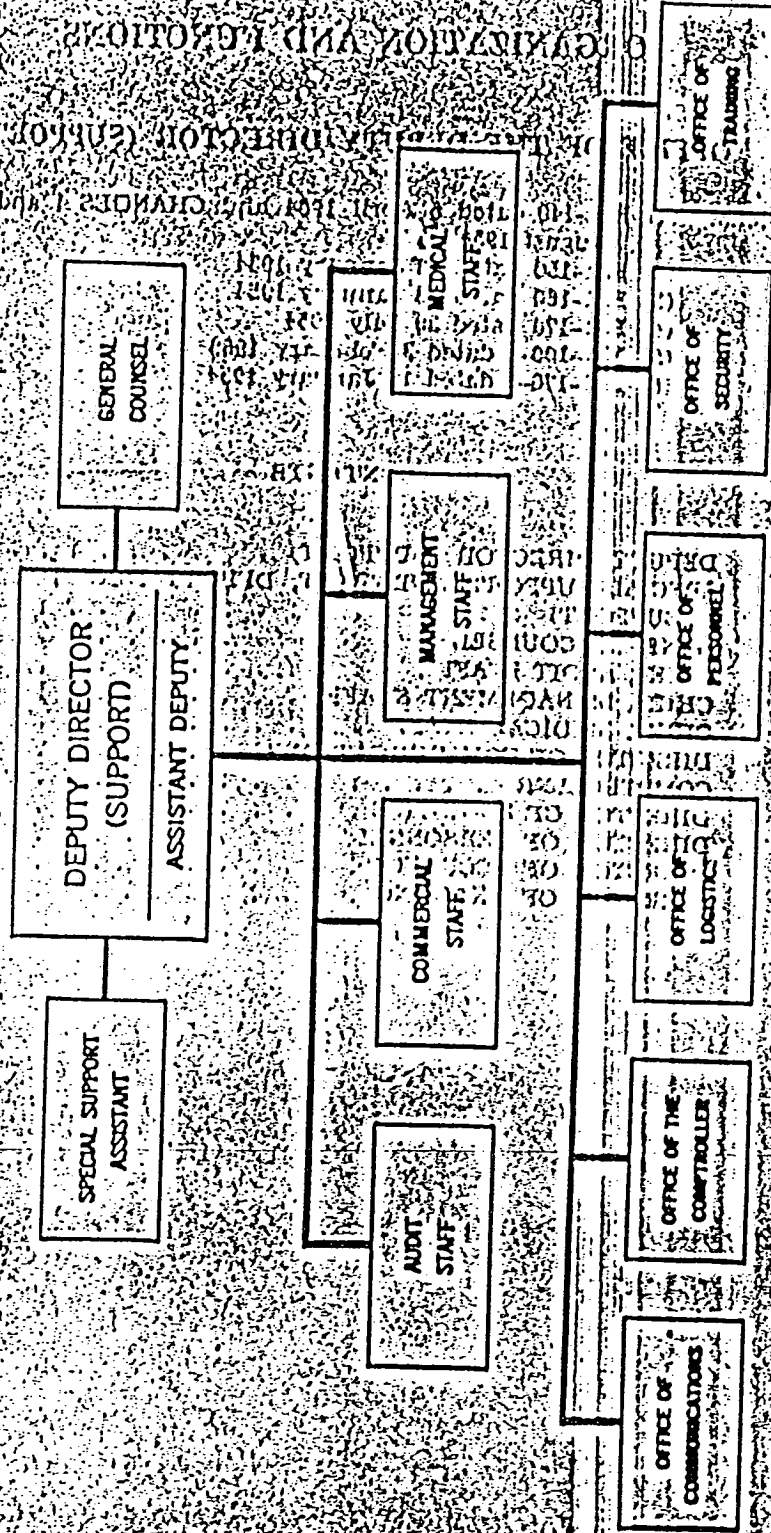

Figure 1

ILLIUS 2-56

~~SECRET~~

~~SECRET~~

R 1-140
ORGANIZATION
Revised 8 February 1960

REGULATION
NO. 1-140

OFFICE OF THE DEPUTY DIRECTOR (SUPPORT)

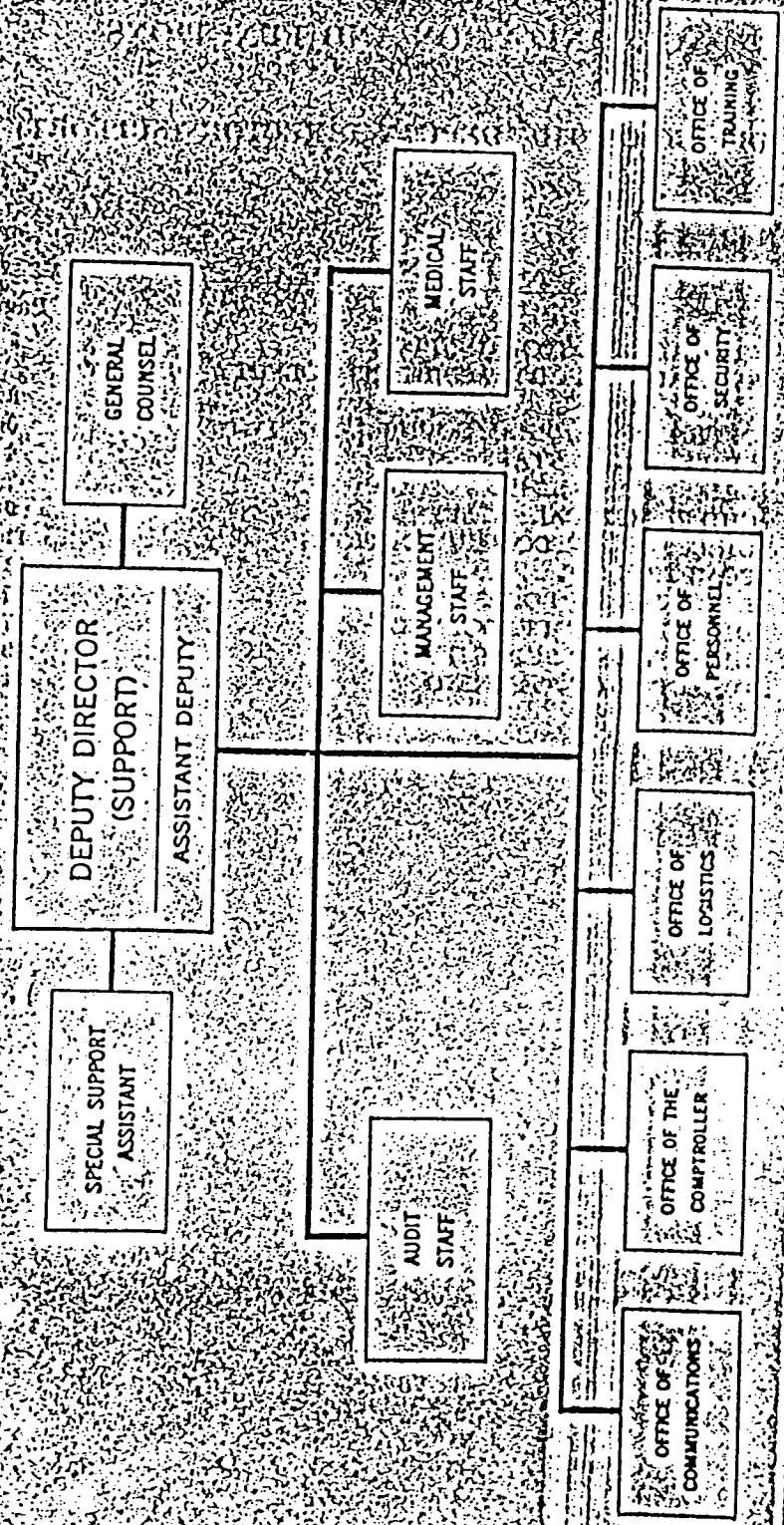

Figure 1

2

28661 2-60

~~SECRET~~

HR 1, fig. 17

ORGANIZATION

DIRECTORATE OF ADMINISTRATION

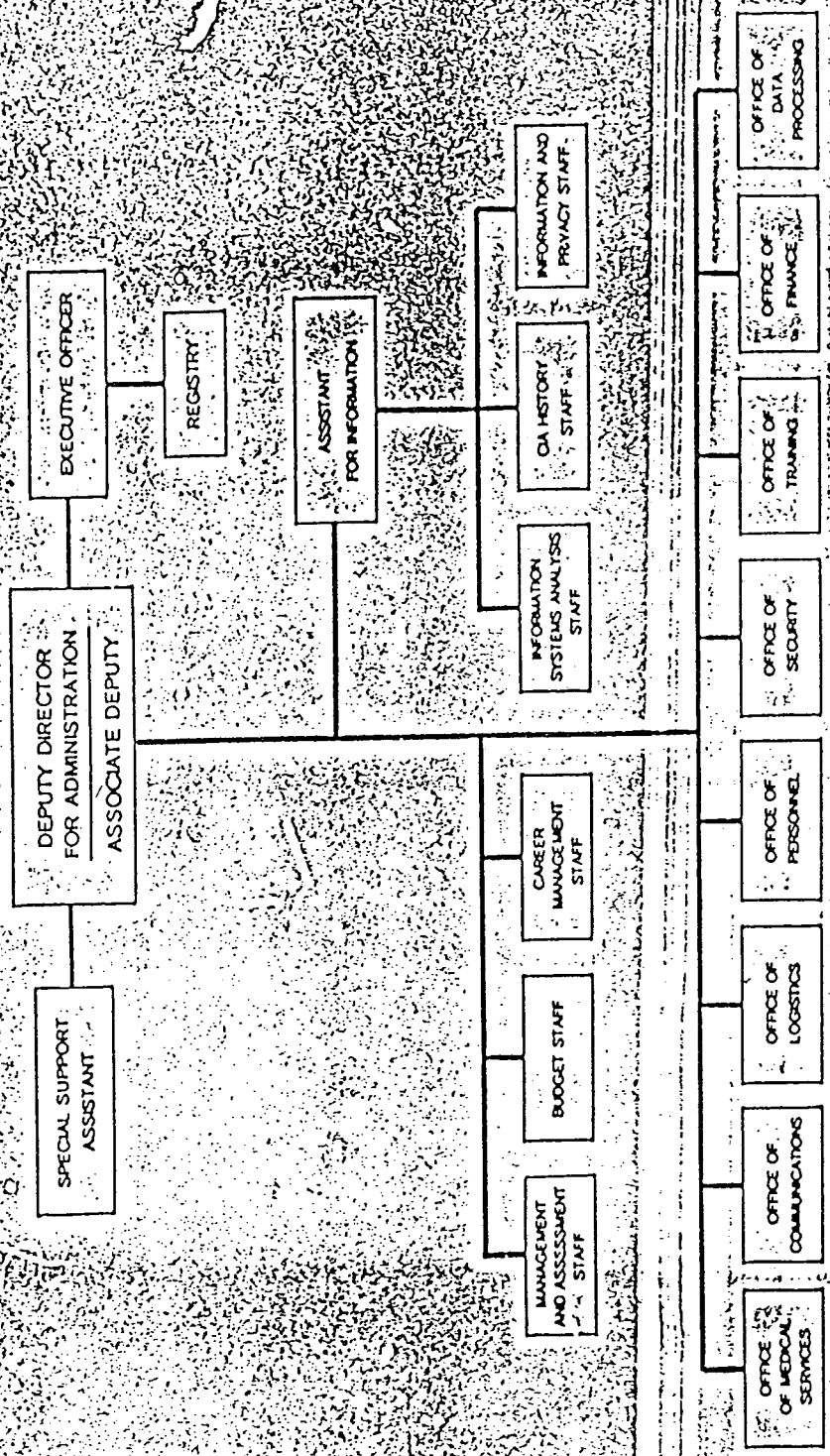

~~SECRET~~

OFFICE OF SECURITY

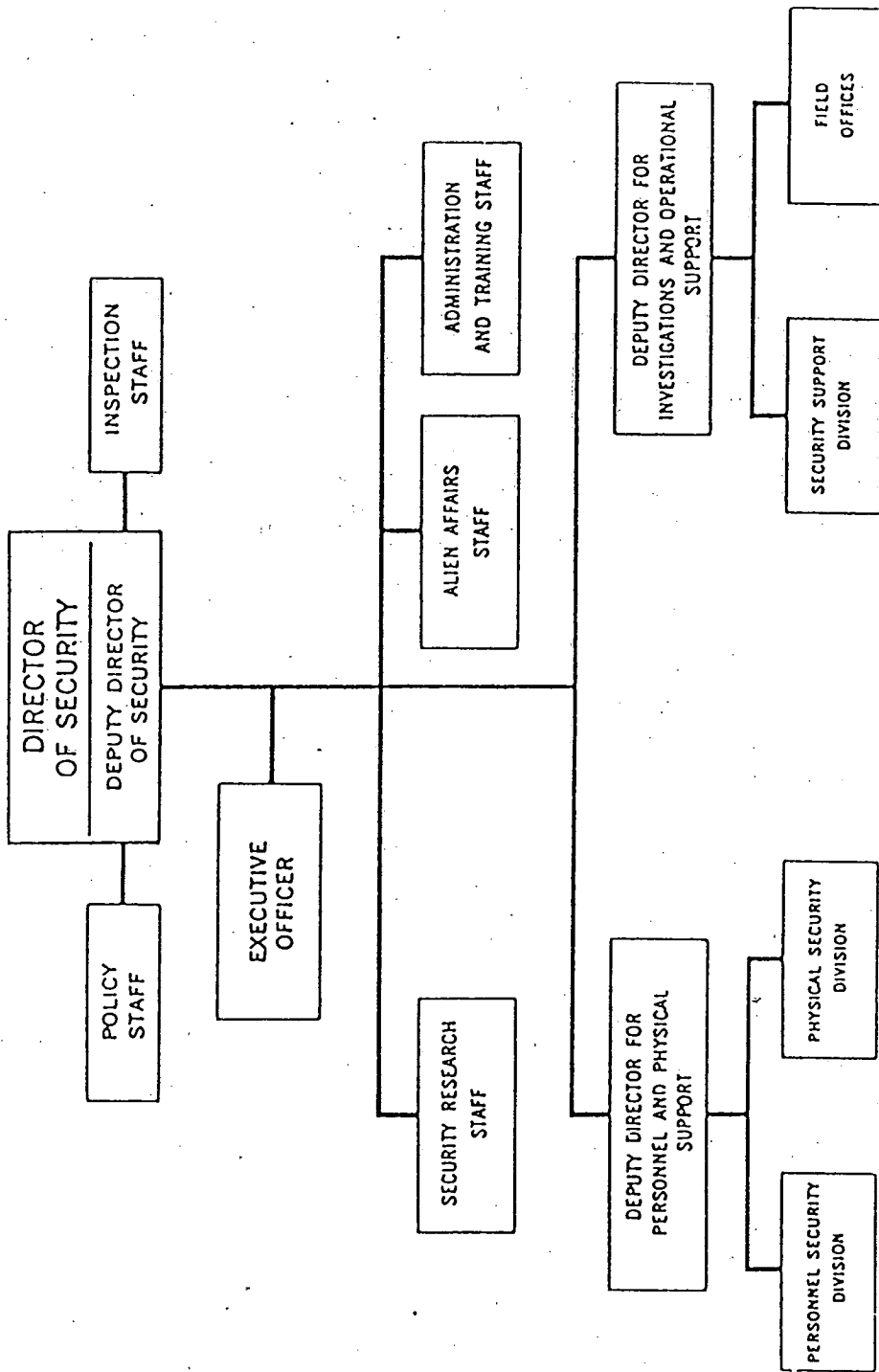

Figure 8

~~SECRET~~

OFFICE OF SECURITY

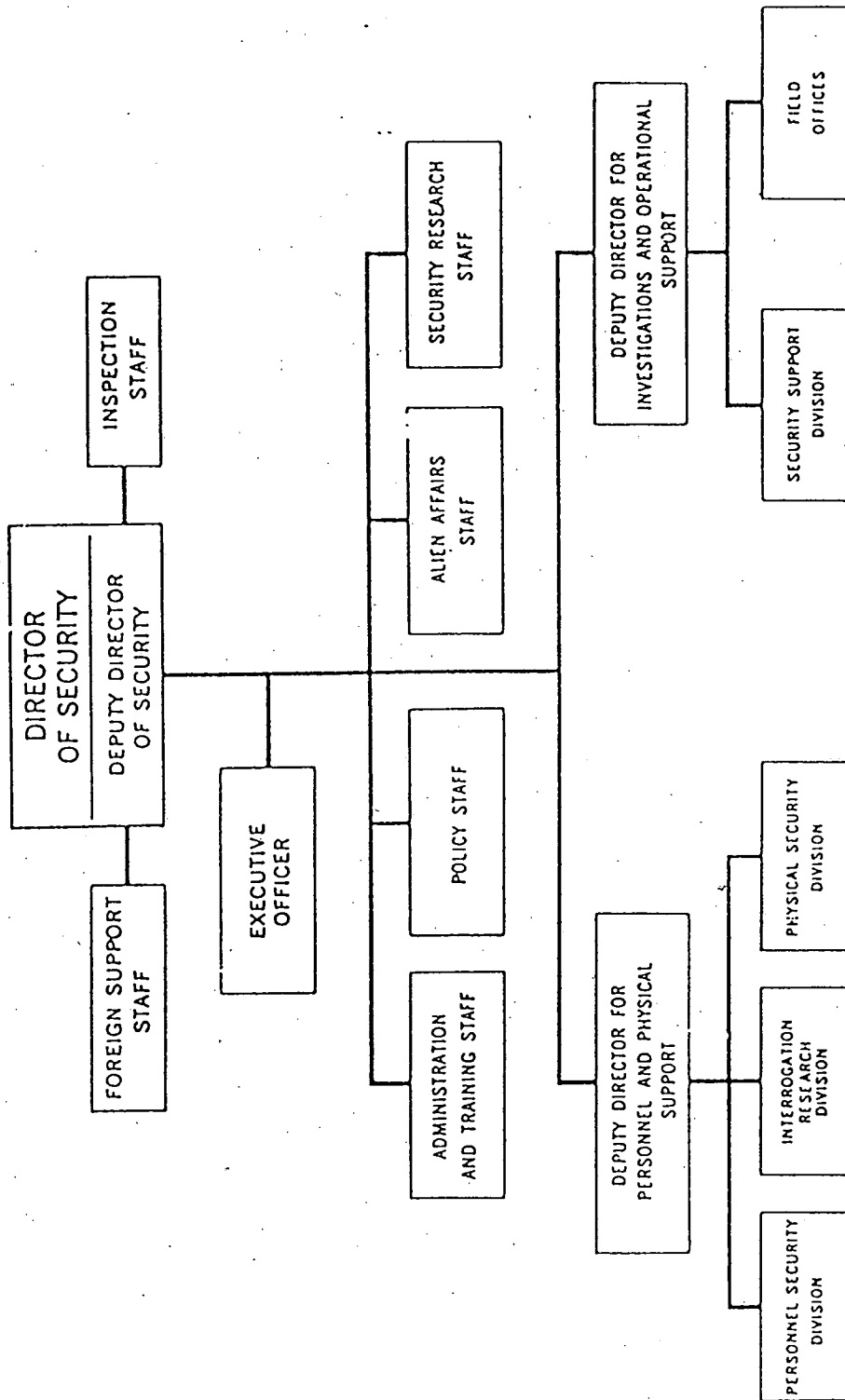

Figure 8

HR 1, fig. 18

ORGANIZATION

*HR 1, Fig 18 (Dist # 59)
19 March 1962*

OFFICE OF SECURITY

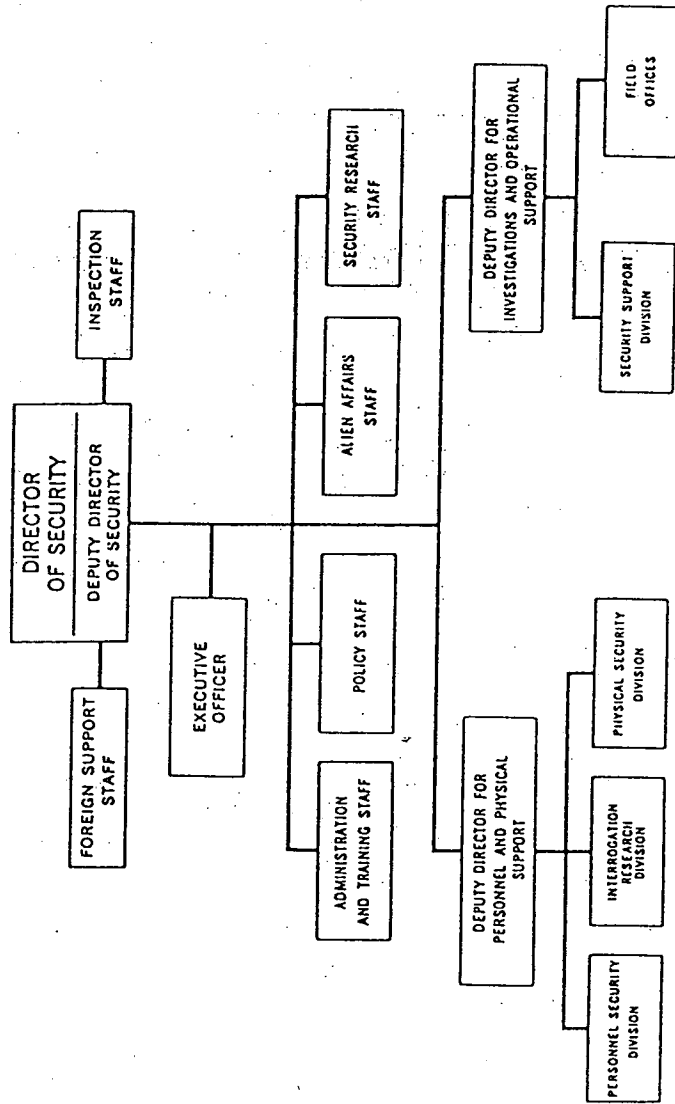

HR 1, fig. 18

HR 1 (Part 5 #93)
26 July 1962

ORGANIZATION

OFFICE OF SECURITY

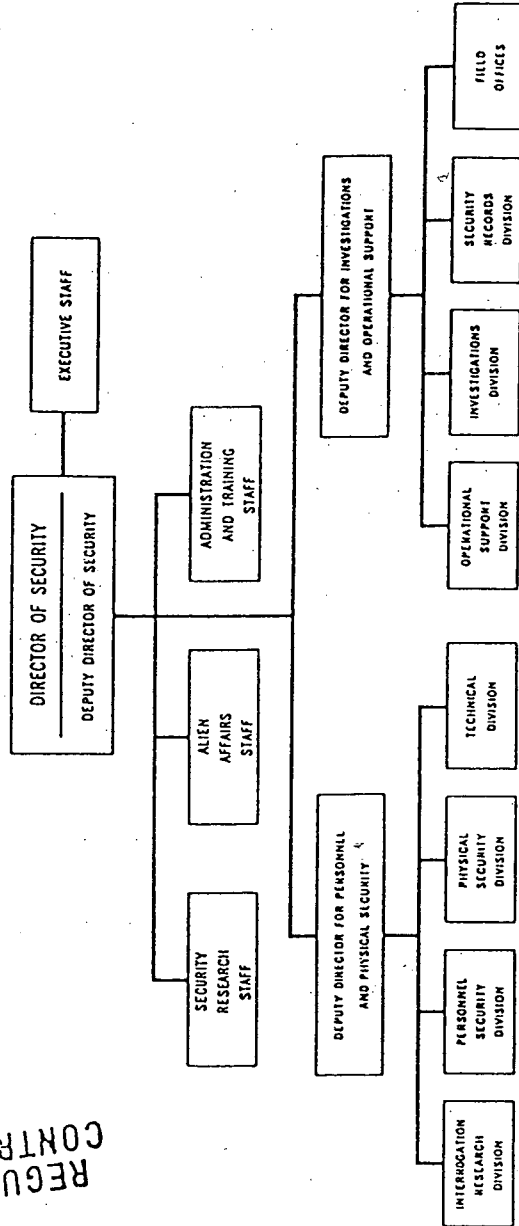

REGULATIONS CONTROL STAFF

APR 13 10 16 AM '62

HR 1, fig. 18

~~SECRET~~

HR (PARTS #1-11) ORGANIZATION
16 Aug. 63

OFFICE OF SECURITY

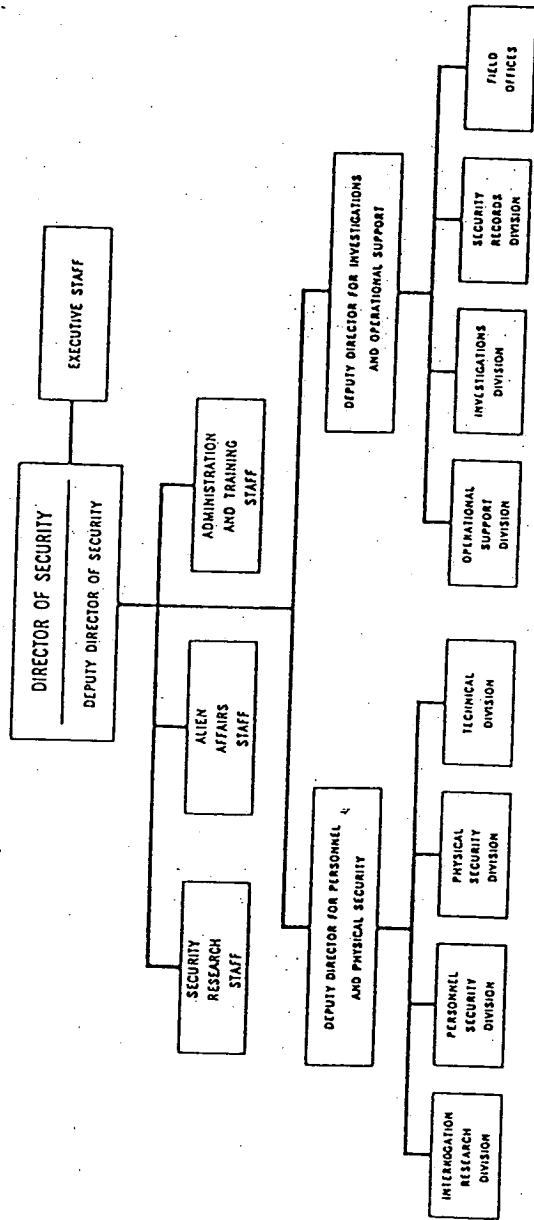

~~SECRET~~

HR 1, fig. 2.2

RECORDED BY HRL, Fig. 2.2 (P.W.H.S. 314)
DATED 3 Nov 66

ORGANIZATION

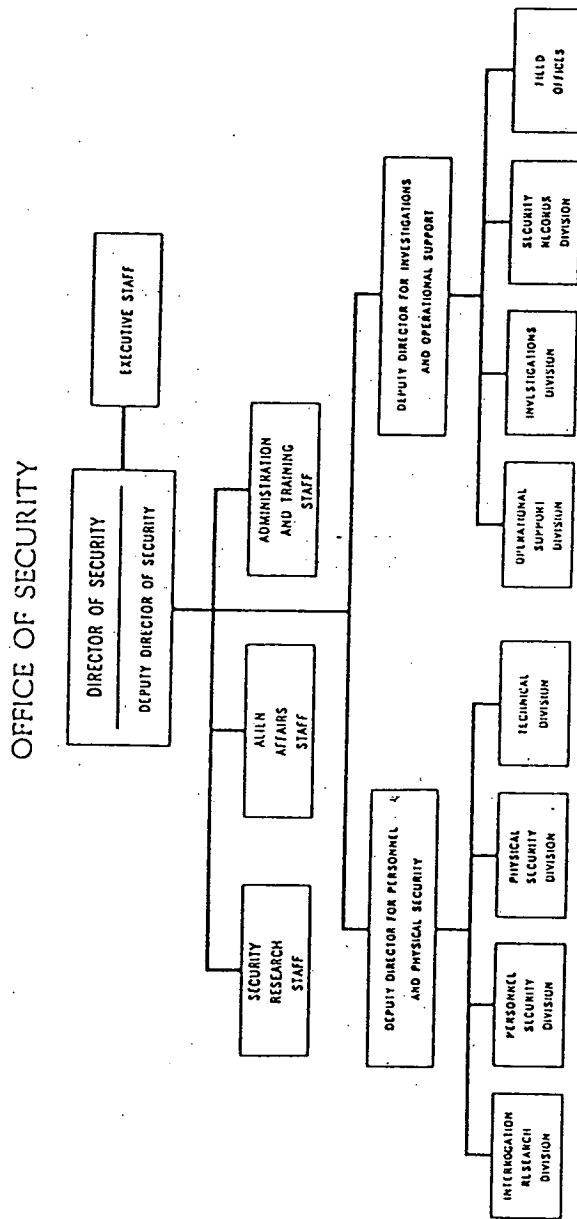

~~SECRET~~

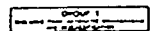

OFFICE OF SECURITY

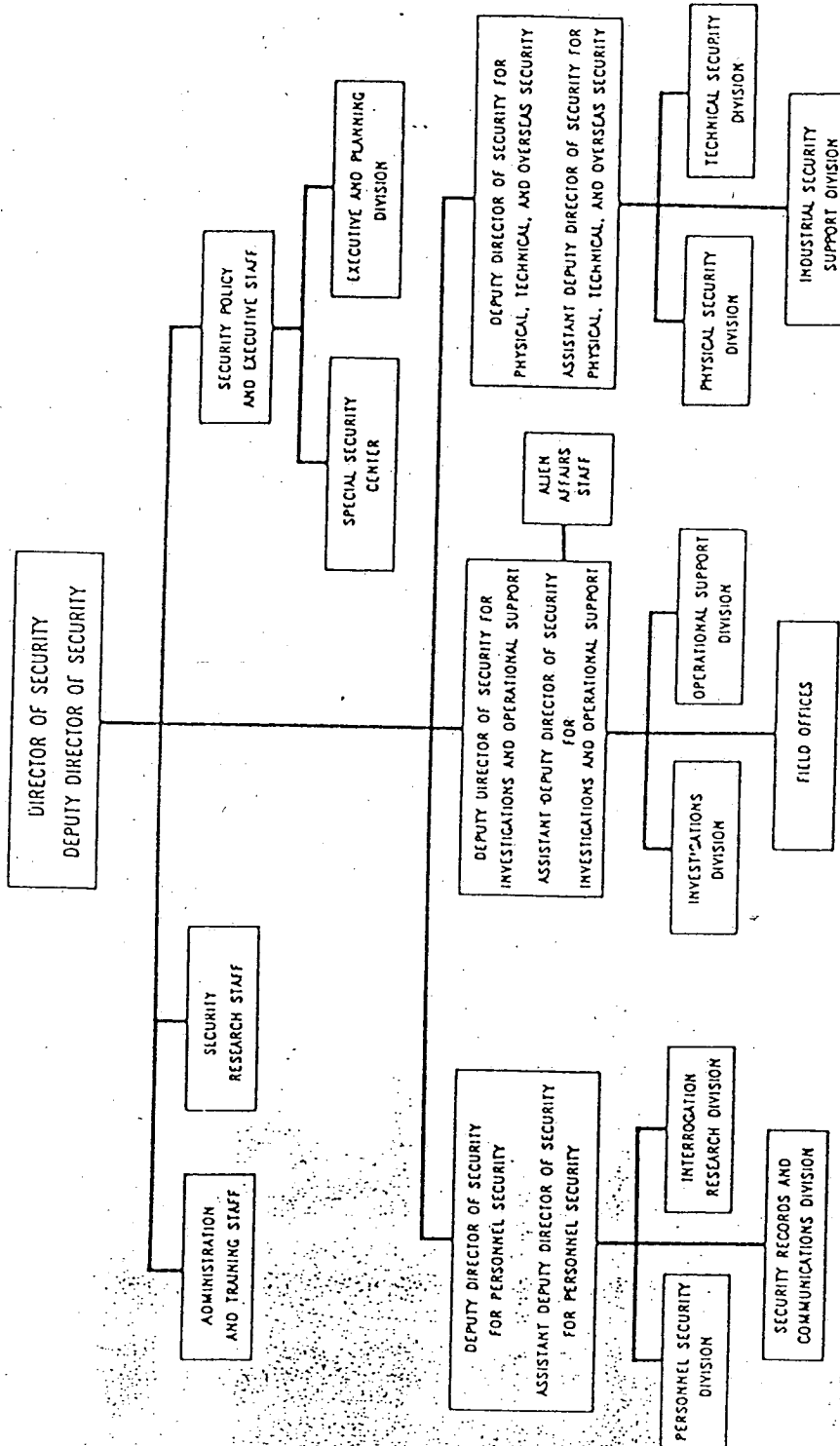

~~SECRET~~

CIA SPECIAL COLLECTIONS
RELEASE IN FULL
2000

25 May 1995

MEMORANDUM FOR: Mr. John Pereira
Historical Review Group/CSI

FROM: Becky L. Rant
DCI Executive Secretariat

SUBJECT: Assassination Records REview Board
Request No. CIA-1

REFERENCE: ER 95-8097, 6 Apr 95, Appointment of
Directorate Focal Points for JFK Assassination
Board Requests, with attachment.

1. In response to ARRB request # 1, a search of Executive Registry files produced 20 documents that may be useful in responding to paragraph (d), Page 3.

2. Also, a one page listing of CIA Liaison officials, taken from memory and discussions with present IMO's, is provided to assist in responding to Paragraph (b), Page 3. Some names and titles are contained in the 20 documents at attachment #1.

2 Atchs
1. 20 Docs
2. 1 Pg listing

¹⁵¹
Becky L. Rant

UNCLASSIFIED WITHOUT
ATTACHMENTS

~~SECRET~~

1. PURPOSE: FOIA PA JUSTICE IG OTHER
ARRB

2. REQUESTOR: ARRB
OFFICE: DCI/ES PHONE: _____

3. SUBJECTS/ITEMS REQUESTED:
ASSASSINATION Record Review Board

4. FILES, RETIRED JOB NUMBERS, ABSTRACTS SEARCHED AND LISTING OF ITEMS FOUND, CONTROL NUMBERS, ETC:

- #2 Job # 79m01476A Boxes (3) ^{non} 8, 21
- #6 # 80m01048A Box (4) 9, 10, 12
- 9 # 80m01066A Box (9) no (But file is here)
- ~~#3~~ 80m001657A box (8) no
- (2) 80R01284A (9) 94, (29) ^{yes}
- (2) nothing

5. ITEMS REVIEWED BY: _____ DATE: _____

6. RELEASED/DENIED: _____

7. TIME SPENT ON SEARCH: 2 hrs

8. OTHER COMMENT(S): _____

9. DATE OF COMPLETED ACTIONS: _____

2 - 75 - 77 (Yes)

(3) 76 - 77 - ~~Yes~~ (Yes)
80 M 00165A, BOX 8, FLD 0183

REVIEW
STAFF

(6) 1974 - Yes

(9) 73 + 75 (Yes)

(13) 71 - (Yes) 80 Q 0 1984A, BOX 4, FLD 4
24, 1
29, 2

(15) 63 - 69 (NO)

~~1976~~

(20) 1979

Central Intelligence Agency
Washington, D.C. 20505

Executive Secretariat
Information Review Officer

25 May 1995

Becky _____

Your approval and signature, right package.
(file cy and ref on left side)

Verified with Barry, that we do not need
to task IG and OGC, on Pg 2, at this time,
he is trying to get that info from RPD.

Also, on the list of names at Atch 2,
didn't want to try and pin down the
exact committee that they worked with,
maybe from all the info they pull in - -
will answer that part.

Jim P. 

*looks good
Jim. J
Agreed*

CIA SPECIAL COLLECTIONS
RELEASE IN FULL

2000

6 June 1995

NOTE FOR: THE FILE

SUBJECT: JFK Board Requests

On 5 June I called David Marwell to clarify parts of the Board's first three requests (CIA-1,2,and 3). The following points were made:

- Marwell will arrange to have a Board staffer screen the package of several hundred items provided by the DA in response to request no. 1. The items consist largely of HNs and HRs that describe organizations and appointments. This would preclude the need to send the entire package to the Board.
- Regarding requests no. 2 and 3, the reason that the Board has asked us to provide information as to the the present whereabouts of individuals is to help the Board determine which names should be released. For example, the Board may conclude that the name of someone who retired overtly and is living in the US could be released, as opposed to someone who retired under cover and lives abroad.
- If the Board wants to interview someone, a specific request will be sent to us.
- The background information that we provide on individuals and crypts listed in the requests is not considered part of the "assassination record." The information is used to assist the Board in its review of documents.
- On 7 June the Board will hold a "formal" meeting to review redactions we have recommended.

John Pereira



CENTER *for the* STUDY of INTELLIGENCE

4 August 1995

Mr. David G. Marwell
Executive Director
Assassination Records
Review Board
600 E Street, N.W.
Washington, DC 20530

Dear David:

1. The attached is in response to items (a)1, (a)5, and (b) of your Request No. CIA-1 dated 22 March 1995. In addition we have over 500 pages of material related to item (a)1 available for review by you and your staff.

2. Please contact me or Barry Harrelson if clarification is needed regarding the responses or to make arrangement to review the additional material.

Sincerely,

A handwritten signature in cursive script, appearing to read "John F. Pereira".

John F. Pereira
Chief, Historical Review Group

Attachment

UNCLASSIFIED WHEN SEPARATED
FROM ATTACHMENT

SUBJECT: Review of DO material for the JFK
Assassination Records Review Board
Request No. 1

REFERENCE:ARRB Additional Information Request No. CIA-1
dated 22 March 1995

1. The Assassination Records Review Board has requested per reference file material from various Agency Directorates on the JFK assassination. Part of the DO's contribution will focus on the names and affiliations of all CIA personnel responsible for liaison with the various commissions set up at that time to review the investigative work done on the JFK assassination.

2. In response to paragraph [a] [1.] of reference, we have located the following organizational charts on the following entities for the years 1958-1968:

[a.] Comprehensive Listings for the various divisions within the Directorate of Plans

[b.] Diagrams for the JMWAVE Station. At this time we have not located a diagram of the Mexico City Station. We will, however, continue to search our records for this information.

[c.] The two individuals who were involved in Task Force W were Desmond Fitzgerald and William Harvey.

3. Responsive to paragraph [b] of reference we have identified the following information:

[a.] The Warren Commission

1. Raymond G. Rocca - CI/OPS
Principal Coordinator
2. Richard Helms - DDP (DDO)
3. James Angleton - C/CI
4. David Murphy - C/SR
5. John Whitten - C/WH/3 (Mexico City Desk)
6. J.C. King - C/WH
7. Bruce Solie - OS/Investigations and Files
8. Thomas Hall - CI/R&A
9. Arthur Dooley - CI/R&A
10. Lee Wigren SR/CI/R

[b.] House Select Committee on Assassinations:

SUBJECT:

The individuals listed below were the official liaison contact with the HSCA staffers and served as the focal point between the Committee and the various CIA components in response to requests.

1. Scott Breckinridge -OLC (Office of Legislative counsel) Principal Coordinator
2. Roger Gabrielson - OLC
3. Patrick Carpenter - OLC
4. Douglas Cummins - OLC
5. George Cary - OLC
6. Lyle Miller - OLC

In addition we have listed below the name of certain individuals identified as providing support to OLC in responding to the various Committee requests:

1. Norbert Shepanek - SA/DO/O
2. Don Gregg - SA/DO/O
3. Phil Fendig - SA/DO/O
4. William Sturbitts - DO/LA
5. Russ Holmes - DO/CI/OG
6. Doris Houdesheldt - OP
7. Robert Kennedy - OP
8. George Kalaris - DO/C/CI
9. Ray Reardon - OS
10. Jack Sullivan - OS
11. Dick Rininger - OGC
12. Larry Houston - OGC
13. Jack Warner - OGC
14. Jim Pittman - Executive Registry
15. Jim Lucas - Executive Registry
16. Hal Clark - SA/DDS&T
17. Hubert Lacey - O/Finance
18. Mr. Young - O/Inspector General
19. Robert Wall - DO/ AC/CI/OG
20. Seymour Bolton - SA/DDCI
21. John Leader - O/Inspector General
22. Julian Fox - DO/SE
23. Dolores Tuohey - SA/DDCI
24. Mike Sednaoui - DO/CI

[c.] Rockefeller Commission:

We have listed below a number of individuals who were designated to be in liaison with Commission:

1. E.H. Knocke - SA/DCI
2. John Clarke - SA/DCI/IC

SUBJECT:

3. Don Chamberlain - OLC
4. Scott Breckenridge - O/Inspector General

~~SECRET~~

*See memo page
for rescission*
R 1-120

REGULATION
NO. 1-120

ORGANIZATION
Revised 16 August 1957

**ORGANIZATION AND FUNCTIONS
OFFICE OF THE DEPUTY DIRECTOR (PLANS)**

Rescissions: (1) R 1-120 dated 12 May 1955
(2) Paragraphs 1, 2a, 2b, and the first three sentences of 2c of
N 1-120-1 dated 31 January 1956

CONTENTS

	Page
MISSION	3
FUNCTIONS	3
ORGANIZATION	3

CIA SPECIAL COLLECTIONS
RELEASE IN FULL
2000

~~SECRET~~

*To be reviewed
(Comment)*

~~SECRET~~

R 1-120

REGULATION
NO. 1-120

ORGANIZATION
Revised 16 August 1957

ORGANIZATION AND FUNCTIONS

OFFICE OF THE DEPUTY DIRECTOR (PLANS)

1. MISSION

The Deputy Director (Plans) is responsible for the conduct of the Agency's espionage, counterespionage, and covert operations, and the planning and preparation for performance of such activities in wartime. The mechanism by which the Deputy Director (Plans) will discharge this responsibility will be the CIA clandestine services, within which will be integrated overseas clandestine organizations and activities, together with related assigned headquarters executive, staff, and operational elements.

2. FUNCTIONS

The Deputy Director (Plans) is the Director's deputy and channel for the direction and control of CIA clandestine activities. In this capacity, he is responsible to the Director for the establishment and direction of the clandestine services organization for the planning, execution, and review of the missions entrusted to the Director under NSCID-5 and NSC 5412/2 and to him is delegated the authority to carry out these functions.

3. ORGANIZATION (See organization chart, figure 1.)

a. HEADQUARTERS

The clandestine services headquarters organization will consist of such staff elements and such area or other operational divisions as the Deputy Director (Plans) may establish, through normal Agency procedures and subject to the Director's approval, for the execution of his responsibilities. The chief of each such operational division will be the channel of authority and communication from the Deputy Director (Plans) to the overseas or other organization within the assigned jurisdiction of his division.

b. FIELD

(1) The clandestine services will have overseas:

- (a) Such stations as may be established, subject to the Director's approval, for the performance and support of clandestine activities. Each chief of station will have full responsibility for matters within his assigned jurisdiction; he will report to and communicate with headquarters through the chief of the operational division having jurisdiction.
- (b) Such bases as may be established, subject to the Director's approval, subordinate to the above stations. Except as specifically authorized by the Director or the Deputy Director (Plans), and with the specific exception of FBIS material, each chief of base will report to and communicate with headquarters through the chief of station having jurisdiction.
- (c) Such senior war planners (SWP) as the Deputy Director (Plans) may establish, subject to the Director's approval. Each senior war planner will be under the direction of the Deputy Director (Plans). His reporting channel will be via the chief of station and chief of the operational division to the Deputy Director (Plans) and the Director.

~~SECRET~~

R 1-120

REGULATION
NO. 1-120

ORGANIZATION
Revised 16 August 1957

- (2) Also there will be maintained overseas such elements as the Director may specify for the performance and support of the nonclandestine responsibilities of CIA. All such elements and the personnel thereof, unless specifically exempted by the Deputy Director (Plans) and the other Deputy concerned will be under the administrative authority of the responsible chief of station in the area. In the event of failure of the two Deputies to agree, the matter will be placed before the Director for decision.

FOR THE DIRECTOR OF CENTRAL INTELLIGENCE:

L. K. WHITE
Deputy Director
(Support)

DISTRIBUTION: A
4B

~~SECRET~~

*Revised by
R1-120 Revised 26 August 58*

R1-120
ORGANIZATION
Revised 16 August 1957

~~SECRET~~

OFFICE OF THE DEPUTY DIRECTOR (PLANS)

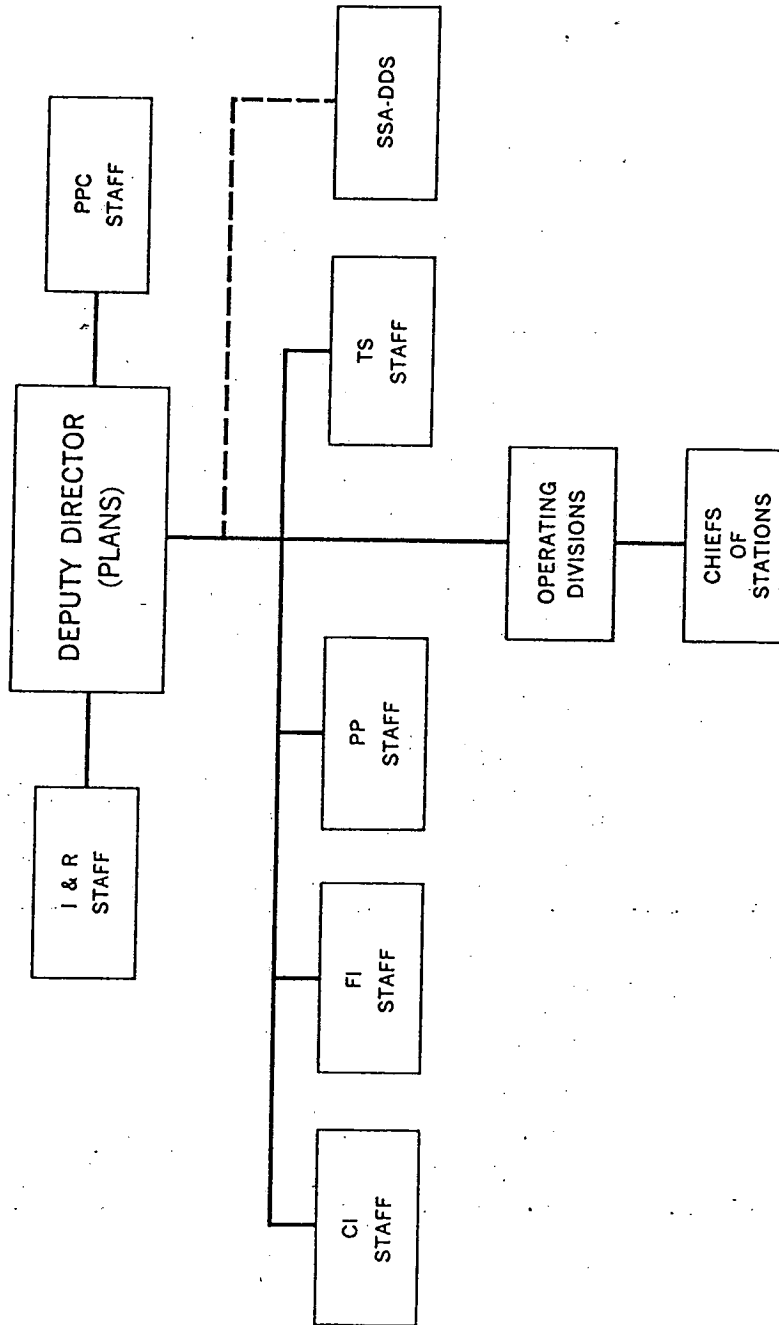

Figure 1

~~SECRET~~

REGULATION
NO. 1-120

13105 8-57

~~SECRET~~

REGULATION
NO. 1-120

R 1-120
ORGANIZATION
Revised 26 August 1958

OFFICE OF THE DEPUTY DIRECTOR (PLANS)

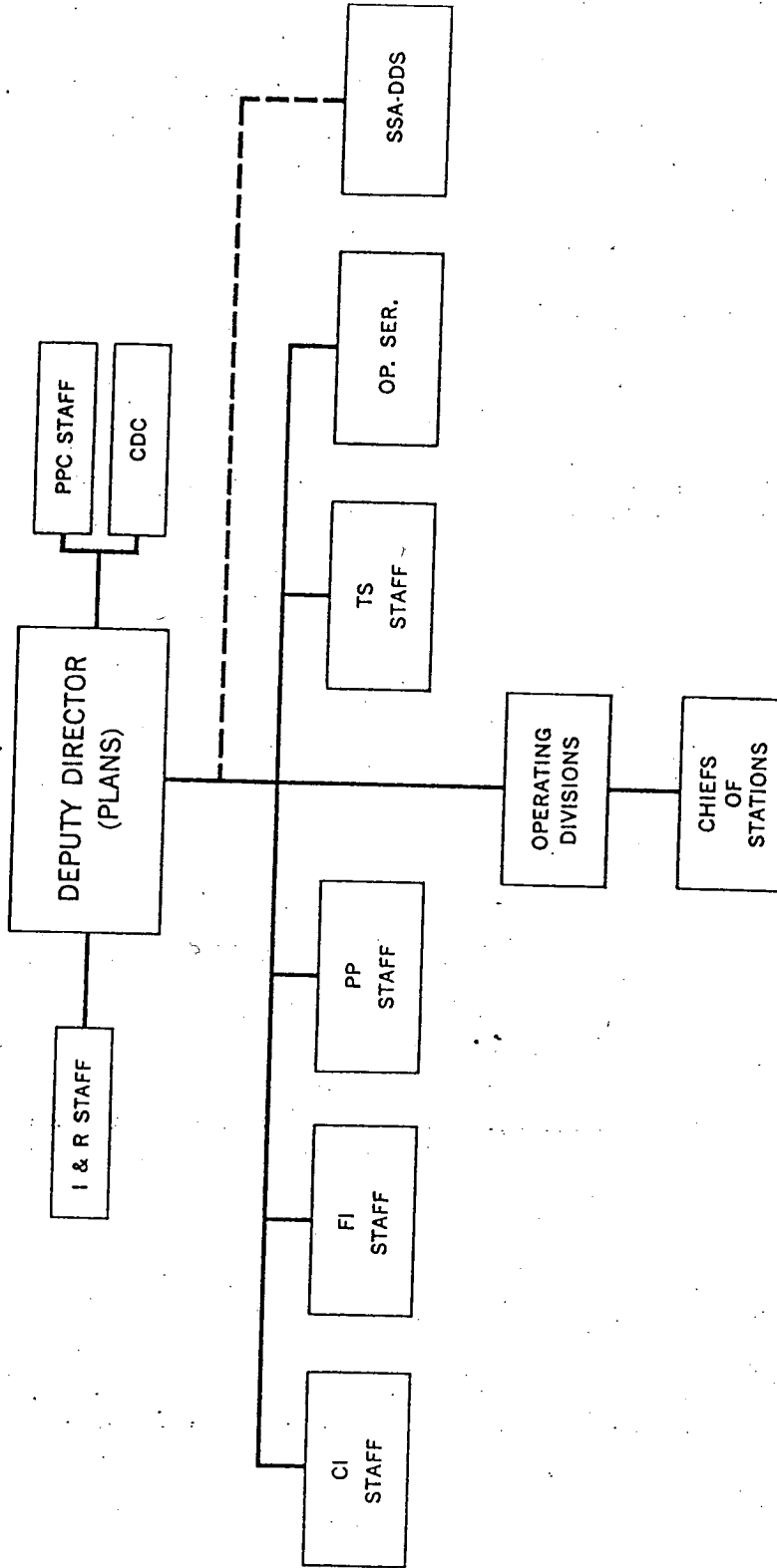

Figure 1

~~SECRET~~

13105 9-58

REGULATIONS
CONTROL STAFF
SEP 12 3 20 PM '58

*Rescinded by HR 1-12 dated
1 April 1961 per Inst. Sheet No.*
~~SECRET~~ R 1-120

REGULATION
NO. 1-120

ORGANIZATION
Revised 3 March 1960

ORGANIZATION AND FUNCTIONS

OFFICE OF THE DEPUTY DIRECTOR (PLANS)

Rescission: R 1-120 and Figure 1 dated 16 August 1957 and 26 August 1958, ✓
respectively ✓

1. MISSION

The Deputy Director (Plans) is responsible for the conduct of the Agency's espionage, counterespionage, and covert operations, and the planning and preparation for performance of such activities in wartime. The mechanism by which the Deputy Director (Plans) will discharge this responsibility will be the CIA clandestine services, within which will be integrated overseas clandestine organizations and activities, together with related assigned headquarters executive, staff, and operational elements.

2. FUNCTIONS

The Deputy Director (Plans) is the Director's deputy and channel for the direction and control of CIA clandestine activities. In this capacity, he is responsible to the Director for the establishment and direction of the clandestine services organization for the planning, execution, and review of the missions entrusted to the Director under NSCID-5 and NSC 5412/2 and to him is delegated the authority to carry out these functions.

3. ORGANIZATION

a. HEADQUARTERS

The clandestine services headquarters organization will consist of such staff elements and such area or other operational divisions as the Deputy Director (Plans) may establish, through normal Agency procedures and subject to the Director's approval, for the execution of his responsibilities. The chief of each such operational division will be the channel of authority and communication from the Deputy Director (Plans) to the overseas or other organization within the assigned jurisdiction of his division.

b. FIELD

(1) The clandestine services will have overseas:

- (a) Such stations as may be established, subject to the Director's approval, for the performance and support of clandestine activities. Each chief of station will have full responsibility for matters within his assigned jurisdiction; he will report to and communicate with headquarters through the chief of the operational division having jurisdiction.
- (b) Such bases as may be established, subject to the Director's approval, subordinate to the above stations. Except as specifically authorized by the Director or the Deputy Director (Plans), and with the specific exception of FBIS material, each chief of base will report to and communicate with headquarters through the chief of station having jurisdiction.
- (c) Such senior war planners as the Deputy Director (Plans) may establish, subject to the Director's approval. Each senior war planner will be under the direction of the Deputy Director (Plans). His reporting channel will be via the chief of station and chief of the operational division to the Deputy Director (Plans) and the Director.

~~SECRET~~

*Revised by HR 1-12 dit
1 April 1961 per Dret. Sheet X*

R 1-120 ²

REGULATION
NO. 1-120

ORGANIZATION
Revised 3 March 1960

(2) Also there will be maintained overseas such elements as the Director may specify for the performance and support of the nonclandestine responsibilities of CIA. All such elements and the personnel thereof, unless specifically exempted by the Deputy Director (Plans) and the other Deputy concerned will be under the administrative authority of the responsible chief of station in the area. In the event of failure of the two Deputies to agree, the matter will be placed before the Director for decision.

FOR THE DIRECTOR OF CENTRAL INTELLIGENCE:

L. K. WHITE
Deputy Director
(Support)

DISTRIBUTION: A
4B

~~SECRET~~

09 APR 27 01 00 1961
SECRET

~~SECRET~~

ORGANIZATION

RECORDED BY

HR1

HR 1-12

DATE 16 Aug 63

12. OFFICE OF THE DEPUTY DIRECTOR (PLANS)

- a. **MISSION.** The Deputy Director (Plans) is responsible for the conduct of the Agency's espionage, counterespionage, and covert operations, and the planning and preparation for performance of such activities in wartime. The mechanism by which the Deputy Director (Plans) will discharge this responsibility will be the CIA clandestine services, within which will be integrated overseas clandestine organizations and activities, together with related assigned headquarters executive, staff, and operational elements.
- b. **FUNCTIONS.** The Deputy Director (Plans) is the Director's deputy and channel for the direction and control of CIA clandestine activities. In this capacity, he is responsible to the Director for the establishment and direction of the clandestine services organization for the planning, execution, and review of the missions entrusted to the Director under NSCID-5 and NSC 5412/2 and to him is delegated the authority to carry out these functions.
- c. **ORGANIZATION**
- (1) **HEADQUARTERS.** The clandestine services headquarters organization will consist of such staff elements and such area or other operational divisions as the Deputy Director (Plans) may establish, through normal Agency procedures and subject to the Director's approval, for the execution of his responsibilities. The chief of each such operational division will be the channel of authority and communication from the Deputy Director (Plans) to the overseas or other organization within the assigned jurisdiction of his division.
- (2) **FIELD**
- (a) The clandestine services will have overseas:
- (1) Such stations as may be established, subject to the Director's approval, for the performance and support of clandestine activities. Each Chief of Station will have full responsibility for matters within his assigned jurisdiction; he will report to and communicate with headquarters through the chief of the operational division having jurisdiction.
- (2) Such bases as may be established, subject to the Director's approval, subordinate to the above stations. Except as specifically authorized by the Director or the Deputy Director (Plans), and with the specific exception of FBIS material, each Chief of Base will report to and communicate with headquarters through the Chief of Station having jurisdiction.
- (3) Such senior war planners as the Deputy Director (Plans) may establish, subject to the Director's approval. Each senior war planner will be under the direction of the Deputy Director (Plans). His reporting channel will be via the Chief of Station and chief of the operational division to the Deputy Director (Plans) and the Director.
- (b) Also there will be maintained overseas such elements as the Director may specify for the performance and support of the nonclandestine responsibilities of CIA. All such elements and the personnel thereof, unless specifically exempted by the Deputy Director (Plans) and the other Deputy concerned, will be under the administrative authority of the responsible Chief of Station in the area. In the event of failure of the two Deputies to agree, the matter will be placed before the Director for decision.

Revised: 1 April 1961

~~SECRET~~

7

ORGANIZATION ...

~~SECRET~~

HR-12

Qu HFS
#521

HR 1-12

24 Feb 70

12. OFFICE OF THE DEPUTY DIRECTOR FOR PLANS

- a. **MISSION.** The Deputy Director for Plans is responsible for the conduct of the Agency's espionage, counterintelligence, and covert operations, and the planning and preparation for performance of such activities in wartime. The mechanism by which the Deputy Director for Plans will discharge this responsibility will be the CIA clandestine services, within which will be integrated overseas clandestine organizations and activities, together with related assigned headquarters executive, staff, and operational elements.
- b. **FUNCTIONS.** The Deputy Director for Plans is the Director's deputy and channel for the direction and control of CIA clandestine activities. In this capacity he is responsible to the Director for the establishment and direction of the clandestine services organization for the planning, execution, and review of the missions entrusted to the Director under NSCID-5 and NSC 5412/2 and to him is delegated the authority to carry out these functions.
- c. **ORGANIZATION**
- (1) **HEADQUARTERS.** The clandestine services headquarters organization will consist of such staff elements and such area or other operational divisions as the Deputy Director for Plans may establish, through normal Agency procedures and subject to the Director's approval, for the execution of his responsibilities. The chief of each such operational division will be the channel of authority and communication from the Deputy Director for Plans to the overseas or other organization within the assigned jurisdiction of his division.
- (2) **FIELD**
- (a) The clandestine services will have overseas:
- (1) Such stations as may be established, subject to the Director's approval, for the performance and support of clandestine activities. Each Chief of Station will have full responsibility for matters within his assigned jurisdiction; he will report to and communicate with headquarters through the chief of the operational division having jurisdiction.
- (2) Such bases as may be established, subject to the Director's approval, subordinate to the above stations. Except as specifically authorized by the Director or the Deputy Director for Plans, and with the specific exception of FBIS material, each Chief of Base will report to and communicate with headquarters through the Chief of Station having jurisdiction.
- (3) Such senior war planners as the Deputy Director for Plans may establish, subject to the Director's approval. Each senior war planner will be under the direction of the Deputy Director for Plans. His reporting channel will be via the Chief of Station and chief of the operational division to the Deputy Director for Plans and the Director.
- (b) Also there will be maintained overseas such elements as the Director may specify for the performance and support of the nonclandestine responsibilities of CIA. All such elements and the personnel thereof, unless specifically exempted by the Deputy Director for Plans and the other Deputy concerned, will be under the administrative authority of the responsible Chief of Station in the area. In the event of failure of the two Deputies to agree, the matter will be placed before the Director for decision.

Revised: 25 November 1968 (425)

Dist: less than AB

~~SECRET~~

GROUP 1
Excluded from automatic
downgrading and declassification

ORGANIZATION

~~SECRET~~

HR 1-12

*Per HJS
#425*

HR 1-12

25 Nov 68

12. OFFICE OF THE DEPUTY DIRECTOR FOR PLANS

- a. **MISSION.** The Deputy Director for Plans is responsible for the conduct of the Agency's espionage, counterespionage, and covert operations, and the planning and preparation for performance of such activities in wartime. The mechanism by which the Deputy Director for Plans will discharge this responsibility will be the CIA clandestine services, within which will be integrated overseas clandestine organizations and activities, together with related assigned headquarters executive, staff, and operational elements.
- b. **FUNCTIONS.** The Deputy Director for Plans is the Director's deputy and channel for the direction and control of CIA clandestine activities. In this capacity, he is responsible to the Director for the establishment and direction of the clandestine services organization for the planning, execution, and review of the missions entrusted to the Director under NSCID-5 and NSC 5412/2 and to him as delegated the authority to carry out these functions.
- c. **ORGANIZATION**
- (1) **HEADQUARTERS.** The clandestine services headquarters organization will consist of such staff elements and such area or other operational divisions as the Deputy Director for Plans may establish, through normal Agency procedures and subject to the Director's approval, for the execution of his responsibilities. The chief of each such operational division will be the channel of authority and communication from the Deputy Director for Plans to the overseas or other organization within the assigned jurisdiction of his division.
- (2) **FIELD**
- (a) The clandestine services will have overseas:
- (1) Such stations as may be established, subject to the Director's approval, for the performance and support of clandestine activities. Each Chief of Station will have full responsibility for matters within his assigned jurisdiction; he will report to and communicate with headquarters through the chief of the operational division having jurisdiction.
- (2) Such bases as may be established, subject to the Director's approval, subordinate to the above stations. Except as specifically authorized by the Director or the Deputy Director for Plans, and with the specific exception of FBIS material, each Chief of Base will report to and communicate with headquarters through the Chief of Station having jurisdiction.
- (3) Such senior war planners as the Deputy Director for Plans may establish, subject to the Director's approval. Each senior war planner will be under the direction of the Deputy Director for Plans. His reporting channel will be via the Chief of Station and chief of the operational division to the Deputy Director for Plans and the Director.
- (b) Also there will be maintained overseas such elements as the Director may specify for the performance and support of the nonclandestine responsibilities of CIA. All such elements and the personnel thereof, unless specifically exempted by the Deputy Director for Plans and the other Deputy concerned, will be under the administrative authority of the responsible Chief of Station in the area. In the event of failure of the two Deputies to agree, the matter will be placed before the Director for decision.

Revised: 16 August 1963

** Dist. L...*

~~SECRET~~

GROUP 1
Excluded from automatic
downgrading and
declassification

31

~~MASTER COPY~~

~~CONFIDENTIAL~~

This Notice Expires 1 November 1962 *revised*

ORGANIZATION

HN 1-19
23 April 1962

OFFICE OF THE DEPUTY DIRECTOR (PLANS)

Effective 1 May 1962 there is established in the Office of the Deputy Director (Plans) the position of Assistant Deputy Director (Plans) (ADDP). The functions of this position will be the same as those of the present position of Chief of Operations, which it replaces. Mr. Thomas H. Karamessines will be the Assistant Deputy Director (Plans).

Marshall S. Carter
MARSHALL S. CARTER
Lieutenant General, USA
Acting Director of Central Intelligence

DISTRIBUTION: AB

52 MAY 21 8 25 AM '62

~~CONFIDENTIAL~~

~~MASTER COPY~~

RECORDED BY Hy Inst. Sheet #11
DATED 16 Aug 63

~~CONFIDENTIAL~~

ORGANIZATION

HN 1-8
14 February 1962

1. Effective 17 February 1962, Mr. Richard Helms is appointed Deputy Director (Plans) vice Mr. Richard Bissell who has submitted his resignation.
2. The organization of the DD/P is currently being studied and certain changes are contemplated. There will be created a Deputy Director for Research and Development and certain of the Research and Development functions now administered by the Deputy Director (Plans) will be transferred to that Deputy.
3. Additional announcements will be made in the near future.

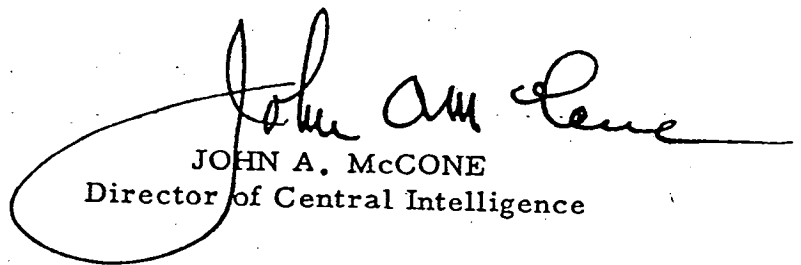
JOHN A. McCONE
Director of Central Intelligence

DISTRIBUTION: AB

CC
SEE

LES 12 3 2 11

~~CONFIDENTIAL~~



Assassination Records Review Board
600 E Street NW • 2nd Floor • Washington, DC 20530
(202) 724-0088 • Fax: (202) 724-0457

October 7, 1996

HAND DELIVERY

Mr. Barry Harrelson
Historical Review Group
Center for the Study of Intelligence
Central Intelligence Agency
Washington, D.C. 20505

CIA HAS NO OBJECTION TO
DECLASSIFICATION AND/OR
RELEASE OF CIA INFORMATION
IN THIS DOCUMENT

Re: Status of Assassination Records Review Board Requests to CIA for
Additional Information and Records

Dear Barry:

I am writing to memorialize our conversation of October 1 regarding the status of Assassination Records Review Board requests for information and records from the CIA.

We discussed the following formal requests:

CIA-1 (Organization materials)

CIA has made records available to the Review Board. The Review Board staff will continue its review and make recommendations to the Board and will request further information, if necessary, from CIA. CIA needs to do nothing further at this time.

CIA-2-5 Complete

CIA-6 (Cables and dispatches)

CIA originally informed the Review Board staff that these materials could be made available by December, 1995. CIA now agrees to make the records available (or to have a response) by the first of November, 1996.

CIA-7 (Histories)

Mexico City. CIA has shown the Mexico City history to Gunn. CIA will compile the portion of the history that was shown to G. Robert Blakey,

BOARD MEMBERS: John R. Tunheim, Chair • Henry F. Graff • Kermit L. Hall • William L. Joyce • Anna K. Nelson
EXECUTIVE DIRECTOR: David G. Marwell

Mr. Barry Harrelson
October 7, 1996
Page 2

which will be processed as an assassination record. Gunn will then determine whether there are any additional portions of the history that should be added to the Blakey version. CIA will compile the "Blakey version" as soon as possible and Gunn will promptly thereafter review the documents.

Index. CIA has made an index available to Review Board staff and the staff has identified certain histories that may be appropriate for review. CIA will make available those histories that are of obvious relevance, and will raise with Review Board staff any questions regarding the requests where the basis for the request is unclear. CIA will begin to make histories available on a rolling basis. Review Board has agreed to review histories promptly once they are made available. Although it was not discussed at our meeting, we would very much appreciate it if you would, within the next two weeks, identify which histories you are prepared to make available and those that CIA believes should be subject to further discussions.

Cram's multi-volume counterintelligence history. Although Cram's history was not specifically discussed at our meeting, the Review Board staff understands that the history has been located and the Review Board staff awaits its being made available.

CIA-8 (Intelligence community staff)

CIA will provide a report to the Review Board staff within two weeks.

CIA-9 (Publications and analytical materials)

The Review Board staff provided CIA with a list of certain publications as they appear in an LBJ Library finding aid. CIA will report back on recommended action to the Review Board promptly.

CIA-10 (Interagency source register)

CIA has compiled information responsive to the request. CIA will make records available within two weeks.

CIA-11 (Duran's original statement)

Mr. Barry Harrelson
October 7, 1996
Page 3

CIA has been unable to identify to date Duran's original statement. CIA will make some further attempts to locate it.

CIA-12 (JMWAVE materials)

CIA will begin to make materials available on a rolling basis.

With respect to the informal requests, it is our understanding that:

CIA is inquiring into matters related to Spas Raikin. The Review Board staff will discuss issues with CIA once the pending research is completed.

CIA is locating a cable number IN 24738 (7 July 62), which is identified in record number 1993.07.20.10.18:29:650630 (Box 34, F 22), p. 2.

CIA is inquiring into matters related to Marilyn D. Murrett. The Review Board staff will discuss issues with CIA once the pending research is completed.

CIA is continuing to search for HTLINGUAL records, particularly those identified in Church Committee index that was provided to CIA by Review Board staff. CIA is prepared to provide oral briefing on HTLINGUAL.

Please let me know if you have any supplements or corrections. We would very much like to ensure that these matters are handled expeditiously.

As always, thanks for your cooperation and assistance.

Sincerely,

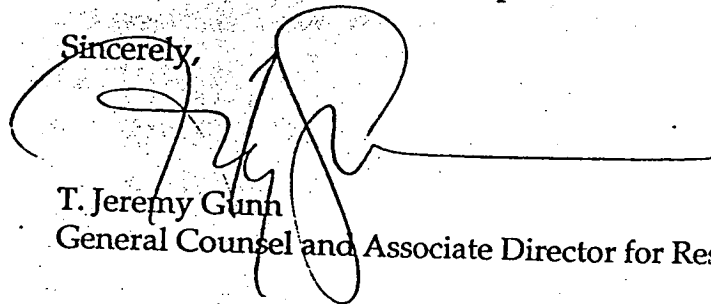

T. Jeremy Gunn
General Counsel and Associate Director for Research



work copy

Assassination Records Review Board
600 E Street NW • 2nd Floor • Washington, DC 20530
(202) 724-0088 • Fax: (202) 724-0457

October 27, 1996

Mr. Barry Harrelson
Historical Review Group
Center for the Study of Intelligence
Central Intelligence Agency
Washington, D.C. 02505

CIA HAS NO OBJECTION TO
DECLASSIFICATION AND/OR
RELEASE OF CIA INFORMATION
IN THIS DOCUMENT

Re: Status of Assassination Records Review Board Requests to CIA for
Additional Information and Records

Dear Barry:

I am writing to follow-up on our letter of October 7, 1996, regarding the status of Assassination Records Review Board requests for information and records from the CIA.

Formal Requests:

~~SECRET~~

Review Board staff review continues. No CIA action needed at this time.

CIA-6 (Cables and dispatches)

CIA has agreed to make records available (or to have a response) by November 1, 1996.

CIA-7 (Histories)

Counterintelligence. CIA has made material available and Review Board staff examination is ongoing.

Mexico City. The Review Board awaits CIA's compilation of the portion of the Mexico Station history that was shown to G. Robert Blakey.

Mr. Barry Harrelson
October 27, 1996
Page 2

Other Histories. No response has been received to our agreement that CIA identify within two weeks the histories that can be made available and those that should be subject to further discussions.

CIA-8 (Intelligence community staff)

CIA had promised to provide a report to the Review Board within two weeks. Nothing has been made available.

CIA-9 (Publications and analytical materials)

We have received no materials responsive to this request. Additionally, no response has been received from CIA regarding the list of publications that are identified in an LBJ Library finding aid that the Review Board staff provided.

CIA-10 (Interagency source register)

CIA has not yet made available the records that it had agreed to provide within two weeks. *(was Oswald on)*

CIA-11 (Duran's original statement)

CIA has agreed to make some further attempts to locate Duran's original statement.

CIA-12 (JMWAVE materials)

CIA has agreed to make materials available on a rolling basis.

Informal requests:

Spas Rankin. CIA has made the Spas Rankin file available to the Review Board. Review Board staff research continues. When research is complete, staff will discuss issues with CIA. *files from collection pulled/waiting*

ARRIS staff review
IN 23738. CIA is searching for cable number IN 23738 (7 July 1962). - copy sent

Marilyn Murrett. CIA has made the Marilyn Murrett file available to the Review Board. Review Board staff research continues. When research is complete, staff

Mr. Barry Harrelson
October 27, 1996
Page 3

will discuss issues with CIA.

HTLINGUAL. It is the Review Board staff's understanding that CIA continues its search for HTLINGUAL records and will provide an oral briefing on the subject. It is also our understanding that some HTLINGUAL records have been located, but that they have not yet been made available to the Review Board.

Recent and additional informal requests that we have discussed with you:

Operational Reports for Cuban Exile Groups. The Review Board staff has been unable to locate in the collection monthly operational reports for the DRE, CRC, or MRR for the period between March 1963 and March 1964. Please advise us whether these records exist and when we may review them.

Moscow. CIA has been asked to search for additional information regarding Mosco as discussed with Michelle Combs on October 24, 1996.

Tape. CIA has been asked to search for additional information regarding a tape as discussed with Irene Marr on October 24, 1996.

Please let me know of any inaccuracies in this letter or any suggestions that you have. Thank you for your help and cooperation.

Sincerely,



T. Jeremy Gunn
General Counsel and Associate Director for Research

~~SECRET~~

24 January 1997

MEMORANDUM FOR: Teresa Wilcox
DS&T Focal Point for JFK Board

FROM: J. Barry Harrelson
JFK Project Office
DCI/CSI/HRG

SUBJECT: JFK Board Request

REFERENCE: ARRB Additional Information
Request No. CIA-1 (attached)

1. The enclosed material is part of your office's response to CIA-1.

2. We have been asked by the Staff of the John F. Kennedy Assassination Records Review Board to declassify the materials under the John F. Kennedy Assassination Records Review Act.

3. We ask your coordination in this effort and would appreciate a reply by 3 February 1997. If you have any questions, please call Jim Hanrahan (31809) or Barry Harrelson (31825).

J. Barry Harrelson

Atts:

- (1) Ref Doc
- (2) Portions of response to CIA-1

~~SECRET~~

~~SECRET~~

24 January 1997

MEMORANDUM FOR: Dick Flynn
DI Focal Point for JFK Board

FROM: J. Barry Harrelson
JFK Project Office
DCI/CSI/HRG

SUBJECT: JFK Board Request

REFERENCE: ARRB Additional Information
Request No. CIA-1 (attached)

1. The enclosed material is part of your office's response to CIA-1.
2. We have been asked by the Staff of the John F. Kennedy Assassination Records Review Board to declassify the materials under the John F. Kennedy Assassination Records Review Act.
3. We ask your coordination in this effort and would appreciate a reply by 3 February 1997. If you have any questions, please call Jim Hanrahan (31809) or Barry Harrelson (31825).

J. Barry Harrelson

Atts:

- (1) Ref Doc
- (2) Portions of response to CIA-1

~~SECRET~~

~~SECRET~~

24 January 1997

MEMORANDUM FOR: Kathryn Dyer
DCI Area Focal Point for JFK Board

FROM: J. Barry Harrelson
JFK Project Office
DCI/CSI/HRG

SUBJECT: JFK Board Request

REFERENCE: ARRB Additional Information
Request No. CIA-1 (attached)

1. The enclosed material is part of your office's response to CIA-1.

2. We have been asked by the Staff of the John F. Kennedy Assassination Records Review Board to declassify the materials under the John F. Kennedy Assassination Records Review Act.

3. We ask your coordination in this effort and would appreciate a reply by 3 February 1997. If you have any questions, please call Jim Hanrahan (31809) or Barry Harrelson (31825).

J. Barry Harrelson

Atts:

- (1) Ref Doc
- (2) Portions of response to CIA-1

~~SECRET~~

TRANSMITTAL SLIP		DATE 1/24/97
TO: Katie Nakai, OPS		
ROOM NO. 1S12	BUILDING Stafford Bldg.	
REMARKS: Katie, Attached is a request from CSI/HRG for a declassification review of materials requested by the JFK Board. Would you please review the records and provide me with your response as soon as you possibly can. Please note CSI's deadline of 3 February. Thanks in advance for your assistance. Frieda		
FROM:		
ROOM NO. 2B17	BUILDING IP	EXTENSION 31201

FORM NO.
1 FEB 56 241

REPLACES FORM 36-8
WHICH MAY BE USED.

(47)

~~SECRET~~

24 January 1997

MEMORANDUM FOR: Lee Strickland
DA Focal Point for JFK Board

FROM: J. Barry Harrelson
JFK Project Office
DCI/CSI/HRG

SUBJECT: JFK Board Request

REFERENCE: ARRB Additional Information
Request No. CIA-1 (attached)

1. The enclosed material is part of your office's response to CIA-1.

2. We have been asked by the Staff of the John F. Kennedy Assassination Records Review Board to declassify the materials under the John F. Kennedy Assassination Records Review Act.

3. We ask your coordination in this effort and would appreciate a reply by 3 February 1997. If you have any questions, please call Jim Hanrahan (31809) or Barry Harrelson (31825).

J. Barry Harrelson

Atts:
(1) Ref Doc
(2) Portions of response to CIA-1

~~SECRET~~

SECURE FACSIMILE TRANSMITTAL FORM

RCVD
2/10/97
1445 HRS
CAC

DATE: FEB. 10, 1997

SENDING SECURE/FAX TELEPHONE NUMBER: (703) 242-3682

RECEIVING SECURE/FAX TELEPHONE NUMBER: (703) 613-3002

NUMBER OF PAGES (Including Transmittal Form and Coversheet, if applicable) 16

FROM: PAT SIMMONS OC/ERO X30814
(Name / Office / Extension)

SUBJECT: _____

TO: (ADDRESSEE / ORGANIZATION / OFFICE / EXTENSION)

- 1. FRIEDA O. DDA/ERO 31200
- 2. _____
- 3. _____
- 4. _____
- 5. _____
- 6. _____
- 7. _____
- 8. _____
- 9. _____
- 10. _____

SPECIAL INSTRUCTIONS: REDACTIONS WERE MADE ON THE OC/ORG CHART UNDER OC/OPS, + SPECIAL PROGRAM STAFF (SQUARE).

REG 1-140 PARA (1),(4),(6). REASON: COM 11-82

RELEASING OFFICIAL: PATRICIA A. SIMMONS (PRINTED NAME) [Signature] (SIGNATURE)

RECEIVING STATION USE ONLY

Please receipt for material by entering time of receipt/signature and transmit back to sending station.

DATE/TIME: _____ SIGNATURE: _____

FORM 16-91 4383A

~~SECRET~~
(CLASSIFICATION OF MATERIAL TRANSMITTED)

ROUTING AND RECORD SHEET

SUBJECT: (Optional)

FROM:
DCI/IRO
6E2914 OHB

EXTENSION

NO.

39058

DATE

13 February 1997

TO: (Officer designation, room number, and building)

DATE

RECEIVED

FORWARDED

OFFICER'S INITIALS

COMMENTS (Number each comment to show from whom to whom. Draw a line across column after each comment.)

1. CRES
5F43 OHB

18
FEB
97

20
FEB
97

[Handwritten initials]

Attached are copies of various regulations relating to mission & functions. Please review those portions which relate to your office and/or responsibilities. The Staff of the JFK Assassination Review Board has asked that these be declassified and released. (Some material is AIUO.) Please indicate concurrence in the release of this information. (If object, please bracket sensitive information and provide a written explanation detailing the damage.) Response is needed by COB 18 February. Thank you.

K. Dyer
DCI/IRO

CRES - Although this position no longer exists, please review functions statement.

7. RETURN TO:
DCI/IRO 6E2914

ROUTING AND RECORD SHEET

SUBJECT: (Optional)

FROM:
DCI/IRO
6E2914 OHB

EXTENSION

NO.

39058

DATE

13 February 1997

TO: (Officer designation, room number, and building)

DATE

OFFICER'S INITIALS

COMMENTS (Number each comment to show from whom to whom. Draw a line across column after each comment.)

RECEIVED FORWARDED

1. O/COMPT. - D Warbrich
7B20 OHB.

2.

3.

4.

5.

6.

7.

8.

Cynthia Eschine

9.

10.

11.

12.

13.

14.

15.

Attached are copies of various regulations relating to mission & functions. Please review those portions which relate to your office and/or responsibilities. The Staff of the JFK Assassination Review Board has asked that these be declassified and released. (Some material is AIUO.) Please indicate concurrence in the release of this information. (If object, please bracket sensitive information and provide a written explanation detailing the damage.) Response is needed by COB 18 February. Thank you.

K. Dyer
DCI/IRO

8) Please review paper clipped items and return to me for handwritten check to Kelly

J. Dyer

37762

2/21/97

I don't see any problems with these documents.

CDG

ROUTING AND RECORD SHEET

SUBJECT: (Optional)

FROM:
DCI/IRO
6E2914 OHB

EXTENSION

NO.

39058

DATE

13 February 1997

TO: (Officer designation, room number, and building)

DATE

OFFICER'S INITIALS

COMMENTS (Number each comment to show from whom to whom. Draw a line across column after each comment.)

RECEIVED FORWARDED

1. OCA - S. Mauck
7C38

13 Feb 97

DM

Attached are copies of various regulations relating to mission & functions. Please review those portions which relate to your office and/or responsibilities. The Staff of the JFK Assassination Review Board has asked that these be declassified and released. (Some material is AIUO.) Please indicate concurrence in the release of this information. (If object, please bracket sensitive information and provide a written explanation detailing the damage.) Response is needed by COB 18 February. Thank you.

K. Dyer
DCI/IRO

See Office of Legislative Counsel.

10.

11.

12.

13.

14.

15.

ROUTING AND RECORD SHEET

SUBJECT: (Optional)				
FROM: DCI/IRO 6E2914 OHB			EXTENSION 39058	NO. DATE 13 February 1997
TO: (Officer designation, room number, and building)	DATE		OFFICER'S INITIALS	COMMENTS (Number each comment to show from whom to whom. Draw a line across column after each comment.)
	RECEIVED	FORWARDED		
1. OGC - Steve DeVine 7C24 OHB				<p>Attached are copies of various regulations relating to mission & functions. Please review those portions which relate to your office and/or responsibilities. The Staff of the JFK Assassination Review Board has asked that these be declassified and released. (Some material is AIUO.) Please indicate concurrence in the release of this information. (If object, please bracket sensitive information and provide a written explanation detailing the damage.) Response is needed by COB 18 February. Thank you.</p> <p style="text-align: right; margin-right: 50px;">K. Dyer DCI/IRO</p>
2.				
3.				
4.				
5.				
6. RETURN TO: DCI/IRO, 6E2914 OHB				
7.				
8.				
9.				
10.				
11.				
12.				
13.				
14.				
15.				

ROUTING AND RECORD SHEET

SUBJECT: (Optional)

FROM:
DCI/IRO
6E2914 OHB

EXTENSION

NO.

39058

DATE

13 February 1997

TO: (Officer designation, room number, and building)

DATE

OFFICER'S INITIALS

COMMENTS (Number each comment to show from whom to whom. Draw a line across column after each comment.)

RECEIVED

FORWARDED

1. O/IG - [REDACTED]
2X30 NHB

2/14/97

2. RICK CINQUEGRANA

all 2/14

3. George Clarke

mc 2/18

4. [REDACTED]

2/18

5. KATHY DYER (DCI/IRO)

6. [REDACTED]

7. [REDACTED]

8. [REDACTED]

9. [REDACTED]

10. [REDACTED]

11. [REDACTED]

12. [REDACTED]

13. [REDACTED]

14. [REDACTED]

15. [REDACTED]

Attached are copies of various regulations relating to mission & functions. Please review those portions which relate to your office and/or responsibilities. The Staff of the JFK Assassination Review Board has asked that these be declassified and released. (Some material is AIUO.) Please indicate concurrence in the release of this information. (If object, please bracket sensitive information and provide a written explanation detailing the damage.) Response is needed by COB 18 February. Thank you.

K. Dyer
DCI/IRO

Rick/George,
Please take a look at this & provide comments, if any. There is only one part (at yellow sticky) that I feel should NOT be released.
Jerry

Jerry - See
Portraits 5 -
P. 12 + Computer
Guide -
cover by staff
is UNCLASSIFIED
mc

George } I don't
Jerry } think even
the bracketed
language warrants
classification. Jike

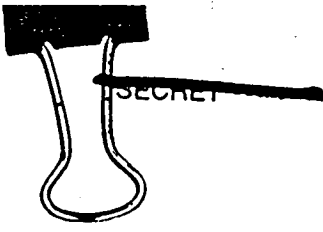

24 February 1997

MEMORANDUM FOR: J. Barry Harrelson
CSI/HRG

FROM: Kathryn I. Dyer
DCVIRO

SUBJECT: ARRB Request No. CIA-1- -Classification
Review

REFERENCE: Your memorandum dated 24 January 1997

1. Reference advised that the staff of the John F. Kennedy Assassination Records Review Board had requested certain organizational information relating to the Agency be declassified. The following information may be released in full:

R-110, 7 December 1959, pages 1-2;
 HR 1-2, 1 April 1961, pages pages 5-6;
 16 August 1963, pages 5-6;
 HR 1-2b 31 March 1964, , page 6;
 HR 1-2 30 December 1965, pages 5-6.

HN 1-6, 29 November 1961;
 HN 1-12, 2 April 1962;
 HN 1-14, 16 April 1962;
 HN 1-55, 28 April 1965.

HR 1-3, 16 August 1963, pages 7-9;
 HR 1-3/4, 31 March 1964, pages 11-12;
 HR 1-3b, 16 December 1966, two copies page 12;
 HR 1-3, 18 February 1969, page 12;
 HR 1-3, 30 May 1975, page 11;
 HR 1-3b, 23 May 1975, page 12.

The remaining document- -HN 1-33, 3 April 1963, may be released as sanitized.

2. This completes action on this matter by DCVIRO. If any questions, please call- -39058 (s).

Kathryn I. Dyer
 Kathryn I. Dyer

Administrative Internal Use
 Only when separated from
 attachments.

~~SECRET~~

CIA HAS NO OBJECTION TO
DECLASSIFICATION AND/OR
RELEASE OF CIA INFORMATION
IN THIS DOCUMENT

DRAFT

Mr. J. Barry Harrelson
April 16, 1997
Page 3

historical understanding of the assassination by providing some background on CIA records.

CIA should now review the DO and DS&T organizational material and re-examine some of the proposed redactions. Several documents have been cleared by the directorate IRO's for either release in full or release with minor redactions.⁴ The ARRB staff will consult with CIA to determine whether these records should be designated "assassination records" or whether they could be made available publicly in a manner similar to the material from the 1996 Boston trip. HRG would like to discuss this issue before the materials are formally put before the Review Board.

CIA-2 through CIA-5.

These requests have been satisfied and no further action is needed by CIA.

⁴These are:

DCI

- Organization of the Office of the Director 1963
- Mission Statements for 1959, 1962, 1965 and 1966
- some Office of the Director notices
- OGC and IG Mission Statements for 1964, 1966, 1969, 1975, and 1976
- OLC Mission Statement for 1975 and 1976

DI

- Organization and Functions of the DI pre-1961
- Organizational Charts for 1961, 1964, and 1969
- Mission Statements for 1961, 1963, 1964, 1966, and 1970

DA

- Mission Statements 1957, 1958, 1960, 1963, and 1974
- Organizational Chart 1958, 1960, 1961, 1962, 1964, and 1966
- Office of Security Organizational Charts for 1956, 1958, 1962, 1963, 1966, 1967, 1969, and 1975
- Office of Security Mission Statements for 1958, 1962, 1963, 1966, 1969, and 1975.

2 February 1998

T. Jeremy Gunn, Esq.
Executive Director
Assassination Records Review Board
600 E Street, N.W. 2nd Floor
Washington, D.C. 20530

Dear Mr. Gunn:

Re: CIA-1 Organizational Material, Request
For Additional Information

This is in response the Board's request for additional information on the organization of the CIA as contained in referent request.

Enclosed are five lists of documents which describe the organization and missions of the CIA's four directorates -- the Directorate of Administration (DA), Directorate of Intelligence (DI), Directorate of Science and Technology (DS&T, and Directorate of Operations (DO) -- as well as a the Office of the Director of Central Intelligence (DCI). All of the documents within each list were selected by the ARRB staff as responsive to this request. The documents identified within the lists can be released in full or sanitized form except for those pertaining to the Directorate of Operations. All documents within the DO list are denied in full.

Following the DO list is an unclassified memorandum which explains the sensitivity of the DO documents and the reasons they must be withheld. In short, their release could compromise intelligence functions and activities.

The released versions of the documents contained within the attached lists will be incorporated into the JFK collection as supplementary materials. If you have any questions in this regard, please advise.

Sincerely,

J. Barry Harrelson

Encl. A/S

DRAFT

ARRB Request CIA-1

The following Office of the Director Central Intelligence (DCI) documents can be Released in Full:

R 1-110	7 December 1959 pp. 1-2	Organization and Function (Mission Statement)
HR 1-2	1 April 1961 pp. 5-6	Mission Statement Office of the Director
HR 1-2	16 August 1963 p. 5	Mission Statement Office of the Director
HR 1-2b	16 August 1963 p. 6	Mission Statement The Deputy Director
HR 1-2b	31 March 1964 p. 6	Mission Statement The Deputy Director
HR 1-2	30 December 1965 p. 5	Mission Statement Office of the Director
HR 1-2b	30 December 1965 p. 6	Mission Statement The Deputy Director
HN 1-6	29 November 1961	Assumption of Office Director, CIA
HN 1-12	2 April 1962	Delegation of Authority
HN 1-14	16 April 1962	Organization - Establishment of the Executive Committee
HN 1-55	28 April 1965	Delegation of Authority
HR 1-3b	16 August 1963 p. 7-9	Mission Statement Independent Offices
HR 1-3	31 March 1964 p. 11	Mission Statement Independent Offices
HR 1-3b	16 December 1966 p. 12	Mission Statement Independent Offices

DRAFT

DRAFT

HR 1-4	31 March 1964 p. 12	Mission Statement Independent Offices
HR 1-3b	16 December 1966 p. 12	Mission Statement Independent Offices
HR 1-3	18 February 1969 p. 11	Mission Statement Independent Offices
HR 1-3b	23 May 1975 p. 12	Mission Statement Independent Offices
HR 1-3	30 May 1975 p. 11	Mission Statement Independent Offices

The following DCI document can be Released as Sanitized:

HN 1-33	3 April 1963 pp. 1-9	Organization of the Office of the Director
---------	-------------------------	--

DRAFT

CJA #1

5

*See
VVI I*

CL BY: 462125
CL REASON: Section 1.5
DECL ON:
DRV FRM:

TO: J. Barry Harrelson @ DCI
FROM: Becky L. Rant
DATE: 02/09/98 11:22:38 AM
OFFICE: DA/IRO
SUBJECT: Re: ARRB Request CIA # 1 - Draft response

Barry: Following up on our telephone conversation regarding ARRB Request CIA #1, the draft letter is fine with me. My comments with respect to the enclosure to the letter follow:

1. I concur with full release of the 16 CIA mission, function and organizational charts insofar as DA equities are concerned. As we discussed, the other Directorates should approve their portions of the charts if they haven't already done so.
2. I concur with the full release of the 31 mission statements and organization charts for the DDA (DDS) and the Office of Security.
3. I concur with the release as sanitized of the 2 organization chart and mission statement of the Office of Communications.

Also, in accordance with AR 70-5, f(18), dated 6/30/97, release of Agency regulations must be approved by the D/OIM

Please call if you have any questions.
Original Text of J. Barry Harrelson
Original Text of J. Barry Harrelson

This afternoon you will receive under separate cover (fax or hand-carried) a draft response to ARRB request CIA # 1 and a list of documents subject to the request. Please review; if you have any comments or questions please contact me no later than cob Tuesday, 3 Feb. For those you who are new to JFK, this request date back to March 1995. The documents on the lists were selected by the ARRB and reviewed for declassification and release by the Directorate IROs and appropriate components. Our official response is due the ARRB this week.

CC:

7 April 1998

MEMORANDUM FOR: (U) Chief, Historical Review Program/OIM/DA

FROM: (U) Fredrick C. Wickham, Jr.
Chief External Support Group/IMS/DOP

SUBJECT: (U) DO Response to Formal Request CIA #1

REFERENCE: (U) Informal meeting of 27 February 1998, with Jeremy Gunn, Michelle Combs, Barry Harrelson, Gary Breneman and Eileen Wukitch regarding a request for additional information relating to CIA #1

1. (U) In response to a request from Jeremy Gunn and Michelle Combs, attached are two organizational charts showing the structure of the Deputy Director for Plans (DDP) in 1961 and 1963. As noted, CIA has released the DDP structure down to the division/staff level; however, we continue to protect the release of the structure to the branch/desk level. The data used in recreating these charts were extracted from an official classified history of CIA.

2. (U) Regarding the request for an organizational chart of the JMWAVE facility in the 1960-1963 time frame, after thorough review and due consideration, the Agency continues to protect this information on the reasons stated in our original response.



Fredrick C. Wickham, Jr.

Attachments as stated:

UNCLASSIFIED

SUBJECT: DO Response to Formal Request CIA #1

IMS/ESG DennyR.Hess:mjk (7 April 1998)

Distribution:

Orig & 1 - Addressee
1 - C/IMS/ESG
1 - C/IMS/ESG/HCS
1 - IMS/ESG Chrono

UNCLASSIFIED

DEPUTY DIRECTOR FOR PLANS - 1961

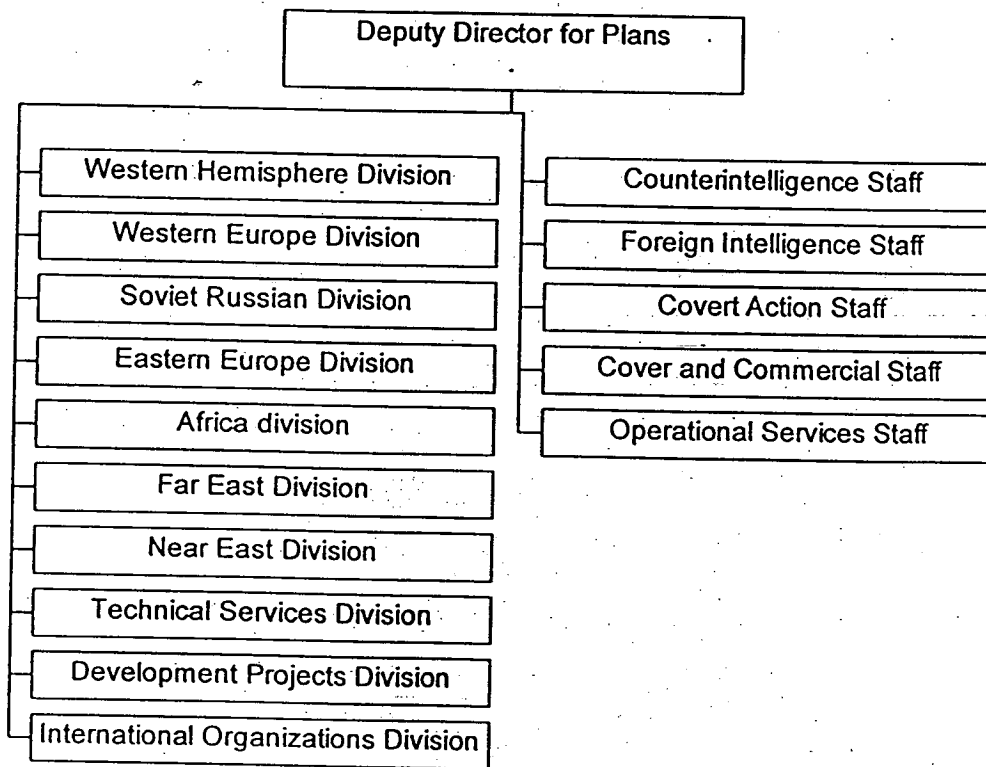

DEPUTY DIRECTOR FOR PLANS - 1963

