

This document is made available through the declassification efforts
and research of John Greenewald, Jr., creator of:

The Black Vault



The Black Vault is the largest online Freedom of Information Act (FOIA) document clearinghouse in the world. The research efforts here are responsible for the declassification of hundreds of thousands of pages released by the U.S. Government & Military.

Discover the Truth at: <http://www.theblackvault.com>

BENADUM, Jeremy K.

Munro, George Frederick
coming. call Shep
(1542) when it
arrives. (78-0433/
OLC
6 Mar 78
Memo

Date

FORM 5-75 101 USE PREVIOUS EDITIONS

SECRET - SECURITY INFORMATION

CONTRACT PERSONNEL

OFFICE OF PERSONNEL
RETURN FILE TO 5E69

NOTICE: This is an Office of Personnel File and subject to 10 day limitation period. This file has been charged to pat and is due to be returned to CONTRACT PERSONNEL DIVISION, 5E-69 Hqs., x7841, as of _____.

Vertical stamp: 31 Dec 1971

302858

302858

NOTIFICATION OF PERSONNEL ACTION								
1. SERIAL NUMBER		2. NAME (LAST, FIRST, MIDDLE)			3. NATURE OF PERSONNEL ACTION			4. EFFECTIVE DATE
002177		HERBOLD, JEREMY K			CONTRACT TERMINATION (CFJGD)			12/31/70
					5. CATEGORIES OF EMPLOYMENT			6. PREPARED BY
					CAREER AGENT (S)			AR/EN/US
6. FUNDS		7. FINANCIAL AGENCY NO. (MANDATORY)		8. CSC OR OTHER LEGAL AUTHORITY		9. ORGANIZATIONAL DESIGNATIONS		
V TO V CF TO V		V TO CF CF TO CF		1135-014		CCP DIRECTORATE WESTERN HEMISPHERE DIV LITMPC		
						10. LOCATION OF OFFICE STATION		
						UNDETERMINED		
11. POSITION TITLE				12. POSITION NUMBER		13. CAREER SERVICE DESIGNATION		
OPS OFFICER								
14. CLASSIFICATION SCHEDULE (GS, LS, etc.)		15. OCCUPATIONAL SERIES		16. GRADE AND STEP		17. SALARY GR. RATE		
(FULL TIME) GS		0-30.01		15 7		CCG: 103050 LEI: 041970		
18. REMARKS								
<p>----- STATUS INFORMATION -----</p> <p>BIRTH DATE: 5 SEX: M MARITAL ST: MAR NO. DEPENDENTS: 07 CITIZENSHIP: US/BIRTH LONGEVITY COMP: 103050 FED SERVICE COMP: 110735 TYPE RETIREMENT: CIA N-D HOSPITALIZATION: F PLAN: 422 FGLI: YES/CFT PREV. GOVT SERV: 1 SAL. TASK LIMIT: PAY BASIS: A A/L IND: 5 S/L INC: 4</p> <p>----- CONTRACT INFORMATION -----</p> <p>EFF DATE: 092567 EXPIRATION DATE: INCEFN DATE ORIG CONTRACT: 103050 REFERRING OFFICER: WH-PERS FEFF ORG: WH FECAF: 4460</p> <p>----- ENTITLEMENTS/ELIGIBILITIES/ALLOWANCES -----</p> <p>TAX STAFF: Y FED EXMP: STATE EXMP: STATE: TRAVEL: NFN LPS EXPNSE: Y HOUSING: 4 POST/EQUAL: HOME LEAVE: 4 DIFFERENTIAL: N OFFSET CLAUSE: Y STD GOVT: Y LEGISL PAY: Y PREMIUM PAY: N ALLOWANCE COMP: N EDUCATION: STPP INCS: Y OTH TAX ENTL: N OTHER ALLOWNS: N SEPARATION:</p>								
NOTE: ITEMS PRECEDED BY AN ASTERISK * REFLECT CHANGED DATA								
SIGNATURE OF OTHER AUTHENTICATION								

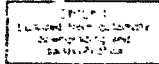

NOTIFICATION OF PERSONNEL ACTION

1. SERIAL NUMBER 0225773		2. NAME (LAST FIRST MIDDLE) D. MADAM JEREMY K		3. NATURE OF PERSONNEL ACTION MISCELLANEOUS CHANGE		4. EFFECTIVE DATE 19 01 75		5. CATEGORY OF EMPLOYMENT CAREER AGENT (S)		
6. FUNDS		V TO V	F TO F	7. FINANCIAL BASIS (NO. TRAPGABLE)		8. CSC OR OTHER LEGAL AUTHORITY				
9. ORGANIZATIONAL DESIGNATIONS DDP DIRECTORATE WESTERN HEMISPHERE DIV LITEMPO		10. LOCATION OF OFFICIAL STATION UNDETERMINED		11. POSITION TITLE OPS OFFICER		12. POSITION NUMBER		13. CAREER SERVICE DESIGNATION		
14. CLASSIFICATION SCHEDULE (GS, FS, etc.) (FULL TIME) GS		15. OCCUPATIONAL CLASS G136.01		16. GRADE AND STEP 15 7		17. SALARY OR RATE DDG: 18360 LEL: 34197				
18. REMARKS										
<p>----- STATUS INFORMATION -----</p> <p>BIRTH DATE: 15 SEX: M MARITAL ST: MAR NO. DEPENDENTS: 07 CITIZENSHIP: US/BIRTH LONGEVITY COMP: 103060 FED SERVICE COMP: 11759 TYPE RETIREMENT: CIA R-C HOSPITALIZATION: F PLANS: 422 FEGLI: YES/OPIN PREV. GOVT SERV: 1 SAL. TASK LIMIT: PAY BASIS: A A/L IND: 3 S/L IND: 4</p> <p>----- CONTRACT INFORMATION -----</p> <p>EFF DATE: 092567 EXPIRATION DATE: INDEPN DATE ORIG CONTRACT: 103060 REFERRING OFFICER: WH-PERS REFR ORG: WH PHONE: 4460</p> <p>----- ENTITLEMENTS/ELIGIBILITIES/ALLOWANCES -----</p> <p>TAX STAFF: Y FED EXMP: STATE EXMP: STATE: TRAVEL: NHM OPS EXPASE: Y HOUSING: A POST/EQUAL: HOME LEAVE: 4 DIFFERENTIAL: N OFFSET CLAUSE: Y STD GOVT: Y LEGISL PAY: Y PREMIUM PAY: N ALLOWANCE COMM: N EDUCATION: STEP INCRS: Y OTH TAX ENTL: N OTHER ALLOWNS: N SEPARATION:</p>										
NOTE: ITEMS PRECEDED BY AN ASTERISK * REFLECT CHANGED DATA										
SIGNATURE OF OTHER AUTHENTICATION										

NOTIFICATION OF PERSONNEL ACTION

1. CONTROL NUMBER		2. NAME (LAST, FIRST, MIDDLE)		3. EFFECTIVE DATE		4. CATEGORY OF EMPLOYMENT	
0222774		RENAECLA J. JELLY S		11/11/71		CAREER AGENT (SI)	
5. NATURE OF PERSONNEL ACTION				6. FINANCIAL ANALYSIS AND CHANGE/CLASS			
LEGISLATIVE PAY ADJUSTMENT				7. CODE OF OTHER LEGAL AUTHORITY			
8. FUNDS		9. Y TO V		10. Y TO O		11. Y TO U	
▶							
12. FUNCTIONAL DESIGNATION				13. LOCATION OF DUTY STATION			
COP DIRECTORATE WESTERN HEMISPHERE DIV LITMPC				UNDETERMINED			
14. ROSTER TITLE		15. POSITION NUMBER		16. CAREER SERVICE DESIGNATION			
CPS OFFICER							
17. CLASSIFICATION SCHEDULE (GS, FS, etc.)		18. INCENTIVE STEPS		19. GRADE AND STEP		20. SALARY OR RATE	
(FULL TIME) GS		1336.01		15 7		DBG: 10306 BP: 25055 LBI: 14157	
21. STATUS INFORMATION							
BIRTH DATE: 15 SEX: M MARITAL ST: MAR NO. DEPENDENTS: 07							
CITIZENSHIP: US/BIRTH LONGEVITY COMP: 10/180 FED SERVICE COMP: 11/739							
TYPE RETIREMENT: CIA R-C FUSPITALIZATION: F PLAN: 422							
FGLI: YES/CPTA PREV. GOVT SERV: 1 SAL. TASK LIMIT:							
PAY BASIS: A A/L IND: B S/L INC: 4							
22. CONTRACT INFORMATION							
EFF DATE: 022567 EXPIRATION DATE: INDEFN DATE ORIG CONTRACT: 103060							
REFERRING OFFICER: WF-PERS HOFF ORG: DM PHONE: 4460							
23. ENTITLEMENTS/ELIGIBILITIES/ALLOWANCES							
TAX STAFF: Y PRO. EXPF: STATE EXPF: STATE:							
TRAVEL: NHN CPS EXPNSE: Y HOUSING: A FOST/BCUAL:							
HOME LEAVE: 4 DIFFERENTIAL: N OFFSET CLAUSE: Y STD GOVT: Y							
LEGISL PAY: Y PREMILA PAY: N ALLOWANCE COMP: A EDUCATION:							
STEP INCS: Y CTR TAX ENTL: N OTHER ALLOWNS: N SEPARATION:							
NOTES: ITEMS PRECEDED BY AN ASTERICK * REFLECT CHANGED DATA							
SIGNATURE OF OTHER AUTHORITY:							

Mexico, D.F.

31 July, 1970

To: COB
From: Jorcmay K. Bonadum
Subj.: Military Service

Upon graduation from Pomona College, Claremont, California, in June, 1936, writer was commissioned as 2nd Lt. of Infantry. On October 25, 1939, writer went on active duty under the Thomson Act, being assigned to duty with the 30th U.S. Infantry, with headquarters at the Presidio, San Francisco, California. He remained on active duty until 30 July, 1940, at which time he reverted to reserve status. Writer remained in this status, with the rank of 1st Lt. until 1942, at which time all reserve officers in the FBI were requested to resign their commissions. The latter was done under an arrangement between the Defense Dept. and the FBI. Writer has never received a discharge, so is unable to produce same.

1. PERSONAL SERIAL NO.		BIOGRAPHIC PROFILE (PART I) 7 Nov 1970	
2. NAME (Last-First-Middle) KEMMIGER, Joseph V. (M)		3. DATE OF BIRTH (MM/DD/YYYY) 30 Oct 1940	
4. MARITAL STATUS Married	5. DEPENDENTS 7	6. PLACE OF BIRTH Tomb, 1940	7. US CITIZENSHIP DATE 2
8. CAREER STATUS MEMBER	9. OTHER STATUS Tomb, 1940	10. EDUCATION Tomb, 1940	11. EMPLOYMENT Tomb, 1940
12. RESERVE STATUS Y	13. PROFESSIONAL TEST DATE	14. LANGUAGE ABILITY TEST DATE	
15. NON-CIA EMPLOYMENT 1932-40 1944 Dept. Commerce, US (2 yrs) 1940-60 Dept of Justice, FBI			
16. NON-CIA EDUCATION 2-36 Pomona College, Claremont, Calif (Graduate) - ?			
17. FOREIGN LANGUAGE ABILITIES (Language, Proficiency, Date Tested)	18. AGENCY SPONSORED TRAINING		
19. CIA EMPLOYMENT HISTORY SINCE 10 SEP 1949 (Personnel Actions, Military Orders, and Principal Details)			
EFFECTIVE DATE	POSITION TITLE & OCCUPATIONAL CATEGORY	ORGANIZATION & AGENCY TITLE (If any)	LOCATION
Oct 1970	CR Cdn Off (Career Agt)	27, 157 15/7-30v DLP/RR/MT330	Mexico City
Apr 1966	" " " " " "	27, 157 15/7-30v " " "	" "
Apr 1970	" " " " " "	27, 157 15/7-30v " " "	" "
Sep 1970	Ops Of (Career Agt)	CL36.01 27, 157 15/7-30v " " "	" "
20. DATE REVIEWED 9 Dec 1970	21. PROFILE REVIEWED BY bc/cls	22. STATUS (10 REVIEWED) VERIFIED BY EMPLOYEE	

SECRET
(When Filled In)

REFS. SERIAL NO.	BIOGRAPHIC PROFILE (PART 2)	
	(P)	DATE OF BIRTH
<p>in Official Personnel Folder. Subject's EOD date as CA is Oct. 1962. No info Available.</p>		
<p>REFERENCE OUTLINE AND/OR FIELD REASSIGNMENT QUESTIONNAIRE</p>		
<p>ADDITIONAL COMMENTS WHICH SHOULD BE REVIEWED IN DETAIL</p>		
<p>ADDITIONAL INFORMATION</p>		
	<p>18. PROFILE REVIEWED BY [Signature]</p>	

SERVICE COMPUTATION DATE - Jeremy K. BENADON (P)

Service	From	To	Total Creditable Time		
			Years	Months	Days
Active duty in U.S. Army	26 Oct 39	31 Jul 40	-	9	5
Federal Bureau of Investigation	12 Aug 40	31 Oct 60	-	-	-
CIA Career Agent	30 Oct 60	date	-	-	-

Gain: 12 Aug 1940 as a base date less above total creditable time
 equals a SCD of: 7 November 1939.

Paul Wilson
 10 Jun 1969

May 5, 1971

Wells Fargo Bank
404 California Street
San Francisco, California 94104

Gentlemen:

Enclosed is Union Trust Company Treasurer's Check number
Q1-356154, dated April 27, 1971, payable to Mr. George Frederick
Munro, in the amount of \$43.00. Please deposit the enclosed
check to Mr. Munro's account number

Sincerely,

Enclosure

Airmail, Certified.

SECRET (When Filled In)

Date 4-19-71

TO : Administrative Officer/WH
FROM : Chief, Insurance Branch, BSD/Pers
SUBJECT : Refund on Cancelled Insurance Policies ERNADUM, Jeremy K.
(NAME SUBSCRIBER)

Insurance Acct. No. 15574

1. According to the records in this office, subject employee is due a refund of prepaid premiums on his cancelled insurance policies listed below:

<input type="checkbox"/> Contract Health Insurance	\$	_____
<input checked="" type="checkbox"/> Contract Life Insurance	\$	<u>48.00</u>
<input type="checkbox"/> United Benefit Life Insurance	\$	_____
<input type="checkbox"/> WAEPA Life Insurance	\$	_____
<input type="checkbox"/> Flight and Accident Insurance	\$	_____

2. Please notify this office (in writing) how to issue this refund. If we draw our check, it will be under the name of Government Employees Health Association, Inc. If applicable, please submit true name under separate cover for issuance of sterile check.

APC (2/2/71)

Please obtain sterile check and

approval to W.S. Beachman to issue for Treasury

3. If we do not hear from your office by 5-19-71 this money will be posted to Accounts Payable on our ledger and no further effort will be made by this office to contact subject employee.

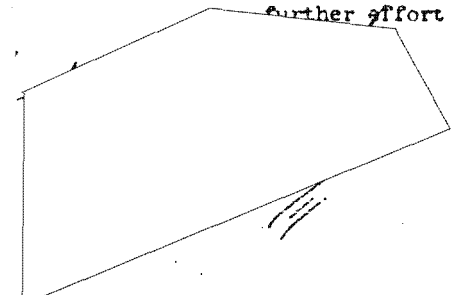

H. O. Brunzhorst
H. O. Brunzhorst

Group 1
Excluded from Automatic
Downgrading and Declassi-
fication.

SECRET (When Filled In)

CLEARANCE SHEET FOR TERMINATION

THIS FORM MUST BE STAMPED BY

20 March 1971

NAME (Last, First, Middle - Give of pseudonym) **James W. (P)** OFFICE AND BRANCH OF ASSIGNMENT
 LOCAL ADDRESS RESIDENT ADDRESS
 San Diego, California
 POSITION OR FUNCTIONAL TITLE
Contract Agent

DATE CONTRACT EFFECTIVE **30 October 1960** DATE CONTRACT LAST RENEWED **30** DATE CONTRACT EXPIRES **30 October** DATE OF CONTRACT TERMINATION **31 December 1970**

REASON FOR CONTRACT TERMINATION
Retirement

INTERNAL STAFF CS DATE OF CLEARANCE (All or None as applicable)

COMPONENT	CLEARED BY	DATE	REMARKS
FINANCE		2/2/71	
LOGISTICS		2/2/71	
PERSONNEL			
Security		2/2/71	

CONTRACT APPROVING OFFICER DATE **2/2/71**

SCHEDULE OF INTERVIEWING OFFICES
(OFFICES NOT INCLUDING INTERVIEW SHALL SO INDICATE)

OFFICE	SERVICE			INTERVIEWING OFFICIAL
	DATE	TIME	LOCATION	
CENTRAL COVER STAFF	22 December 1970			71
OFFICE OF SECURITY PSD	22 December 1970			
OFFICE OF PERSONNEL CPO	22 December 1970			

REMARKS (Please include)
Advances copy to CI/CCO/SIA.

SECRET

OPTIONAL FORM NO. 10
MAY 1962 EDITION
GSA GEN. REG. NO. 27
UNITED STATES GOVERNMENT

Memorandum

TO : OP/Retirement Office
ATTN:
FROM : C/WH/Contracts

DATE: 15 March 1971

SUBJECT: Jeremy K. BENADUM, Retirement

1. Per our telecon this morning, I have sent over to you a copy of the cable from (IN 266625) which stated BENADUM had elected not to make the payment as described in our outgoing cable which your office coordinated with on Friday.

2. It is understood that necessary papers will be forwarded from your office to Miss in the Office of Finance today. I have called Miss and she advised that upon receipt of the papers from you there would be no difficulty in insuring that BENADUM's actual annuity is computed including the retroactive portion for January and February and included in the check for March.

Wm. Ranehan

SECRET

This is a Security Related Document on the Basis of National Defense Information

NO. OF COPIES
TOTAL COPIES

SECRET

BY		DATE	
1		5	
2		6	
3		7	
4		8	

ORIG:
UNIT:
EXT:
DATE:

CABLE SECRETARIAT DISSEMINATION

INDEX NO INDEX RETURN TO _____ BRANCH FILE RID

BY _____ PER _____

FILE IN CS FILE NO. _____

COORD:

1
1
1
1
1

FILE. VR.

SECRET

(date)
(reference number)

CITE DIRECTOR

119594

TO

PAGE TWO (2)

D. PLEASE ADVISE BENADUM'S DECISION. IF ELECTS MAKE PAYMENT, HIS CHECK PAYABLE TO TREASURER OF U.S. SHOULD BE FORWARDED HQS SOONEST.

2. ON RECEIPT OF DECISION AND, IF APPROPRIATE, PAYMENT FOR THE SERVICE, FINAL ANNUITY COMPUTATIONS WILL BE MADE. ANNUITY CHECK FOR MARCH WOULD INCLUDE RETROACTIVE AMOUNT DUE BENADUM FOR JANUARY AND FEBRUARY.

END OF MESSAGE

WH COMMENTS: Advised full retirement annuity could not be paid pending receipt of verification of military service and billing for non-deduction civilian service between 1 Jun 42 and 1 Mar 43.

COORD: C/P/Retirement - [redacted] (in draft)

2 C/R/1 [redacted]

C/L/PIA [redacted]

[redacted]

C/3/D

[redacted]

C/3/CONTRACTS

NO. OF COPIES

SECRET

ADMINISTRATIVE

RE. FILE NO. OFFICER

COPIES

CABLE SECRETARIAT DESIGNATION CLASSIFIED MESSAGE TOTAL COPIES 15-1 ROUTING AND/OR INITIALS SEEN BY

ADVANCE COPY <input type="checkbox"/> INDEXED <input type="checkbox"/> NOTED <input type="checkbox"/>	SECRET (When Filled In)	1	5
	REPRODUCTION OF THIS COPY PROHIBITED	2	6
		3	7
		4	8

MAR 13 2 44 PM '71

ACTION COPY

BY: AT 3

DISSEM BY: PFR

ACTION UNIT: FILE, VR OP2

1113

SECRET 131727Z MAR 71 CITE 15858 13MAR IN286625

DIRECTOR

ADMIN CONTRACTS

REF: DIRECTOR 112594

15 MAR 1971

1. HEREMY K. BENADUM HAS SELECTED NOT RPT NOT MAKE
 PAYMENT AS PER REF PARA 1B. HAS BEEN ADVISED HIS ESTIMATE
 ANNUITY REDUCED TO \$1,194 PER MONTH.

2. FILE DEFER. GP-1

SECRET

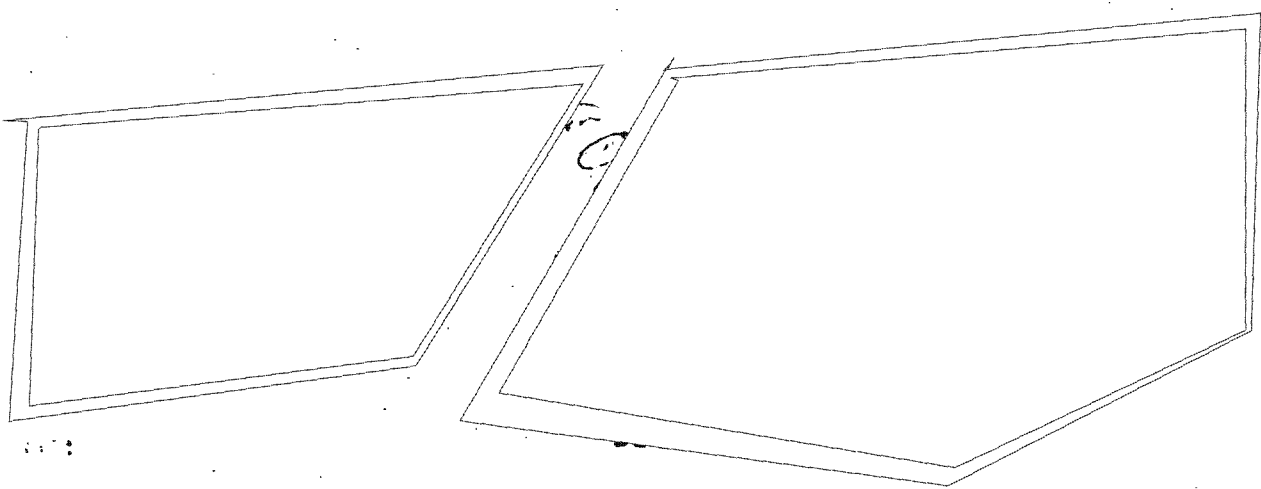

MESSAGE FORM
TOTAL COPIES

ROUTING AND OF INITIALS - CHECK BY

SECRET

1	5
2	6
3	7
4	8

FROM: WSRenehan
TO: WII/Contracts
DATE: 4460
DATE: 12 March 1971

CABLE SECRETARIAT DISSEMINATION

INDEX NO INDEX RETURN TO _____ BRANCH FILE RID
 FILE IN CS FILE NO. _____

BY: 48 PER

COMM: WHS | N | G | FILE VR. *OPD*

(classification) (date and time filed) (folio) (reference number) (pics)

SECRET

221 562 117

CITE DIRECTOR

119534 7

119594

ADMIN CONTRACTS

REF: HNS-7143

1. PLEASE INFORM JEREMY K. BENADUM FOLLOWING.

A. HIS ACTIVE MILITARY DUTY VERIFIED AS 1 JULY 1937 THROUGH 14 JULY 1937 AND 1 DECEMBER 1939 THROUGH 30 JUNE 1940. THIS TOTALS ONE AND ONE-HALF MONTHS LESS THAN BENADUM CLAIMED.

B. VERIFICATION: CIVILIAN SERVICE SHOWS NO RETIREMENT DEDUCTIONS FOR PERIOD 1 JUNE 1942 THRU 28 FEBRUARY 1943. AMOUNT OF \$337 REQUIRED TO PURCHASE CREDIT FOR THIS PERIOD. IF NOT PAID, BASIC ANNUITY WILL BE REDUCED BY 10 PERCENT OF AMOUNT OWED.

C. ANNUITY ESTIMATES RECOMPUTED ON BASIS CHANGE IN CREDITABLE MILITARY SERVICE AND EFFECT OF PAYMENT OR NON-PAYMENT FOR UNCOVERED PERIOD OF CIVILIAN SERVICE. IF PAID, ANNUITY ESTIMATED TO BE \$1,195 PER MONTH. IF NOT PAID, ESTIMATE ANNUITY REDUCTION TO \$1,194 PER MONTH. SHOULD REALIZE WOULD TAKE OVER TEN YEARS TO REGAIN AMOUNT OF PAYMENT.

(CONTINUED)

5
4
3
2
1

5
4
3
2
1

RELEASING OFFICER

COORDINATING OFFICERS
SECRET

AUTHENTICATING OFFICER

REPRODUCTION BY OTHER THAN THE ISSUING OFFICE IS PROHIBITED.

FORM NO

MESSAGE FORM
TOTAL COPIES:

SECRET

POSTING AND/OR INITIALS		
1		
2		
3		
4		

ORIG:
UNIT:
EXT:
DATE:

CABLE SECRETARIAT DISSEMINATION

INDEX NO INDEX RETURN TO _____ BRANCH FILE RID

BY _____ PER _____

FILE IN CS FILE NO. _____

CONF:

IN
C

FILE NR.

(classification)
SECRET

(date and time filed)

(date) (pics)
(reference number)

CITE DIRECTOR

119594

TO

PAGE TWO (2)

D. PLEASE ADVISE BENADUM'S DECISION. IF ELECTS MAKE PAYMENT, HIS CHECK PAYABLE TO TREASURER OF U.S. SHOULD BE FORWARDED HQS SOONEST.

2. ON RECEIPT OF DECISION AND, IF APPROPRIATE, PAYMENT FOR THE SERVICE, FINAL SECURITY COMPUTATIONS WILL BE MADE. ANNUITY CHECK FOR MARCH WOULD INCLUDE RETROACTIVE AMOUNT DUE BENADUM FOR JANUARY AND FEBRUARY.

END OF MESSAGE

WH COMMENTS: Advised full retirement annuity could not be paid pending receipt of verification of military service and billing for non-deduction civilian service between 1 Jun 42 and 1 Mar 43.

COORD: CP/Retirement - [redacted] (in draft)

C/WH/1 [redacted]

C/WH/PI [redacted]

5
3
2
1
WILLIAM V. BRICE
C/WH

5
4
3
2
1
WILLIAM S. FENWICK
C/WH/COMMENTS

COORDINATING OFFICERS

RELEASING OFFICER

SECRET

AUTHENTICATING OFFICER

REPRODUCTION BY OTHER THAN THE ISSUING OFFICE IS PROHIBITED.

COPY NO.

ROUGH DRAFT

10 March 1971

1. Please advise Jeremy K. BENADUM that the appropriate military authority has verified the following dates of active duty:

1 July 1937 through 14 July 1937
1 December 1939 through 30 June 1940

This service totals one and one-half months less than that claimed by BENADUM.

2. Records verifying BENADUM's civilian service show that during period 1 June 1942 through 28 February 1943 retirement deductions were not withheld from salary. The amount of \$307.00 will be required to purchase credit for this period. If not paid, Subject's annuity will be reduced by 10 per cent of the amount owed or \$31.00 per year. If Subject elects to make payment, his check should be made payable to the Treasurer of the United States and forwarded to Headquarters soonest.

3. Annuity estimates recomputed to reflect change in creditable military service and effect of payment or non-payment for uncovered period of civilian service. If paid, annuity will be \$1,196 per month. If not paid, annuity reduced to \$1,194.

4. Advise Headquarters BENADUM's election on payment vs non-payment option.

ORIG: WSRenehan:md
UNIT: WH/Contracts
EXT: 4460
DATE: 17 February 1971

TOTAL COPIES 12
SECRET

1	2
3	6
4	7
5	8

CABLE SECRETARIAT DISSEMINATION INDEX NO INDEX RETURN TO _____ BRANCH FILE RID
BY: 28 PER _____ FILE IN CS FILE NO. _____

CONF: 478 FILE NO. 662 FILE YR. _____
(classification) (date and time filed) (folio) (reference number) (page)

SECRET

18 21 30z FEB 71

CITE DIRECTOR 112046

TO

[Redacted]

ADMIN CONTRACTS

REFS: A. [Redacted] 5618 (IN 266892)

B. HMMS-7143, DTD 17 FEB.

PLEASE SEE REF B.

22 FEB 1971

END OF MESSAGE

WH COMMENTS: A. BENADUM requests Hqs identify deposit of \$950.
B. Jeremy K. BENADUM, Retirement Annuity.

COORD: C/WH/1 [Redacted]

WH/FI/ [Redacted]

[Redacted]
WILLIAM V. BROE
C/WH/D

[Redacted]
WILLIAM S. RENEHAN
C/WH/CONTRACTS

RELEASING OFFICER

COORDINATING OFFICERS

SECRET

GROUP 1
Excluded from automatic
downgrading and
declassification

AUTHENTICATING OFFICER

REPRODUCTION BY OTHER THAN THE ISSUING OFFICE IS PROHIBITED.

COPY NO.

TO: Chief of Station, [redacted]

NO. [redacted]
NO. [redacted]
NO. [redacted]

FROM: Chief, WH Division
ADMIN/CONTRACTS
Jeremy K. BENADUM, Retirement Annuity

ACTION REQUIRED REFERENCES

1. The Retirement Office has advised that Jeremy K. BENADUM's annuity check for January will be an interim payment representing about 75% of basic annuity.
2. The full annuity could not be paid pending receipt of verification of military service and billing for non-deduction civilian service between 1 June 1942 and 1 March 1943. Headquarters has been checking with the Retirement Office on a continuous basis but as yet the information has not been received. Upon receipt of the required info, you will be promptly advised.
3. Please assure BENADUM that he will receive retroactive payment in a subsequent check for full entitlement.

Norman R. PATERSILL

Distribution: 2-COS, [redacted]

CROSS REFERENCE TO	DISPATCH SYMBOL AND NUMBER	DATE
	HMS-7143	
	CLASSIFICATION	HQS FILE NUMBER
	SECRET	
1-WH/PI [redacted] 1-WH/1 1-WH/Registry 1-WH/Contracts	ORIGINATING OFFICE	DATE
	WH/Contracts	me (11 Feb 71)
	COORDINATING OFFICE	DATE
	C/WH/PI [redacted]	12 Feb 71
	C/WH/1	12-1-71
OFFICIAL SIGNATURE	DATE	OFFICIAL NUMBER
C/WH/SS	16 Feb 71	Richard B. Wright

DISPATCH

1. SECRETARIAT DISSEMINATION

CLASSIFIED MESSAGE

TOTAL COPIES 3

PRINTING AND/OR INITIALS SEEN

SECRET

(When Filled In)

1	5
2	6
3	7
4	8

35

ADVANCE COPY ISSUED SLOTTED

PERFORMING OFFICE OF THE SECRETARY OF DEFENSE

FEB 12 10 29 AM '71
ACTION COPY

CLASSIFIED BY 23
REASON FOR

FILE, VR

OF 2

315

SECRET 162254Z FEB 71 CITE

5616

16 FEB 1971

DIRECTOR

ADMIN FINANCE

17 FEB 1971

REF: WMS-6919 DTD 22 JULY 72

1. JEREMY K. BENADUM REPORTS RECEIPT OF BANK DEPOSIT NOTICE COVERING GOVERNMENT CHECK IN AMOUNT \$952.00. ONLY LARGE DEPOSIT BENADUM ANTICIPATED AT PRESENT TIME IS FIRST RETIREMENT ANNUITY CHECK.

2. REF INDICATED ESTIMATE FOR BENADUM ANNUITY \$1,202 PER MONTH, WHICH HARD TO RECONCILE WITH \$950 DEPOSIT. FACT THAT DEPOSIT FOR SUCH EVEN AMOUNT ALSO INDICATES IT MAY NOT BE FIRST ANNUITY PAYMENT.

3. BENADUM REQUESTS HEADQUARTERS IDENTIFY DEPOSIT IF POSSIBLE, AND PROVIDE EARNINGS AND DEDUCTIONS BREAKDOWN IF APPROPRIATE. BENADUM ALSO REQUESTS GROSS-DEDUCTIONS - NET BREAKDOWN OF ANNUITY PAYMENTS. GP-1

SECRET

Handwritten signature and date: 17 Feb 71

SECRET

24 Jan 71

MEMORANDUM FOR THE RECORD

SUBJECT: Jeremy K. BENADUM, Payment of Annuliy

REF: DIRECTOR 104776

1. At the time of transmittal of Reference, I had been informed that the military service still had not been verified. In talking about this matter with Mr. [redacted] I asked if he would request MMPD, possibly through some ~~sargeant~~ sargeant to sargeant or colonel to colonel whether the matter could be expedited. He assured me he would give this an all-out try and agreed to let me know during the forthcoming week.

2. In checking this morning I find that Mr. [redacted] is out on leave and going into training for at least the next week. In asking how to get in touch with Mr. [redacted] eventually Mrs. [redacted] came on the line. She advised that nothing new was in the record and there was no info on the verification of the military service and wished to assure me that just because someone want on leave or was out that a case was not dropped. I asked then if any effort has been made to contact MMPD. She said the file didn't reflect anything and agreed to check MMPD and let me know.

*File
by [redacted] on [redacted]
verification of [redacted]*

TO: WFO/Contracts
DATE: 22 Jan 71

MESSAGE FORM
TOTAL COPIES: 15-3

S E C R E T

REVIEWING OFFICER'S INITIALS		FILED BY	
1		5	
2		6	
3		7	
4		8	

CABLE SECRETARIAT DISSEMINATION INDEX NO INDEX RETURN TO _____ BRANCH FILE RID
 BY: 36 PER: _____ FILE IN CS FILE NO. _____

CONF: W/18 FILE VR. OP2, OF2, CCS2, CSP3

(classification) (date and time filed) (title) (reference number) (pics)

S E C R E T

CITE DIRECTOR 104776

23 JAN 71 09 19Z

[Redacted]

ALAIN CONTRACTS

REF: [Redacted] 5381 (IN 248431)

25 JAN 1971

FOLLOWING KEYED REF

1. ALTHOUGH ACTUAL REQUIREMENTS MAY VARY AMONG INDIVIDUAL BANKS, SUGGEST JEREMY K. BENADUM ADVISE BANK THEY WILL BE RECEIVING GOVERNMENT SECURITY CHECKS FOR DEPOSIT HIS ACCOUNT AND INCLUDE POWER OF ATTORNEY IN LETTER.

2. NO CARD OR OTHER EVIDENCE OF RETIREMENT PROVIDED. LENGTH OF SERVICE (32 YEARS 2 MONTHS INCLUDES SICK LEAVE) CITED HENS 6919. INSURANCE CARD NOT ISSUED RETIREES ABROAD AS HOSPITALS WOULD NOT ACCEPT. SEE HENS 7107 FOR INSTRUCTIONS ON FORWARDING HOSPITALIZATION CLAIMS. WILL BE PROVIDED SECURITY STATEMENT WHICH WILL INCLUDE AMOUNT OF RETIREMENT CONTRIBUTIONS FOR INCOME TAX PURPOSES.

A. STATION AUTHORIZED PAY FOLLOWING FIELD ALLOTMENT FOR PERIOD 13 - 31 DECEMBER AND T/A HQS.

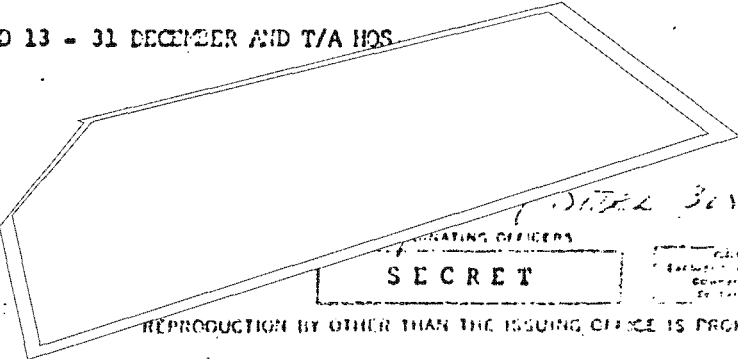

ISSUING OFFICERS

S E C R E T

GROUP 1
Excluded from automatic
downgrading and
declassification

AUTHENTICATING OFFICER

REPRODUCTION BY OTHER THAN THE ISSUING OFFICE IS PROHIBITED.

COPY NO.

RECEIPT FORM
IN THE OFFICE

SECRET

RECEIVED		DATE		BY	
1					
2					
3					
4					

ORIG:
UNIT:
EXT:
DATE:

CABLE SECRETARIAT DISSEMINATION

INDEX NO INDEX RETURN TO _____ BRANCH FILE RID

BY _____ PER _____

FILE BY CS FILE NO. _____

CONF:

FILE, VR.

(classification)

(date and time filed)

(initials)

(pic)

CITE DIRECTOR

PAGE TWO (2)

71047767

to

GROSS \$1,478.40

DEDUCTIONS:

FEGLI 12.38

OPTIONAL FEGLI 8.25

HOSPITALIZATION 14.09

RETIREMENT 103.49

INCOME TAX 191.55

1970 TAX ADJUSTMENT 147.00

476.76

\$1,001.64

REFUND OF TAX OVER WITHHELD
PAY PERIODS 11, 12 AND 13

121.50

NET

\$1,123.14

NOTE: CONTRACT LIFE INSURANCE COVERAGE CEASED 31 DECEMBER. WILL REFUND
PREPAID PREMIUMS.

(CONTINUED)

COORDINATING OFFICERS

RELEASING OFFICER

SECRET

RECEIVED
DATE
TIME

AUTHENTICATING
OFFICER

REPRODUCTION BY OTHER THAN THE ISSUING OFFICE IS PROHIBITED

COPY NO.

MESSAGE FORM
TOTAL COPIES

SECRET

READING OFFICER INITIALS - SIGN BY		
1		
2		
3		
4		

ORIG:
UNIT:
EXT:
DATE:

CABLE SECRETARIAT DISSEMINATION

INDEX NO INDEX RETURN TO _____ BRANCH FILE RIO
 FILE IN CS FILE NO. _____

BY _____ PER _____
CONF: _____
FILE, VP, _____

(classification)

(date and time filed)

(reference number)

CITE DIRECTOR

7101776

TO

~~XXXXXXXXXXXX~~

~~XXXXXXXXXXXX~~

PAGE THREE (3)

~~XX~~

~~XX~~

~~XXXXXXXXXXXX~~

B. RETIREMENT CHECKS WAIVED WITHIN FIRST WEEK OF MONTH

FOLLOWING THAT FOR WHICH DUE.

END OF MESSAGE

CCCPD: C/AM/B&F

~~XXXXXXXXXXXX~~
C/AM/1

~~XXXXXXXXXXXX~~
C/AM/FL

~~XXXXXXXXXXXX~~
OP/Petirement

~~XXXXXXXXXXXX~~
GE/C&TD/S

~~XXXXXXXXXXXX~~
CCS/DF

~~XXXXXXXXXXXX~~
CF/

[Redacted Signature Box]

WILLIAM V. BROE
C/WID

[Redacted Signature Box]

WILLIAM S. FERRAN
C/AM/CONTRACTS

COORDINATING OFFICERS

SECRET

GROUP 1
Excluded from automatic
downgrading and
declassification

AUTHENTICATING OFFICER

RELEASING OFFICER

REPRODUCTION BY OTHER THAN THE ISSUING OFFICE IS PROHIBITED.

COPY NO

CLASSIFICATION		CONTROLLED INFORMATION		TOTAL COPIES		ROUTING AND INITIALS	
SECRET (When Filled In)		GROUP 1 EXCLUDED FROM AUTOMATIC DOWNGRADING AND DECLASSIFICATION		1		5	
ADVANCE COPY <input type="checkbox"/> ISSUED <input type="checkbox"/> NOTTED		REPRODUCTION OF THIS COPY PROHIBITED		2		6	
				3		7	
				4		8	

BY: _____ DATE: _____
 JAN 25 7 32 PM '71
 ACTION: COPY
 FILE, VR OF 2, CCS 2, CSIPS, OF 2
 ACTING NO 797

SECRET 20221Z JAN 71 CITE [] 5381

DIRECTOR 20 JAN 71 248431
 ADMIN CONTRACTS 4
 REF: A. [] 5083 ([] 226314)
 B. [] 5301 ([] 243202) 21 JAN 1971

- BENADUM HAS ASKED WHETHER NECESSARY FOR HIM TO SUPPLY HIS BANK WITH POWER OF ATTORNEY OR SIMILAR FORM TO ENABLE BANK TO CREDIT RETIREMENT CHECKS TO HIS ACCOUNT. REQUEST HEADQUARTERS ADVISE. ✓
- BENADUM ALSO ASKING WHETHER HE SHOULD RECEIVE CARD, ✓ CERTIFICATE OR OTHER EVIDENCE OF RETIREMENT FROM GOVERNMENT SERVICE INCLUDING LENGTH OF SERVICE CREDITED. PLEASE ADVISE.
- DUE DISRUPTION OF NORMAL INCOME PATTERNS, BENADUM EXPERIENCING FINANCIAL PROBLEMS AND REQUESTS PAYMENT OF FIELD ALLOTMENT FOR 13-31 DEC 70 SOONEST. REF B PROVIDED 1970 OVERT INCOME TAX ESTIMATE. ADVISE STATION OF NET AMOUNT FINAL FIELD ALLOTMENT SOONEST. ALSO ADVISE WHEN BENADUM CAN EXPECT FIRST RETIREMENT ✓ CHECK WILL BE SENT TO BANK. GP-1

SECRET

SECRET

Chief of Station, [redacted]

Chief, [redacted]

ADM/JICENT - Jeremy K. BENADUM (p) - Tax Administration

REFERENCE: [redacted] 5301, 13 January 1971

1. Headquarters has reviewed BENADUM's estimated 1970 and 1971 true tax liabilities and it has been determined that his current withholding rate is sufficient to provide enough tax for these years.

2. Please advise BENADUM of the above and remind him that we need copies of his 1970 and 1971 tax returns when they are submitted to Internal Revenue so that we can reconcile to his true tax liability.

[redacted]

Distribution:
Orig. & 2 - COS

9 FEB 1971

HMMS-7115

20 January 1971

SECRET

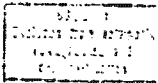

Internal Dist.

- 1 - WH/1
- 1 - WH/CON

CCS/CTS

WHM

LP

8697

WH/1

WH/CON

C/WH/SS

1. LAST NAME MUNRO	FIRST NAME George	INITIALS F	2. APPOINTMENT DATA Entered on duty: <input type="checkbox"/> F <input type="checkbox"/> P <input type="checkbox"/> E Subject to Sec. 2002(a) 1951 Leave Act Yes <input type="checkbox"/> No <input type="checkbox"/> Ceased to be subject to Sec. 203(d) Yes <input type="checkbox"/> No <input type="checkbox"/> Amended Leave Bill	3. TOTAL SERVICE FOR LEAVE (as of date of separation) Years: 31 Months: 1 Days: 25 <input type="checkbox"/> More than 15 years
4. DATE AND NATURE OF SEPARATION 12/31/70 TEST RETIREMENT				

SUMMARY OF ANNUAL AND SICK LEAVE (HOURS)			SUMMARY OF HOME LEAVE (DAYS)		REMARKS
	ANNUAL	SICK			
5. Balance from prior leave year ended 1/10 19 70	560	1128	14. Date arrival abroad for ML purposes		SCD: 11/7/39 *Unused Sick Leave-- 2228 hours-- 15 U.S.C. Ch 63 ^h
6. Current leave year accrual through 12/26 19 70	200	100	15. Current balance as of 19		
7. Total	760	2228	16. 12 month accrual rate		
8. Reduction in credits, if any (current year)	0	0	17. Dates leave used, prior 24 months		
9. Total leave taken	760	0	18. Monthly accrual date		
10. Balance	0	2228	19. Calendar days credit for next accrual date		
11. Total hours paid in lump sum None			20. Date basic service period completed		
12. Salary rate(s) 227,463			MILITARY LEAVE		
13. Lump sum leave dates: From _____ to _____ (Hours)			21. Dates during current calendar yr	to	
			22. Dates during preceding calendar yr	to	
14. CHIEF PAYROLL (Title) (Telephone)			ABSENCE WITHOUT PAY		
			23. During leave year in which separated 24. During step increase waiting period which began on 4/19/70 25. During 12 month ML accrual period (dates)		
			LAYUP or AWOL or Furlough Suspension (Hours) 0 0		

Standard Form 1150
November 1965
1150-106

RECORD OF LEAVE DATA TRANSFERRED

U.S. CIVIL SERVICE COMMISSION
FPM SUPPLEMENT 590-11 AND 990-1

TRANSMITTAL OF APPLICATION FOR RETIREMENT
CIA RETIREMENT AND DISABILITY SYSTEM

1. NAME OF EMPLOYEE (Last, First, Middle Initial)	2. TYPE OF RETIREMENT APPLIED FOR	3. PROPOSED RETIREMENT DATE
Munro, George F.	Voluntary	31 December 1976

SECTION A RECOMMENDATION OF FABRIK OFFICE

1. THE FOLLOWING ACTION IS RECOMMENDED FOR THE ATTACHED APPLICATION FOR RETIREMENT: APPROVAL
 DISAPPROVAL (Reason specified below)

2. TYPED NAME AND TITLE	4. DATE
[Redacted] WH/EXO	10 December 1976

SECTION B RECOMMENDATION OF HEAD OF CAREER SERVICE

1. THE FOLLOWING ACTION IS RECOMMENDED FOR THE ATTACHED APPLICATION FOR RETIREMENT: APPROVAL
 DISAPPROVAL (Reason specified below)

2. TYPED NAME AND TITLE	4. DATE
Cord Meyer, Jr., ADDP	10 Dec 76

SECTION C RECOMMENDATION OF CIA RETIREMENT BOARD

1. THE FOLLOWING ACTION IS RECOMMENDED FOR THE ATTACHED APPLICATION FOR RETIREMENT: APPROVAL
 DISAPPROVAL (Reason specified below)

14-00000

London, D.C.

31 July, 1970

To: . . . COS
From: . . . James K. Bandura
Subj.: . . . Retirement request

Writer herewith requests that his retirement date
be established as 31 December, 1970.

CONCUR:

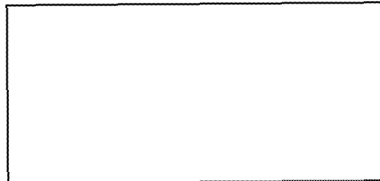

SECRET

30 DEC 1970

MEMORANDUM FOR : Mr. George F. Munro

THROUGH : Head of CS Career Service

SUBJECT : Notification of Approval of Request for
Voluntary Retirement

1. I am pleased to inform you that your request for voluntary retirement under the CIA Retirement and Disability System has been approved by the Acting Director of Central Intelligence.

2. Your retirement will become effective 31 December 1970. Your annuity will commence as of 1 January 1971 and is payable on 1 February 1971. You may be assured that every effort will be made to expedite delivery of your first check following completion of the administrative processing required to effect your retirement.

3. You will receive a lump-sum payment for your accrued annual leave up to 30 days or for whatever amount of leave credit you carried over from the last leave year if that amount is more than 30 days.

cc Robert S. Wattles

Robert S. Wattles
Director of Personnel

Distribution:

- 0 - Addressee
- 1 - D/Pers
- 1 - OPF
- 1 - ROB Soft File
- 1 - ROB Reader

OP/RAD/ROB/[]jat/3257 (28 December 1970)

SECRET

ORIG: [redacted] :md
UNIT: WII/Contracts
EXT: 4460
DATE: 30 December 1970

MESSAGE FORM
TOTAL COPIES: 14-2

SECRET

ROUTING AND/OR INITIALS - SEEN BY			
1		5	
2		6	
3		7	
4		8	

CABLE SECRETARIAT DISSEMINATION INDEX NO INDEX RETURN TO _____ BRANCH FILE RIO
BY 38 PER # FILE IN CS FILE NO _____

CONF: WII/8 FILE, VR. CP2, CSAs,

(classification) (date and time filed) (elite) (reference number) (pic)

SECRET

30 DEC 70 22 50z

CITE DIRECTOR 098292

TO [redacted]

ADMIN CONTRACTS

REF: [redacted] 5083 (IN 226314)

1. JEREMY K. BENADUM'S APPLICATION FOR RETIREMENT
EFFECTIVE 31 DEC 70 APPROVED BY CHIEF, JKLANCE.

2. EMPLOYMENT-SUMMARY APPROVED AS FOLLOWS:

26 OCT 39-31 JUL 40 U.S. ARMY, 2ND LT., 30TH INFANTRY DIV.

12 AUG 40-31 OCT 60 FBI.

1 NOV 60-31 DEC 70 RETIRED GOVT EMPLOYEE. [redacted]

[redacted]

[redacted]

(CONTINUED)

5
4
3
2
1

5
4
3
2
1

RELEASING OFFICER

COORDINATING OFFICERS

SECRET

GROUP 1
Excluded from automatic
downgrading and
declassification

AUTHENTICATING
OFFICER

REPRODUCTION BY OTHER THAN THE ISSUING OFFICE IS PROHIBITED.

COPY NO.

MESSAGE FORM
TOTAL COPIES:

SECRET

ROUTING AND/OR INITIALS - SEEN BY			
1		5	
2		6	
3		7	
4		8	

ORIG:
UNIT:
EXT:
DATE:

CABLE SECRETARIAT DISSEMINATION

INDEX NO INDEX RETURN TO _____ BRANCH FILE RID
 FILE IN CS FILE NO. _____

BY _____ PER _____ # _____

CONF: _____
FILE, VR, _____

(classification)

(date and time sent)

(elite)

(pic)

(reference number)

CITE DIRECTOR

to PAGE 2

70982927

[Redacted]

3. PLS ENSURE BENADUM IS PROVIDED PARA 2 INFO.

END OF MESSAGE

COORD: ^DC/WH/1 [Redacted]

WH/FI/ [Redacted]

WH/SS [Redacted]

[Redacted]

WILLIAM V. BROE
C/WH/D

RELEASING OFFICER

[Redacted]

WILLIAM S. RENEHAN
C/WH/CONTRACTS

AUTHENTICATING OFFICER

COORDINATING OFFICERS

SECRET

GROUP 1
Excluded from automatic
downgrading and
declassification

REPRODUCTION BY OTHER THAN THE ISSUING OFFICE IS PROHIBITED.

COPY 12A

ORIG: WS Renehan:md
CITE: WH/Contracts
EXT: 4460
DATE: 1 December 1970

MESSAGE FORM
TOTAL COPIES: 117

SECRET

ROUTING AND/OR INITIALS - CLEN E	
1	5
2	5
3	7
4	8

CABLE SECRETARIAT DISSEMINATION INDEX NO INDEX RETURN TO _____ BRANCH FILE RID

BY _____ PER _____ FILE IN CS FILE NO. _____

CONF: _____ FILE VR. CONF. SPS COS? (SPS CE?)

(classification) (date and time filed) (elite) (page)

SECRET

Dec 70 22 46Z

CITE DIRECTOR

090337

TO: [redacted]

ADMIN CONTRACTS

REF: [redacted] 4950 (IN 216442)

AND HOS FORESEES NO DELAY IN BENADUM'S RETIREMENT AS PER SCHEDULE.

1. PARA 2 REF EFFECTIVE DATE 31 DECEMBER 1970 CORRECT ✓
2. WHEN PARA 1 REF FORM SIGNED PLEASE ADVISE NUMBER

AND DATE TRANSMITTAL.

END OF MESSAGE

WH COMMENT: Advised Station has received retirement application for Jeremy K. BENADUM, and assumed delay will not effect Station plans to retire BENADUM on 31 Dec 1970.

TELECOORD: OP/RAD-Mr. [redacted]

COORD: C/WH/1 [redacted]

WH/FI/ [redacted]

[redacted]

WILLIAM V. BROE
C/WHID

[redacted]

WILLIAM S. RENEHAN,
C/WH/CONTRACTS

RELEASING OFFICER

SECRET

GROUP 1
EXCLUDED FROM AUTOMATIC
DOWNGRADING AND
DECLASSIFICATION

AUTHENTICATING OFFICER

REPRODUCTION BY OTHER THAN THE ISSUING OFFICE IS PROHIBITED.

COPY NO.

CLASSIFIED MESSAGE	TOTAL COPIES	COPIES AND/OR INITIALS SEEN
SECRET (When Filled In)		1 5
		2 6
		3 7
		4 8

CLASSIFIED MESSAGE: SECRET (When Filled In)

REPRODUCTION OF THIS COPY PROHIBITED

FILE, VR

150

SECRET 301315Z NOV 79 CITE [REDACTED] 4950

30 Nov 79 215432

DIRECTOR
ADMIN/CONTRACTS
REF: HWMS-7036

A

1. HAVE JUST RECEIVED REF WHICH FORWARDED RETIREMENT APPLICATION. JEREMY K. BENADUM IS PRESENTLY AWAY ON LEAVE AND WILL NOT RETURN UNTIL 5 DEC. HE WILL COMPLETE ^{FORM} FROM AT THAT TIME AND WE WILL INCLUDE IN SUBSEQUENT POUCH.

2. IT IS UNFORTUNATE THAT THIS PROCESSING HAS BEEN DELAYED SINCE WE HAD REQUESTED PROCESSING IN JUNE 1976. WE ASSUME THAT THIS DELAY WILL IN NO WAY AFFECT OUR PLANS TO RETIRE BENADUM ON 31 DEC 1976. GP-1

SECRET

SECRET

70-6/35

16 DEC 1970

MEMORANDUM FOR : Director of Central Intelligence

SUBJECT : Request for Voluntary Retirement -
Mr. ~~George F. Munro~~

George F. Munro

1. This memorandum submits a recommendation for your approval; this recommendation is contained in paragraph 4.
2. Mr. George F. Munro, GS-15 Equivalent, Career Agent, Western Hemisphere Division, Clandestine Service, has applied for voluntary retirement under the provisions of Headquarters Regulation 20-50j, to be effective 31 December 1970.
3. Mr. Munro has been designated a participant in the CIA Retirement and Disability System and meets the technical requirements for voluntary retirement under the System. He is 55 years old with over 31 years of Federal service. This service includes over 10 years with the Agency all of which were in qualifying service overseas. The Head of the Clandestine Service Career Service and the CIA Retirement Board have recommended that his application for voluntary retirement be approved. I endorse these recommendations.
4. It is recommended that you approve the voluntary retirement of Mr. George F. Munro under the provisions of Headquarters Regulation 20-50j.

Robert S. Wattles
Robert S. Wattles
Director of Personnel

The recommendation contained in paragraph 4 is approved:

R. S. Wattles

Director of Central Intelligence

16 Dec 1970

Date

Submitted

1. NAME (Last-First-Middle)		2. DATE OF BIRTH		3. U.S. NATURALIZATION DATE	
Munro, George F.		30 Oct 1960			
4. MARITAL STATUS	5. DEPENDENTS (Exclud. non-payers)	6. NUMBER OF BIRTHS	7. U.S. NATURALIZATION STATUS	8. LAST U.S. OFFICIAL TOUR	9. U.S. NATURALIZATION STATUS
Married	7	1917 1919 1961 1967	MA	1967	2
10. CAREER STATUS	11. OTHER STATUS	12. LAST U.S. OFFICIAL TOUR	13. U.S. NATURALIZATION STATUS	14. U.S. NATURALIZATION STATUS	15. U.S. NATURALIZATION STATUS
Staff	7-11-66	1967	MA	MA	MA
16. CURRENT POSITION	17. CURRENT GRADE	18. CURRENT DUTY STATION	19. CURRENT DUTY STATION	20. CURRENT DUTY STATION	21. CURRENT DUTY STATION
22. AGENCY EMPLOYMENT					
1937-40 Military Service, US Army, 1st Lt (9 mos)					
1940-60 Dept of Justice, FBI					
23. AGENCY EDUCATION					
7-36 Pomona College, Claremont, Calif (Graduate) - ?					
24. FOREIGN LANGUAGE ACQUISITION (Language, Proficiency, Date Tested)					
None					
25. AGENCY SPONSORED TRAINING					
None					
26. CIA EMPLOYMENT HISTORY SINCE 18 SEPT 1949 (Personal Actions, Military Orders, and Principal Details)					
Effective Date	Position Title & Occupational Code	Grade	MO	Organization & Organ. Title (If any)	Location
Oct 1970	CE Ops Off (Career Act)	C136.C1	27, h63 15/7-09V	DLP/SH/LITHHO	Mexico City
Apr 1966	" " " " " "	"	27, h63 15/7-09V	" " "	" "
Apr 1970	" " " " " "	"	27, h63 15/7-09V	" " "	" "
Sep 1970	Cps Of (Career Act)	C136.C1	27, h63 15/7-09V	" " "	" "
27. DATE PREPARED	28. OFFICE REVIEWED BY	29. OFFICE REVIEWED DATE	30. OFFICE REVIEWED DATE	31. OFFICE REVIEWED DATE	32. OFFICE REVIEWED DATE
2 Dec 1970	1c/ats				

SECRET
(When Filled In)

PERSONNEL NO.	BIOGRAPHIC PROFILE (PART 2)	
NAME (Last-First-Middle) Munro, George F.		DATE OF BIRTH
23. No Fitness Report in Official Personnel Folder. Subject's EQD date is CA in Oct 1947. No Photo Available.		
24. SUMMARY OF CAREER PREFERENCE OUTLINE AND/OR FIELD REASSIGNMENT QUESTIONNAIRE		
25. IDENTITY OF OTHER DOCUMENTS WHICH SHOULD BE REVIEWED IN DETAIL		
26. ADDITIONAL INFORMATION		
27. DATE RECEIVED 9 Dec 1970	28. PROFILE RECEIVED BY [Signature]	

UNCLASSIFIED INTERNAL USE ONLY CONFIDENTIAL SECRET

ROUTING AND RECORD SHEET

SUBJECT: (Optional)			
FROM: WH/Contracts 3D3102		EXEMPTION NO. 4460	DATE 16 December 1970
TO: (Officer designation, room number, and building)	DATE	OFFICER'S INITIALS	COMMENTS (Number each comment to show from whom to whom. Draw a line across column after each comment)
1. CCS/ GH GH-44 Mr. [redacted]			1, 3, 5: Your concurrences are requested on the attached resume for Jeremy K. BENADUM, Career Agent, who is retiring 31 Dec 70. BENADUM and the Station concur [redacted]
2. [redacted]	16 DEC 1970 17 Dec		
3. CI Staff 2 B 1405 Mr. [redacted]	19 Dec		
4. CI/EXO			
5. GHAD EAB/05 4E29 3E-49	28 Dec 70		
6. CI/EXO 2043	29 DEC 1970		
7. WH/Contracts 3D3102			
8.			
9.			
10.			
11.			
12.			
13.			
14.			
15.			

37 DEC 1970

FORM 610 INTERNAL USE ONLY SECRET CONFIDENTIAL INTERNAL USE ONLY UNCLASSIFIED

EMPLOYMENT RESUME

Mr. George Frederick Munro

31 December 1970

26 October 1939 - 31 July 1940

U. S. Army, 2nd Lt., 30th Infantry
Division.

12 August 1940 - 31 October 1960

FBI, ~~Special Agent~~

1 November 1960 - 31 December 1970

Retired Government Employee.

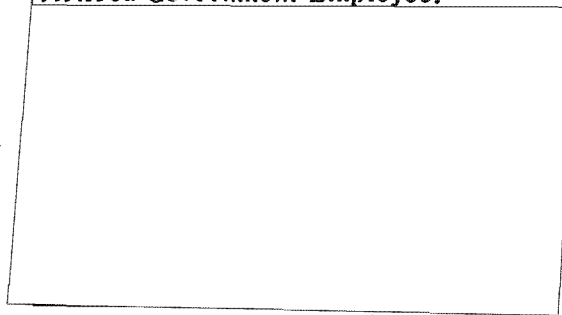

SECRET

17 October 1979

TO : DIRECTOR OF IN/CSTS
ATTENTION : C/C/DP
THROUGH : C/P/DP
INTRODUCTION : Benefits & Services Division
 W/C/DP
SUBJECT : Patient Progression - name, Frederick [redacted]
 (Career/Post)

[redacted]

[redacted]

3. All monies due Subject should be deposited to his [redacted] account with attribution to the U.S. Government. His bank account is as follows:

Wells Fargo Bank
44 California Street
San Francisco, California
Account [redacted]

SECRET

GROUP 1
EXCLUDED FROM AUTOMATIC
DOWNGRADING AND
DECLASSIFICATION

SECRET

4. Subject has a total of two group life insurance policies that are owned by the Agency. In his retirement status, a life policy would be convertible to term or some other type of insurance upon his retirement. However, this action could result in the surfacing of Subject's true identity to the underwriter. Therefore, in the interest of continuing security, Subject should be instructed to seek insurance with another insurer if he desires coverage following retirement.

5. If further information is needed, please contact OCS/DFI, [redacted] Fed 1353 or Black 6124.

[redacted]
Chief, Central Cover Staff
Naval Facilities Branch

SECRET

DISPATCH

CLASSIFICATION
SECRET

PROCESSING ACTION

TO	Chief, Western Hemisphere Division	X	MARKED FOR INDEXING
INFO			NO INDEXING REQUIRED
FROM	Chief of Station, [redacted]		ONLY QUALIFIED DESA CAN JUDGE INDEXING
SUBJECT	Forwarding of Retirement Application on Jeremy K. BENADUM		

ACTION REQUIRED - REFERENCES

REFERENCE: HMMS-7036

We are forwarding under separate cover a retirement application from Jeremy K. BENADUM.

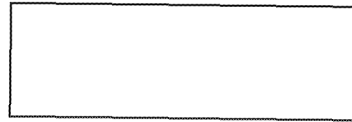

Attachment: U/S/C
Retirement Application

Distribution:
1 Orig & 2cc: C/WHD, w/att., U/S/C

Handwritten notes:
1 cc to [unclear]
1 cc to [unclear]
1 cc to [unclear]
1 cc to [unclear]

CLASSIFICATION	DISPATCH SYMBOL AND NUMBER	DATE
SECRET	HMMS-10-19	14 December 1970
	CLASSIFICATION	DISPATCH NUMBER

CONSIDER THE RESERVE CAUTION. NO CHANGE WILL BE PERMITTED AFTER AN ANNUITY HAS BEEN GRANTED. IF YOU WANT AN ANNUITY WITH A SURVIVOR BENEFIT, BE SURE TO GIVE THE OTHER INFORMATION CAREFULLY.

F. TYPES OF ANNUITY: MARRIED APPLICANTS ONLY

1. ANNUITY WITH SURVIVOR BENEFIT TO WIDOW OR WIDOWER

SPECIFY THE PORTION OF YOUR ANNUITY YOU WANT USED AS THE BASE FOR YOUR WIDOW'S (OR WIDOWER'S) SURVIVOR ANNUITY.

If you want all your annuity used as the base for the survivor benefit, write the word "all" in the box below. If you want only part of your annuity used as the base for the survivor benefit, write the yearly amount of your annuity you want used.

all THE SURVIVOR'S ANNUITY WILL BE 55% OF ALL OR WHAT EVER PORTION OF YOUR ANNUITY YOU SPECIFY AS THE BASE FOR HER (OR HIS) BENEFIT.

- If you are married, you will receive this type of annuity unless you choose the annuity in F. 2.
- The annuity payable to you during your lifetime will be reduced by 21% of any amount up to \$3,000 a year used as the base for the survivor benefit, plus 10% of any amount over \$3,000 so used.
- If you retire for total disability before age 60 and get a guaranteed minimum disability annuity, you may use all or any part of your "earned" annuity as the base for the survivor benefit. You cannot use any extra annuity which may be payable to make up the guaranteed minimum annuity.
- If your wife (or husband) should die before you, no change in type of annuity will be permitted, your annuity will not be increased, nor may you name any other person as survivor.
- The survivor's annuity will begin upon your death and end when she (or he) dies or remarries.

2. ANNUITY WITHOUT SURVIVOR BENEFIT

(I do not desire my wife (or husband) to receive a survivor annuity benefit after my death.)

- If you choose this type, your wife (or husband) cannot be paid a survivor annuity after your death.
- This type provides annuity payments to you only.

G. TYPES OF ANNUITY: UNMARRIED APPLICANTS ONLY (Including Widowed and Divorced)

1. ANNUITY WITHOUT SURVIVOR BENEFIT

- If you are not married, you will receive this type of annuity unless you choose the annuity in G. 2.
- This type provides annuity payments to you only.

2. ANNUITY WITH SURVIVOR BENEFIT TO RELATED PERSON HAVING AN INSURABLE INTEREST

SPECIFY THE RELATIONSHIP AND DATE OF BIRTH OF THE PERSON YOU WISH TO RECEIVE THE SURVIVOR ANNUITY.

NAME OF PERSON (Last, middle, first)

RELATIONSHIP DATE OF BIRTH (Mo., day, yr.)

SEE UNMARRIED EMPLOYEES UNDER INFORMATION REGARDING SURVIVOR ANNUITIES ON THE ATTACHED INFORMATION SHEET FOR EXPLANATION OF TERMS.

- This type is available to all retiring *unmarried* employees who are in good health.
- It provides a reduced annuity to you and a survivor annuity to the person named as having an insurable interest.
- The survivor's annuity will begin upon your death and end when she (or he) dies.
- The survivor's annuity will be 55% of the reduced annuity you receive.
- If you choose this type, you will have to undergo a medical examination which will be arranged by the Director of Personnel at no cost to you.
- If the person named as having an insurable interest should die before you, no change in type of annuity will be permitted, your annuity will not be increased, nor may you name any other person as survivor.

H. CERTIFICATION OF APPLICANT

WARNING—Any intentional false statement in this application or willful misrepresentation relative thereto is a violation of the law punishable by a fine of not more than \$10,000 or imprisonment of not more than 5 years, or both (18 U.S.C. 1001).

I hereby certify that all statements made in this application are true to the best of my knowledge and belief.

10 Dec., 1970. *Gary F. Munn*
(Date) (Signature of Applicant)

I. FOR OFFICE OF PERSONNEL USE ONLY

Blank area for Office of Personnel use only.

Contract Service - Timothy K. Bonadom (P)

<u>Date</u>	<u>Action</u>	<u>Compensation</u>	<u>GS Equivalent</u>
30 Oct 60	Hired as a Career Agent with CIA's PSIs and Civil Service Retirement.	13,770	GS-15/1
27 Aug 18 Oct 62	PSI	14,055	GS-15/2
14 Oct 62	LPI	15,045	GS-15/2
26 Apr 63	PSI	15,525	GS-15/3
5 JAN 64	LPI	16,695	GS-15/3
26 Apr 64	PSI	17,210	GS-15/4
5 July 64	LPI	18,170	GS-15/4
10 Oct 65	LPI	18,825	GS-15/4
24 Apr 66	PSI	19,415	GS-15/5
3 Jul 66	LPI	19,978	GS-15/5
24 Sep 67	Contract terminated	19,978	GS-15/5
25 Sep 67	Career Agent with Civil Service Retirement, LPAs and PSIs.	19,978	GS-15/5
8 Oct 67	LPI	20,856	GS-15/5
21 Apr 68	PSI	21,469	GS-15/6
14 Jul 68	LPI	23,075	GS-15/6
13 Jul 69	LPI	25,189	GS-15/6
24 Aug 69	Designated participant in the CIA Retirement and Disability System.		
28 Dec 69	LPI	26,700	GS-15/6
19 Apr 70	PSI	27,463	GS-15/7
10 Jan 71	LPI	29,099	"

UNIT: [redacted]
UNIT: C/WH/Contracts
EXT: 4460
DATE: 7 December 1970

TOTAL COPIES 15-1
SECRET

1	2
3	4
5	6
7	8
9	10

WHILE SECRETARIAL DISSEMINATION INDEX NO INDEX RETURN TO _____ BRANCH FILE RID
 FILE IN CS FILE NO. _____

FILE NO. WH-8 PER. [redacted] FILE, VR. 1 CCS-2, OP-2

(classification) S.E.C.R.E.T. (date and time filed) (initials) (reference number) CITE DIRECTOR 92724

TO: [redacted]

ARMY CONTRACTS

REFS: A. [redacted] 4904 (IN 212197)
B. DIRECTOR 086503

PLEASE PROVIDE FULL NAME AND ADDRESS OF JEREMY K. BEHADOM'S
[redacted]

END OF MESSAGE

- WH COMMENTS: a. Concurrence to proposed employment summary.
- b. Proposed employment summary.

TELECOORD: CCS/DF [redacted]
COORD: C/WH/1 [redacted]
C/WH/FI/ [redacted]

[redacted]
WILLIAM V. BROE
C/SID

[redacted]
WILLIAM S. REISMAN
C/WH/CONTRACTS

COORDINATING OFFICERS
RELEASING OFFICER [redacted] AUTHENTICATING OFFICER [redacted]

SECRET

GROUP 1 Excluded from automatic downgrading and declassification

REPRODUCTION BY OTHER THAN THE ISSUING OFFICE IS PROHIBITED.

COPY NO.

CLASSIFIED MESSAGE

TOTAL COPIES

ROUTING AND/OR INITIALS

SECRET

(When Filled In)

CLASSIFIED BY [] UNCLASSIFIED BY []

REVISIONS OF THIS COPY



FILE, VR

150

SECRET 301315Z NOV 79 CITE [] 495Z

DIRECTOR

30 NOV 21 04:2

ADMIN/CONTRACTS

A

REF: HMMS-7036

1. HAVE JUST RECEIVED REF WHICH FORWARDED RETIREMENT APPLICATION. JEREMY K. BENADUM IS PRESENTLY AWAY ON LEAVE AND WILL NOT RETURN UNTIL 5 DEC. HE WILL COMPLETE ^{FOPM} FORM AT THAT TIME AND WE WILL INCLUDE IN SUBSEQUENT POUCH.

2. IT IS UNFORTUNATE THAT THIS PROCESSING HAS BEEN DELAYED SINCE WE HAD REQUESTED PROCESSING IN JUNE 1976.

1 DEC 1970

WE ASSUME THAT THIS DELAY WILL IN NO WAY AFFECT GCF PLANS TO RETIRE BENADUM ON 31 DEC 1976. GP-1

SECRET

*When form is received
No. []*

11/1

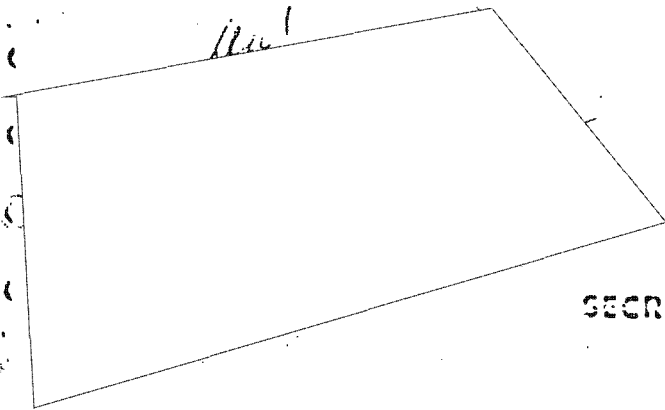

SECRET

ORIG: WSRenehan:md
UNIT: WH/Contracts
EXT: 4160
DATE: 1 December 1970

MESSAGE FORM
TOTAL COPIES: 111

SECRET

1	5
2	6
3	7
4	8

W

CABLE SECRETARIAT DISSEMINATION INDEX NO INDEX RETURN TO _____ BRANCH FILE RID

BY _____ PER _____ # _____ FILE IN CS FILE NO. _____

CONF: *W/O* FILE: VII. *072 0525 0525 0525 0525*

(classification) (date and time filed) (ref) (pic)

SECRET

1 Dec 70 22 46Z

CITE DIRECTOR
090337

TO: [Redacted]

ADMIN CONTRACTS

REF: [Redacted] 4950 (IN 216442)

AND HQS FORESEES NO DELAY IN BENADUM'S RETIREMENT AS PER SCHEDULE.

1. PARA 2 REF EFFECTIVE DATE 31 DECEMBER 1970 CORRECT
2. WHEN PARA 1 REF FORM SIGNED PLEASE ADVISE NUMBER AND DATE TRANSMITTAL.

END OF MESSAGE

WH COMMENT: Advised Station has received retirement application for Jeremy K. BENADUM, and assumed delay will not effect Station plans to retire BENADUM on 31 Dec 1970.

TELECOORD: OP/RAD-Mr. [Redacted]

COORD: C/WH/1 [Redacted]

WH/FI/ [Redacted]

[Redacted]

WILLIAM V. BROE
C/WHID

[Redacted]

WILLIAM S. RENEHAN
C/WH/CONTRACTS

RELEASING OFFICER

SECRET

GROUP 1
Excluded from automatic
downgrading and
declassification

AUTHENTICATING OFFICER

REPRODUCTION BY OTHER THAN THE ISSUING OFFICE IS PROHIBITED.

COPY NO.

CABLE SECRETARIAT DISSEMINATION

CLASSIFIED MESSAGE

TOTAL COPIES 17-1

ROUTING AND/OR INITIALS SEEN

ADVANCE COPY <input type="checkbox"/> ISSUED <input type="checkbox"/> PLOTTED <input type="checkbox"/>	SECRET (When Filled In)		GROUP 1	5
	REPRODUCTION OF THIS COPY PROHIBITED		GROUP 2	6
			GROUP 3	7
			GROUP 4	8
BY _____ AT _____ Z		NOV 23 1970		
CLASSIFIED BY _____ PER _____				
ACTION BY _____		FILE, VR CCS-2, OF-2, OP-2		

SECRET 231000Z NOV 70 CITE [] 4504 23 NOV 212197

DIRECTOR

ADMIN CONTRACTS

REF: DIRECTOR 303923

1. CONCUR EMPLOYMENT SUMMARY PER PARA 1 REF.

2. ALLOTTED DESIGNATED: WELLS FARGO BANK,

464 CALIFORNIA ST., SAN FRANCISCO, CALIF. ACCT. [] CP-1

SECRET

Copy sent to [unclear] - had seen [unclear] 30 Nov 70

[Signature]

24 NOV 1970

SECRET

Chief of Station,

Chief, Retirement Affairs Division

Retirement application and related information - Jeremy K. BENADUM

Reference: HMMS-1-10467

1. Since Jeremy K. BENADUM has expressed a desire to retire in December 1970, he should complete and return to Headquarters the attached application for Retirement form. He may have his annuity checks sent directly to his bank for deposit if he wishes. This should be arranged with whatever bank is designated under Item 4 on the application. His checking account number should be recorded following the name of the bank. Items B-1 through B-4 may be left blank to be filled in at Headquarters. Since Subject's annuity will begin on the first day of the month following retirement, it is considered advantageous to make his retirement effective as of the last day of the month. In this way his annuity would commence the day following his last day as an employee.

2. When BENADUM retires, his regular Federal Employees Group Life Insurance (without accidental death and dismemberment benefits) will be continued at the same amount without further cost. The cost of the optional FEGLI, which he is eligible to continue, will be deducted from his annuity until he reaches age 65. These insurances will retain face value until BENADUM reaches age 65 at which time they will reduce at the rate of 2 per cent per month until they reach 25 per cent of their face value. If he wishes, Subject may elect at the time of retirement to convert to an individual life insurance policy in order to retain lifetime coverage in an amount equal to his present insurance. He must pay the premium applicable to the type of policy selected. A medical examination will not be required under the conversion privilege.

(continued)

Attachments:

Application for Retirement

Distribution:

1 - COS

HMMS-7036

18 Nov 1970

SECRET

1 - WH/Pers
3 - ROB

OP/RAD/ROB/

jat

(13 Nov 1970)

3257

AC/ROB

C/WH/Pers

C/WH/SS

3. Subject may also continue his enrollment under his health benefits plan. Premiums will continue at the same rate as that for employees and will be withheld from his monthly annuity payments.

4. Under the provisions of 5 USC 20-14c(2) Subject's prospective retirement precludes him from becoming eligible for home leave upon completion of his present tour.

5. BENADUM's request for retirement will be processed as expeditiously as possible following receipt of his completed application forms. Upon approval of his retirement by Chief, JELANCA, Subject will be notified.

for [redacted]
[redacted]

ORIG: WSRenehan
UNIT: WH/Contracts
EXT: 446
DATE: 13 November 1970

MESSAGE FORM
TOTAL COPIES: 17

SECRET

ROUTING AND/OR INITIALS - SIGN BY			
1		5	
2		6	
3		7	
4		8	

CABLE SECRETARIAT DISSEMINATION INDEX NO INDEX RETURN TO _____ BRANCH FILE RID

BY _____ PER _____ # _____ FILE IN CS FILE NO. _____

CONF: WH/ FILE, VR. CCS-2 (OF-2) CP-2

(classification) (date and time filed) (initials) (page)

SECRET

13 NOV 70 22:22

CITE DIRECTOR

TO [redacted]

036503

ADMIN CONTRACTS

REF: FN 20-99

16 NOV 1970

1. HQS PROPOSES FOLLOWING EMPLOYMENT SUMMARY FOR JEREMY K. BENADUM. PLEASE ADVISE COMMENTS/CONCURRENCE.
 - A. ACTUAL EMPLOYERS TO DATE OF JKLANCE CONTRACT.
 - B. FOR PERIOD JKLANCE EMPLOYMENT 1 NOVEMBER 1960 THROUGH 31 DECEMBER 1970 RETIRED U. S. GOVERNMENT EMPLOYEE [redacted]
2. ABOVE WILL PERMIT PAYMENT OF ANNUITY BY GOVERNMENT CHECK WHICH WILL SEND CURRENTLY DESIGNATED ALLOTTEE UNLESS OTHERWISE ADVISED.

END OF MESSAGE

COORD: C/WH/ [redacted]
WH/FL [redacted]
CCS/DF [redacted]
CCS/CTS [redacted]
W. S. RENEHAN
C. WH CONTRACTS

WILLIAM V. BROE
C/WH/D
DELEGATED OFFICER

SECRET

CO. G: WSPenchan
UNIT: W/Contracts
EAT: 4460
DATE: 30 Oct 70

MESSAGE FORM
TOTAL COPIES

SECRET

ROUTING AND/OR INITIALS - SEEN BY	
1	
2	
3	
4	

CABLE SECRETARIAT DISSEMINATION INDEX NO INDEX RETURN TO _____ BRANCH FILE RID
BY: LS PER _____ # _____ FILE IN CS FILE NO. _____

CONF: (W/8) FILE. VR. D/S.R. O.P.R.
(classification) (date and time filed) (letter) (reference number) (place)

SECRET 30 Oct 70 17 39, CITE DIRECTOR 082587

to **PRIORITY**
[Redacted]

ADMIN CONTRACTS
REF: [Redacted] 4672 (IN 193185)

THERE IS NO REQUIREMENT FOR A PRE RETIREMENT PHYSICAL;
HOWEVER, COMPLETION OF TOUR PHYSICALS ARE AUTHORIZED. SEE
FR 15-1. RESULTS OF PHYSICALS MUST BE FORWARDED HQS WHEN
COMPLETED.

EID OF MESSAGE

WH COMMENT: Advise what portion of expenses incurred for
physical exams are reimbursable.

COORD: C/M/I/L [Redacted]
C/M/I/CA [Redacted]
DD/PERS-SP [Redacted]
O/S Mr. [Redacted] (in draft)

7:00 PM
[Signature]

[Redacted]
WILLIAM V. BING
C/M/I/D

[Redacted]
WILLIAM V. BING
C/M/I/CONTRACTS

COORDINATING OFFICER
RELEASING OFFICER **SECRET** AUTHENTICATING OFFICER

TABLE SECRETARIAT DISSEMINATION		CLASSIFIED MESSAGE	TOTAL COPIES	ROUTING AND/OR INITIALS SEEN BY	
PERMISSION NOTIFIED		SECRET (When Filled In)	GROUP 1 EXCLUDED FROM AUTOMATIC DOWNGRADING AND DECLASSIFICATION	1	5
				2	6
ADVANCE COPY	<input type="checkbox"/> ISSUED	<input checked="" type="checkbox"/> RELEASED	PRODUCTION OF THIS COPY PROHIBITED	3	7
				4	8
BY: _____ AT _____		OCT 26 3 37 PM '70			
DISSEM BY: _____ PER _____		ACTION COPY			
ACTION NO. _____		FILE, VR OP2 JMS 2			
181					

SECRET 261940Z OCT 70 CITE [] 4672 26 OCT 193185

DIRECTOR

ADMIN PERS

- JEREMY K. BENADUM HAS ARRANGED TO HAVE COMPLETE PHYSICAL EXAMINATION WITH FAMILY PHYSICIAN IN SAN FRANCISCO, CALIF DURING PERSONAL TRIP THERE IN LATE OCT 70. HE HAS ASKED WHAT PORTION OF EXPENSES THEREFOR ARE REIMBURSABLE BY JKLANCE.
- STATION CAN FIND NO INFORMATION ON PRE-RETIREMENT PHYSICALS. HEADQUARTERS GUIDANCE IS REQUESTED. GP-1

SECRET

27 Oct 70

SECRET

130000
140000
150000
160000
170000
180000
190000
200000
210000
220000
230000
240000
250000
260000
270000
280000
290000
300000
310000
320000
330000
340000
350000
360000
370000
380000
390000
400000
410000
420000
430000
440000
450000
460000
470000
480000
490000
500000

SECRET

15 21 232 8079

CITE DELETION 067983



1. CONTRACT LIFE INSURANCE PREMIUM IN THE AMOUNT OF \$40.00 FOR JEREMY K. BENNETT PAY PERIOD 23 AUGUST THROUGH 19 SEPTEMBER 1970, PAY AND T/A TO BE DEDUCTING THE SUM OF \$1,476.23.
2. NET DUE PREMIUM WILL BE \$1,422.23 EACH PAY PERIOD THEREAFTER.

END OF MESSAGE

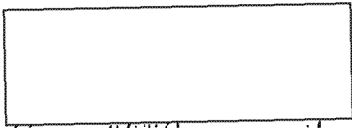

C/WH/A

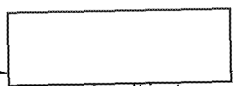

17 SEP 1970



J. K. Bennett
C/WH/A

[Signature]
C/WH/A

SECRET

SECRET

SECRET

SECRET

SECRET (When Filled In)		GROUP 1	5
REPRODUCTION OF THIS COPY PROHIBITED		GROUP 2	6
INDEX: <input type="checkbox"/> YES <input type="checkbox"/> NO		GROUP 3	7
CLASSIFY TO CS FILE NO. _____		GROUP 4	8
APP TO CS FILE NO. _____			
<input type="checkbox"/> FILE RID <input type="checkbox"/> RETURN TO _____		BRANCH _____	
ACTION UNIT		FILE, VR	
W18		CC32, CS, PS, OP2, F12	
ACTION NO.		486	

SECRET 272327Z JUL 70 CITE [] 3778

DIRECTOR

ADMIN CONTRACTS

27 JUL 70 130647
M

REF: HMMS-6919

1. IT IS STATION UNDERSTANDING THRU LNPURE THAT EMPLOYEE CONTINUES TO RECEIVE ALLOWANCES, E.G., QUARTERS AND EDUCATIONAL, WHILE IN A LEAVE STATUS UNTIL DATE OF REQUIREMENT BUT THAT EMPLOYEE UNDER THEIR SYSTEM NOT ALLOWED TO TAKE ANNUAL LEAVE IN LIEU OF LUMP SUM PAYMENT.

2. HOWEVER, JEREMY K. BENADUM IS RETIRING UNDER JKLANCE SYSTEM, AND SHOULD STATION DECIDE TO RETIRE HIM AS OF 31 DEC 70, WOULD HE BE ELIGIBLE FOR BOTH QUARTERS AND EDUCATIONAL ALLOWANCES THRU THIS DATE?

3. STATION REQUIRES ANSWER TO PARA 2 BEFORE ADVISING BENADUM OF OUR DECISION. GP-1

SECRET

SECRET

DISPATCH

CLASSIFICATION
SECRET

PROCESSING ACTION

TO Chief, WH Division

X

MARKED FOR INDEXING

NO INDEXING REQUIRED

INFO.

ONLY QUALIFIED DESK
CAN JUDGE INDEXING

FROM

Chief of Station

MICROFILM

SUBJECT

ADMIN/RETIREMENT
Jeremy K. BENADUM

ACTION REQUIRED - REFERENCES

REFERENCE: HMMT-10467, 14 August 1970

1. Although we are certain that the following information is available at Headquarters, Jeremy K. BENADUM has requested that it be brought to the attention of the Retirement Office.

2. At the time of his retirement from LNERGO, 31 October 1960, he was paid \$3,177.40 for annual leave accrued. This money was then turned over to JKLANCE via a check written on 5 September 1961. Income Tax charges had already been deducted from this total.

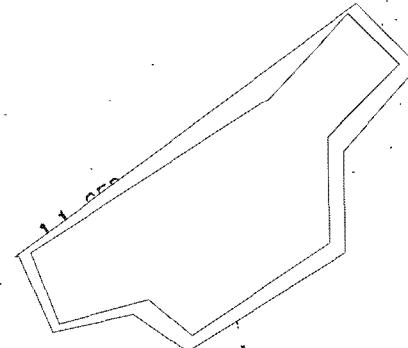
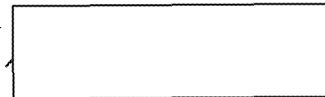

Distribution:
Orig & 2cc: C/WH

CROSS REFERENCE TO

DISPATCH SYMBOL AND NUMBER

DATE

HMMT-10486

31 August 1970

CLASSIFICATION

HQS FILE NUMBER

SECRET

S E C R E T

Chief of Station [redacted]

Chief, PR Division
ADMIN/CONTRACTS
Jeremy A. BENADUM, Retirement

Action Required: Para 3
Reference : HHSF-10,467, Para 3

1. Reference indicated: Jeremy A. BENADUM advises his present plans call for him residing in the U.S. for a period of six months each year; he plans to return to the U.S. after 31 December 1970 and has asked the Station about reimbursement for the travel for himself and his family.

Ref asked whether return travel is authorized.

2. FR 22-2 provides: "Upon retirement while assigned abroad, ..., travel and transportation expenses from the last post of assignment to the place where the employee will reside in the U.S., ..." FR 22-21 specifies the time limit within which travel must be performed.

The above does permit BENADUM to be reimbursed for travel of self and authorized dependents after his retirement (31 Dec 70) to the place in the U.S. where he will reside.

3. STATION ACTION:

It is suggested BENADUM be asked to submit a written request for transmittal to Headquarters in which he cites the place in the U.S. where he will reside, the names of the dependents who will travel with him, mode of travel and, if known, the itinerary.

Upon receipt of the above, Headquarters will process a Request for Travel Orders and, upon approval, will advise the Station.

Distribution: 2-COS, [redacted]

HHSF-5960

28 AUG 1970

S E C R E T

1-OP/CPD
1-WH/B&F
1-WH/FI [redacted]
1-WH/1
1-WH/Registry
1-WH/Contracts

WH/Contracts SRenehan DE (24 Aug 70) 4460

C/OP/CPD

C/WH/B&F

C/WH/1

WH/FI [redacted]

DISPATCH		CLASSIFICATION S E C R E T	PROCESSING ACTION
TO	Chief, WM Division		XX NO INDEXING REQUIRED
INFO.	[Redacted]		ONLY QUALIFIED DESK CAN JUDGE INDEXING
FROM	Chief of Station	[Redacted]	MICROFILM
SUBJECT	ADMIN/CONTRACTS Jeremy K. BENADUM - Retirement		
ACTION REQUIRED - REFERENCES			
Reference: HBMS-6919			
<p>1. After careful review at the Station and discussions with Jeremy K. BENADUM, we have concluded that the most amicable and efficient separation date for BENADUM would be 31 December 1970. In our review of costs, we find the additional benefits to BENADUM result primarily from his additional two months of service increasing his retirement benefits.</p> <p>2. Based on this decision we plan on having him begin leave on 14 August 1970 and are therefore submitting the following papers as requested in reference.</p> <ul style="list-style-type: none"> a) Attached is the signed original copy of an amendment contract which provides for his participation in the Organization Retirement Program. b) A memo prepared by BENADUM requesting approval for him to retire 31 December 1970, and which is concurred in by the Chief of Station. c) A statement in lieu of a copy of his discharge papers. As outlined in this statement, BENADUM indicates he never received an official discharge. d) [Redacted] <p>3. BENADUM has indicated his present plans call for him residing in the U.S. for a period of six months each year. He plans to return to the States after 31 December 1970 and has queried the Station regarding reimbursement for return travel to the U.S. for himself and family. In future correspondence please indicate whether return travel is authorized.</p>			
Distribution: 3 - C/WMID w/atts. herewith [Redacted]			
CROSS REFERENCE TO	DISPATCH SYMBOL AND NUMBER	DATE	
	HMNT-10,467	11 AUGUST 1970	
	S E C R E T	[Handwritten signatures and initials]	

SECRET

Mr. Jeremy K. Benadum

Dear Mr. Benadum:

Reference is made to your contract with the United States Government, as represented by the Contracting Officer, effective 20 October 1960.

The purpose of this amendment is to formally record your official designation as a participant in the Retirement and Disability System of this organization, effective 24 August 1969. Your contributions into the Retirement and Disability Fund will be deducted by this organization as of that date. The regulations governing this retirement system gives the individual the right to appeal such a determination if he deems the designation adverse to his best interest. In order that this technical requirement may be satisfied, you are hereby notified of your right to appeal. An appeal with reasons therefor must be received in this organization within thirty (30) days from the date of your acknowledgment of this contract amendment.

Effective close of business 23 August 1969 all contractual reference to Civil Service Retirement and your contributions thereto is deleted.

Social Security contributions required by virtue of your employment will not be reimbursed you by this organization.

All other terms and conditions of this contract remain in full force and effect.

UNITED STATES GOVERNMENT

APPROVED:

Jeremy K. Benadum

BY _____
Contracting Officer

[Redacted]

31 July, 1970

To: CO3
From: Jeremy K. Benadum
Subj.: Retirement request

Writer herewith requests that his retirement date
be established as 31 December, 1970.

CONCUR:

[Redacted]

[REDACTED]
31 July, 1970

To: C63
From: Jeremy K. Benedum
Subj.: Military Service

Upon graduation from Pomona College, Claremont, California, in June, 1936, writer was commissioned as 2nd Lt. of Infantry. On October 25, 1939, writer went on active duty under the Thomason Act, being assigned to duty with the 30th U.S. Infantry, with headquarters at the Presidio, San Francisco, California. He remained on active duty until 30 July, 1940, at which time he reverted to reserve status. Writer remained in this status, with the rank of 1st Lt. until 1942, at which time all reserve officers in the FBI were requested to resign their commissions. The latter was done under an arrangement between the Defense Dept. and the FBI. Writer has never received a discharge, so is unable to produce same.

[Redacted]

31 July, 1970

To: COS

From: Jeromy K. Bonadum

Subj.: [Redacted]

[Redacted]

SECRET

2-10-70

MEMORANDUM FOR: Director of Personnel

SUBJECT : Jeremy K. BENADUM, Terminal
Annual Leave

REFERENCE : HR 20-30 c (4)

1. It is requested that approval be granted for Jeremy K. BENADUM, Career Agent, to use accumulated annual leave prior to his retirement on 31 December 1970.

2. BENADUM has been assigned PCS to [redacted] and will retire in place. He has a maximum leave carryover of 560 hours plus leave accrued during 1970. BENADUM's request that he be permitted to use accrued annual leave in lieu of a lump-sum payment was endorsed by the [redacted]

3. The Chief of Station, prior to departure for [redacted] recommended that BENADUM's request be approved. This was based on operational considerations which are in the best interests of the Agency for there to be an amicable separation when BENADUM retires.

4. The WH Division recommends favorable consideration be accorded this request.

William V. Broe
Chief
Western Hemisphere Division

SECRET

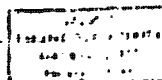

SECRET

- 2 -

SUBJECT: Jeremy K. BENADUM, Terminal Annual Leave

CONCUR:

[Redacted]

DDP/NSP

APPROVED:

[Redacted]

Director of Personnel

21 JUL 1970

DDP/WH/Contracts:WSRenehan:md (20 July 1970)

Distribution: Orig - WH/Contracts

1 - Addressee

1 - DDP/NSP

1 - CPD

1 - WH/1

SECRET

3 10 70

MEMORANDUM FOR: Chairman, Clandestine Service Agent Panel
SUBJECT : Promotion Review of Career Agents
REFERENCE : Your Memorandum, Same Subject, dated 17 July 1970

1. Western Hemisphere Division has completed its review of GS-14 and above career agents. [redacted], who is currently serving in [redacted] has not been included in this review since he is home-based in the Soviet Bloc Division.
2. Attached are NSP Data Sheets on our four career agents in this GS-equivalent bracket, a ranking of these agents, and a promotion nomination for [redacted]

(Signed) William V. Broe

William V. Broe
Chief
Western Hemisphere Division

Attachments

cc: DDP/NSP

DDP/WH/FI/EXO:J. Di Stefano:mj (30 Jul 70)

Distribution:

- Orig. & 1 - Addressee
- 1 - DDP/NSP
- 1 - WH/EXO
- 1 - WH/SS
- 1 - WH/CTS
- 1 - WH/FI/[redacted]

SECRET

WH DIVISION RANKING OF GS-14 CAREER AGENTS

	<u>Last Promotion</u>
1. [REDACTED] *	May 1963
2. Henry J. SLOMAN	December 1965

WH DIVISION RANKING OF GS-15 CAREER AGENTS

	<u>Last Promotion</u>
1. [REDACTED]	December 1968
2. Jeremy K. BENADUM **	October 1960

* Nominated for promotion
** Scheduled for retirement 31 December 1970

SECRET

ORIG: WSRenehan
USNG: WH/Contracts
FAC: 4460
DATE: 28 July 1970

MESSAGE FORM
TOTAL COPIES: 17

SECRET

ROUTED AND/OR DETAILS - SEEN BY			
1		5	
2		6	
3		7	
4		8	

CABLE SECRETARIAT DISSEMINATION INDEX NO INDEX RETURN TO _____ BRANCH FILE RID
BY: 24 PER: _____ FILE IN CS FILE NO. _____

CONF: WH-S | 1/5 | FILE VR. CC-5-2, CS-5, CO-2, FC-2

(classification)

(date and time filed)

(file)

(page)

SECRET

20 21 07z JUL 70

CITE DIRECTOR

TO: [redacted]

054685 7

ADMIN CONTRACTS

REFS: A. [redacted] 3778 (IN 130647)

B. HMMS-6919

1. EXCEPTION APPROVAL TO PERMIT USE OF ACCRUED LEAVE IN LIEU LUMP-SUM PAYMENT, GRANTED ON BASIS OPERATIONAL CONSIDERATIONS CITED PARA 2 REF B.

2. ASSUMING BENADUM'S ELIGIBILITY TO RECEIVE ALLOWANCES FOR PERIOD PARA 2-REF A (REMAINS IN PLACE, CHILDREN ENTERED IN SCHOOL) HE THEREFORE ENTITLED RECEIVE THE ALLOWANCES.

END OF MESSAGE

WH COMMENTS: A should Station decide to retire BENADUM as of 31 Dec 70, would he be eligible for allowances thru that date.

B. BENADUM - Retirement; [redacted]

[redacted]

COORD: C/WH/1 [redacted]

OP/CPD [redacted]

WILLIAM V. BRUCE
C/WH/D

WILLIAM S. RENEHAN
C/WH/CONTRACTS

COORDINATING OFFICERS

RELEASING OFFICER

SECRET

GROUP 1
Excluded from automatic
downgrading and
declassification

AUTHENTICATING OFFICER

REPRODUCTION BY OTHER THAN THE ISSUING OFFICE IS PROHIBITED.

COPY NO.

SECRET (When Filled In)		GROUP 1 EXCLUDED FROM AUTOMATIC DOWNGRADING AND DECLASSIFICATION	5	C
ADVANCE COPY <input type="checkbox"/> ISSUED <input type="checkbox"/> PLOTTED	REPRODUCTION OF THIS COPY PROHIBITED		6	
BY: _____ AT: _____	INDEX: <input type="checkbox"/> YES <input type="checkbox"/> NO		7	
CLASSIFY TO CS FILE NO. _____			8	W
CLASSIFY TO CS FILE NO. _____				
CLASSIFY BY 23.	<input type="checkbox"/> FILE RID <input type="checkbox"/> RETURN TO _____			
ACTION UNIT	FILE, VR	CC52, 25PS, GP2, F12		
ACTION NO.				
486				

SECRET 272327Z JUL 70 CITE [] 3778

DIRECTOR

ADMIN. CONTRACTS

27 JUL 70 130647
M

REF: HMMS-6919

1. IT IS STATION UNDERSTANDING THRU LMPURE THAT EMPLOYEE CONTINUES TO RECEIVE ALLOWANCES, E.G., QUARTERS AND EDUCATIONAL, WHILE IN A LEAVE STATUS UNTIL DATE OF RETIREMENT BUT THAT EMPLOYEE UNDER THEIR SYSTEM NOT ALLOWED TO TAKE ANNUAL LEAVE IN LIEU OF LUMP SUM PAYMENT.
2. HOWEVER, JEREMY K. BENADUM IS RETIRING UNDER JKLANCE SYSTEM, AND SHOULD STATION DECIDE TO RETIRE HIM AS OF 31 DEC 70, WOULD HE BE ELIGIBLE FOR BOTH QUARTERS AND EDUCATIONAL ALLOWANCES THRU THIS DATE?
3. STATION REQUIRES ANSWER TO PARA 2 BEFORE ADVISING BENADUM OF OUR DECISION. .GP-1

SECRET

SECRET

24 July 1970

INSTRUCTIONS: 1. Domestic Use Only
 A. CONTRACT EMPLOYEES (TECH. & NON-TECH.)
 B. NON-RESIDENT CONTRACTORS UNDER WRITTEN CONTRACT OF NON-US CITIZENS OR RESIDENT ALIENS ONLY
 2. THIS FORM IS NOT APPLICABLE FOR OPERATIONAL OR FIELD AGENTS
 3. COPIES OF THE FORM WILL BE RETAINED BY THE ORIGINATING COMPONENT (NUMBER OF COPIES AT ITS DISCRETION) AND BY CSPS/AGENT BRANCH (1 COPY ONLY)

NAME (LAST, FIRST, MIDDLE) BENADUM, Jeremy K. (P)			SEX Male	DATE OF BIRTH <div style="border: 1px solid black; width: 50px; height: 20px;"></div>
MARITAL STATUS Married	NO. DEPENDENTS 6	YEARS OF BIRTH 1917, 48, 50, 51, 57, 59 /	NATIONALITY U. S. A.	LAST MEDICAL EXAM 18 July 1961
DATE OF LATEST SECURITY/OPERATIONAL APPROVAL CSA, 22 December 1960		JOB TITLE Ops Officer		COMPONENT DDP/WH/1
CONTRACT CATEGORY Career Agent	EFFECTIVE DATE 30 Oct 1960	EXPIRATION DATE Indefinite	SALARY \$27,463	GRADE EQUIVALENT GS-15/7
PROJECT OR PAN # 1135-1014		BENEFITS		
SOCIAL SECURITY		YES		
FICA DEATH AND DISABILITY		NO		
ANNUAL AND SICK LEAVE		X		
CIVIL SERVICE RETIREMENT		X		
CIA RETIREMENT OR COMMERCIAL CIA ANNUITY		X		
FEDERAL EMPLOYEES GROUP LIFE AND HEALTH INSURANCE		X		
CONTRACT LIFE AND HEALTH INSURANCE		X		
MISSING PERSONS BENEFITS		X		
OTHER (EXPLAIN) Legislative Pay Increases				

NON-CIA EDUCATION

1936 Pomona College, California, A. B., Political Science
 1939 Stanford University Law School, LL. B., Law
 1940 FBI Academy

DATES FROM - TO	NON-CIA EMPLOYMENT			
	EMPLOYER	LOCATION	FUNCTION	SALARY
1939-40	U. S. Army			
1940-60	FBI	Mexico (1951-60) Peru (1943-47)	Legal Attache	\$13,000

CIA TRAINING

CIA EMPLOYMENT HISTORY (INCLUDING REEF FOD)						
---	--	--	--	--	--	--

DATES FROM - TO	FUNCTION	COSTS (EST.)	LOCATION	PROJECT	SALARY	GRADE EQUIV.
Oct 60	Ops Officer (Career Agent)			LITEMPO	13,730	15
Apr 66	"		"	"	19,415	"
Jun 70	"		"	"	27,463	"
31 Dec 1970	<i>Retired</i>					

None.

COVER

A. PRESENT COVER IS: OFFICIAL NON-OFFICIAL

GENERAL EVALUATION OF COVER SECURITY:

[Redacted]

EVALUATION OF PERFORMANCE:

The Station has consistently rated Subject's performance as "strong".

ADAPTABILITY (SUBJECT AND FAMILY) TOWARDS DUAL LIFE

[Redacted]

(Subject has been employed in this same position for approximately ten years.) Subject's wife has a full schedule of activities surrounding her family and community. She is discreet and is not the type of woman who feels that she has to know and approve of her husband's every move.

B. PREVIOUS COVER WAS: OFFICIAL NON-OFFICIAL (GIVE BRIEF DESCRIPTION IF N/A)

N/A. [Redacted]

[Redacted] Prior to Agency employment, he was employed by the FBI in Mexico.

MOBILITY

INDICATE LIMITING FACTORS BOTH PERSONAL AND OPERATIONAL

N/A. Subject will retire from Agency employment this year.

FUTURE UTILIZATION

INDICATE PLANS OR RECOMMENDATIONS FOR USE AFTER CURRENT ASSIGNMENT

There are no plans to use Subject's services after his retirement.

SECRET

SECRET

1. PERM. SERIAL NO.		SIGGRAPHIC PROFILE (PART I) SCD: ?			
2. NAME (Last-First-Middle)		3. DATE OF BIRTH		4. CONTRACT EMP. DATE	
BENADUM, Jeremy V. (P)		1950		?	
5. MARITAL STATUS	6. DEPENDENT (Include all dependents)	7. YEARS OF BIRTH	8. US NATURALIZATION CATEGORY		
Married		6 1917 1948 1950 1951 1957	NA	?	
9. CAREER STAFF STATUS	10. MEMBERSHIP	11. OTHER STAFFS	12. LAST MO. EMP.	13. QUAL. FOR	14. TEST FOR
		Ineligible	Jul 1961	Prop Assign	From Assign
15. CURRENT RESERVE STATUS	16. NON-CIA SERVICE	17. GRADE	18. ACTIVE WITH CIA CAT. 1	19. RELEASE TO MIL. SER. CAT. 2	20. TO BE OFFERED CAT. 3
	X				
21. ASSESSMENT DATE		22. PROFESSIONAL TEST DATE		23. LANGUAGE APTITUDE TEST DATE	
24. NON-CIA EMPLOYMENT					
7 Military Service, US Army, 1st Lt 19 7-60 FBI - 20 years					
25. NON-CIA EDUCATION					
26. FOREIGN LANGUAGE ABILITIES (Language, Proficiency, Date Tested)		27. FOREIGN LANGUAGE ABILITIES			
		Spanish - S,W,R Fluent German - S,R Slight French - S,R Slight			
28. AGENCY SPONSORED TRAINING					
None					
29. CIA EMPLOYMENT HISTORY SINCE 30 SEPT 1949 (Personnel Actions, Military Orders, and Principal Details)					
30. EFFECTIVE DATE	31. POSITION TITLE & OCCUPATIONAL CODE	32. GRADE	33. ID	34. ORGANIZATION & ORGAN. TITLE (If any)	35. LOCATION
Oct 1960	CE Ops Off (Career Art)	\$1370 GS15		DDP/AM/LITZPO	
Apr 1966	" " " " " "	\$2815	15	" " "	" " "
36. DATE REVIEWED		37. PROFILE REVIEWED BY		38. ITEMS 1 TO 20 OBJECTED TO BY EMPLOYEE	
19 Sep 1967		na		No	

SECRET
(When Filled In)

PERS. SERIAL NO.	BIOGRAPHIC PROFILE (PART 2)	
NAME (Last-First-Middle)		DATE OF BIRTH
BENADIM, Jerome V. (P)		
22. No Fitness Report in Official Personnel Folder. Subject's EOD date as CA is Oct 1966. No Photo Available.		
24. SUMMARY OF CAREER PREFERENCE OUTLINE AND/OR FIELD REASSIGNMENT QUESTIONNAIRE		
28. IDENTITY OF OTHER DOCUMENTS WHICH SHOULD BE REVIEWED IN DETAIL		
26. ADDITIONAL INFORMATION		
27. DATE REVIEWED	28. PROFILE REVIEWED BY	
19 Sep 1967	he	

DISPATCH		CLASSIFICATION SECRET RYBAT	PROCESSING ACTION
TO	Chief, WH Division	XXX	MAILED FOR INDEXING
INFO.			NO INDEXING REQUIRED
FROM	Chief of Station 		ONLY QUALIFIED DESK CAN JUDGE INDEXING
SUBJECT	ADMIN/PERS Transmittal of Memorandum in Lieu of Fitness Report - Jeremy K. BENADUM		MICROFILM
ACTION REQUIRED - REFERENCES			
<p>Attached herewith are three copies of a Memorandum in lieu of a Fitness Report on Jeremy K. BENADUM.</p> <div style="border: 1px solid black; width: 200px; height: 50px; margin: 20px auto;"></div>			
<p>Attachment: Memorandum h/w</p> <p>Distribution: Orig & 2 - C/WHID w/att h/w</p>			
CROSS REFERENCE TO	DISPATCH SYMBOL AND NUMBER HSMIT-10432	DATE 21 July 1970	
	CLASSIFICATION SECRET RYBAT	NOT FILE NUMBER	

21 July 1970

MEMORANDUM IN LIEU OF FITNESS REPORT

SUBJECT: Cover Agent Jeremy K. BENADUM

During the past three months I have had the opportunity to work with and direct the activities of Jeremy K. BENADUM. Within a few months he will be retired from further service and it is appropriate now to review his past performance and present status in order that this remain a permanent part of his record.

BENADUM, during the past ten years, has performed as the outside case officer for the LITEMPO Project. He was pressed into service after resigning his position with LNERGO, for whom he worked for a period of twenty years.

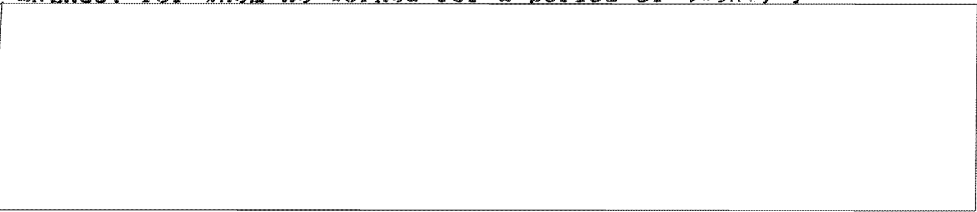

His past evaluations are still valid, however, during the past three months he has gradually been phased out of

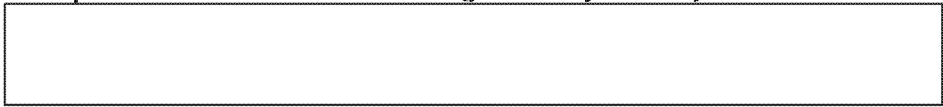

Although his retirement is not voluntary, he has good-naturedly assisted the Station in this very sensitive and delicate changeover. He will [redacted] after his retirement and has offered his assistance if needed. He

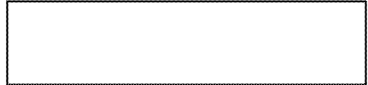

S-E-C-R-E-T

Date 20 August 1962

Career Agent Biographic Data

- a. Pseudonym of agent: ROXANNE Jeremy K. Staff or Division: WED
Last First MI
- b. Date and place of birth:
- c. Marital status: **Married**
- d. Relationship and years of birth of dependents:
- e. Citizenship of agent: **USA**
(1) If naturalized, when?
(2) If naturalized, where?
- g. Non-CIA education to include name and location of college, degrees, dates, and major:
Pomona College, Claremont, California, A.B. 1936, Political Science
Stanford Univ Law School, LL.B. 1939, Law
FBI Academy, August, September 1940
- h. Military service: **Thomason Act Training, Infantry School, Oct 1939-July 1940**
(1) Country served and years:
(2) Branch of service and rank:
- i. Non-CIA employment: kinds of business or profession, positions, salaries, locations, and dates:
FBI - Aug 1940-Sept 1960, GS-14, \$13,000/year when resigned,
Assistant Legal Attache, US Embassy, Lima, Peru, 1943-45
Legal Attache same post, 1946-47
Assistant Legal Attache, Mexico City, 1951-60
Deputy to Legal Attache 1957-60

S-E-C-R-E-T

Group I
Excluded from automatic
downgrading and declassification

S-E-C-R-E-T

(Career Agent Biographic Data p. 2)

j. Dates of psychological assessment, professional and language aptitude tests, if applicable:
Not applicable

k. Languages, including English, using the following terms:
Elementary, Intermediate, High, Native

<u>Language</u>	<u>Reading</u>	<u>Writing</u>	<u>Speaking</u>
Spanish	high	high	high
English	native	native	native
German	intermediate	none	intermediate
French	elementary	none	elementary

l. Agency training:

<u>Subject Covered</u>	<u>Duration of Course</u>	<u>Years Taken</u>
not applicable		

m. Alias or pseudonym used for psychological assessment, testing or training, if applicable:
not applicable

n. Security clearance number: CSA, 22 December 1960 - S-11403

o. Date of last LCFLUTTER: None

p. Contract provisions: (Underline One)

(1) Provision for periodic step increases	<u>Yes</u>	No
(2) Provision for legislative pay increases	<u>Yes</u>	No
(3) Provision for total offset of cover income	<u>Yes</u>	No
(4) Provision for civil service retirement	<u>Yes</u>	No
(5) Any unusual provisions (please specify)		

S-E-C-R-E-T

(Career Agent Biographic Data p. 3)

q. Date of beginning of current tour: 30 October 1960

r. Previous CIA employment:

<u>Years</u>	<u>Type of Cover</u>	<u>CIA Duties</u>	<u>Project</u>	<u>City</u>	<u>Salary</u>
--------------	----------------------	-------------------	----------------	-------------	---------------

None

S-E-C-R-E-T

SECRET

MEMORANDUM FOR: Director of Personnel

SUBJECT : Jeremy K. BENADUM, Terminal
Annual Leave

REFERENCE : HR 20-30 c (4)

1. It is requested that approval be granted for Jeremy K. BENADUM, Career Agent, to use accumulated annual leave prior to his retirement on 31 December 1970.

2. BENADUM has been assigned PCS to [redacted] and will retire in place. He has a maximum leave carryover of 560 hours plus leave accrued during 1970. BENADUM's request that he be permitted to use accrued annual leave in lieu of a lump-sum payment was endorsed by the [redacted] Station.

3. The Chief of Station, prior to departure for [redacted] recommended that BENADUM's request be approved. This was based on operational considerations which are in the best interests of the Agency for there to be an amicable separation when BENADUM retires.

4. The WH Division recommends favorable consideration be accorded this request.

William V. Broo
Chief
Western Hemisphere Division

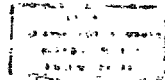

SECRET

- 2 -

SUBJECT: Jeremy K. BENADUM, Terminal Annual Leave

CONCUR:

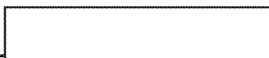
DDP/NSP

APPROVED:

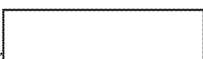
Director of Personnel

21 JUL 1970

DDP/WH/Contracts:WSRonehan:aid (20 July 1970)

Distribution: Orig - WH/Contracts
1 - Addressee
1 - DDP/NSP
1 - CPD
1 - WH/1

SECRET

SECRET		SECRET		<input type="checkbox"/> DIRECTOR'S OFFICE <input type="checkbox"/> ASST. DIR. FOR AD. AFF. (A) <input type="checkbox"/> ASST. DIR. FOR INT. SEC. (I) <input type="checkbox"/> ASST. DIR. FOR IDENT. (ID) <input type="checkbox"/> ASST. DIR. FOR INSP. (IN) <input type="checkbox"/> ASST. DIR. FOR LAB. (L) <input type="checkbox"/> ASST. DIR. FOR LEG. AFF. (LA) <input type="checkbox"/> ASST. DIR. FOR PLAN. & ADM. (P) <input type="checkbox"/> ASST. DIR. FOR RESEARCH & DEV. (RD) <input type="checkbox"/> ASST. DIR. FOR TECH. SER. (TS) <input type="checkbox"/> ASST. DIR. FOR TRAINING (T) <input type="checkbox"/> ASST. DIR. FOR COMM. (C) <input type="checkbox"/> ASST. DIR. FOR CRIM. INV. (CI) <input checked="" type="checkbox"/> CHIEF OF BUREAU <input type="checkbox"/> ASST. TO DIR. (ATD) <input type="checkbox"/> ASST. TO DIR. (ATD) - AD. AFF. (A) <input type="checkbox"/> ASST. TO DIR. (ATD) - INT. SEC. (I) <input type="checkbox"/> ASST. TO DIR. (ATD) - IDENT. (ID) <input type="checkbox"/> ASST. TO DIR. (ATD) - INSP. (IN) <input type="checkbox"/> ASST. TO DIR. (ATD) - LAB. (L) <input type="checkbox"/> ASST. TO DIR. (ATD) - LEG. AFF. (LA) <input type="checkbox"/> ASST. TO DIR. (ATD) - PLAN. & ADM. (P) <input type="checkbox"/> ASST. TO DIR. (ATD) - RESEARCH & DEV. (RD) <input type="checkbox"/> ASST. TO DIR. (ATD) - TECH. SER. (TS) <input type="checkbox"/> ASST. TO DIR. (ATD) - TRAINING (T) <input type="checkbox"/> ASST. TO DIR. (ATD) - COMM. (C) <input type="checkbox"/> ASST. TO DIR. (ATD) - CRIM. INV. (CI)	
TO	Chief, WH Division	XX			
FROM	Chief of Station, Mexico City				

SUBJECT: LITEMPO/Jeremy K. BENADUM - Agent Evaluation

ACTION REQUIRED: For Your Information

REFERENCES : A. HMMA-32877, 28 August 1967
 B. DIRECTOR-99063

1. In accordance with the request made in Reference B, the following is an up-dated Agent Evaluation on Jeremy K. BENADUM, Career Agent and outside Case Officer for the LITEMPO Project. This evaluation should be considered in conjunction with Reference A, which is still valid and more extensive.

2. BENADUM continues to perform as the Outside Case Officer for the LITEMPO Project in a professional and efficient manner.

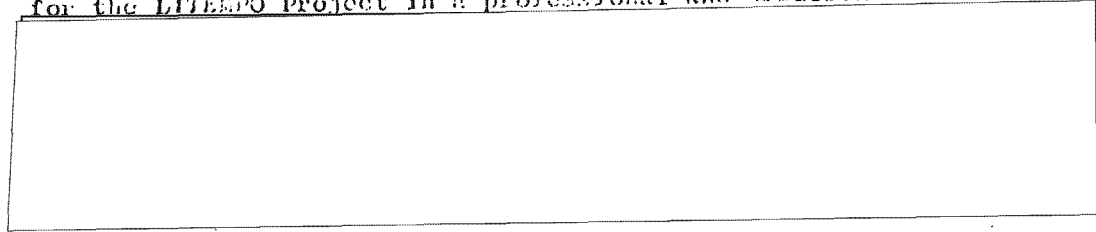

Continued.....

Distribution:
 Orig and 2 - Chief, WHD

CLASSIFICATION	SECRET HMMA-37320	DATE	10 June 1969
	SECRET	FILE NO.	201-287227

[Redacted]

4. BENADUM writes well and has improved considerably in providing information he obtains from his contacts in written form. Usually, the reports he submits need little editing in order to be processed for dissemination.

[Redacted]

[Redacted]

Based upon the Regular Fitness Report system, this Officer could be rated as STRONG in judging his performance.

[Redacted]

8. BENADUM was shown this evaluation in draft form.

[Redacted]

SECRET

(When Filled In)

NOMINATION AND DESIGNATION OF PARTICIPANT
CIA RETIREMENT AND DISABILITY SYSTEM

SECTION A

STATUS OF EMPLOYEE

1. SERIAL NUMBER 00885 (Of (nyrol) No.)	2. NAME (Last-First-Middle) BENNETT, Jeremy K.	3. DATE OF BIRTH	4. SSN	5. EMPLOYMENT CATEGORY (Refer to R 20-2) Career Agent
6. CURRENT OCCUPATIONAL TITLE Operations Officer		7. GRADE GS-13 equiv.	8. OFFICE OF ASSIGNMENT WII	
9. ASSIGNMENT LOCATION <input type="checkbox"/> DEPARTMENTAL <input type="checkbox"/> U.S. FIELD <input checked="" type="checkbox"/> FGN. FIELD		10. LONGEVITY COMPUTATION 0975 October 1960	11. SERVICE COMPUTATION 7041 October 1939	

SECTION B

PERFORMANCE OF QUALIFYING SERVICE

1. Has this employee completed any qualifying service? YES NO. If "Yes", list periods of such service below

INCLUSIVE DATES (From-To)		OCCUPATIONAL TITLE	LOCATION WHERE SERVICE PERFORMED (City-County or State)	CHECK OFF		TOTAL TIME	
MONTH/DAY/YR	MONTH/DAY/YR			PCS	TOY	MONTH	DAYS
Oct. 30 '60	present	Operations Officer	Mexico City	X		106	

2. Is this employee currently performing qualifying service? YES NO. If "Yes", complete the following:

BEGIN DATE	END DATE	OCCUPATIONAL TITLE	LOCATION	PCS	TOY	MONTHS	DAYS

3. If employee was assigned in the United States during any period of qualifying service listed above, describe his duties below, pointing out those conditions which meet the requirements of QUALIFYING SERVICE.

4. Is this employee currently on official orders for a PCS assignment requiring the performance of qualifying service? YES NO. If "Yes", attach a certification to this effect.

5. CERTIFICATION - The information furnished above has been verified against official Agency records. Where no official record was available, a supporting statement is attached.

6. TYPED NAME AND TITLE OF CAREER SERVICE APPROVING OFFICIAL	7. SIGNATURE	8. DATE
--	--------------	---------

Continued on Reverse Side

SECRET

(When Filled In)

STATUS OF SERVICE AGREEMENT

SECTION C

(TO BE COMPLETED BY CAREER SERVICE APPROVING OFFICIAL)

- Form 3101, Service Agreement, is attached.
- Because of temporary absence of the nominee, Form 3101, Service Agreement, will be forwarded at a later date.
- (1) Nominee has over 15 years of Agency service or (2) nominee cannot be readily contacted to sign a Service Agreement. The signed "Application for Membership in the Career Staff of the CIA" on file in the nominee's Official Personnel Folder should be accepted in lieu of Form 3101, Service Agreement.
- Nominee is overseas and a signed "Application for Membership in the Career Staff of the CIA" is NOT filed in his Official Personnel Folder. Form 3101, Service Agreement, will be requested from the field upon notification that the CIA Retirement Board has recommended approval of his nomination.

SECTION D

RECOMMENDATION OF HEAD OF CAREER SERVICE

1. Based on his career assignment and past and prospective performance of qualifying service, this employee is recommended for designation as a participant in the CIA RETIREMENT AND DISABILITY SYSTEM. He is serving in a career field which normally requires the performance of qualifying service as an integral part of a career in that field.

2. TYPED NAME AND TITLE	3. SIGNATURE OF HEAD OF CAREER SERVICE	4. DATE
-------------------------	--	---------

SECTION E

RECOMMENDATION OF CIA RETIREMENT BOARD

1. The record of this employee has been reviewed and the CIA RETIREMENT BOARD has recommended on _____ (DATE) that this employee:

- be designated as a participant in the CIA RETIREMENT AND DISABILITY SYSTEM
- NOT be designated as a participant

2. TYPED NAME AND TITLE	3. SIGNATURE	4. DATE
-------------------------	--------------	---------

SECTION F

DETERMINATION BY DIRECTOR OF PERSONNEL

1. In accordance with Regulation 20-50, this employee is DESIGNATED NOT designated a participant in the CIA Retirement and Disability System.

2. SIGNATURE OF DIRECTOR OF PERSONNEL

3. DATE

SECTION G

ADDITIONAL INFORMATION

I certify that the information in Section _____ is to the best of my knowledge _____

FORM 110

SECRET

20 August 1962

SUBJECT: Assessment of Career Agent, Jeremy K. BENADUM

1. Pseudonym and salary: Jeremy K. BENADUM, GS-15, \$14,055.
2. Division or Staff and city: WH Division,
3. Operational duties:

5. Division's assessment: Subject is an experienced, well-trained, serious intelligence officer, capable of spotting, assessing, recruiting and handling agents. Most of his experience and capability is in the field of collection of FI intelligence and operational support, the latter being his most outstanding area of contribution to Station objectives. He would also be capable of running CI operations. His knowledge of CA type work, however, cannot be assessed at Headquarters.

Subject's cover is a natural one and poses no difficulties. Since Subject has been in the intelligence field for over 20 years, he is psychologically prepared for his dual role in intelligence operations and is well qualified to operate without strong Station support.

Headquarters is not in a position to comment on the timeliness or quality of his operational reporting, but no defects in this regard have been noted nor have any been brought to the attention of Headquarters by the Station.

Subject needs no training.

SECRET

Chief of Station [redacted]

NO INDEXING REQUIRED
ONLY QUALIFIED DESK
CAN JUDGE INDEXING

Chief, WH Division

ADMIN/CONTRACTS

Jeremy K. BENADUM - Retirement, Report of [redacted]

Reference: [redacted] 3340

1. Reference indicated Jeremy K. BENADUM had proposed an extension of his retirement from 31 October to an appropriate date in December 1970 in order for him to use his annual leave in lieu of lump sum payment.

2. Shortly before the COS left Headquarters [redacted] a meeting was held during which the Branch Chief discussed contract personnel of the Station.

Ref was discussed and it was the COS's desire for there to be an amicable separation at the time of BENADUM's retirement. If, therefore, the extra two months would accomplish this, then the added costs would be worthwhile.

3. The following annuity figures have been provided by the Retirement Office and are predicated on a retirement date of 31 December 1970. Please keep in mind, the figures must be considered as estimates and subject to verification of service and final computations. Retirement would be under the Organization Program.

(Continued)

Attachment : As stated, herewith

Distribution: 2-COS, [redacted]

CROSS REFERENCE TO	DISPATCH SYMBOL AND NUMBER	DATE
	HMMS-6919 CLASSIFICATION	22 JUL 1970
	SECRET	MOS FILE NUMBER
	OFFICE	EST
	WH/Contracts (WSK:encl:in me 16 Jul 70)	4460
	COORDINATING	
	OFFICE SYMBOL	DATE
	C/WH/1	16/7/70
	C/WH/1	16/7/70
	OFFICE SYMBOL	DATE
	C WH SS	22/Jul/70
	BY	SIGNATURE
	[redacted]	Richard B. Wright

1-WH/1
1-WH/Regist
1-WH/Contract
1-WH/PA [redacted]

Annuity Without Survivor Benefit	\$15,726 pa	\$1,311 pm
Annuity With Survivor Benefit	14,424 pa	1,202 pm
Survivor Annuity (maximum)	8,649 pa	721 pm

High Three Average Salary \$24,445

Creditable Service			
Service	31 yrs.	1 month	24 days
*Sick Leave Credit		2,232 hours	
Total	32 yrs.	2 months	
*Carryover into 1970		2,128 hours	
Accrual in 1970		104 hours	
Total		2,232 hours	

(Note: The leave figures are on the basis that he has not taken any sick leave during 1970.)

4. The Retirement Office also advised that in order for BENADUM to be accorded use of his accumulated annual leave he should begin the leave on fourteen (14) August. This is based on his carryover into 1970 of 560 hours and his accrual during 1970. The figures are on the basis that no leave other than that reported to Headquarters has been taken.

5. In order to start the retirement processing, the following actions should be effected by the Station and the papers concerned returned to Headquarters, Attention, WH/Contracts.

a. Contract Amendment

Attached is the original and one copy of an amendment effective 24 August 1969 to BENADUM's contract which provides for his participation in the Organization Retirement Program.

The original and copy are to be signed by BENADUM. The copy is for Station retention.

b. Retirement Request

BENADUM is to submit a signed memo requesting approval for him to retire 31 December 1970. The request should be concurred with by the COS by the use of a concurrence line on the memo.

c. Military Service

Please obtain from BENADUM a copy of his discharge from the military service for transmittal to Headquarters. In the event he does not have the paper readily available, please do not delay transmittal of "a" and "b" above.

Upon receipt in Headquarters of the above papers, they will be processed by and thru offices concerned. The Retirement Office will, after completing service verification, etc., forward a dispatch which will provide BENADUM with detailed retirement type info including insurances.

6. Report of

STATION ACTION:

DISPATCH

CLASSIFICATION
SECRET/RYBAT

PENDING ACTION

TO
Chief, WH Division

XXX

MARKED FOR INDEXING

NO INDEXING REQUIRED

INFO.

ONLY QUALIFIED DESK
CAN JUDGE INDEXING

FROM

Chief of Station

MANUAL

SUBJECT **ADMIN/PERS**

Transmittal of Memorandum in Lieu of Fitness Report - Jeremy K. BENADUM

ACTION REQUIRED - REFERENCES

Attached herewith are three copies of a Memorandum in lieu of
a Fitness Report on Jeremy K. BENADUM.

Attachment:
Memorandum h/w

Distribution:
Orig & 2 - C/WHD w/att h/w

Rec'd 31 July 70
1 - W/H
1 - W/H
1 - W/H
 10 Aug 70

FORM 104-1 (10)

FORM 104-1 (10)

DATE

HMFT-10432

21 July 1970

CLASSIFICATION

FORM 104-1 (10)

SECRET/RYBAT

21 July 1970

MEMORANDUM IN LIEU OF FITNESS REPORT

SUBJECT: Cover Agent Jeremy K. BENADUM

During the past three months I have had the opportunity to work with and direct the activities of Jeremy K. BENADUM. Within a few months he will be retired from further service and it is appropriate now to review his past performance and present status in order that this remain a permanent part of his record.

BENADUM, during the past ten years, has performed as the outside case officer for the LITEMPO Project. He was pressed into service after resigning his position with LNERGO, for whom he worked for a period of twenty years.

His past evaluations are still valid, however, during the past three months he has gradually been phased out of

Although his retirement is not voluntary, he has good-naturedly assisted the Station in this very sensitive and delicate changeover. He will [redacted] after his retirement and has offered his assistance if needed. He

[redacted]

WSRenehan
WH Contracts
4460
18 July 1970

MESSAGE FORM
JULY COPY

19

SECRET

BUILDING NUMBER		CLASS BY	
55	1		
	2		
	3		
	4		
	5		
	6		
	7		
	8		
	9		
	0		

CLASSIFICATION INDEX NO INDEX RETURN TO BRANCH FILE RID

FILE IN CS FILE NO.

FILE NO. 4460 FILE VII. 002 OF 2, PCS2, CS2, F12.

SECRET

17 23 532 JUL 70

CITE DIRECTOR

7051789 7

[Redacted]

ADMIN CONTRACTS

REFS: A. [Redacted] 3577 (IN114008)

B. HMMS-6919

FOUCHING REF B ²²17 JULY CONTAINING LEAVE AND ANNUITY INFO FOR JEREMY K. BENADUM.

END OF MESSAGE

- WH COMMENTS:
- a. Requested annual leave and retirement dates for Subject.
 - b. Transmittal of requested info.

COORD: C/WH/I [Redacted]

C/WH/FL [Redacted]

[Redacted]

WILLIAM V. BROE
C/WH/D

[Redacted]

[Redacted]

WILLIAM S. RENEHAN
C/WH/CONTRACTS

COORDINATING OFFICERS

RELEASED OFFICER

SECRET

GROUP 1
EXCLUDED FROM AUTOMATIC
DOWNGRADING AND
DECLASSIFICATION

AUTHORIZING OFFICER

REPRODUCTION BY OTHER THAN THE ISSUING OFFICE IS PROHIBITED.

COPY NO.

TO: WSBenehan
INFO: WSBenehan
REF: 4469
DATE: 2 JULY 1970

SECRET		11	
1	2	3	4
5	6	7	8
9	10	11	12

ABLE SECRETARIAT DISSEMINATION INDEX NO INDEX RETURN TO _____ BRANCH FILE RID

FILE IN CS FILE NO. _____

CLASS. BY: WJH/8
 (classification) (date) (initials)
 (reference number)

SECRET 32 21 37z JUL 70 CITE DIRECTOR 048159

[Redacted]

ADMIN CONTRACTS

REF: [Redacted] 577 (IN 114008)

POUCHING DETAILS
 END OF MESSAGE

WH COMMENT: Requested annual leave and retirement dates for Jeremy K. BENADUM.

COORD: C/WH/1 [Redacted]

[Redacted]

WILLIAM V. BROE
 C/WH

[Redacted]

WILLIAM S. BENEHAN
 C/WH/CONTRACTS

SECRET

PERSONNEL INFORMATION		GROUP 1		1	5
ADVANCE COPY <input type="checkbox"/> ISSUED <input type="checkbox"/> RETURNED		SECRET (When Filled In)		2	6
DTI _____		REPRODUCTION OF THIS COPY PROHIBITED		3	7
DISSEM BY <u>28</u> PER _____		INDEX: <input type="checkbox"/> YES <input type="checkbox"/> NO		4	8
ACTION UNIT		CLASSIFY TO CS FILE NO. _____			
ACTION NO. <u>214</u>		KEEP TO CS FILE NO. _____			
<u>WII'S</u> FILE, VR <u>OPA</u>		<input type="checkbox"/> FILE NO. <input type="checkbox"/> RETURN TO _____		BRANCH _____	

SECRET DIRECTOR JUL 70 CITE [] 3577 ([] ACTING)

DIRECTOR

ADMIN PERS CONTRACTS

1 JUL 1 14008

REF: [] 3340 (1N095219)

IN ORDER FIRM UP ANNUAL LEAVE AND RETIREMENT DATES, REQUEST ANSWER TO REFERENCE SOONEST. GP-1

SECRET

1 JUL 1970

SECRET

CABLE SECRETARIAT DISSEMINATION

CLASSIFIED MESSAGE

TOTAL COPIES 16

WORKING AREA FOR INITIALS SEE

ADVANCE COPY ISSUED SLOTTED

SECRET
(When Filled In)
REPRODUCTION OF THIS COPY PROHIBITED
INDEX YES NO

1	5
2	6
3	7
4	8

BY: _____ DATE: _____ Z

CLASSIFY TO CS FILE NO. _____

A REF TO CS FILE NO. _____

CLASSIFIED BY 23 PER _____

FILE IN RETURN TO BRANCH

ACTION OF: *e/wah 8* FILE, VR *D/OP, e/ces 2, e/ces ps, 4/F12*
ACTION NO: *698*

SECRET 021912Z JUN 70 CITE [] 3340 ([] ACTING)

DIRECTOR

2 JUN 70 085219

RYBAT ADMIN PERS CONTRACTS

dr

REF: ED-7451

1. STATION DISCUSSED REFERENCE WITH JEREMY K. BENADUM WHILE BOTH UNDERSTAND HE NOT ELIGIBLE UNDER PREFERRED JKLANCE RETIREMENT UNTIL 31 OCTOBER 73. BENADUM PROPOSED EXTENSION OF RETIREMENT TO APPROPRIATE DATE IN DECEMBER 1970 IN ORDER USE 560 HOURS CARRYOVER PLUS UNUSED ACCRUAL DURING CURRENT YEAR IN LIEU LUMP SUM PAYMENT.

2. WITH HEADQUARTERS CONCURRENCE ABOVE, PLEASE FORWARD RETIREMENT PACKAGE AND ADVISE REVISED RETIREMENT DATE, DATE WHICH HE CAN BEGIN LEAVE AND ANNUITY UNDER SURVIVORSHIP PLAN.

3. BENADUM CLAIMED NEVER USED ANY SICK LEAVE AND REQUESTED CONFIRMATION BALANCE 11 JAN 70. GP-1

SECRET

C
DC
RF
27

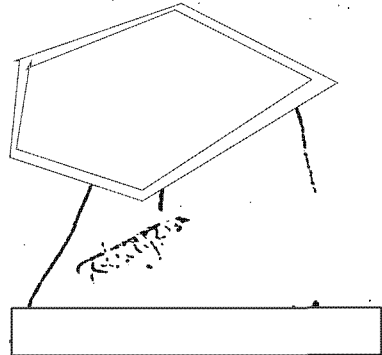
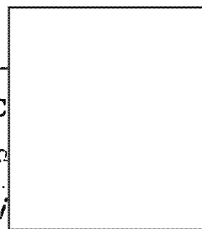

Cancel Request

1. SERIAL NO.		2. NAME		3. ORGANIZATION		4. FUNDS		5. LWOP HOURS	
		BENADUM JEREMY K		WM		CF			
6. OLD SALARY RATE				7. NEW SALARY RATE				8. TYPE ACTION	
Grade	Step	Salary	Last Eff. Date	Grade	Step	Salary	EFFECTIVE DATE	SI	ADJ.
15	6	25189	042168	15	7	25909	041970	X	
CERTIFICATION AND AUTHENTICATION									
I CERTIFY THAT THE WORK OF THE ABOVE NAMED EMPLOYEE IS OF ACCEPTABLE LEVEL OF COMPETENCE.									
SIGNATURE					DATE				
					12/1/70				
<input type="checkbox"/> NO EXCESS LWOP <input type="checkbox"/> IN PAY STATUS AT END OF WAITING PERIOD <input type="checkbox"/> LWOP STATUS AT END OF WAITING PERIOD									
CLERK'S INITIALS					AUDIT				
FORM 7-65 560 E		Use previous editions		PAY CHANGE NOTIFICATION				(4.3)	

25 MAR 76
L-1

Chief of Station, [redacted]

Chief, WH Division
ADMIN/CONTRACTS

Jeremy K. BENADUM, Quarters Allowance

Reference: HMMT-10052

1. Reference asked Headquarters guidance in determining possible adjustment in the Quarters Allowance for Jeremy K. BENADUM, Career Agent. Reference stated:

--BENADUM purchased his local residence 1 December 1964 for \$50,200 and cost of utilities average \$98 monthly.

--Although the current maximum Quarters Allowance for BENADUM is \$4,700 per annum, the Station has been paying at the rate of \$4,128.96 per annum.

--Reference forwarded a list of BENADUM's estimates of utilities costs and a LNPURE memo on personally owned quarters.

2. The formula described in Para 3 of the LNPURE memo has been used in prior cases and is that which is also used by the Allowance Committee. Based on this formula, 10% of \$50,200 (original purchase price) plus \$1,176 (yearly utilities), total \$6,196. The amount granted BENADUM would presumably be the maximum unless the Station had determined a lesser rate was applicable due [redacted]

3. Using the effective date (5 October [redacted]) of the current Quarters Allowance rate \$4,700 (\$4,100 plus \$600 for dependents) minus the rate being paid, \$4,128.96 represents an increase of \$571.04 per year or \$47.58 per month.

(continued)

Distribution: 2-COS [redacted]

CROSS REFERENCE TO	OPERATION SYMBOL AND NUMBER	DATE
	HMMT-6769	2 1/2
CLASSIFICATION	SECRET	WHS FILE NUMBER
OFFICE	ORIGINATOR	DATE
	WH Contracts WSRonchag me (19 March 70)	4460
CLASSIFICATION	CLASSIFICATION	CLASSIFICATION
	C/WIL B&E	C/WIL T
CLASSIFICATION	CLASSIFICATION	CLASSIFICATION
CLASSIFICATION	CLASSIFICATION	CLASSIFICATION
	AC WH 55	[redacted]

1-C WH/B&F
1-C WH/T
1-WH Registry
1-WH Contracts

DISPATCH

For the period 1 December - 31 March
BENADUM was paid quarters at the rate of \$4,024.92 although
the maximum allowance was \$3,700 per annum. For the four
months, BENADUM was overpaid \$102.26 (\$27.07 x 4).

Presuming the project has sufficient funds and the
COS decides the maximum rate is applicable, the overpayment
is to be offset against the increase.

6 FEB 1970

MEMORANDUM FOR : **Jeremy K. BENADUM**
THROUGH : Head of Career Service
SUBJECT : Retirement Planning

1. In order to assist employees in planning for their eventual retirement, it is the practice of the Agency to notify each employee at a point in service five years prior to the date of scheduled retirement. I am, therefore, taking this opportunity to advise you that you are scheduled to retire in August 1975.

2. The prospect of retirement from the Agency deserves serious thought and careful planning so that you may make the transition to the next phase of life with purpose and confidence. To assist you in this regard, the Agency will make available to you various resources which are attuned to the needs of prospective retirees. In October 1970, the Agency will conduct a Retirement Information Seminar to which you will be invited. Your spouse, if you are married, may accompany you to this seminar. Following the seminar, you will be invited by the Retirement Counselor for your Directorate to an individual pre-retirement counseling session (or more than one, if you wish); this phase of retirement planning will be tailored solely to your own particular situation and circumstances and will be within the context of the retirement system under which you will retire. The individual counseling sessions are intended to give you a wide range of information on such matters as estimates of your annuity, survivor benefits, life and health insurance, Social Security, taxes, relocation and movement of household effects and assistance in obtaining other employment, if appropriate. In addition to the sessions with your Retirement Counselor, you will be invited to avail yourself of selected literature on all aspects of retirement.

3. Some persons who wish to retire voluntarily prior to the scheduled date, or who wish to commence their planning as early as possible, prefer to work with their Retirement Counselor well before the time he would normally contact them. If you believe you would benefit from such an earlier start on your personal planning, you are invited to contact the Retirement Counselor responsible for your Directorate. He is assigned from your Directorate to the Retirement Affairs Division, 212 Magazine Building in Rosslyn, on telephone extension 3328.

4. Experience has amply demonstrated that careful planning facilitates the transition to retirement. I recommend, strongly, that you avail yourself of the services the Agency offers you in planning your own retirement.



Robert S. Wattle
Director of Personnel

DISPATCH

CLASSIFICATION
SECRET

PROCESSING ACTION

TO

Chief, WII Division

X

MARKED FOR INDEXING

INFO.

NO INDEXING REQUIRED

FROM

Chief of Station, Mexico City *HSA*

ONLY QUALIFIED DESK

CAN JUDGE INDEXING

MICROFILM

SUBJECT

ADMIN/FINANCE

Jerome K. BENADUM - Living Quarters Allowance

ACTION REQUIRED - REFERENCES

Action Required: Paragraph 3.

1. Subject purchased his local residence in Mexico City on 1 December 1964 at a cost of \$50,200.00 and has been residing in it since that date. Station has paid BENADUM a quarters allowance as follows:

1 December 1964 to 31 March 1965 - \$4,024.92 per annum
1 April 1965 to present - \$4,128.96 per annum.

A review of subject's quarters accounting for the period 1 April 1965 to 31 [redacted] 1965 reflect his average monthly utilities costs at \$36.00. (See Attachment A.)

2. Subject's basic quarters allowance has been as follows:

1 December 1964 - \$3,770.00 per annum
25 April 1965 - \$4,300.00 per annum (*)
16 July 1967 - \$4,400.00 per annum
14 July 1968 - \$4,500.00 per annum
[redacted] 1969 - \$4,700.00 per annum.

(*) Effective date of family plan.

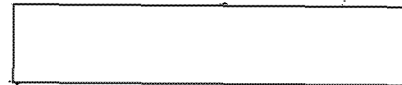

Attachments:

A - QRS 4024 - 1/6
B - [redacted] memo - 1/67

Distribution:

(1) - W/MS w/attch

Benadum - Living Quarters Allowance
1/65 - 1/67
1/67 - 1/68
1/68 - 1/69
1/69 - 1/70
1/70 - 1/71
1/71 - 1/72
1/72 - 1/73
1/73 - 1/74
1/74 - 1/75
1/75 - 1/76
1/76 - 1/77
1/77 - 1/78
1/78 - 1/79
1/79 - 1/80
1/80 - 1/81
1/81 - 1/82
1/82 - 1/83
1/83 - 1/84
1/84 - 1/85
1/85 - 1/86
1/86 - 1/87
1/87 - 1/88
1/88 - 1/89
1/89 - 1/90
1/90 - 1/91
1/91 - 1/92
1/92 - 1/93
1/93 - 1/94
1/94 - 1/95
1/95 - 1/96
1/96 - 1/97
1/97 - 1/98
1/98 - 1/99
1/99 - 1/00
1/00 - 1/01
1/01 - 1/02
1/02 - 1/03
1/03 - 1/04
1/04 - 1/05
1/05 - 1/06
1/06 - 1/07
1/07 - 1/08
1/08 - 1/09
1/09 - 1/10
1/10 - 1/11
1/11 - 1/12
1/12 - 1/13
1/13 - 1/14
1/14 - 1/15
1/15 - 1/16
1/16 - 1/17
1/17 - 1/18
1/18 - 1/19
1/19 - 1/20
1/20 - 1/21
1/21 - 1/22
1/22 - 1/23
1/23 - 1/24
1/24 - 1/25
1/25 - 1/26
1/26 - 1/27
1/27 - 1/28
1/28 - 1/29
1/29 - 1/30
1/30 - 1/31
1/31 - 1/32
1/32 - 1/33
1/33 - 1/34
1/34 - 1/35
1/35 - 1/36
1/36 - 1/37
1/37 - 1/38
1/38 - 1/39
1/39 - 1/40
1/40 - 1/41
1/41 - 1/42
1/42 - 1/43
1/43 - 1/44
1/44 - 1/45
1/45 - 1/46
1/46 - 1/47
1/47 - 1/48
1/48 - 1/49
1/49 - 1/50
1/50 - 1/51
1/51 - 1/52
1/52 - 1/53
1/53 - 1/54
1/54 - 1/55
1/55 - 1/56
1/56 - 1/57
1/57 - 1/58
1/58 - 1/59
1/59 - 1/60
1/60 - 1/61
1/61 - 1/62
1/62 - 1/63
1/63 - 1/64
1/64 - 1/65
1/65 - 1/66
1/66 - 1/67
1/67 - 1/68
1/68 - 1/69
1/69 - 1/70
1/70 - 1/71
1/71 - 1/72
1/72 - 1/73
1/73 - 1/74
1/74 - 1/75
1/75 - 1/76
1/76 - 1/77
1/77 - 1/78
1/78 - 1/79
1/79 - 1/80
1/80 - 1/81
1/81 - 1/82
1/82 - 1/83
1/83 - 1/84
1/84 - 1/85
1/85 - 1/86
1/86 - 1/87
1/87 - 1/88
1/88 - 1/89
1/89 - 1/90
1/90 - 1/91
1/91 - 1/92
1/92 - 1/93
1/93 - 1/94
1/94 - 1/95
1/95 - 1/96
1/96 - 1/97
1/97 - 1/98
1/98 - 1/99
1/99 - 1/00
1/00 - 1/01
1/01 - 1/02
1/02 - 1/03
1/03 - 1/04
1/04 - 1/05
1/05 - 1/06
1/06 - 1/07
1/07 - 1/08
1/08 - 1/09
1/09 - 1/10
1/10 - 1/11
1/11 - 1/12
1/12 - 1/13
1/13 - 1/14
1/14 - 1/15
1/15 - 1/16
1/16 - 1/17
1/17 - 1/18
1/18 - 1/19
1/19 - 1/20
1/20 - 1/21
1/21 - 1/22
1/22 - 1/23
1/23 - 1/24
1/24 - 1/25
1/25 - 1/26
1/26 - 1/27
1/27 - 1/28
1/28 - 1/29
1/29 - 1/30
1/30 - 1/31
1/31 - 1/32
1/32 - 1/33
1/33 - 1/34
1/34 - 1/35
1/35 - 1/36
1/36 - 1/37
1/37 - 1/38
1/38 - 1/39
1/39 - 1/40
1/40 - 1/41
1/41 - 1/42
1/42 - 1/43
1/43 - 1/44
1/44 - 1/45
1/45 - 1/46
1/46 - 1/47
1/47 - 1/48
1/48 - 1/49
1/49 - 1/50
1/50 - 1/51
1/51 - 1/52
1/52 - 1/53
1/53 - 1/54
1/54 - 1/55
1/55 - 1/56
1/56 - 1/57
1/57 - 1/58
1/58 - 1/59
1/59 - 1/60
1/60 - 1/61
1/61 - 1/62
1/62 - 1/63
1/63 - 1/64
1/64 - 1/65
1/65 - 1/66
1/66 - 1/67
1/67 - 1/68
1/68 - 1/69
1/69 - 1/70
1/70 - 1/71
1/71 - 1/72
1/72 - 1/73
1/73 - 1/74
1/74 - 1/75
1/75 - 1/76
1/76 - 1/77
1/77 - 1/78
1/78 - 1/79
1/79 - 1/80
1/80 - 1/81
1/81 - 1/82
1/82 - 1/83
1/83 - 1/84
1/84 - 1/85
1/85 - 1/86
1/86 - 1/87
1/87 - 1/88
1/88 - 1/89
1/89 - 1/90
1/90 - 1/91
1/91 - 1/92
1/92 - 1/93
1/93 - 1/94
1/94 - 1/95
1/95 - 1/96
1/96 - 1/97
1/97 - 1/98
1/98 - 1/99
1/99 - 1/00
1/00 - 1/01
1/01 - 1/02
1/02 - 1/03
1/03 - 1/04
1/04 - 1/05
1/05 - 1/06
1/06 - 1/07
1/07 - 1/08
1/08 - 1/09
1/09 - 1/10
1/10 - 1/11
1/11 - 1/12
1/12 - 1/13
1/13 - 1/14
1/14 - 1/15
1/15 - 1/16
1/16 - 1/17
1/17 - 1/18
1/18 - 1/19
1/19 - 1/20
1/20 - 1/21
1/21 - 1/22
1/22 - 1/23
1/23 - 1/24
1/24 - 1/25
1/25 - 1/26
1/26 - 1/27
1/27 - 1/28
1/28 - 1/29
1/29 - 1/30
1/30 - 1/31
1/31 - 1/32
1/32 - 1/33
1/33 - 1/34
1/34 - 1/35
1/35 - 1/36
1/36 - 1/37
1/37 - 1/38
1/38 - 1/39
1/39 - 1/40
1/40 - 1/41
1/41 - 1/42
1/42 - 1/43
1/43 - 1/44
1/44 - 1/45
1/45 - 1/46
1/46 - 1/47
1/47 - 1/48
1/48 - 1/49
1/49 - 1/50
1/50 - 1/51
1/51 - 1/52
1/52 - 1/53
1/53 - 1/54
1/54 - 1/55
1/55 - 1/56
1/56 - 1/57
1/57 - 1/58
1/58 - 1/59
1/59 - 1/60
1/60 - 1/61
1/61 - 1/62
1/62 - 1/63
1/63 - 1/64
1/64 - 1/65
1/65 - 1/66
1/66 - 1/67
1/67 - 1/68
1/68 - 1/69
1/69 - 1/70
1/70 - 1/71
1/71 - 1/72
1/72 - 1/73
1/73 - 1/74
1/74 - 1/75
1/75 - 1/76
1/76 - 1/77
1/77 - 1/78
1/78 - 1/79
1/79 - 1/80
1/80 - 1/81
1/81 - 1/82
1/82 - 1/83
1/83 - 1/84
1/84 - 1/85
1/85 - 1/86
1/86 - 1/87
1/87 - 1/88
1/88 - 1/89
1/89 - 1/90
1/90 - 1/91
1/91 - 1/92
1/92 - 1/93
1/93 - 1/94
1/94 - 1/95
1/95 - 1/96
1/96 - 1/97
1/97 - 1/98
1/98 - 1/99
1/99 - 1/00
1/00 - 1/01
1/01 - 1/02
1/02 - 1/03
1/03 - 1/04
1/04 - 1/05
1/05 - 1/06
1/06 - 1/07
1/07 - 1/08
1/08 - 1/09
1/09 - 1/10
1/10 - 1/11
1/11 - 1/12
1/12 - 1/13
1/13 - 1/14
1/14 - 1/15
1/15 - 1/16
1/16 - 1/17
1/17 - 1/18
1/18 - 1/19
1/19 - 1/20
1/20 - 1/21
1/21 - 1/22
1/22 - 1/23
1/23 - 1/24
1/24 - 1/25
1/25 - 1/26
1/26 - 1/27
1/27 - 1/28
1/28 - 1/29
1/29 - 1/30
1/30 - 1/31
1/31 - 1/32
1/32 - 1/33
1/33 - 1/34
1/34 - 1/35
1/35 - 1/36
1/36 - 1/37
1/37 - 1/38
1/38 - 1/39
1/39 - 1/40
1/40 - 1/41
1/41 - 1/42
1/42 - 1/43
1/43 - 1/44
1/44 - 1/45
1/45 - 1/46
1/46 - 1/47
1/47 - 1/48
1/48 - 1/49
1/49 - 1/50
1/50 - 1/51
1/51 - 1/52
1/52 - 1/53
1/53 - 1/54
1/54 - 1/55
1/55 - 1/56
1/56 - 1/57
1/57 - 1/58
1/58 - 1/59
1/59 - 1/60
1/60 - 1/61
1/61 - 1/62
1/62 - 1/63
1/63 - 1/64
1/64 - 1/65
1/65 - 1/66
1/66 - 1/67
1/67 - 1/68
1/68 - 1/69
1/69 - 1/70
1/70 - 1/71
1/71 - 1/72
1/72 - 1/73
1/73 - 1/74
1/74 - 1/75
1/75 - 1/76
1/76 - 1/77
1/77 - 1/78
1/78 - 1/79
1/79 - 1/80
1/80 - 1/81
1/81 - 1/82
1/82 - 1/83
1/83 - 1/84
1/84 - 1/85
1/85 - 1/86
1/86 - 1/87
1/87 - 1/88
1/88 - 1/89
1/89 - 1/90
1/90 - 1/91
1/91 - 1/92
1/92 - 1/93
1/93 - 1/94
1/94 - 1/95
1/95 - 1/96
1/96 - 1/97
1/97 - 1/98
1/98 - 1/99
1/99 - 1/00
1/00 - 1/01
1/01 - 1/02
1/02 - 1/03
1/03 - 1/04
1/04 - 1/05
1/05 - 1/06
1/06 - 1/07
1/07 - 1/08
1/08 - 1/09
1/09 - 1/10
1/10 - 1/11
1/11 - 1/12
1/12 - 1/13
1/13 - 1/14
1/14 - 1/15
1/15 - 1/16
1/16 - 1/17
1/17 - 1/18
1/18 - 1/19
1/19 - 1/20
1/20 - 1/21
1/21 - 1/22
1/22 - 1/23
1/23 - 1/24
1/24 - 1/25
1/25 - 1/26
1/26 - 1/27
1/27 - 1/28
1/28 - 1/29
1/29 - 1/30
1/30 - 1/31
1/31 - 1/32
1/32 - 1/33
1/33 - 1/34
1/34 - 1/35
1/35 - 1/36
1/36 - 1/37
1/37 - 1/38
1/38 - 1/39
1/39 - 1/40
1/40 - 1/41
1/41 - 1/42
1/42 - 1/43
1/43 - 1/44
1/44 - 1/45
1/45 - 1/46
1/46 - 1/47
1/47 - 1/48
1/48 - 1/49
1/49 - 1/50
1/50 - 1/51
1/51 - 1/52
1/52 - 1/53
1/53 - 1/54
1/54 - 1/55
1/55 - 1/56
1/56 - 1/57
1/57 - 1/58
1/58 - 1/59
1/59 - 1/60
1/60 - 1/61
1/61 - 1/62
1/62 - 1/63
1/63 - 1/64
1/64 - 1/65
1/65 - 1/66
1/66 - 1/67
1/67 - 1/68
1/68 - 1/69
1/69 - 1/70
1/70 - 1/71
1/71 - 1/72
1/72 - 1/73
1/73 - 1/74
1/74 - 1/75
1/75 - 1/76
1/76 - 1/77
1/77 - 1/78
1/78 - 1/79
1/79 - 1/80
1/80 - 1/81
1/81 - 1/82
1/82 - 1/83
1/83 - 1/84
1/84 - 1/85
1/85 - 1/86
1/86 - 1/87
1/87 - 1/88
1/88 - 1/89
1/89 - 1/90
1/90 - 1/91
1/91 - 1/92
1/92 - 1/93
1/93 - 1/94
1/94 - 1/95
1/95 - 1/96
1/96 - 1/97
1/97 - 1/98
1/98 - 1/99
1/99 - 1/00
1/00 - 1/01
1/01 - 1/02
1/02 - 1/03
1/03 - 1/04
1/04 - 1/05
1/05 - 1/06
1/06 - 1/07
1/07 - 1/08
1/08 - 1/09
1/09 - 1/10
1/10 - 1/11
1/11 - 1/12
1/12 - 1/13
1/13 - 1/14
1/14 - 1/15
1/15 - 1/16
1/16 - 1/17
1/17 - 1/18
1/18 - 1/19
1/19 - 1/20
1/20 - 1/21
1/21 - 1/22
1/22 - 1/23
1/23 - 1/24
1/24 - 1/25
1/25 - 1/26
1/26 - 1/27
1/27 - 1/28
1/28 - 1/29
1/29 - 1/30
1/30 - 1/31
1/31 - 1/32
1/32 - 1/33
1/33 - 1/34
1/34 - 1/35
1/35 - 1/36
1/36 - 1/37
1/37 - 1/38
1/38 - 1/39
1/39 - 1/40
1/40 - 1/41
1/41 - 1/42
1/42 - 1/43
1/43 - 1/44
1/44 - 1/45
1/45 - 1/46
1/46 - 1/47
1/47 - 1/48
1/48 - 1/49
1/49 - 1/50
1/50 - 1/51
1/51 - 1/52
1/52 - 1/53
1/53 - 1/54
1/54 - 1/55
1/55 - 1/56
1/56 - 1/57
1/57 - 1/58
1/58 - 1/59
1/59 - 1/60
1/60 - 1/61
1/61 - 1/62
1/62 - 1/63
1/63 - 1/64
1/64 - 1/65
1/65 - 1/66
1/66 - 1/67
1/67 - 1/68
1/68 - 1/69
1/69 - 1/70
1/70 - 1/71
1/71 - 1/72
1/72 - 1/73
1/73 - 1/74
1/74 - 1/75
1/75 - 1/76
1/76 - 1/77
1/77 - 1/78
1/78 - 1/79
1/79 - 1/80
1/80 - 1/81
1/81 - 1/82
1/82 - 1/83
1/83 - 1/84
1/84 - 1/85
1/85 - 1/86
1/86 - 1/87
1/87 - 1/88
1/88 - 1/89
1/89 - 1/90
1/90 - 1/91
1/91 - 1/92
1/92 - 1/93
1/93 - 1/94
1/94 - 1/95
1/95 - 1/96
1/96 - 1/97
1/97 - 1/98
1/98 - 1/99
1/99 - 1/00
1/00 - 1/01
1/01 - 1/02
1/02 - 1/03
1/03 - 1/04
1/04 - 1/05
1/05 - 1/06
1/06 - 1/07
1/0

To: Station

From: JMB

Subj.: PER EXPENSES FOR PERIOD 1 April, 1968 - [] 1969.

Since December, 1968, when writer moved into his own home, he was not aware that receipts for utilities etc. would be necessary. As a consequence, the attached are not complete, but they are all that writer has been able to find.

1. Electricity: Receipts are complete.
2. Gas: Receipts are complete from Jan., 1969 to date. The 1968 receipts were destroyed, but the average consumption was the same.
3. Water: In writer's "colonia" there are no water meters. The cost of water, garbage collection, street lighting and cleaning etc. is included in a monthly quota which is paid to the Association of Colonias. The quota was raised in [] 1969 from 75.00 to 200.00 pesos per month.
4. Fuel Oil: Writer found only one receipt during the period in question. Two more are attached to indicate the monthly expense.
5. Firewood: Writer has contracted with an Indian with two burros to deliver wood twice each month. Each delivery is 56.00. The Indian is illiterate and receipts are not feasible.

STATE OF TEXAS
 COUNTY OF _____

(BY _____)

MONTH	AMOUNT	DATE	AMOUNT	DATE	AMOUNT
April 1968			75.00	75.00	112.-
May "			75.00	75.00	112.-
June "	1088.80		75.00	75.00	112.-
July "			75.00	75.00	112.-
August "	935.00		75.00	75.00	112.-
Sept "			75.00	75.00	112.-
Oct "	1847.00		75.00	75.00	112.-
Nov "			75.00	75.00	112.-
Dec "	1036.75		75.00	75.00	112.-
Jan 1969		119.20	75.00	75.00	112.-
Feb "	1362.85	121.95	75.00	75.00	112.-
Mar "		133.50	75.00	75.00	112.-
Apr "	1040.00	33.25	75.00	75.00	112.-
May "		184.00	75.00	75.00	112.-
June "	1000.40	20.75	75.00	75.00	112.-
July "		147.50	75.00	75.00	112.-
Aug "	1005.35	100.95	75.00	75.00	112.-
Sept		40.00	200.00	200.00	112.-
Oct		999.35	75.00	75.00	112.-

I CERTIFY THAT THE AMOUNTS CLAIMED ABOVE HAVE BEEN PAID BY ME AS NECESSARY AUTHORIZED EXPENSES OF MAINTAINING MY LEVING QUARTERS: THAT I HAVE NOT BEEN, NOR WILL I BE, REMBURSED FROM OTHER SOURCES EXCEPT AS INDICATED HEREIN AND THAT THIS ACCOUNT AND ACCOUNTS, IF ANY, ARE TRUE AND CORRECT IN ALL PARTICULARS.
 MY ORDER WITH NUMBER IS 416. I REQUEST _____ HOLDING THIS AND NUMBER OF TRANSMITTED REPLY WITH ME _____ NUMBER OF TRANSMITTED REPLY FROM POLICE _____

(X)

EXHIBIT NOTICE

ATTACH ALL RECEIPTS - WILL BE
 RETURNED TO YOU AFTER _____

of being as useful as a person's own money on the

... of personally owned quarters as SF-1140 should
... all the initial purchase price of such quarters
... (7) shall show normal rates for utilities as
... of the Standardized Population (Government
...). These are the only items of cost to be

... system provided for quarters as follows:
... the purchase price of such quarters should not exceed the
... at the exchange rate of the dollar and the
... utility. The cost of such quarters
... depreciation, interest, and other
... a person's own quarters. Only light, fuel, and water should be taken at
... allowance.

... it is suggested that the SF-1140
... authorizing officer should be necessary to
... of the Standardized Population.
... quarters would be treated the same as
... (except that no cannot receive advance payment of quarters
... under Section 113 of the Standardized Population). This would
... a special rate for personally owned quarters. The requirement
... to report the purchase price on SF-1140 is to provide the authorizing
... officer additional information to be considered, together with any other
... local circumstances, in deciding whether reduction of the
... allowance is necessary and, if so, how much. Only the utility costs are
... to be considered in addition to the purchase price, except in those rare
... instances where this may be justified. Because of varying conditions
... between persons and individuals, it was not considered advisable to use by
... any certain percentage of the purchase price that may be determined.

In addition to the information on the SF-1140, the authorizing officer
... should consider the circumstances, when they are readily available, in
... whether the receipt of quarters should be treated differently and the employee is treated quarters and report of
... the flat rate allowance.

J.A. [unclear]
1/1/61

PERSONALLY-OWNED QUARTERS

Because of the number of inquiries received regarding personally-owned quarters, the following memorandum which has been sent to a number of posts may be useful as a guide to our policy on the subject:

When an employee occupies personally owned quarters his SF-1190 should show in Section 21 (5) the initial purchase price as shown by the deed. Section 21 (6) (7) and (8) should show annual rates for utilities as authorized by Section 132.5 of the Standardized Regulations (Government Civilians, Foreign Areas). These are the only items of cost to be considered.

When the quarters allowance system provided for reimbursement for quarters costs within a predetermined maximum, the regulations provided that the allowance for personally owned quarters should not exceed 10 percent of the purchase price, converted to dollars at the exchange rate available at the time of purchase, plus allowable utilities. The 10 percent of purchase price was ample to take care of taxes, depreciation, repairs, interest on investment, and amortization of the costs within a reasonable period of time by U. S. standards. Only light, fuel, and water could be added in arriving at the allowance.

Under the current quarters allowance system, it is expected that the flat rate will be paid unless the authorizing officer believes it necessary to reduce the payment under Section 134.2 of the Standardized Regulations. The employee in personally owned quarters would be treated the same as any other (except that he cannot receive advance payment of quarters allowances under Section 113 of the Standardized Regulations). This makes unnecessary a special rate for personally owned quarters. The requirement to report the purchase price on SF-1190 is to provide the authorizing officer additional information to be considered, together with any other pertinent local circumstances, in deciding whether reduction of the allowance is necessary and, if so, how much. Only the utilities costs are to be considered in addition to the purchase price except in those rare instances where land rent is involved. Because of varying conditions between posts and individuals, it was not considered advisable to specify any certain percentage of the purchase price that should be considered.

In addition to the information on the SF-1190, the authorizing officer should consider local circumstances, which vary greatly from post to post, in deciding whether the occupant of personally owned quarters should be treated any differently than the employee in rented quarters and receiving the flat rate allowance.

O/ALS:
9/5/67

[Redacted]

MESSAGE FORM
TOTAL COPIES: 14

SECRET

ROUTING AND/OR INITIALS - SEEN BY		
1		0
2		0
3		1
4		0

TO: FINANCE
R: CICS
RE: 23 DECEMBER 1969

SEE SECRETARIAT DISSEMINATION

INDEX NO INDEX RETURN TO _____ BRANCH FILE RID
 FILE IN CS FILE NO. _____

REF: OFZ FILE, VII. WBS DRP ADP

(classification)

(date and time filed)

(office)

(place)

SECRET

CITE DIRECTOR

CHIEF OF STATION, [Redacted]

00 16 14z JAN 70

1. JEREMY K. BENADUM'S FLAT RATE TAX ASSESSMENT INCREASED FROM 000507
21.9% PLUS SURTAX TO 22.9% PLUS SURTAX EFFECTIVE 14 DECEMBER 1969 FOR TAX
YEAR 1970.

2. NET DUE BENADUM EACH PAY PERIOD WILL BE \$1,263.26. SEE STATEMENT OF
EARNINGS AND DEDUCTIONS FOR BREAKDOWN.

END OF MESSAGE

7 JAN 1970

[Redacted]

[Redacted]

[Redacted]

[Redacted]

C/ARR/S

C/AR/BF-L/

C/C&TD

ISSUING OFFICER

COORDINATING OFFICERS

SECRET

GROUP 1
Excluded from automatic
downgrading and
declassification

AUTHENTICATING OFFICER

REPRODUCTION BY OTHER THAN THE ISSUING OFFICE IS PROHIBITED.

COPY NO.

5
4
3
2
1

CABLE SECRETARIAT DISSEMINATION		CLASSIFIED MESSAGE	TOTAL COPIES	ROUTING AND/OR INITIALS-BEEN BY	
PERSON/UNIT NOTIFIED		SECRET (When Filled In)	GROUP 1	1	5
ADVANCE COPY <input type="checkbox"/> ISSUED <input type="checkbox"/> NOTIFIED			EXCLUDED FROM AUTOMATIC DOWNGRADING AND DECLASSIFICATION	2	6
BY: _____ AT: _____			REPRODUCTION OF THIS COPY PROHIBITED	3	7
DESIGN BY: <u>KS</u> PER: _____			INDEX: <input type="checkbox"/> YES <input type="checkbox"/> NO	4	8
ACTION UNIT		CLASSIFY TO CS FILE NO. _____	FILE NO. _____		
ACTION NO.		REF TO CS FILE NO. _____	BRANCH _____		
906		<input type="checkbox"/> FILE RD <input type="checkbox"/> RETURN TO _____	BRANCH _____		
OFZ		FILE, YR <u>W48</u>			

SECRET 112322Z SEP 69 CITE [] 1370

DIRECTOR

11 SEP 69 IN 42617
M

DTEARN

REF HMMS-6543

1. PLEASE ADVISE NAME AND ADDRESS OF ALLOTTEE BANK WHERE JEREMY K. BENADUM CHECK WOULD BE DEPOSITED PER REF.
2. IF CHECK NOT YET SENT, BENADUM REQUESTS THAT WE PAY LOCALLY.
3. PLS ADVISE.
4. FILE: 52-S-91/2.

Case Agent

RJT h

SECRET

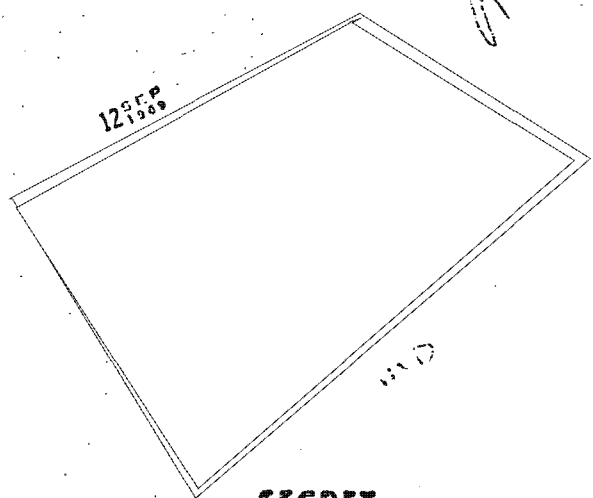

SECRET

4/

MESSAGE FORM TOTAL COPIES. 12
SECRET

ROUTING AND/OR INITIALS - SEE BY	
1	
2	
3	
4	

TO: [Redacted]
FROM: FINANCE
2125
DATE: 12 SEPTEMBER 1969

FILE SECRETARIAT DISSEMINATION
46 PER [Redacted]
 INDEX NO INDEX RETURN TO [Redacted] BRANCH FILE NO.
 FILE IN CS FILE NO. [Redacted]

REF: OF 2 FILE. VR. WH 8

(classification) (date and time filed) (reference number) (pic)

SECRET

CITE DIRECTOR 38732
7

17 22 04z SEP 69

EF: CITE [Redacted] 1370** (IN 42617)

1. TAX ASSESSMENT CHANGE EFFECTIVE 14 JULY 1969 INCREASES NET PAID BY STATION TO JEREMY K. BENADUM. IN PAY PERIOD 24 AUGUST - 20 SEPTEMBER 1969 PAY AND T/A TO HEADQUARTERS THE SUM OF \$1,355.99. NET DUE BENADUM WILL BE \$1,295.24 EACH PAY PERIOD THEREAFTER. SEE STATEMENT OF EARNINGS AND DEDUCTIONS FOR BREAKDOWN.

2. BENADUM ALSO DUE \$729.40 FOR 1968 TAX REFUND. PLEASE PAY IN FIELD AND T/A TO HEADQUARTERS.

END OF MESSAGE

**SUBJECT REQUESTS LOCAL PAYMENT

[Redacted]
C/WH/29

[Redacted]
COORDINATING OFFICERS

[Redacted]
C/CDTD

RELEASING OFFICER

SECRET

CLASSIFIED
Excluded from automatic
downgrading and
declassification

AUTHENTICATING OFFICER

REPRODUCTION BY OTHER THAN THE ISSUING OFFICE IS PROHIBITED.

FORM 8-69

SECRET

DATE:

CTC No. _____

MEMORANDUM FOR: Director of Finance

ATTENTION: Chief, Compensation and Tax Division

VIA: Chief, Contract Personnel Division

SUBJECT: Tax Assessment for _____

1. A flat rate covert tax assessment of this individual's gross, taxable Agency entitlements has been approved by the Covert Tax Committee as indicated below. An acknowledged letter of tax instruction is will be forwarded.

Tax Assessment Rate

Effective Date

2. Other payroll factors pertinent to this Covert Tax Committee tax assessment action are as follows:

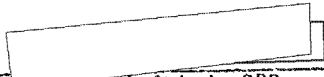
Approval, Chief, CPD

Secretary, Covert Tax Committee

FORM 7049

SECRET

CPD

SECRET

Mr. Jeremy K. Benadon.

Dear Mr. Benadon:

Reference is made to your contract with the United States Government, as represented by the Contracting Officer, effective 30 October 1960.

The purpose of this amendment is to formally record your official designation as a participant in the Retirement and Disability System of this organization, effective 24 August 1965. Your contributions into the Retirement and Disability Fund will be deducted by this organization as of that date. The regulations governing this retirement system, gives the individual the right to appeal such a determination if he deems the designation adverse to his best interest. In order that this technical requirement may be satisfied, you are hereby notified of your right to appeal. An appeal with reasons therefor must be received in this organization within thirty (30) days from the date of your acknowledgment of this contract amendment.

Effective close of business 23 August 1965 all contractual reference to Civil Service Retirement and your contributions thereto is deleted.

Social Security contributions required by virtue of will not be reimbursed you by this organization.

All other terms and conditions of this contract remain in full force and effect.

APPROVED:

Jeremy K. Benadon.

1
Contracting Officer

SECRET

MEMORANDUM FOR: Chief, Contract Personnel Division

SUBJECT : Designation of Jeremy K. BENADUM as a
Participant in the CIA Retirement and
Disability System

1. It is requested that the contract of Jeremy K. BENADUM be amended to officially record his designation as a participant in the CIA Retirement and Disability System effective 23 August 1969.
2. This contract amendment will serve as BENADUM's official notification of his designation as a participant.

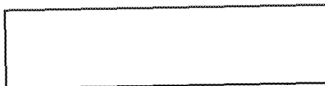

Robert S. Wattles
Director of Personnel

SECRET

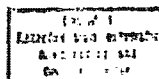

MESSAGE PAGES
VIA AIRMAIL

SECRET

NO.	DATE	BY	REMARKS
1			
2			
3			
4			
5			
6			

DATE: 7 JULY 1969

ABLE SECRETARIAT DISSEMINATION

INDEX DESTROY RETURN TO _____ BRANCH FILE BID

BY 2/f PER _____

NO INDEX FILE ON CS FILE NO.

ONP: OF-2

BID COPY

INFO: FILE VB WH-2

(Classification) (date and time filed) (office) (reference number) (page)

SECRET

CITE DIRECTOR

00 10 53z JUL 69

49031 7

MEXICO CITY

PAY RAISE EFFECTIVE 13 JULY 1969 INCREASED NET PAID BY STATION TO JEREMY K. BENADUM. IN PAY PERIOD 29 JUNE - 26 JULY 1969 PAY AND T/A TO HEADQUARTERS THE SUM OF \$1,199.98. NET DUE BENADUM WILL BE \$1,254.74 EACH PAY PERIOD THEREAFTER. SEE STATEMENT OF EARNINGS AND DEDUCTIONS FOR BREAKDOWN.

END OF MESSAGE

10/506

WH/1
WH/CONT

[Redacted]

[Redacted] [Redacted]

[Redacted]

C/WH/EB

[Redacted]

C/C/ED

ISSUING OFFICE

COORDINATING OFFICE
SECRET

SECURITY

AUTHORITY

REPRODUCTION BY OTHER THAN THE ISSUING OFFICE IS PROHIBITED.

SECRET

10 JUN 1969

MEMORANDUM FOR: Chief, Audit Staff

VIA : SSA/DDS

SUBJECT : Jeremy K. BENADUM, [REDACTED]

REFERENCES : A. Audit Staff Memo, 17 March 1968,
Subject: Clarification of [REDACTED]

B. WHD Memo, 12 May 1968, Same Subject

1. Reference A indicated that since October 1961, Career Agent Jeremy K. BENADUM had not submitted [REDACTED]

Reference B indicated that [REDACTED] had been requested to forward information in relation to Reference A.

2. Attached is a copy of the certification by Jeremy K. BENADUM [REDACTED]

[REDACTED]

[REDACTED]

[REDACTED]

William V. Broe
Chief
Western Hemisphere Division

DDP/WH/Contracts:WSEnchan:ad (9 June 1969)

Distribution: Orig & 1 - Addressee
1 - SSA/DDS
1 - WH/B&F
1 - WH/1
2 - WH/Contracts
1 - OF/C&TD/SAAS

SECRET

FORMATION AND DETERMINATION OF PARTICIPANT
CIA REDEFINITION OF QUALIFYING SERVICE

STATE OF: ILLINOIS

1. FULL NAME: (S) (M) (L) (S) 2. NAME OF AGENCY OR OFFICE: Special Agent 3. TYPE OF SERVICE: REGULAR 4. SSN: [REDACTED] 5. EMPLOYER'S OFFICE OR HOME ADDRESS: [REDACTED]

6. NUMBER OF OCCUPATIONAL TITLES: 1 7. NUMBER OF PERIODS OF ASSIGNMENT: 1

8. OCCUPATIONAL TITLE: Special Agent 9. DATE OF ASSIGNMENT: 10/15/53

10. CURRENTLY COMPLETING: YES NO 11. SERVICE COMPUTATION: 10/15/53 to 10/15/55

PERFORMANCE OF QUALIFYING SERVICE

1. Has this employee completed any qualifying service? YES NO. If "Yes", list periods of such service below:

BEGINNING DATE (Month/Year)	OCCUPATIONAL TITLE	LOCATION WHERE SERVICE PERFORMED (City, County, or State)	PERIOD OF SERVICE				TOTAL TIME
			PCS	TDS	MONTHS	DAYS	
08/30/60	Special Agent	Springfield	X				

2. Is this employee currently performing qualifying service? YES NO. If "Yes", complete the following:

BEGIN DATE	END DATE	OCCUPATIONAL TITLE	LOCATION	PCS	TDS	MONTHS	DAYS

3. If employee was assigned in the United States during any period of qualifying service listed or pointing out those conditions which are not the requirements of QUALIFYING SERVICE, describe his duties below:

[REDACTED]

JUN 1963

4. Is this employee currently on official orders for a PCS assignment requiring the performance of qualifying service? YES NO. If "Yes", attach a certification to this effect.

5. CERTIFICATION - This information furnished above has been verified against official Agency records. Where no official record was available, a supporting statement is attached.

6. SPECIAL NAME AND TITLE OF CAPTION SERVICE: _____ 7. SIGNATURE: _____ 8. DATE: _____

Continued on Reverse Side

SECTION 1

STATES (2) (MAY 1964 EDITION)

SECTION C

(TO BE COMPLETED BY CAREER SERVICE REPRESENTATIVE)

- Form 201, Service Agreement, is attached.
- Because of temporary absence of the employee, Form 201, Service Agreement, will be forwarded at a later date.
- (1) Employee has over 15 years of Agency service or (2) employee cannot be readily contacted to sign a Service Agreement. The signed "Application for Membership in the Career Staff of the CIA" on file in the employee's Official Personnel Folder should be accepted as proof of Form 201, Service Agreement.
- Nonmember employee and a signed "Application for Membership in the Career Staff of the CIA" is NOT filed in his Official Personnel Folder. Form 201, Service Agreement, will be requested from the field upon notification that the CIA Retirement Board has recommended approval of his nomination.

SECTION D BY COMPLETION OF HEAD OF CAREER SERVICE

1. Based on his career assignment and past and prospective performance of qualifying service, this employee is recommended for designation as a participant in the CIA RETIREMENT AND DISABILITY SYSTEM. He is serving in a career field which normally requires the performance of qualifying service as an integral part of a career in that field.

2. TYPED NAME AND TITLE	3. SIGNATURE OF HEAD OF CAREER SERVICE	4. DATE
-------------------------	--	---------

SECTION E RECOMMENDATION OF CIA RETIREMENT BOARD

1. The record of this employee has been reviewed and the CIA RETIREMENT BOARD has recommended on _____ (DATE) that this employee

- be designated as a participant in the CIA RETIREMENT AND DISABILITY SYSTEM
- NOT be designated as a participant

2. TYPED NAME AND TITLE	3. SIGNATURE	4. DATE
-------------------------	--------------	---------

SECTION F DETERMINATION BY DIRECTOR OF PERSONNEL

1. In accordance with Regulation 20-50, this employee is DESIGNATED NOT designated a participant in the CIA Retirement and Disability System.

2. SIGNATURE OF DIRECTOR OF PERSONNEL	3. DATE
---------------------------------------	---------

SECTION G ADDITIONAL INFORMATION

I certify that the information in Section _____ is true to the best of my knowledge.

DISPATCH ~~SECRET~~ ~~SECRET~~

PROCESSING ACTION

TO
Chief, WH Division

XX

MAILED FOR INDEXING

NO INDEXING REQUIRED

INFO.

ONLY QUALIFIED DESK

CAN JUDGE INDEXING

FROM
Chief of Station, Mexico City

NUMBER

SUBJECT
LITEMPO/Jeremy K. BENADUM - Agent Evaluation

ACTION REQUIRED - REFERENCES

ACTION REQUIRED: For Your Information

REFERENCES : A. HMMA-32877, 28 August 1967
B. DIRECTOR-99663

1. In accordance with the request made in Reference B, the following is an up-dated Agent Evaluation on Jeremy K. BENADUM, Career Agent and outside Case Officer for the LITEMPO Project. This evaluation should be considered in conjunction with Reference A, which is still valid and more extensive.

2. BENADUM continues to perform as the Outside Case Officer for the LITEMPO Project in a professional and efficient manner.

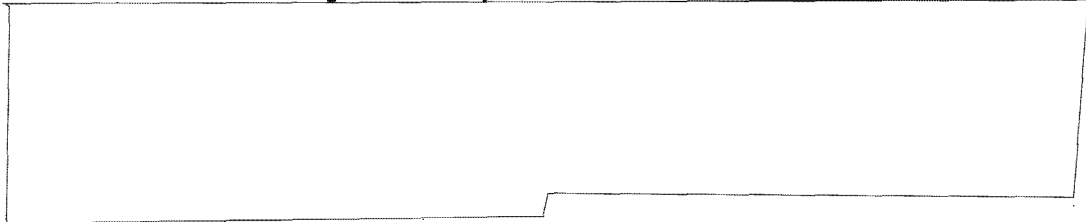

Continued.....

Distribution:
Orig and 2 - Chief, WHD

CLASSIFICATION TO

DISPATCH SYMBOL AND NUMBER

HMMA-37220

DATE

10 June 1969

~~SECRET~~ ~~SECRET~~

DISPATCH SYMBOL

301-287227

[Redacted]

4. BENADUM writes well and has improved considerably in providing information he obtains from his contacts in written form. Usually, the reports he submits need little editing in order to be processed for dissemination.

[Redacted]

[Redacted]

Based upon the Regular Fitness Report system, this Officer could be rated as STRONG in judging his performance.

[Redacted]

8. BENADUM was shown this evaluation in draft form.

Willard C. CURTIS

TO: [redacted]
FROM: WH/Contracts
INFO: 4460
DATE: 4 June 1969

MESSAGE FORM
TOTAL COPIES:

SECRET

ROUTING AND/OR INITIALS - SEE NO.	
1	5
2	6
3	7
4	8

ABLE SECRETARIAT DISSEMINATION INDEX NO INDEX RETURN TO _____ BRANCH FILE RID
PER _____ # _____ FILE IN CS FILE NO. _____

INFO: WH/8
FILE NO. OP2 CILA CSPS

(classification) SECRET/RYBAT

(date and time filed) 05 20 45z JUN 69

(reference number) 08720

CITE DIRECTOR

MEXICO CITY

ADMIN CONTRACTS

REF: MEXICO CITY 0421 (IN 68828)

1. APPROVE JEREMY K. BENADUM CONTINUING IN STATUS *CAREER AGENT PM*
UNTIL 31 OCTOBER 1970.
2. PROCESSING REQUEST FOR BENADUM ACCEPTANCE INTO WOFIRM
RETIREMENT PROGRAM WITH RETIREMENT DATE EFFECTIVE 31 OCT 70.
WILL ADVISE.
3. FILE: 201-287227

END OF MESSAGE

WH COMMENT: Concerning Jeremy K. BENADUM. HMCT-9712 had as

[redacted]

COORD: C/WH/1

Mr. [redacted]

WILLIAM V. BROOK
C/WH/D

WILLIAM S. RENEHAN
C/WH/CONTRACTS

COORDINATING OFFICERS

SECRET

GROUP 1
Excluded from automatic
downgrading and
declassification

AUTHENTICATED
OFFICER

REPRODUCTION BY OTHER THAN THE ISSUING OFFICE IS PROHIBITED.

COPY NO.

CABLE SECRETARIAT DISSEMINATION		CLASSIFIED MESSAGE	TOTAL COPIES	ROUTING GROUP INITIALS - SEEN BY	
PERSON/UNIT NOTIFIED		SECRET <small>(When Filled In)</small> GROUP 1 <small>EXCLUDED FROM AUTOMATIC DECLASSIFICATION AND DOWNGRADING</small>	1 2 3 4 5	6	
ADVANCE COPY <input checked="" type="checkbox"/> ISSUED <input type="checkbox"/> SLOTTED				7	
BY: <i>dk</i> AT: <i>1735</i>				8	
DISSEM BY: <i>dk</i> PER: <i>9</i>				9	
ACTION: <i>clm 8</i> <input type="checkbox"/> RID COPY				10	
REPRODUCTION OF THIS COPY PROHIBITED INDEX: <input type="checkbox"/> YES <input type="checkbox"/> NO CLASSIFY TO FILE NO. _____ X-REF TO FILE NO. _____ FILE RID <input type="checkbox"/> REF. TO _____ BRANCH <input type="checkbox"/> DESTROY <input type="checkbox"/> S/G		PRECEDENCE			
INFO FILE VS. <i>clcs 2, clcs 3, DAP</i>					

SECRET 041610Z JUNE 69 CITE MEXICO CITY 0486 4 JUN 69 IN 73313

PRIORITY DIRECTOR

RYBAT ADMIN PERS

REF: MEXICO CITY 0421 (W 68828)

REQUEST ANSWER REFERENCE BY COB 6 JUNE AS BENADUM NEEDS TO BE ABLE TO MAKE JOB COMMITMENTS TO PROSPECTIVE EMPLOYER.

SECRET

5 JUN 69
gm
Answered
6/5/69
gm
Ref

SECRET

CABLE SECRETARIAT DISSEMINATION		CLASSIFIED MESSAGE	TOTAL COPIES (14)	READING AND/OR INITIALS - SEEN BY	
PERSON/UNIT NOTIFIED		SECRET (When Filled In) REPRODUCTION OF THIS COPY FROM SITES INDEX <input type="checkbox"/> YES <input type="checkbox"/> NO CLASSIFY TO FILE NO. _____ X-REF TO FILE NO. _____ FILE RID <input type="checkbox"/> RET. TO _____ BRANCH <input type="checkbox"/> DESTROY <input type="checkbox"/> SIG. _____		0	
ADVANCE COPY <input type="checkbox"/>	ISSUED <input type="checkbox"/>			2	7
	SLOTTED <input type="checkbox"/>			3	8
BY: _____	AT: _____			4	9
DISSEM BY: <u>DKB</u>	PER _____			5	10
ACTION	<input type="checkbox"/> RID COPY	INFO:	FILE NO. <u>elccor elcsp. p/02</u>		

SECRET 290032Z MAY 69 CITE MEXICO CITY 0421

23 MAY 69 IN 68828

DIRECTOR

RYBAT ADMIN-PERS

REFS: A. CONVERSATIONS COS MEXICO CITY HAD WITH HQS REPS 26-27 MAY

B. HMMT 9712

C. HMMT 9753

1. CONCERNING JEREMY K BENADUM REFERENCE B HAD AS ATTACHMENTS

[REDACTED]

2. REFERENCE C DATED 28 MAY 1969 HAS FOLLOWING ATTACHMENTS:

A. "SERVICE AGREEMENT" FORM SIGNED BY BENADUM

AND B. MEMORANDUM FROM BENADUM REQUESTING EFFECTIVE DATE OF HIS RETIREMENT BE 31 OCTOBER 1970 (IN ORDER TO GIVE NEW COS TIME TO BUILD RELATIONSHIPS WITH LITEMPOS AND TO GIVE BENADUM TEN YEARS OF SERVICE IN WOFIRM AND MAKE HIM

ELIGIBLE FOR WOFIRM RETIREMENT).

3. REQUEST CABLED REPLY SINCE IF BENADUM TO BE RETIRED EFFECTIVE 30 JUNE 1969 HE MUST FIRM UP OTHER EMPLOYMENT.

SECRET

[REDACTED]

SECRET

DISPATCH		CLASSIFICATION SECRET/RYBAT		PROCESSING ACTION	
TO Chief, WH Division		XX	MARKED FOR INDEXING	INFO.	NO INDEXING REQUIRED
FROM Chief of Station, Mexico City			ONLY QUALIFIED DESK (CAN JUDGE INDEXING)	SUBJECT Jeremy K. BENADUM - Retirement	MEMORANDUM
ACTION REQUIRED - REFERENCES					
Reference: HMMT-9712 dated 16 May 1969					
1. Reference is made to conversations COS, Mexico City, had at Headquarters on 26 May and 27 May 1969 concerning the postponement of the effective date of retirement of Jeremy K. BENADUM until 31 October 1970 in order:					
<ul style="list-style-type: none"> a). To enable BENADUM to acquire eligibility for WOFIRM retirement; and, b). To give the new COS, Mexico City, time to build up relationships with the LITEMPOS (the LITEMPO Project) with whom BENADUM now has excellent, close and long-standing relationships. 					
2. Headquarters suggested that:					
<ul style="list-style-type: none"> a). BENADUM sign the regular "Service Agreement" form by which he requests that he become a member of the WOFIRM "Organization Retirement and Disability System"; and, that b). BENADUM write a memorandum requesting that his date of retirement be postponed from 30 June 1969 until 31 October 1970. 					
3. These two forms are attached, in the original and one copy each.					
4. It is requested that, after receipt and study of the attachments and the attachments sent with reference, Headquarters cable Mexico City and advise whether or not BENADUM is now to be assured that his retirement date is 31 October 1970.					
Attachments: Herewith Distribution: 3 - C/WID w/atts.				Willard C. Curtis	
CROSS REFERENCE TO	DISPATCH SYMBOL AND NUMBER IDMT-9753	DATE 28 May 1969			
CLASSIFICATION SECRET/RYBAT		NOT PRE NUMBER			

CLASSIFIED MESSAGE		TOTAL COPIES	ROUTING AND/OR INITIALS - SEE PDY	
SECRET (When Filled In)		GROUP 1	1	6
REPRODUCTION OF THIS COPY PROHIBITED		GROUP 2	2	7
INDEX <input type="checkbox"/> YES <input type="checkbox"/> NO		GROUP 3	3	8
CLASSIFY TO FILE NO. _____		GROUP 4	4	9
R-REF TO FILE NO. _____		GROUP 5	5	10
FILE RID <input type="checkbox"/> RET. TO _____		BRANCH <input type="checkbox"/> DESTROY <input type="checkbox"/> SIG		
DISSEM BY <u>JA</u> PER _____		INFO		
ACTION		FILE VR. <u>cf/WH 8</u>		
<input type="checkbox"/> RID COPY		<u># 895</u>		
		<u>CF/R/SO G/C, G/FR-2, G/OT</u>		

SECRET 130120Z MAY 69 CITE MEXICO CITY 0200

DIRECTOR

RYBAT ADMIN LITEMPO

608
13 MAY 69 145660R

REFS: A. DIRECTOR 99663

B. MEXICO CITY 0023 (17 53312)

1. AT TIME PROJECT LITEMPO SUBMITTED FOR RENEWAL IT NOT KNOWN THAT CURTIS RETIRING AS OF 30 JUNE 69. IT STATION'S OPINION THAT IF CURTIS AND BENADUM LEAVE SIMULTANEOUSLY (1 JULY 69) PROBERT WILL LACK TIME TO BUILD-UP RELATIONSHIP WHICH BENADUM HAD HAD FOR [REDACTED] AND CURTIS FOR [REDACTED] YEARS WITH THIS

[REDACTED]

2. TELL CURTIS DEPARTURE CHANGES PICTURE SUFFICIENTLY TO WARRANT AMENDMENT TO LITEMPO PROJECT TO ALLOW FOR RETENTION BENADUM.

SECRET

CABLE SECRETARIAT DISSEMINATION PERSONNEL NOTIFIED	CLASSIFIED MESSAGE	TOTAL COPIES	ROUTING AND/OR INITIALS - SEEN BY			
ADVANCE COPY <input type="checkbox"/> ISSUED <input type="checkbox"/> SLOTTED <input type="checkbox"/> BY _____ AT _____ DESIGNED BY _____ PER _____ ACTION <input type="checkbox"/> RID COPY	SECRET <small>(When Filled In)</small> REPRODUCTION OF THIS COPY PROHIBITED INDEX: <input type="checkbox"/> YES <input type="checkbox"/> NO CLASSIFY TO FILE NO. _____ X-REP TO FILE NO. _____ FILE RID <input type="checkbox"/> RET. TO _____ BRANCH <input type="checkbox"/> DESTROY <input type="checkbox"/> S/G	<small>GROUP 1 EXCLUDED FROM AUTOMATIC DOWNGRADING AND DECLASSIFICATION</small>	1	6		
			2	7		
			3	8		
			4	9		
			5	10		
	INFO: FILE, VR.					

PAGE 2 MEXICO CITY 0200 S E C R E T

3. ON OTHER HAND, STATION CONCERNED WITH TOTAL COSTS OF PROJECT. REQUEST HEADQUARTERS ADVISE STATION IF IT POSSIBLE TO AMEND BENADUM CONTRACT WHICH WOULD KEEP HIM AS CAREER AGENT, BUT AT SALARY IN HAND (AFTER RETIREMENT, FEGLI, TAX ETC.) OF ABOUT \$15,000.00 PER ANNUM. POV ALLOWANCE OF 3600 PER ANNUM AND NO ADDITIONAL BENEFITS, BUT WITH RIGHT ACCEPT OTHER PART-TIME EMPLOYMENT.

4. IF ABOVE POSSIBLE, WILL DISCUSS WITH BENADUM.

5. PLS ADVISE BY CABLE.

S E C R E T

SECRET

SECRET

100

MEMORANDUM FOR: Chief, Audit Staff

SUBJECT : Jeremy K. BENADUM, [REDACTED]

REFERENCE : Audit Staff Memo, Dated 17 March 1969.
Subject: Clarification of [REDACTED]
Status of Career Agent, Jeremy K. BENADUM

[REDACTED]

2. The Mexico City Station has been requested to:

[REDACTED]

b. If reports for previous years not readily available, BENADUM is to prepare and provide the Station for transmittal within a reasonable period.

[REDACTED]

3. Upon receipt from Mexico of the requested information, the Division will take appropriate action.

William V. Broe
Chief
Western Hemisphere Division

Distribution:
Orig. & 1 - C/Audit Staff
1 - SSA/LDS
1 - OP/CPD
1 - O/Fin
1 - O/IG

SEARCHED
SERIALIZED
INDEXED
FILED

S E C R E T

28 May 1969

MEMORANDUM

SUBJECT : Jeremy K. BENADUM - Request for Retirement

1. I herewith request that the effective date of my retirement be set as of 31 October 1970 instead of 30 June 1969.
2. This request is based primarily upon my desire to complete ten years of service in the Agency as is required by law in order to be eligible for Agency Retirement instead of being retired under Civil Services Statutes.
3. Secondly, however, I believe that by remaining in my present position until 31 October 1970 I can assure
4. I should appreciate a reply as soon as possible, since if my proposal is not accepted, I shall plan to accept other employment on 1 July 1969.

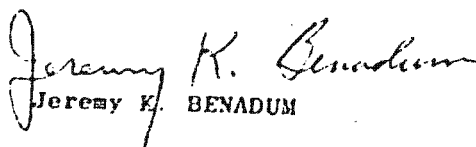
Jeremy K. BENADUM

S E C R E T

S E C R E T

SERVICE AGREEMENT

I understand that in order to qualify for designation as a participant in the Organization Retirement and Disability System, an employee must have signed a written obligation to serve anywhere and at any time according to the needs of the Organization in addition to meeting other specified criteria.

I hereby declare my intent to comply with this requirement as a condition to my being considered for designation as a participant in the Organization Retirement and Disability System.

In making this declaration, it is understood that the Organization will consider my particular capabilities, interests, and personal circumstances.

Jeremy K. Bushum
Signature

28 May, 1969
Date

S E C R E T

DISPATCH		CLASSIFICATION SECRET RYBAT	PROCESSING ACTION
TO	Chief, WH Division		MARKED FOR INDEXING
INFO.		XX	NO INDEXING REQUIRED
FROM	Chief of Station, Mexico City		ONLY QUALIFIED DESK CAN JUDGE INDEXING
SUBJECT	ADMIN/PERS/Jeremy K. BENADUM - Forwarding of Documents		
ACTION REQUIRED: REFERENCES			
ACTION REQUIRED: For Your Information			
REFERENCES : A. DIRECTOR-99663 B. HMNT-9686			
<p>1. In compliance with Reference A, forwarded herewith are the following:</p> <ul style="list-style-type: none"> a. Para 4c - Copy of Station memorandum to BENADUM. b. Para 6a - BENADUM's certification regarding <p>BENADUM's statement requested by paragraph 4c of Reference A was forwarded to Headquarters by Reference B.</p> <p>2. As requested by paragraph 5b of Reference A, BENADUM's completed Form SF-144 is forwarded Under Separate Cover.</p> <p style="text-align: right;"><i>Willard C. Curtis</i> for Willard C. CURTIS</p>			
<p>Attachments:</p> <ul style="list-style-type: none"> 1 - Station memo, h/w 2 - BENADUM Certification, h/w 3 - SF-144, U.S.C. <p>Distribution: Orig and 1/- Chief, WHD, w/atts 1, 2, 3</p>			
<p>HMNT-9719</p> <p>SECRET RYBAT</p>		<p>16 May 1969</p>	

H/W ATTACHMENT #1 TO: HRCR-9712, 1 MAY 1969

7 April 1969

SUBJECT: Retirement

1. Reference is made to our conversations concerning the possibility of your retirement from our service.
2. I discussed this matter, along with all other personnel matters, while in Washington in March 1969; and the authorities indicated that they would like your retirement to become effective on 30 June 1969.
3. For your information, a drive is on to have officers over fifty years of age take advantage of the early retirement program, in order to:
 - a. Allow younger officers to move into active operational assignments;
 - b. Reduce expenses, by getting rid of the higher ranking (older) officers;
 - and
 - c. Put the early retirement program into effective use and make it customary for fifty year old officers to retire.
4. In order to carry out your retirement, I would appreciate it if you would submit your letter confirming that you are in accord with this plan to place you on retired status.

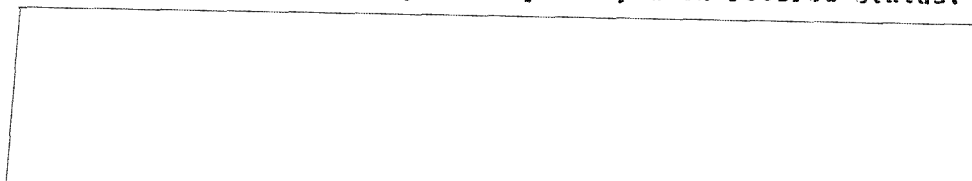

6. I regret that you will be unable to take home leave at Government expense; but regulations prohibit the payment of home leave expenses for persons within two years of effective retirement date.

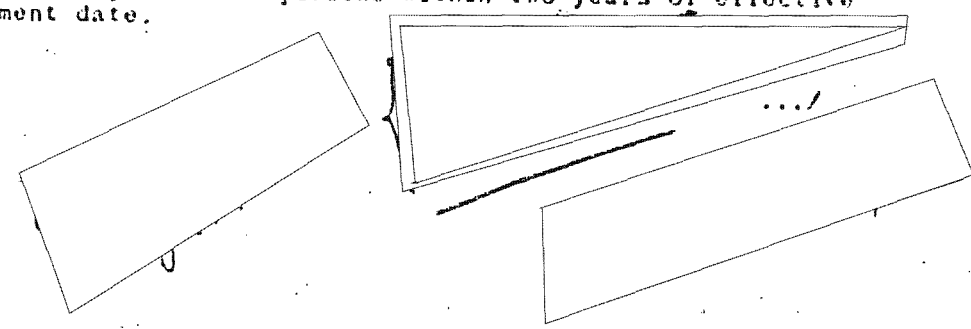

7. The amount of your annual annuity, the pay allowable for your accumulated annual leave and other data relative to your retirement will be discussed in memoranda to follow.

8. I am in the same "boat" with you on several of the above items, if that is of any comfort.

9. Please sign this memorandum and return it to me.

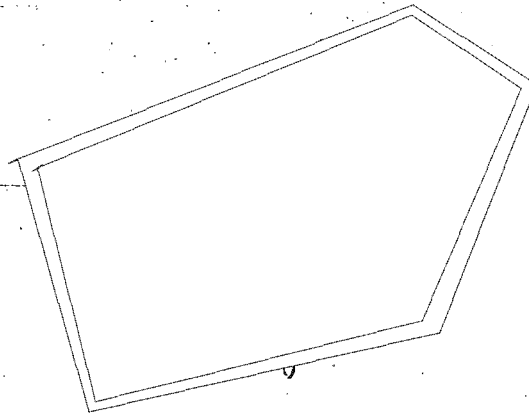

CERTIFICATION

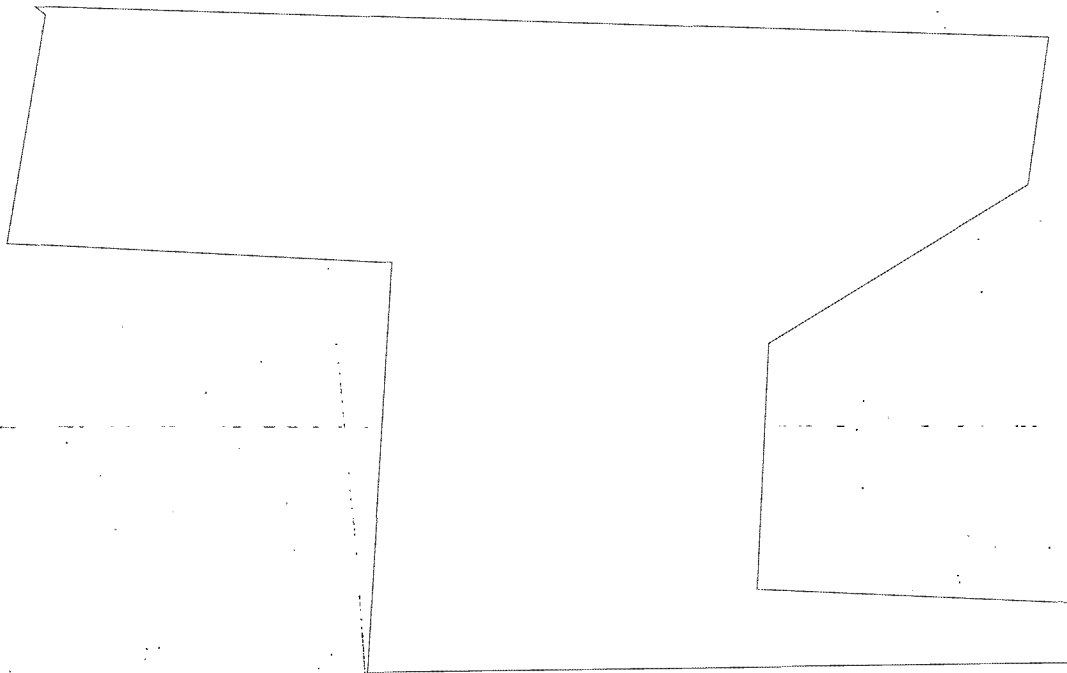

Jeremy K. Benadum 13 May 1969.
JEREMY K. BENADUM (DATE)

CARL SECRETARIAT DISSEMINATION PERSON/UNIT NOTIFIED		CLASSIFIED MESSAGE	TOTAL COPIES	BY	AND/OR INITIALS - SIGN BY		
ADVANCE COPY <input type="checkbox"/> ISSUED <input type="checkbox"/> SLOTTED <input type="checkbox"/> BY: _____ AT: _____ Z DISSEM BY: <u>76</u> PER _____ ACTION: <input type="checkbox"/> RID COPY		SECRET (When Filled In) REPRODUCTION OF THIS COPY PROHIBITED INDEX: <input type="checkbox"/> YES <input type="checkbox"/> NO CLASSIFY TO FILE NO. _____ R-REF TO FILE NO. _____ FILE RID <input type="checkbox"/> REF. TO _____ BRANCH <input type="checkbox"/> DESTROY <input type="checkbox"/> 9-3	1 2 3 4 5		6 7 8 9 10		
			INFO.		FILE. VR.		
			<i>Copy 8</i> <i>#295 CRISO. of CI, of E. 2 spot</i>				

SECRET 130120Z MAY 69 CITE MEXICO CITY 0200

DIRECTOR

RYBAT ADMIN LITEMPO

608
13MAY 69 145660R

REFS: A. DIRECTOR 90663

B. MEXICO CITY 0023 (17 5332)

1. AT TIME PROJECT LITEMPO SUBMITTED FOR RENEWAL IT NOT KNOWN THAT CURTIS RETIRING AS OF 30 JUNE 69. IT STATION'S OPINION THAT IF CURTIS AND BENADUM LEAVE SIMULTANEOUSLY (1 JULY 69), PROBERT WILL LACK TIME TO BUILD-UP RELATIONSHIP WHICH BENADUM HAS HAD FOR [REDACTED] AND CURTIS FOR [REDACTED] YEARS WITH THIS

[REDACTED]

2. FEEL CURTIS DEPARTURE CHANGES PICTURE SUFFICIENTLY TO WARRANT AMENDMENT TO LITEMPO PROJECT TO ALLOW FOR RETENTION

[REDACTED]

[REDACTED]

SECRET

CABLE SECRETARIAT DISSEMINATION PERSONS ONLY NOTIFIED	CLASSIFIED MESSAGE	TOTAL COPIES	ROUTING AND/OR INITIALS (SEE 57)			
ADVANCE COPY <input type="checkbox"/> ISSUED <input type="checkbox"/> SLOTTED <input type="checkbox"/> BY _____ AT _____ Z DISSEM BY _____ PER _____ ACTION _____ <input type="checkbox"/> RID COPY	SECRET <small>(When Filled In)</small> REPRODUCTION OF THIS COPY PROHIBITED INDEX <input type="checkbox"/> YES <input type="checkbox"/> NO CLASSIFY TO FILE NO. _____ REF TO FILE NO. _____ FILE RID <input type="checkbox"/> REF. TO _____ BRANCH <input type="checkbox"/> DESTROY <input type="checkbox"/>	<small>GROUP 1 EXCLUDED FROM AUTOMATIC DOWNGRADING AND DECLASSIFICATION</small>	1	6		
			2	7		
			3	8		
			4	9		
			5	10		
INFO. FILE VR.						

PAGE 2 MEXICO CITY 0200 S E C R E T

3. ON OTHER HAND, STATION CONCERNED WITH TOTAL COSTS OF PROJECT. REQUEST HEADQUARTERS ADVISE STATION IF IT POSSIBLE TO AMEND BENADUM CONTRACT WHICH WOULD KEEP HIM AS CAREER AGENT, BUT AT SALARY IN HAND (AFTER RETIREMENT, FEGLI, TAX ETC.) OF ABOUT \$15,000.00 PER ANNUM. POV ALLOWANCE OF \$600 PER ANNUM AND NO ADDITIONAL BENEFITS, BUT WITH RIGHT ACCEPT OTHER PART-TIME EMPLOYMENT.

4. IF ABOVE POSSIBLE, WILL DISCUSS WITH BENADUM.

5. PLS ADVISE BY CABLE.

May 13 - Per Penroll

SECRET

Currently GI-15⁶ 23,075 (Not paid in field)

<i>Current Income</i>	GRAS	\$1,774.40	
<i>Retirement</i>	115.34		
<i>TAX</i>	456.75		
<i>FEGLI</i>	14.30		
<i>Optical</i>	12.00		
<i> Hosp.</i>	18.78		
<i>Contract Life</i>	12.00		
<i>Total Deduct</i>		629.17	
	NET	\$1,145.23	X 13 pay periods
		\$14,887.99	

Est. pay in field
3800
4300
4243
4243
4243

SECRET

O: Renshan/
IT: WH/Contracts
: 4460
FE: 7 May 1969

MESSAGE NO. 10
TOTAL COPIES

SECRET

ROUTING AND/OR INITIALS - SEEN BY	
1	
2	
3	
4	

FILE SECRETARIAT DISSEMINATION

INDEX NO INDEX RETURN TO _____ BRANCH FILE BILL
 FILE IN CB FILE NO. _____

NPI

4448

10

FILE. NO. 2252, CSFS, DP2, SF, C/10A, MPS/3G

(classification)

(date and time filed)

(reference number)

(page)

SECRET/RYBAT

07 19 44Z MAY 69

CITE DIRECTOR 99663

PRIORITY MEXICO CITY

ADMIN CONTRACTS

- REFS: A. MEXICO CITY 0023 (IN 47116) RYBAT
 B. HMMA-36678
 C. DIRECTOR 84074 RYBAT

1. IN VIEW OF SERVICE PERFORMED BY BENADUM IN THE EARLY 1960'S AND HIS ASSISTANCE IN

[REDACTED]

AS STATION WILL RECOGNIZE, REF A WHICH FOLLOWED REF B (THE PROJECT RENEWAL WHICH ABOLISHED THE POSITION HELD BY BENADUM IN MEXICO) AND FACT HQS HAS NO OTHER CONTRACTUAL REQUIREMENT FOR HIS SERVICES IN MEXICO LIMITS POSSIBLE SOLUTIONS. AT PRESENT THERE APPEARS TWO COURSES OF ACTION OPEN:

- A. TRANSFER ELSEWHERE AS A CAREER AGENT; OR
 B. "DISCONTINUED SERVICE RETIREMENT" AS NOTED IN REF C SINCE BENADUM DOES NOT QUALIFY FOR WOFIRM RETIREMENT UNTIL OCTOBER 1970.

(CONTINUED)

ISSUING OFFICE

COORDINATING OFFICES
SECRET

SECRET
Excluded from automatic
downgrading and
declassification

AUTHENTICATING OFFICER

REPRODUCTION BY OTHER THAN THE ISSUING OFFICE IS PROHIBITED.

COPY NO.

MESSAGE FORM
TOTAL COPIES:

S E C R E T

ROUTING AND/OR INITIALS - SEEN BY	
1	5
2	6
3	7
4	8

TO:
FROM:
INFO:
SUBJECT:

FILE SECRETARIAT DISSEMINATION

INDEX NO INDEX RETURN TO _____ BRANCH FILE RID
 FILE IN: CS FILE NO. _____

PER _____

N
P
Q
FILE, VR.

(classification)

(date and time filed)

(date) (page)
(reference number)

SECRET/RYBAT

CITE DIRECTOR

99663

PRIORITY MEXICO CITY

PAGE 2

7 7

2. HQS BELIEVES IT BEST FOR WOFIRM AND STATION TO NOW COME TO AN AMICABLE PARTING OF THE WAY AND THEREFORE REQUESTS CURTIS' FRANK APPRAISAL OF WHAT EFFECT THE INVOLUNTARY AND POSSIBLY DISGRUNTLED RETIREMENT BENADUM WOULD HAVE ON JOHN A. PROBERT'S FUTURE RELATIONSHIPS



3. HQS ALSO FEELS THAT THE DECISION REGARDING BENADUM SHOULD BE MADE PRIOR TO THE ARRIVAL OF PROBERT AND ALL NECESSARY STEPS BE TAKEN TO EXPEDITE THIS. ACCORDINGLY, CURTIS' COMMENTS AND RECOMMENDATIONS WILL BE MOST APPRECIATED.

4. IN EVENT BENADUM ELECTS TRANSFER AS CAREER AGENT ELSEWHERE HQS NEEDS FOLLOWING:

A. HAVE BENADUM COMPLETE FRQ SOONEST FOR TRANSMITTAL HQS. REASSIGNMENT PREFERENCES TO BE CABLED.

(CONTINUED)

8
4
3
2
1

RELEASING OFFICER

COORDINATING OFFICER

S E C R E T

GROUP 1
 Excluded from automatic
 downgrading and
 declassification

AUTHENTICATING OFFICER

REPRODUCTION BY OTHER THAN THE ISSUING OFFICE

PROHIBITED

COPY VIA

MESSAGE FORM
TOTAL COPIES:

S E C R E T

ROUTING AND/OR INITIALS - SEEN BY			
1		5	
2		6	
3		7	
4		8	

3:
7:
8:

LE SECRETARIAT DISSEMINATION

INDEX NO INDEX RETURN TO _____ BRANCH FILE RID
 FILE IN CS FILE NO. _____

IP:

FILE. VR.

(classification)

(date and time filed)

(reference number)

SECRET/RYPAT

CITE DIRECTOR

99663

PRIORITY MEXICO CITY

PAGE 3

B. IN ANY EVENT REQUEST COMPLETE FITNESS REPORT FOR PAST YEAR ON BENADUM, HAVE HIM SIGN AND FORWARD HQS. SOONEST. CABLE TRANSMITTAL NUMBER.

C. REQUEST STATION FWD COPY MEMO OF 7 APRIL TO BENADUM WITH BENADUM'S MEMO OF 24 APRIL.

5. IN EVENT BENADUM PREFERS TO RETIRE NOW RATHER THAN BE CONSIDERED FOR REASSIGNMENT, THE ONLY METHOD IS THROUGH "DISCONTINUED SERVICE" ON BASIS JOB ABOLISHMENT.

A. RELATED REGULATIONS PROVIDE AN EMPLOYEE WHO IS INVOLUNTARILY SEPARATED IS ENTITLED TO AN IMMEDIATE ANNUITY WHEN, REGARDLESS OF AGE, HAS COMPLETED 25 YEARS OF CREDITABLE SERVICE.

B. REQUEST BENADUM'S COMMENTS AND, IN ANY EVENT, COMPLETE SF-144 "STATEMENT OF PRIOR FEDERAL SERVICE AND MILITARY SERVICE" FOR TRANSMITTAL HQS ASAP.

C. ACCRUED ANNUAL LEAVE NOT A FACTOR IN COMPUTING RETIREMENT AS INDIVIDUAL RECEIVES LUMP SUM PAYMENT FOR CURRENT BALANCE OR

(CONTINUED)

ISSUING OFFICE

COORDINATING OFFICER

S E C R E T

GROUP 1
Excluded from automatic
downgrading and
declassification

AUTHENTICATED
OFFICER

REPRODUCTION BY OTHER THAN THE ISSUING OFFICE IS PROHIBITED.

COPY NO.

MESSAGE FORM
TOTAL COPIES:

SECRET

ROUTING AND/OR INITIALS - SEEN BY		
1		
2		
3		
4		

TO:
FROM:
INFO:
SUBJECT:

ABLE SECRETARIAT DISSEMINATION

INDEX
 NO INDEX
 RETURN TO _____ BRANCH
 FILE RID
 FILE IN CS FILE NO. _____

REF: _____
INFO: _____
FILE, VR, _____

(classification)

(date and time filed)

(office) (reference number)

(date)

SECRET/RYBAT

CITE DIRECTOR 99663

PRIORITY MEXICO CITY

PAGE 4

CARRYOVER AT BEGINNING CURRENT LEAVE YEAR, WHICHEVER LESSER. AVAILABLE RECORDS INDICATE BENADUM CARRYOVER INTO 1969 WAS 560 HOURS.

D. ELIGIBILITY FOR HOME LEAVE CONTINGENT ON REASSIGNMENT.



A. REQUEST REPORTS FOR 1968 BE FORWARDED WITHOUT DELAY AND CABLE TRANSMITTAL NUMBER.

B. IF REPORTS FOR PREVIOUS YEARS NOT READILY AVAILABLE, REQUEST BENADUM PREPARE AND PROVIDE STATION FOR TRANSMITTAL HQS WITHIN REASONABLE PERIOD.

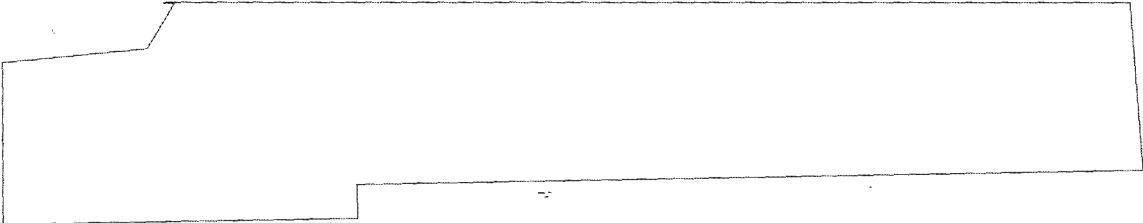

END OF MESSAGE

ISSUING OFFICE

SECRET

GROUP 1
Excluded from automatic
downgrading and
declassification

AUTHENTICATING OFFICER

REPRODUCTION BY OTHER THAN THE ISSUING OFFICE IS PROHIBITED.

REPRODUCTION BY OTHER THAN THE ISSUING OFFICE IS PROHIBITED.

REPRODUCTION BY OTHER THAN THE ISSUING OFFICE IS PROHIBITED.

COPY NO.

8
6
3
2
1

MESSAGE FORM
TOTAL COPIES:

SECRET

ROUTING AND UR INITIALS - DEER BY			
1		5	
2		6	
3		7	
4		8	

TO:
FROM:
SUBJECT:
DATE:

ABLE SECRETARIAT DISSEMINATION

INDEX NO INDEX RETURN TO _____ BRANCH FILED

FILE IN CS FILE NO. _____

DATE:

W
P
O

FILE, VR.

(classification)

(date and time filed)

(olts)

(olts)

reference number)

SECRET/RYPAT

CITE DIRECTOR

9966.3

PRIORITY MEXICO CITY

PAGE 5

WH COMMENTS: A. Attached
B. Submitted Project Renewal

COORD: CSAP
D/OP
C/WH/S
C/WH/1

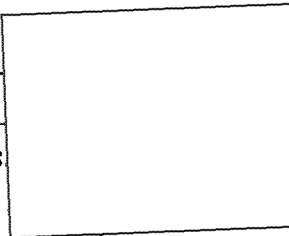

WILLIAM V. BROE
C/WH/D

WILLIAM S. KENEHAN
C. WH CONTRACTS

RELEASING OFFICES

COORDINATING OFFICES

SECRET

GROUP 1
Excluded from automatic
downgrading and
declassification

AUTHENTICATING
OFFICES

REPRODUCTION BY OTHER THAN THE ISSUING OFFICE IS PROHIBITED.

CONV NO.

SECRET

MEMORANDUM FOR: Chief, Audit Staff

SUBJECT : Jeremy K. BENADUM, [REDACTED]

REFERENCE : Audit Staff Memo, Dated 17 March 1969
Subject: Clarification of [REDACTED]
Status of Career Agent, Jeremy K. BENADUM

[REDACTED]

2. The Mexico City Station has been requested to:

[REDACTED]

b. If reports for previous years not readily available, BENADUM is to prepare and provide the Station for transmittal within a reasonable period.

c. If BENADUM [REDACTED]

[REDACTED]

3. Upon receipt from Mexico of the requested information, the Division will take appropriate action.

William V. Bros
Chief
Western Hemisphere Division

Distribution:

Orig. & 1 - C/Audit Staff
1 - SAA/RDS
1 - CE/CPD
1 - Q/Fis
1 - Q/IG
1 - [REDACTED]
1 - [REDACTED]

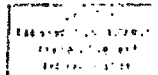

WSRonchan
WH/Contracts
4460
2 May 1969

S E C R E T

SECRET/RVBAT

PRIORITY
MEXICO CITY

ADMIN CONTRACTS

REFS: A. MEXICO CITY 0023 (IN 47116)

B. HMMA-36678

1. UNFORTUNATELY HQS ASSUMED ON RECEIPT OF REF B THAT BENADUM QUALIFIED FOR RETIREMENT UNDER THE WOFIRM RETIREMENT AND DISABILITY SYSTEM. HOWEVER, AFTER A CAREFUL REVIEW IT WAS NOTED THAT HE DOES NOT HAVE THE REQUIRED TEN RPT TEN YEARS SERVICE WITH WOFIRM AND RETIREMENT WOULD NECESSARILY BE UNDER CIVIL SERVICE. BENADUM, AS CITED PARA 2 REF A, IS CORRECT IN THAT RETIREMENT WOULD BE INVOLUNTARY. IN RETROSPECT THE STATION HAD NO AUTHORIZATION TO INFORM BENADUM HE WOULD BE RETIRED EFFECTIVE 30 JUNE, UNLESS STATION MEMO TO BENADUM CONCERNING HIS RETIREMENT WAS IN CONTEXT TO THE ABOLISHMENT OF HIS POSITION WITH THE REDUCTION OF THE LITEMPO PROJECT AND SINCE THE STATION HAD NO OTHER REQUIREMENT FOR HIS SERVICES HE MIGHT PREFER CONSIDER "DISCONTINUED SERVICE RETIREMENT" RATHER THAN TRANSFER ELSEWHERE AS A CAREER AGENT. REQUEST STATION FORWARD COPY MEMO OF 7 APRIL TO BENADUM WITH BENADUM'S MEMO OF 24 APRIL. (CONTINUED)

SECRET

SECRET/RYPAT

PRIORITY MEXICO CITY PAGE 2

2. IN VIEW REFS, UNABLE TO UNDERSTAND WHY OR WHERE BENADUM COULD BE USED AS STATION SUGGESTS IN PARA 3 REF A AS [REDACTED] WHICH APPEARS CONTRADICTORY TO NO REQUIREMENT FOR SERVICES AS CAREER AGENT.

3. AS STATION HAS NO APPARENT JOB COMMENSURATE WITH BENADUM'S GRADE LEVEL AND EXPERIENCE AND IN VIEW HIS [REDACTED] HQS THEREFORE CONSIDERING BENADUM FOR REASSIGNMENT.

A. REQUEST STATION CONTACT BENADUM AND HAVE HIM COMPLETE FRQ SOONEST FOR TRANSMITTAL HQS. REASSIGNMENT PREFERENCES TO BE CABLED.

B. REQUEST STATION COMPLETE FITNESS REPORT FOR PAST YEAR ON BENADUM, HAVE HIM SIGN AND FORWARD HQS SOONEST. CABLE TRANSMITTAL NUMBER.

[REDACTED]

A. REQUEST REPORTS FOR 1968 BE FORWARDED WITHOUT DELAY AND CABLE TRANSMITTAL NUMBER.

(CONTINUED)

S E C R E T

SECRET/RVDAT

PRIORITY MEXICO CITY

PAGE 3

B. IF REPORTS FOR PREVIOUS YEARS NOT READILY AVAILABLE, REQUEST BENADUM PREPARE AND PROVIDE STATION FOR TRANSMITTAL HQS WITHIN REASONABLE PERIOD.

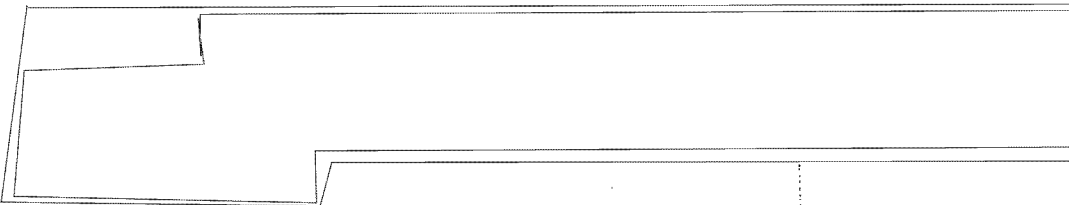

5. REQUEST ADVISE BENADUM:

A. ALTHOUGH AGREE THAT SHOULD HE WANT TO RETIRE, THE ONLY METHOD IS THROUGH "DISCONTINUED SERVICE" ROUTE CONSIDERING HE MAY PREFER RETIREMENT TO REASSIGNMENT. REQUEST HIS COMMENTS AND, IN ANY EVENT, COMPLETE SF-144 "STATEMENT OF PRIOR FEDERAL SERVICE" FOR TRANSMITTAL HQS ASAP.

B. ACCRUED ANNUAL LEAVE NOT A FACTOR IN COMPUTING RETIREMENT AS INDIVIDUAL RECEIVES LUMP SUM PAYMENT FOR CURRENT BALANCE OR CARRYOVER AT BEGINNING OF LEAVE YEAR WHICHEVER LESSER. AVAILABLE RECORDS

(CONTINUED)

SECRET

SECRET/RVBAT

PRIORITY MEXICO CITY PAGE 4

INDICATE BENADUM HAD CARRYOVER OF 560 HOURS.

END OF MESSAGE

WH COMMENTS: A. Attached
B. Submitted Project Renewal

COORD:

C/WH/I

CSAP

D/OP

C/WH/SS

WILLIAM V. BROOK
C/WH/D

WILLIAM S. RENEHAN
C/WH/CONTRACTS

DISPATCH

CLASSIFICATION
S E C R E T
RYBAT

PROCESSING ACTION

MARKED FOR INDEXING

TO
Chief, WH Division

XX

NO INDEXING REQUIRED

FROM
Chief of Station, Mexico City

ONLY QUALIFIED DESK
CAN JUDGE INDEXING

SUBJECT
Jeremy K. BENADUM Retirement

NO/PHILM

ACTION REQUIRED - REFERENCES

ACTION REQUIRED: For Your Information

REFERENCE : MEXICO CITY-0023, 29 April 1969

Forwarded herewith in original and a signed carbon
is the 24 April 1969 memorandum written by Jeremy K.
BENADUM and mentioned in Reference.

Willard C. Curtis
Willard C. CURTIS

Attachment:
As stated, h/w

Distribution:
Orig and 2 - Chief, WHD, w/att

CLASSIFICATION TO

DISPATCH SYMBOL AND NUMBER

HMMT-9686

30 April 1969

CLASSIFICATION
S E C R E T
RYBAT

POST THE SYMBOL

201-287227

México, D.F.

24 April, 1969

SUBJECT: Involuntary Retirement

1. A desk officer from Headquarters visited the México City Station during mid-November, 1968. While here, the visiting officer talked with the writer for approximately one hour regarding the operation of the Litempo project and writer's plans for the future. The following points were discussed:

(a) The fact that the project was considered to be an important and successful one.

(b) Writer was specifically asked if he had any plans for an early retirement. Writer replied in the negative. The visiting officer indicated complete satisfaction with writer's desire to continue in the service, and noted that it would be

[REDACTED]

(c) When the visiting officer asked whether the writer had ever visited Headquarters during his career with the service, and found that he had not done so, the officer asked whether writer could arrange to visit Headquarters for a week or ten days during his next home leave, which would take place in [REDACTED] 1969. Writer indicated that he would be most pleased to do so.

2. Based on the foregoing, writer made plans to proceed to the United States on home leave in [REDACTED] 1969, to return in [REDACTED] 1969. Since such matters cannot be handled on short notice, writer has already rented a house in San Francisco, California for the period in question.

3. This is where matters stood, when, on 7 April, last, writer was advised that he would be retired, effective 30 June, 1969, in accordance with various changes of policy. He was also asked to confirm in writing that he is in accord with the plan to place him on retired status as of 30 June, next.

4. While the reasoning behind what appears to be a complete reversal of policy, vis-a-vis the writer, may be crystal clear to the responsible officials at Headquarters, writer is at a complete loss to understand.

For the writer to indicate his agreement with a plan which appears to him to be arbitrary, short-sighted and irrational, would be completely out of character for a person who has spent almost thirty years in the intelligence field, and has a justifiable pride in his status as a professional intelligence officer. As a professional, writer also realizes when the handwriting, however illegible it might be, is on the wall, and, that if the decision has already been made to retire him involuntarily, then retired he will be --- involuntarily. Little as it may matter, writer desires to emphasize that nothing in this memorandum should be construed to indicate writer's personal accord or approval.

5. According to writer's records, as of 30 June, next, he will have completed the following government service:

	<u>Yrs.</u>	<u>Mos.</u>	<u>Days</u>
(a) Military: 2nd. Lt., 30th U.S. Infantry; Presidio, San Francisco, 26 Oct., 1939 to 31 July, 1940.....	9		6
(b) Special Agent, 12 Aug., 1940 to 31 October, 1960.....	20	2	18
(c) Career Agent, 1 Nov., 1960 to 30 June, 1969.....	8		8
(d) Accumulated A/L as of 30 June, 1969, - 656 hrs.		3	22
Total Service	29	11	16

Writer desires to complete thirty years' service, and requests that the effective date for his involuntary retirement be set accordingly.

6. Home Leave: While writer readily understands the rationale of a ruling preventing the taking of home leave at government expense within two years of voluntary retirement, he does not see that the interests of fairness, justice or decency are being served in attempting to apply the same ruling to writer's involuntary retirement. As a matter of possible historical interest, writer desires to point out that, when he joined the service in 1940, he voluntarily gave up the home leave which he had earned with the (3 years). Writer has

taken home leave in 1962, 1964 and 1966, in accordance with regulations. In line with what appeared to be Agency policy as of November, 1968, writer has made plans for home leave from [redacted] 1969. Writer feels most strongly that he and his family should be allowed to take this leave at government expense.

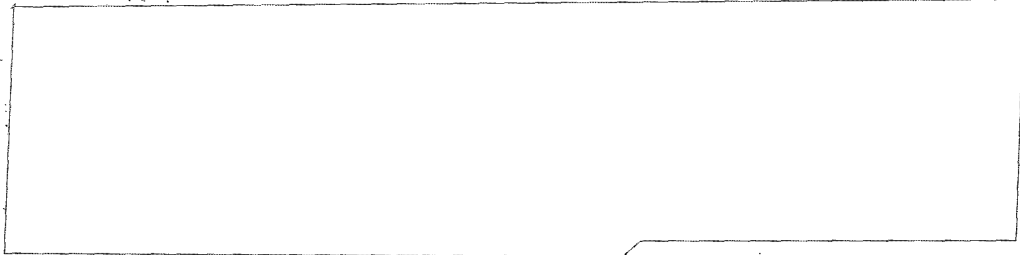

8. In conclusion, writer wishes to state that he has thoroughly enjoyed his association with the Agency during the past nine years, and is proud of his part in the accomplishments of [redacted]. Owing to the nature of writer's position, his personal contacts have been largely limited to the personnel [redacted]. The writer has the highest professional and personal regard for the Chief of Station, with whom he has been privileged to serve, as well as the highly competent case officers who have worked with writer on the project.

It is a source of great satisfaction and pride to the writer to have known and worked with a truly great American, Mr. Allen W. Dulles, whom the "San Francisco Chronicle" (generally a hostile critic of the Agency) described posthumously as "...The most creative, powerful and eminent U.S. intelligence officer of modern times". And, as one's career comes to a close, the words of President Nixon, in describing Mr. Dulles' great contribution to his country, have a very particular significance: "...In the nature of his task, his achievements were known to only a few. But, because of him, the world is a safer place today".

Jimmy K. Landon

George F. Munroe

CS-1516
21469

(DATE)

1471

SENDER WILL CHECK CLASSIFICATION TOP AND BOTTOM			
UNCLASSIFIED	CONFIDENTIAL	SECRET	
OFFICIAL ROUTING SLIP			
TO	NAME AND ADDRESS	DATE	INITIALS
1	[redacted]		[redacted]
2	C/CPD		
3			
4			
5			
6			
ACTION	DIRECT REPLY	PREPARE REPLY	
APPROVAL	DISPATCH	RECOMMENDATION	
CONSENT	FILE	RETURN	
CONCURRENCE	INFORMATION	SIGNATURE	
Remarks:			
<p>According to [redacted], this is not as big a problem as it appears. [redacted] alleges that COG could have handled better. [redacted] is on top of it and will let us know if anything serious develops. [redacted]</p> <p><i>Don't wait to hear further</i></p> <p style="text-align: center;">SECRET</p>			
FOLD HERE TO RETURN TO SENDER			
FROM NAME ADDRESS AND PHONE NO			DATE
APPROVED BY (NAME AND TITLE)			DATE
UNCLASSIFIED	CONFIDENTIAL	SECRET	

CABLE SECRET/SECRET DISSEMINATION
PERSON COPY NOTICES

CLASSIFIED MESSAGE

TOTAL COPIES

ROUTED AND/OR INITIALS - SEEN BY

SECRET

(When Filled In)

GROUP
FROM THE FILE OFFICE
DATE OF
RECLASSIFICATION

1		9	
2		7	
3		8	
4		9	
5		10	

REPRODUCTION OF THIS COPY FROM A TEC

INDEX YES NO

CLASSIFY TO FILE NO _____

X-REF TO FILE NO _____

FILE NO YES TO _____

BRANCH

DESTROY SIG.

ADVANCE COPY ISSUED SLOTTED

BY _____ AT _____ Z

DISSEM BY 25

ACTION RID COPY

INFO
FILE VR

D/OP, C/CI, C/MPS/BG
C/FE-2, C/CS-2

SECRET 291907Z APR 69 CITE MEXICO CITY 2003

DIRECTOR

RYSAT ADMIN PERS

REF HKNA-36678

23 Apr 69 IN 47116

4

1. AS INDICATED IN REFERENCE AND DISCUSSED BY THE COS DURING HIS RECENT VISIT TO HEADQUARTERS, STATION PLANNED ASK JEREMY N. BENADUM, CAREER AGENT AND OUTSIDE CASE OFFICER FOR LITEMPO PROJECT, TO RETIRE FROM GOVERNMENT SERVICE EFFECTIVE 30 JUNE 69. THIS WAS DONE IN WRITING ON 7 APRIL 69.

2. BENADUM HAS WRITTEN MEMORANDUM DATED 24 APRIL 69 IN WHICH HE INDICATES THAT HE DOES NOT DESIRE TO RETIRE AND THAT ANY ACTION ALONG THESE LINES SHOULD BE CONSIDERED "INVOLUNTARY" ON HIS PART. JKB ALSO INDICATED THAT WITH ACCURED ANNUAL LEAVE HE WILL LACK ABOUT MONTH IN COMPLETING FULL 32 YEARS SERVICE AS OF 30 JUNE AND ASKED THAT HE BE KEPT ON BOARD UNTIL FULL 30 YEARS ARE COMPLETED.

3. JKB REQUESTS THAT HE BE ALLOWED TO TAKE HOME LEAVE AT GOVERNMENT EXPENSE. HE INDICATED HIS UNDERSTANDING WITH REGULATION ABOUT NO HOME LEAVE WITHIN TWO YEARS OF VOLUNTARY RETIREMENT BUT SAID THAT HE CANNOT AGREE WITH THIS WHEN RETIREMENT

SECRET

SECRETARIAT DISSEMINATION RESPONSIBILITY NOTIFIED	CLASSIFIED MESSAGE	TOTAL COPIES	ROUTING AND/OR INITIALS - SEEN BY			
	SECRET (When Filled In)	GROUP 1 EXCLUDED FROM AUTOMATIC DOWNGRADING AND DECLASSIFICATION	1		8	
	REPRODUCTION OF THIS COPY PROHIBITED		2		7	
ADVANCE COPY <input type="checkbox"/> ISSUED <input type="checkbox"/> SLOTTED	INDEX <input type="checkbox"/> YES <input type="checkbox"/> NO		3		6	
BY _____ AT _____ 2	CLASSIFY TO FILE NO _____		4		9	
CLASSIFIED BY _____ PER _____ S _____	REF TO FILE NO _____		5		10	
ACTION _____	FILE TO <input type="checkbox"/> RET TO _____	BRANCH <input type="checkbox"/>				
<input type="checkbox"/> RID COPY	INFO	DESTROY <input type="checkbox"/> SIG.				
	FILE NO.					

PAGE 2 MEXICO CITY 0023 S E C R E T

13 "INVOLUNTARY", THE STATION WISHES TO INDICATE THAT JKB WAS REFUSED NORMAL HOME LEAVE DURING THE SUMMER OF 68 BECAUSE OF STUDENT PROBLEMS.

4. THE STATION REQUESTS THAT FAVORABLE CONSIDERATION BE GIVEN TO ITEMS MENTIONED IN PARAS 2 AND 3 ABOVE. PLS ADVISE.

5. JKB HAS INDICATED HIS WILLINGNESS TO REMAIN ACTIVE ON CONTRACT BASIS. THE STATION BELIEVES THAT CONSIDERABLE BENEFIT COULD ACCURE BY RETAINING JKB. PLS ADVISE IF HEADQUARTERS IS INTERESTED IN CONTRACTING JKB AND CONDITIONS SO THAT THEY MAY BE DISCUSSED WITH HIM. (HE WANTS 15,000 PER ANNUM PLUS 50.00 PER MONTH FOR USE OF POV.)

6. POUCHING COPIES OF MEMORANDUM PREPARED BY JKB WHICH IS DATED 24 APRIL 69.

7. FILES NONE.

S E C R E T

SECRET

STATEMENT OF PRIOR FEDERAL CIVILIAN AND MILITARY SERVICE

IMPORTANT: This form is used only to establish creditability of service, which is otherwise not verified in the Official Personnel Folder, for leave and reduction in force purposes. The employee will complete Part I and the Personnel Office Parts II and III. When this form is used as a cumulative record or the employee's affidavit is used in the absence of a verified record, it must be filed on the right side of the Official Personnel Folder.

PART I - EMPLOYEE'S STATEMENT

1. NAME (Last, first, initial) Mr. Mrs. Miss 2. BIRTH DATE (Mo., Day, Yr.)
 MUNRO, GEORGE F.

3. LIST THE FOLLOWING INFORMATION ABOUT ANY CLAIMED FEDERAL OR DISTRICT OF COLUMBIA SERVICE YOU HAVE HAD WHICH HAS NOT YET BEEN VERIFIED (Do not include military service.) IF ANY OF THIS SERVICE WAS PART-TIME, WAE, OR INTERMITTENT, NOTE THIS UNDER "TYPE OF APPOINTMENT."

NAME AND LOCATION OF AGENCY	FROM			TO			TYPE OF APPOINTMENT (If known)
	YEAR	MONTH	DAY	YEAR	MONTH	DAY	
<input checked="" type="checkbox"/> FEDERAL BUREAU OF INVESTIGATION CIA	40	8	22	60	10	31	SPECIAL AGENT CAREER AGENT
<i>S.C.D. NOV. 3 1959 (P.O. CPD) (P.O. OFF. STAFF) (6/10/59)</i>							

4. LIST PERIODS OF ANY CLAIMED ACTIVE SERVICE YOU HAVE HAD IN ANY BRANCH OF THE ARMED FORCES OF THE UNITED STATES, INCLUDING ACTIVE DUTY AS A RESERVIST, WHICH HAS NOT YET BEEN VERIFIED. (Also list Merchant Marine service, if interrupted service shown in Item 3.)

BRANCH	FROM			TO			DISCHARGE (Hon. or Dishon.)
	YEAR	MONTH	DAY	YEAR	MONTH	DAY	
<input checked="" type="checkbox"/> US ARMY (2nd. Lt., 30th U.S. Inf., Presidio, San Francisco, California)	39	10	28	40	7	31	HONORABLE

5. DURING PERIODS OF EMPLOYMENT SHOWN IN ITEM 3, DID YOU HAVE A TOTAL OF MORE THAN 6 MONTHS ABSENCE WITHOUT PAY DURING ANY ONE CALENDAR YEAR? (If YES, list following interval(s).) YES NO

TYPE IF KNOWN (L.W.O.P., Furl., Susp., A.W.O.L.)	FROM			TO			TOTAL		
	YEAR	MONTH	DAY	YEAR	MONTH	DAY	YEARS	MONTHS	DAYS
<input checked="" type="checkbox"/> No									

6. DO YOU CLAIM ANY TYPE OF VETERAN PREFERENCE WHICH HAS NOT BEEN VERIFIED? Yes No If "Yes," check one of the following statements if it applies to you:
 I CLAIM PREFERENCE AS THE WIFE OF A DISABLED VETERAN.
 I CLAIM PREFERENCE AS THE MOTHER OF A DECEASED OR DISABLED VETERAN.
 I CLAIM PREFERENCE AS THE UNMARRIED WIDOW OF A VETERAN.

7. TO BE EXECUTED BEFORE A NOTARY PUBLIC OR OTHER PERSONS AUTHORIZED TO ADMINISTER OATHS.
 I swear (or affirm) that the above statements are true to the best of my knowledge and belief.
 Date: 12/16/59 George F. Munro
(Signature)

Subscribed and sworn to (or affirmed) before me on this _____ day of _____ 19____ at _____ (City) _____ (State)

SEAL

NOTE: If oath is taken before a Notary Public, the date of expiration of his Commission must be shown.

SECRET

CABLE

D R A F T #2

1 May 1969

PRIORITY MEXICO CITY

RYBAT ADMIN CONTRACTS LITEMPO

REFS: A. MEXICO CITY 0023 (IN 47116)
B. HMMA-36678

1. UNLESS STATION MEMO TO JEREMY K. BENADUM CONCERNING RETIREMENT WAS IN CONTEXT THAT DUE TO REDUCTION OF LITEMPO PROJECT AND THUS ABOLISHMENT OF HIS POSITION AND AS NO OTHER STATION REQUIREMENT FOR HIS SERVICES, HE MIGHT PREFER CONSIDER "DISCONTINUED SERVICE RETIREMENT" RATHER THAN TRANSFER, STATION HAD ~~NOT BEEN AUTHORIZED~~ TO INFORM BENADUM HE WOULD BE RETIRED EFFECTIVE 30 JUNE. BENADUM DOES NOT QUALIFY FOR RETIREMENT UNDER WOFIRM RETIREMENT AND DISABILITY SYSTEM AS DOES NOT HAVE REQUIRED TEN RPT TEN YEARS SERVICE WITH ORGANIZATION AND RETIREMENT WOULD BE UNDER CIVIL SERVICE. BENADUM, AS CITED PARA 2 REF A, IS CORRECT IN THAT RETIREMENT WOULD BE INVOLUNTARY. REQUEST FORWARD COPY STATION MEMO OF 7 APRIL TO BENADUM WITH BENADUM'S MEMO OF 24 APRIL.

2. IN VIEW REFS, UNABLE TO UNDERSTAND WHY OR WHERE BENADUM COULD BE USED AS STATION SUGGESTS IN PARA 5 REF A AS WHICH APPEARS CONTRADICTORY TO NO REQUIREMENT FOR SERVICES AS CAREER AGENT.

3. AS STATION HAS NO APPARENT JOB COMMENSURATE WITH BENADUM'S GRADE LEVEL AND EXPERIENCE AND IN VIEW HIS LONG STAY MEXICO, HQS THEREFORE CONSIDERING BENADUM FOR REASSIGNMENT.

A. REQUEST STATION CONTACT BENADUM AND HAVE HIM COMPLETE FRQ SOONEST FOR TRANSMITTAL HQS. REASSIGNMENT PREFERENCES TO BE CABLED.

SECRET

SECRET

B. REQUEST STATION COMPLETE FITNESS REPORT FOR PAST YEAR ON BENADUM, HAVE HIM SIGN AND FORWARD HQS SOONEST. CABLE TRANSMITTAL NUMBER.

[REDACTED]

A. REQUEST REPORTS FOR 1968 BE FORWARDED WITHOUT DELAY AND CABLE TRANSMITTAL NUMBER.

B. IF REPORTS FOR PREVIOUS YEARS NOT READILY AVAILABLE, REQUEST BENADUM PREPARE AND PROVIDE STATION FOR TRANSMITTAL HQS WITHIN REASONABLE PERIOD.

[REDACTED]

5. REQUEST ADVISE BENADUM:

A. ALTHOUGH AGREE THAT SHOULD HE WANT TO RETIRE, THE ONLY METHOD IS THROUGH "DISCONTINUED SERVICE" ROUTE CONSIDERING HE MAY PREFER RETIREMENT TO REASSIGNMENT. REQUEST HIS COMMENTS AND, IN ANY EVENT, COMPLETE SF-144 "STATEMENT OF PRIOR FEDERAL SERVICE" FOR TRANSMITTAL HQS ASAP.

B. ACCRUED ANNUAL LEAVE NOT A FACTOR IN COMPUTING RETIREMENT AS INDIVIDUAL RECEIVES LUMP SUM PAYMENT FOR CURRENT BALANCE OR CARRYOVER AT BEGINNING OF LEAVE YEAR WHICHEVER LESSER. AVAILABLE RECORDS INDICATE BENADUM HAD CARRYOVER OF 560 HOURS.

SECRET

D R A F T

1 May 1969

SECRET

CABLE TO MEXICO CITY

RYBAT ADMIN CONTRACTS LITEMPO

REFS: A. MEXICO CITY 0023 (IN 47116)
B. HMMA-36678

1. UNLESS STATION MEMO TO JEREMY K. BENADUM CONCERNING RETIREMENT WAS IN CONTEXT THAT DUE TO REDUCTION OF LITEMPO PROJECT AND NO OTHER STATION REQUIREMENT FOR HIS SERVICES, HE MIGHT PREFER TO RETIRE RATHER THAN TRANSFER, STATION HAD NOT BEEN AUTHORIZED TO INFORM BENEDUM HE WOULD BE RETIRED EFFECTIVE 30 JUNE. REQUEST FORWARD COPY STATION MEMO OF 7 APRIL WITH BENADUM'S MEMO OF 24 APRIL.

2. IN VIEW REFS, UNABLE TO UNDERSTAND WHY OR WHERE BENADUM COULD BE USED AS STATION SUGGESTS IN PARA 5 REF A AS [REDACTED] WHICH APPEARS CONTRADICTORY TO NO REQUIREMENT FOR SERVICES AS CAREER AGENT.

3. AS STATION HAS NO APPARENT JOB COMMENSURATE WITH BENADUM'S GRADE LEVEL AND EXPERIENCE AND IN VIEW HIS [REDACTED] HQS THEREFORE CONSIDERING BENADUM FOR REASSIGNMENT.

A. REQUEST STATION CONTACT BENADUM AND HAVE HIM COMPLETE FHQ SOONEST FOR TRANSMITTAL HQS. REASSIGNMENT PREFERENCES TO BE CABLED.

B. REQUEST STATION COMPLETE FITNESS REPORT FOR PAST YEAR ON BENADUM, HAVE HIM SIGN AND FORWARD HQS SOONEST. CABLE TRANSMITTAL NUMBER.

SECRET

SECRET

4.

A. REQUEST REPORTS FOR 1968 BE FORWARDED WITHOUT DELAY AND CABLE TRANSMITTAL NUMBER.

B. IF REPORTS FOR PREVIOUS YEARS NOT READILY AVAILABLE, REQUEST BENADUM PREPARE AND PROVIDE STATION FOR TRANSMITTAL HQS WITHIN REASONABLE PERIOD.

retirement 5. REQUEST ADVISE BENADUM: *NOT WANT*
method of through *Although agree that should be want to retire, the only*
method of through *HE NOT BEING INVOLUNTARILY RETIRED, IF HE DESIRES*
method of through *RETIRE, NECESSARY THAT HE SUBMIT MEMO REQUEST AND ALSO COMPLETE*
and, in any event, complete

SF-144 "STATEMENT OF PRIOR FEDERAL SERVICE" FOR TRANSMITTAL HQS *ASAP*.

B. ACCRUED ANNUAL LEAVE NOT A FACTOR IN COMPUTING RETIREMENT AS INDIVIDUAL RECEIVES LUMP SUM PAYMENT FOR CURRENT BALANCE OR CARRYOVER AT BEGINNING OF LEAVE YEAR WHICHEVER LESSER. AVAILABLE RECORDS INDICATE BENADUM HAD CARRYOVER OF 560 HOURS.

C. ELIGIBILITY FOR HOME LEAVE CONTINGENT ON REASSIGNMENT.

D. CURRENT POLICY EMPLOYMENT OF WOFIRM ANNUITANTS PRECLUDES REEMPLOYMENT UNDER CONTRACT EXCEPT DUE TO CRITICAL REQUIREMENTS WHICH COULD NOT OTHERWISE BE FILLED. THIS NOT APPLICABLE MEXICO *due to station reductions*.

END OF MESSAGE

SECRET

SECRET

- WII COMMENTS: A. Attached
B. Submitted Project Renewal

COORD:

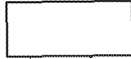

C/WII/1

CSPS

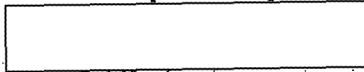

DIPERS

SECRET

SECRET

17 March 1969

MEMORANDUM FOR: Chief, WH Division

THROUGH : Deputy Director for Plans

SUBJECT : Clarification of [REDACTED]
of Career Agent Jeremy K. BENADUM

[REDACTED]

[REDACTED]

Please notify this office of the results of this review.

[REDACTED]

Chief, Audit Staff

Distribution:

- Orig. & 1 - C/WH Div
- 1 - SSA/DUS
- 1 - OP/CFD
- 1 - C/Fin
- 1 - O/IG

SECRET

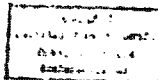

13 March 1969

MEMORANDUM FOR: Chief, WH Division

THROUGH : Deputy Director for Plans

SUBJECT : Clarification of
of Career Agent Jeremy K. BEHADUM
~~and his assignments~~

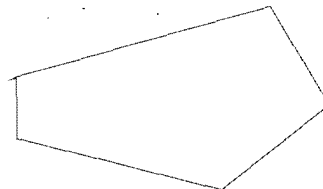
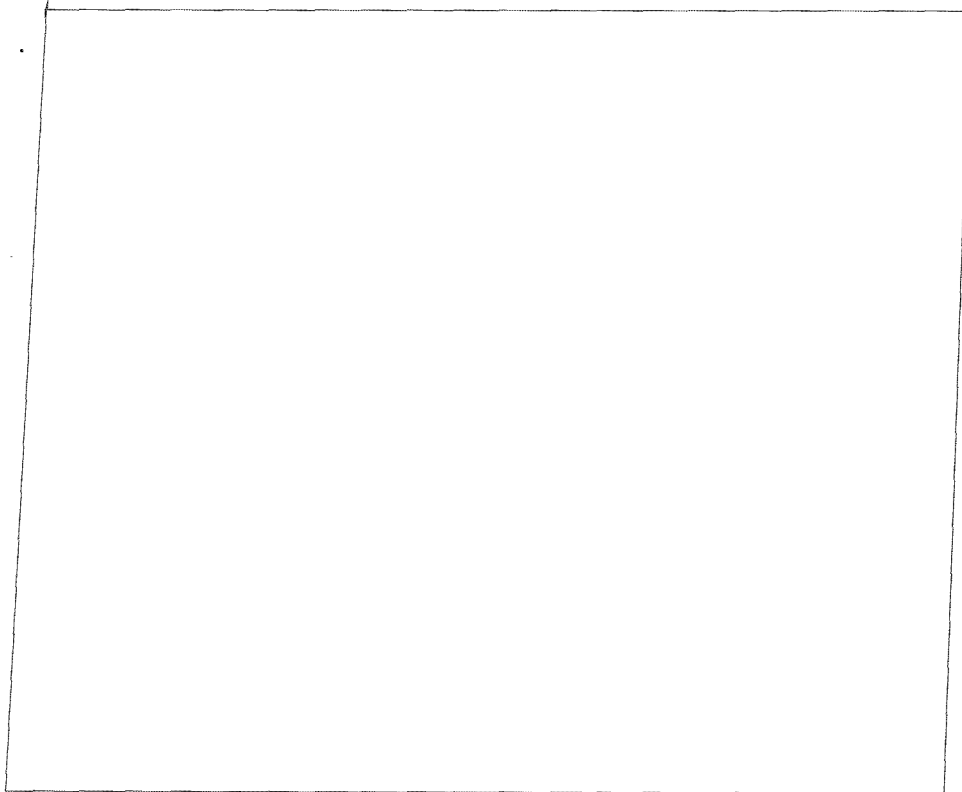

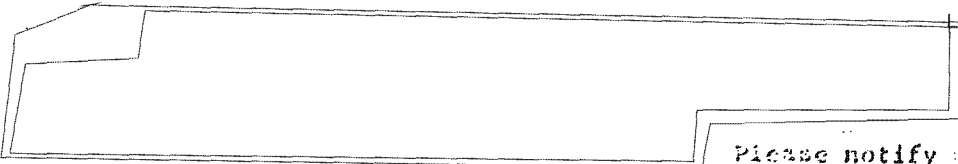
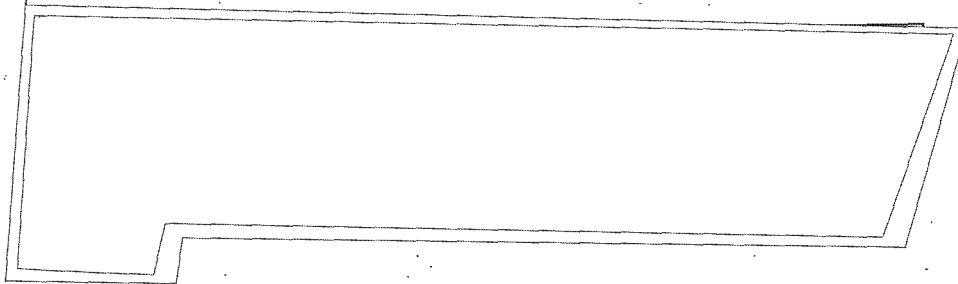

Please notify

this office of the results of this review.



Distribution:

- Orig. & 1 - CH/WH Div
- 1 - SSA/DOS
- 1 - OP/CPD
- 1 - O/PIn
- 1 - O/IG
- 1 - WH Div. File
- 1 - Hqtrs. Chrono File
- 1 - Follow-up

KM:ps

CLASSIFIED MESSAGE		TOTAL COPIES	INITIALS	
CLASSIFIED SECRET (When Filled In)		14	1	6
REPRODUCTION OF THIS COPY PROHIBITED			2	7
INDEX <input type="checkbox"/> YES <input type="checkbox"/> NO			3	
CLASSIFY TO FILE NO _____			4	
R-REF TO FILE NO _____			5	10
FILE NO <input type="checkbox"/> RET TO _____				
BRANCH <input type="checkbox"/> DESTROY <input type="checkbox"/> SIG.				
INFO FILE VR. <i>R/AN, CCST, COPS, CCST</i>				

ADVANCE COPY ISSUED SLOTTED
 BY _____ AT _____ Z
 DISSEM BY *ZS* PER _____
 ACTION: *517* *W/18* RID COPY

SECRET 252257Z NOV 68 CITE MEXICO CITY 8172

DIRECTOR
LITEMPO

25 Nov 68 141479
Carroll *m*

- JEREMY K. BENADUM WILL BE ON ANNUAL LEAVE FROM 29 NOVEMBER THROUGH 12 DECEMBER 68. PLANS DEPART MEXICO CITY ON 29 NOV VIA WESTERN FLIGHT 624 TO SAN FRANCISCO AND RETURN MEXICO CITY VIA WESTERN FLIGHT 627 ON 12 DEC. WHILE IN SAN FRANCISCO CAN BE REACHED AT IDEN A OR B.
- BENADUM PLANS HAVE COMPLETE PHYSICAL EXAM WHILE ON LEAVE.
- FILE: 50-6-91/2; 201-227227

SECRET

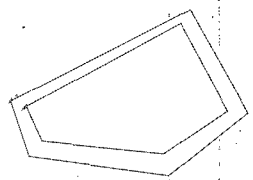

SECRET

FILE SECURITY DISSEMINATION CLASSIFIED MESSAGE TOTAL COPIES 14
 PERMANENT SECURITY

SECRET
 (When Filled In)

ADVANCE COPY ISSUED

BY _____

DISSEM BY *78* ACTION *WHS* INFO END COPY

REPRODUCTION OF THIS COPY PROHIBITED

INDEX YES NO

CLASSIFY TO FILE NO _____

A REF TO FILE NO _____

FILE NO REF TO _____ BRANCH DESTROY SIG

FILE NO *P-1/JAN, COSZ, OAPS, [REDACTED]*

1		
2		
3		
4		
5		

SECRET 252055Z NOV 68 CITE MEXICO CITY 8173

DIRECTOR

25 NOV 68 IN 41473

LITENFO

REF: MEXICO CITY 8172 (w 41479)

D

1. IDENTITY A: MRS. [REDACTED] (MOTHER-IN-LAW)

[REDACTED]

IDENTITY B: MRS. [REDACTED] (SISTER)

[REDACTED]

2. FILES: ²⁰¹⁻²⁸⁷²²⁷ ~~62-241144-114~~ 50-6-91/2

SECRET

SECRET

MESSAGE FORM
TOTAL COPIES

14

SECRET

SENDING AND DE INITIALS (SEE KEY)

1	5
2	7
3	9
4	0
5	10

TO: [Redacted]
FROM: FINANCE
2129
DATE: 1 APRIL 1968

ABLE SECRETARIAT DISSEMINATION

INDEX DESTROY RETURN TO _____ BRANCH FILE BID

BY 25 PER _____

NO INDEX FILE IN CS FILE NO.

COMP: OF2 RID COPY

INFO: FILE . VR WINZ, OPL

SECRET

4 00 36 Z

CITE DIRECTOR 88537

TO [] MEXICO CITY

DUE TO ELUTION OF OPTIONAL FEELI EFF. 3/10/68, PAY JEREMY
K. BENADIM AND T/A TO HEADQUARTERS A NET OF \$1071.62 FOR PERIOD
3/10-4/6/68 AND EACH SUBSEQUENT PERIOD. SEE STATEMENT OF
EARNINGS AND DEDUCTIONS FOR BREAKDOWN.

END OF MESSAGE

WIN/contacts

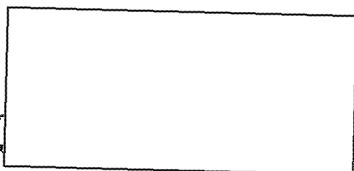

ISSUING OFFICE

REPRODUCTION BY OTHER THAN THE ISSUING OFFICE IS PROHIBITED

**ELECTION, DECLINATION, OR WAIVER
OF LIFE INSURANCE COVERAGE**
FEDERAL EMPLOYEES GROUP LIFE INSURANCE PROGRAM

**IMPORTANT
AGENCY INSTRUCTIONS
ON BACK OF ORIGINAL**

TO COMPLETE THIS FORM—

- 1 FOLLOW THESE GENERAL INSTRUCTIONS:**
- Read the back of the "Duplicate" carefully before you fill in the form.
 - Fill in BOTH COPIES of the form. Type or use ink.
 - Do not detach any part.

2 FILL IN THE IDENTIFYING INFORMATION BELOW (please print or type):

NAME (last)	(first)	(middle)	DATE OF BIRTH (month, day, year)	SOCIAL SECURITY NUMBER
SENADUM	JEREMY	K.	<input type="text"/>	<input type="text"/>
EMPLOYING DEPARTMENT OR AGENCY			LOCATION (City, State, ZIP Code)	

3 MARK AN "X" IN ONE OF THE BOXES BELOW (do NOT mark more than one):

Mark here if you **WANT BOTH** optional and regular insurance

(A)

ELECTION OF OPTIONAL (IN ADDITION TO REGULAR) INSURANCE

I elect the \$10,000 additional optional insurance and authorize the required deductions from my salary, compensation, or annuity to pay the full cost of the optional insurance. This optional insurance is in addition to my regular insurance.

Mark here if you **DO NOT WANT** OPTIONAL but do want regular insurance

(B)

DECLINATION OF OPTIONAL (BUT NOT REGULAR) INSURANCE

I decline the \$10,000 additional optional insurance. I understand that I cannot elect optional insurance until at least 1 year after the effective date of this declination and unless at the time I apply for it I am under age 50 and present satisfactory medical evidence of insurability. I understand also that my regular insurance is not affected by this declination of additional optional insurance.

Mark here if you **WANT NEITHER** regular nor optional insurance

(C)

WAIVER OF LIFE INSURANCE COVERAGE

I desire not to be insured and I waive coverage under the Federal Employees Group Life Insurance Program. I understand that I cannot cancel this waiver and obtain regular insurance until at least 1 year after the effective date of this waiver and unless at the time I apply for insurance I am under age 50 and present satisfactory medical evidence of insurability. I understand also that I cannot now or later have the \$10,000 additional optional insurance unless I have the regular insurance.

4 SIGN AND DATE. IF YOU MARKED BOX "A" OR "C", COMPLETE THE "STATISTICAL STUB." THEN RETURN THE ENTIRE FORM TO YOUR EMPLOYING OFFICE.

SIGNATURE

DATE

FOR EMPLOYING OFFICE USE ONLY

(Official receiving date stamp)

COPIES

Duplicate copy for Agency Use

See back of this form for back of original

RECEIVED

DATE

DISPATCH

CLASSIFICATION

SECRET

PROCESSING ACTION

TO Chief, WH Division

XX

MARKED FOR INDEXING

INFO.

NO INDEXING REQUIRED

FROM Chief of Station, Mexico City

ONLY QUALIFIED DESK
CAN JUDGE INDEXING

SUBJECT ADMINISTRATIVE/PERSONNEL
Transmittal of Forms SF 176-T.

MICROFILM

ACTION REQUIRED - REFERENCES

ACTION REQUIRED: Process Forms

REFERENCE: FN 20-86, dated 2 February 1968

Forwarded herewith are the forms for the below listed

personnel:

[Redacted Name]

[Redacted Name]

Jeremy K. BENADUM

*TOTB/CB
3/18/68*

[Redacted Name]

[Redacted Name]

[Redacted Name]

FOR WILLARD C. CURTIS

ATTACHMENTS:

Forms SF 176-T (HEREWITH)

DISTRIBUTION:

13 - Chief, WH Division w/atts (5)

SECRET
EXCLUDED FROM AUTOMATIC
DOWNGRADING AND
DECLASSIFICATION

CLASSIFICATION TO

DISPATCH SYMBOL AND NUMBER
HMMT-8787

DATE
20 February 1968

CLASSIFICATION

SECRET

DISPATCH NUMBER

SECRET

Chief of Division

Chief of Station, Mexico City

Admin/Personnel - Fitness Reports for Jeremy K. BENADUM, [redacted]

ACTION REQUIRED: Information Only.

REFERENCE : MEMS-5749, dated 11 January 1968.

1. Agent Evaluation Reports have been forwarded for the subject personnel as follows:

NAME	DISPATCH NUMBER	DATE
Jeremy K. BENADUM	HMSA-32877	28 August 1967
[redacted]	HMSA-8236	3 October 1967
[redacted]	HMSA-31970	10 May 1967

2. Unless advised to the contrary the Station will forward future Agent Evaluation Reports for [redacted] and BENADUM to reach Headquarters in September of each year and for [redacted] to reach Headquarters in May of each year.

[redacted signature box]
TOMMY WILLARD C. CURTIS

Received & Filed 12 Jan 1968

Distribution:
3 - Chief, WID

SECRET

17 January 1968

SECRET

CONFIDENTIAL

U. S. GOVERNMENT PRINTING OFFICE: 1960 O-282223

1. Agency and organizational description DDP/WH					2. Payroll period		3. Shift No.		4. Slip No.			
5. Employee's name (and social security account number when appropriate) REPAIRS, JEREMY K. (P) CARRIER ASSIST					6. Grade and salary \$20,856							
PAYROLL CHANGE DATA												
	BASE PAY	OVERTIME		GROSS PAY	DC.	FEDERAL TAX	BOND	F. I. C. A.	STATE TAX	GROUP LIFE INS.	HEALTH BENEFITS	NPT PAY
7. Previous normal												
8. New normal												
9. Pay this period												
10. Remarks I CERTIFY THAT THE WORK OF THE ABOVE NAMED EMPLOYEE IS OF AN ACCEPTABLE LEVEL OF COMPETENCE.								11. Appropriation		12. Prepared by jlw 10 Jan 68		
<input checked="" type="checkbox"/> Periodic step increase <input type="checkbox"/> Pay adjustment <input type="checkbox"/> Other adjustment												
14. Effective date 21 Apr 68	15. Date last regular invoice 24 Apr 68	16. Old salary rate \$20,856	17. New salary rate \$21,469	18. Performance rating is satisfactory or better.								
19. LWOP data (fill in appropriate spaces covering LWOP during following period): <input checked="" type="checkbox"/> No excess LWOP. Total excess LWOP.								(Check applicable box in case of excess LWOP) <input type="checkbox"/> In pay status at end of waiting period <input type="checkbox"/> In LWOP status at end of waiting period.				
STANDARD FORM NO. 11264 GSA GEN. REG. NO. 27				PAYROLL CHANGE SLIP — PERSONNEL COPY								

Letter of Intent, Mexico City

[Redacted]

Action required: As noted

[Redacted]

STATUS: ACTION:

[Redacted]

[Redacted]

Distribution:

- 2 - Col, Mexico City

1.00 - 1749

1.00 - 1749

Distribution:

- 1 - HQ/Contracts
- 1 - HQ/Rep.
- 1 - HQ/1

HQ/Contracts/AM-11118: ltr (4 January 1964)

1100

C/01/1

DISPATCH

SECRET

TO: Chief, WH Division

FROM: Chief of Station, Mexico City

SUBJECT: Admin/Personnel - Current Residence and Dependency Reports

ACTION REQUIRED: Information Only

Forwarded under separate cover are the current residence and dependency reports for Jeremy K. BENADUM, [redacted] and [redacted]

[redacted]
WILLIAM C. CURTIS

Attachments:
As Stated Above, usc

Distribution:
3 - Chief, WH Division, w/att

CLASSIFICATION TO	DISPATCH SYMBOL AND NUMBER HMMT - 8551	DATE 21 December 1967
	CLASSIFICATION SECRET	REF FILE NUMBER

CONFIDENTIAL
(When Filled In)

Complete in duplicate. The data recorded on this form is essential in determining travel expenses allowable in connection with leave of government expense, overseas duty, return to residence upon separation, and for providing current residence and dependency information required in the event of an employee emergency. The original of this form will be filed in the employee's official personnel folder.

NAME OF EMPLOYEE (Last)	(First)	(Middle)	SOCIAL SECURITY NUMBER
-------------------------	---------	----------	------------------------

RESIDENCE DATA	
PLACE OF RESIDENCE WHEN INITIALLY EMPLOYED BY AGENCY México, D.F.	LAST PLACE OF RESIDENCE IN CONFIDENTIAL U.S. (If appointed abroad) San Francisco, California
PLACE IN CONFIDENTIAL U.S. DESIGNATED AS PERMANENT RESIDENCE San Francisco, California	HOME LEAVE RESIDENCE San Francisco, California

MARITAL STATUS (Check one)			
<input type="checkbox"/> SINGLE	<input checked="" type="checkbox"/> MARRIED	<input type="checkbox"/> SEPARATED	<input type="checkbox"/> DIVORCED
IF MARRIED, PLACE OF MARRIAGE San Francisco, California			DATE OF MARRIAGE 9-VII-45
IF DIVORCED, PLACE OF DIVORCE DECREE			DATE OF DECREE
IF WIDOWED, PLACE SPOUSE DIED			DATE SPOUSE DIED
IF PREVIOUSLY MARRIED, INDICATE NAME(S) OF SPOUSE, REASON(S) FOR TERMINATION, AND DATE(S)			

MEMBERS OF FAMILY			
NAME OF SPOUSE	ADDRESS (No., Street, City, Zone, State)	TELEPHONE NO.	
[Redacted]	Calle Ojo de Agua 43, "La Hda."	65-24-36	
NAME OF CHILDREN	ADDRESS	SEX	DATE OF BIRTH
[Redacted]	" " " " " " " "	P	[Redacted]
[Redacted]	" " " " " " " "	P	[Redacted]
[Redacted]	" " " " " " " "	M	[Redacted]
(Cont.)			
NAME OF YOUR FATHER (or male guardian)	ADDRESS	TELEPHONE NO.	
[Redacted] (Deceased)	[Redacted]	[Redacted]	
NAME OF YOUR MOTHER (or female guardian)	ADDRESS	TELEPHONE NO. (Area)	
Mrs. [Redacted]	Santa Barbara, Calif. 1320 Mission Ridge Rd., WKK.	965-6146 8051	
WHAT IF NO MEMBER OF YOUR FAMILY IF ANY, HAS BEEN TOLD OF YOUR AFFILIATION WITH THE ORGANIZATION IF CONTACT IS REQUIRED IN AN EMERGENCY.			

PERSON TO BE NOTIFIED IN CASE OF EMERGENCY	
NAME (Mr., Mrs., Miss) (Last-First-Middle)	RELATIONSHIP
[Redacted]	Wife
HOME	HOME TELEPHONE NUMBER
[Redacted]	65-24-36
BUSINESS ADDRESS (No., Street, City, Zone, State) AND NAME OF EMPLOYER, IF APPLICABLE	BUSINESS TELEPHONE & EXTENSION
N/A	

IS THE INDIVIDUAL NAMED ABOVE WITHIN OF YOUR AGENCY AFFILIATION? (If "No" give name and address of organization (It can be believed you work for.)	YES	<input checked="" type="checkbox"/>
	NO	<input type="checkbox"/>
IS THIS INDIVIDUAL AUTHORIZED TO MAKE DECISIONS ON YOUR BEHALF IN THE EVENT YOU ARE INCAPABLE? (If "Yes" give name and address of person, if any, who can make such decisions in case of emergency.)	YES	<input checked="" type="checkbox"/>
	NO	<input type="checkbox"/>
DOES THIS INDIVIDUAL KNOW THAT HE HAS BEEN DESIGNATED AS YOUR EMERGENCY ADDRESSEE? (If answer is "No" explain why in item 5.)	YES	<input checked="" type="checkbox"/>
	NO	<input type="checkbox"/>

The persons named in item 3 above may also be notified in case of emergency. IF SUCH NOTIFICATION IS NOT DESIRABLE BECAUSE OF HEALTH OR OTHER REASONS, PLEASE SO STATE IN ITEM 6 ON THE REVERSE SIDE OF THIS FORM.

CONTINUED ON REVERSE SIDE

CURRENT RESIDENCE AND DEPENDENCY REPORT

4. VOLUNTARY LEADINGS

Experience in the handling of emergency situations has shown that the absence of written personal data often delays and complicates the settlement of estate or other matters. The information requested in this section may prove very useful to your family in the event of your disability or death and will be disclosed only when circumstances warrant.

5. AT THE HOME AND ADDRESS OF ANY BANKING INSTITUTIONS WITH WHICH YOU HAVE ACCOUNTS AND THE NAME(S) IN WHICH THE ACCOUNTS ARE MAINTAINED:

Wells Fargo Bank, 464 California Street, San Francisco, Calif.
 (Account in writer's name)

6. ARE YOU A MEMBER OF THE ~~LOCAL~~ CREDIT UNION? YES NO

7. IF YES, DO YOU HAVE A JOINT ACCOUNT? YES NO

8. HAVE YOU COMPLETED A LAST WILL AND TESTAMENT? YES NO. (If "Yes" where is document located?)

9. HAVE YOU PRE-PLANNED OR ARRANGED GUARDIANSHIP OF YOUR CHILDREN IN CASE OF COMMON DISASTER TO BOTH PARENTS? YES NO. (If "Yes" give name(s) and address)

Mr. and Mrs.

10. HAVE YOU EXECUTED A POWER OF ATTORNEY? YES NO. (If "Yes" who possess the power of attorney?)

11. ADDITIONAL DATA AND/OR CONTINUATION OF PRECEDING ITEMS

3. (Cont.) Children:

Address:

Sex:

DOB

(Same as indicated for others)

F.
F.

Univ. of Santa Clara, Santa Clara, Calif. (during school yr.) F.

SIGNED AT
Mexico, D.F.

DATE
18 Dec., 1967

SIGNATURE
Jose F. Mauro

CONFIDENTIAL

SECRET

Chief of Station, Mexico City

X

C/MI

BENADU, Jeremy K., [redacted]

Action Required: As noted

The attached Form 61 should be completed in duplicate and [redacted] by BENADU, [redacted] and forwarded to Hqs. It is important that the information contained on the form be filed in Hqs, therefore, rapid response would be appreciated.

[redacted]

Attachment:

As stated (h/w)

Distribution:

2 - C/S, Mexico City

1000 - 5668

SECRET

Distribution:

1 - MI/Rep
1 - MI/Contracts
1 - MI/1

MI/Contracts, [redacted]: 1sr (14 Nov 67)

4460

C/MI/1

SECRET

Date 19 October 1967

Memorandum For: Chief, Insurance Branch/ESD/CP

This is to advise you that Jeremy K. Benadum has been employed under an Agency personal services contract effective 25 September 1967. The Contract authorizes participation in Civil Service Retirement, FEGLI and Federal Health Insurance.

Subject's contract is the administrative responsibility of DDP/WH.

[Redacted Signature]

Chief
Contract Personnel Division

SECRET

Group 1
Excluded from automatic down-
grading and declassification

9 October 1967

MEMORANDUM FOR: Insurance Branch
FROM : C/WH/CONTRACTS
SUBJECT : Applications for Health Insurance

The Employee Payroll numbers for the attached are as follows:

[REDACTED]	-----131890
JEREMY K. BENADUM	-----058895
[REDACTED]	-----015249

Re the above HMT-8282 dated 18 Sept. 1967, which transmitted the attached applications, states: "All of the above Personnel have requested that their Dependents, as listed under their current contract employee type Health Insurance, be covered under the new Health Insurance for which they are applying."

Wm. Renchan

DDP/WH/Contracts/WSRenchan: jt (9 October 1967)

0 & 1 - Addressee
2 - WH/Contracts

S-E-C-R-E-T

MR. JEROME E. ENRADEN

Dear Mr. ENRADEN:

The United States Government, as represented by the Contracting Officer of this organization, hereby contracts with you, as a ~~contract~~ Career Agent ~~employee~~ under the terms and conditions set forth below:

1. How Benefits. By virtue of your employment relationship under this agreement you are:

(a) Covered under the Civil Service Retirement Act in conformance with rules and regulations applicable to appointed employees of this organization. From the basic compensation paid you hereunder there shall be deducted the appropriate rate percentage (presently 6-1/2%) for deposit and eventual crediting to the Civil Service Retirement Fund. Social Security deductions required by virtue of your cover activities will not be reimbursed you by this organization.

(b) Covered under the Federal Employees Group Life Insurance Act in conformance with rules and regulations applicable to appointed employees of this organization unless you execute a written waiver of such coverage. The Government is presently authorized to bear a portion of the premium cost; you will bear the remainder.

(c) Eligible for coverage under the Federal Employees Health Benefits Act in conformance with rules and regulations applicable to appointed employees of this organization. The Government is presently authorized to bear a portion of the premium cost, you will bear the remainder. Because of your eligibility under this Act (whether or not you choose to enroll), your coverage under the contract employee health program shall cease thirty-one (31) days after the effective date of this agreement.

2. Your previous contract with the United States Government, effective in October 1964, is herein terminated by mutual consent of the parties thereto.

3. All provisions of said previous contract not in conflict with this agreement are incorporated by reference into and made a part of this agreement.

S-E-C-R-E-T

S-E-C-R-E-T

4. This agreement is effective as of 25 November 1957 and shall continue thereafter for an indefinite period unless sooner terminated as set forth in your previous contract. If this agreement becomes effective during an overseas assignment nothing contained herein shall be construed as extending that assignment beyond its originally contemplated duration or invalidating your entitlement to return travel expenses (if applicable) upon completion of that assignment.

UNITED STATES GOVERNMENT

BY:

Contracting Officer

ACCEPTED:

James K. ...
~~...~~

WITNESSES:

APPROVED:

REVIEWED:

/s/

Special Contracting Officer

S-E-C-R-E-T

DISPATCH

CLASSIFICATION
SECRET

FORM AND ACTION

TO: Chief, WH Division

FROM: Chief of Station, Mexico City *[Handwritten signature]*

SUBJECT: Admin/Personnel - New Benefits for Certain Contract Employees

ACTION REQUIRED: Information Only

REFERENCE : Book Dispatch Number 0144, Dated 24 August 1965

1. Furnished herewith are amended contracts and applications for health insurance, except for [redacted], for personnel as follows:

fwd 6 Oct 67

Jeremy K. BEHADUM

[redacted]

2. [redacted] application for health insurance was forwarded in letter 0219, dated 22 August 1967.

3. All of the above personnel have requested that their dependents, as listed under their current contract employee type health insurance, be covered under the new health insurance for which they are applying.

4. [redacted] has elected not to accept the new benefits.

5. [redacted] will discuss the new benefits while she is at Headquarters.

6. Because of the indefinite future of [redacted] action is deferred to Headquarters.

CA [redacted] action 5 Oct 67

[redacted]
[redacted]

100/WILLARD C. CURTIS

Attachment:
As Stated Above, h/w

Distributions:
3 - Chief, WHD, w/att

SB accepted action on [redacted]

Per telegram w/ [redacted] on 5 Oct 67 JW

CROSS REFERENCE TO

DISPATCH SYMBOL AND NUMBER

DATE

HRMT - 8292

18 September 1967

CLASSIFICATION

DISPATCH NUMBER

SECRET

NO
 CLASSIFIED MESSAGE *A* TOTAL COPIES: *19*

FILE NO. _____

FILE RID AFF. TO BRANCH

DESTROY SIG. _____

PERSON/UNIT NOTIFIED _____

REPRODUCTION PROHIBITED

1	3
2	6
3	7
4	8

ACTION *D. [Signature]* RID COPY ISSUED CLASSIFIED TROOP

UNIT _____ TIME _____ BY _____

INFO FILE, *VR*, CCS-3, C3Ps, *Op 2*, *DF-2*

SECRET 151842Z CITE MEXICO CITY 9833

DIRECTOR

151842Z 39532

REF JUNIT-7199

JEREMY K. SENADUM AND FAMILY DEPARTING STATIST BY AIR ON HOME LEAVE 16 NOVEMBER 1966.

SECRET

BT

SECRET

F. Madeline Munroe

DISPATCH

CLASSIFICATION
SECRET

PROCESSING ACTION

TO
Chief of Station, Mexico City

FROM
Chief, WFOAMS

SUBJECT
AIR/JECINT - Jeremy K. BEZADON (p) - Tax Handling

MARKED FOR INDEXING

NO INDEXING REQUIRED

ONLY QUALIFIED DESK CAN JUDGE INDEXING

MICROFILM

ACTION REQUIRED - REFERENCES

The WFOACT Tax Committee has approved a flat rate assessment of BEZADON's Federal tax obligation, beginning with tax year 1965. Attached is the letter of tax instruction which he should review. The original must be signed and returned to Headquarters.



Distribution:

- Orig. & 1 - COG (v/att)
- 2 - ISI/Pers

CROSS REFERENCE TO

DISPATCH SYMBOL AND NUMBER

DATE

522-1971

19 September 1965

CLASSIFICATION

NSA FILE NUMBER

SECRET

19 September 1966

MEMORANDUM FOR: Jersey K. BENADUM (p)

SUBJECT: Federal Tax Obligation - Letter of Instruction

1. Based on the tax briefing held on 16 February 1966 by a representative of the Organization's Tax Committee, the Committee approved a flat rate assessment of your [redacted] Federal tax obligation.

[redacted] your future year tax position and is based on an average of your annual Organizational income of \$19,305.60 developed from a two-year projection of your earnings, beginning with tax year 1966.

2. Effective 30 December 1964, the beginning of tax year 1965, the Organization has applied a tax percentage of thirty (30.0) per cent to the gross taxable compensation paid by the Organization in 1965. Effective 19 December 1965, the beginning of tax year 1966, this percentage will be decreased to twenty-three and four-tenths (23.4) per cent.

3. The application of the percentage assessment to tax year 1965 results in a tax liability of \$5,490.96 (30% of \$18,303.20). After applying the tax withheld of \$2,562.49, an additional payment of \$2,928.47 is required. However, future changes in your income or tax status may justify a future revision of the assessment rate. In this event, this agreement would be amended accordingly.

4. The Tax Committee has granted you a basic \$250.00 tax credit in computing the percentage rate. This credit is granted to give reasonable assurance that you will not pay higher tax than you would under ordinary reporting procedures. The computations of these percentage rates are attached.

5. The retroactive satisfaction of this assessment from 19 December 1965 will be made by attaching the Federal tax withholdings available in your pay account. You will be advised as to the effect of this payroll account adjustment. You must file a tax return directly with Internal Revenue consistent with your overt tax status and provide the Tax Committee with a certified true copy. It is extremely important for you to exercise care and accuracy in preparing this return. Provided below are specific criteria to assist you:

You will continue to file a tax return directly with Internal Revenue, reporting other income (interest, dividends, rental, etc.) and computing tax thereon. [redacted]

[Redacted]

[Redacted]

[Redacted]

7. Please acknowledge the original of this letter and return to Headquarters, attention: Covert Tax Committee.

8. The Tax Committee appreciates your cooperation in establishing this systemized method of satisfying your Federal tax liability on Organizational income.

[Redacted]

Acknowledged:

Date _____

DISPATCH

CLASSIFICATION

SECRET

PROCESSING ACTION

TO Chief, VM Division

INFO

FROM Chief of Station, Mexico City

SUBJECT Performance Report -- Jeremy K. BENADUM, Career Agent

MARKED FOR INDEXING

XX

NO INDEXING REQUIRED

ONLY QUALIFIED DESK
CAN JUDGE INDEXING

MICROFILM

ACTION REQUIRED REFERENCES

1. Jeremy K. BENADUM is a GS-15 Career Agent who has been employed by the Station in Mexico [redacted]

2. BENADUM is responsible for management of an outside operational activity employing six Mexican paid agents and twenty-six unpaid agents, all with access [redacted]

[redacted] The current budget for this project is \$61,000. US per year. The project (LITEMPO) provides the Station with both [redacted]

[redacted] It also provides for a semi-official liaison arrangement between the Station and [redacted]

3. BENADUM for the past year has also directed the activities of a Station surveillance asset of six men. This team was placed under BENADUM when its existence became known [redacted]

[redacted] Two members of the team were arrested [redacted] and BENADUM assisted in obtaining their release.

4. Prior to employment by the Station, BENADUM had been employed for twenty years by LNERGO. He has fluent Spanish; has [redacted] devised independently; has extensive experience in investigative and training activities. He has performed in a most valuable manner in the management of the above described projects and in the development of close working relationships with [redacted]

[redacted] Through these contacts, established over the years, COS Mexico and high-ranking Headquarters officials are able to meet [redacted]

Willard C. CURTIS

Distribution:
3 - BH

FORM 2-70 (REV. 1-67)

4 August 1968

SECRET

201-707777

SECRET

DATE: _____

CTC No. _____

MEMORANDUM FOR: Director of Finance

ATTENTION: Chief, Compensation and Tax Division

VIA: Chief, Contract Personnel Division

SUBJECT: Tax Assessment for _____

1. A flat rate covert tax assessment of this individual's gross, taxable Agency entitlements has been approved by the Covert Tax Committee as indicated below. An acknowledged letter of tax instruction is will be forwarded.

Tax Assessment Rate	Effective Date
Twenty-three and four-tenths (23.4%)	

2. Other payroll factors pertinent to this Covert Tax Committee tax assessment action are as follows:

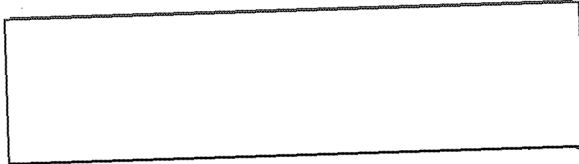

A report will be submitted to the Covert Tax Committee.

/s/ _____

 Director, Chief, CTC

 Secretary, Covert Tax Committee

Mr. Jeremy K. Benadum

Mr. Benadum

Reference is made to the contract entered into with the
United States Government, as amended by the Contracting
Officer

Effective **29 July 1956**

said contract is amended by deleting all reference to income taxes therefrom, and by adding thereto the following paragraph:

15 The contractor shall pay to the Government into
must satisfy your Federal income tax liability. Income tax to
you made a part of **three (3)** percent of the net income.
may be paid you by or for the contractor in the case of
cover operational and administrative expenses of the contractor
of this organization is authorized to make such deductions
and establish procedures which will result in a full and complete
of your Federal income tax liability. It is
apudically understood and agreed that all such conditions and
procedures, whether oral or written, constitute an integral part of
this contract and are hereby incorporated herein by reference.

All other terms and conditions of said contract remain in full force and effect.

Handwritten signature

CONFIDENTIAL

U.S. GOVERNMENT PRINTING OFFICE: 1960 O-390-13

1. Agency and organizational designation DDP/WI		2. Payroll period		3. Block No.		4. Slip No.					
5. Employee's name (and social security account number when appropriate) BEHADUN, Jeremy K. (P) CAJONIA AGENT				6. Grade and salary \$18,825							
PAYROLL CHANGE DATA											
	BASE PAY	OVERTIME	LOCAL TAX	RET.	FEDERAL TAX	BOND	F. I. C. A.	STATE TAX	GROUP LIFE INS.	HEALTH BENEFITS	NET PAY
7. Previous normal											
8. New normal											
9. Pay this period											
10. Remarks I CERTIFY THAT THE WORK OF THE ABOVE NAMED EMPLOYEE IS OF AN ACCEPTABLE LEVEL OF COMPETENCE.					11. Appropriation		12. Prepared by JLV 7 Jan 66		13. Audited by J		
<input checked="" type="checkbox"/> Periodic step-increase <input type="checkbox"/> Pay adjustment <input type="checkbox"/> Other step-increase											
14. Effective date 21 JAN 66	15. Date last regular pay increase 26 DEC 65	16. Old salary rate \$18,825	17. New salary rate \$19,415	18. Performance rating is satisfactory or better.							
19. LWOP data (fill in appropriate spaces covering 1 year during following periods): <input checked="" type="checkbox"/> No excess LWOP. Total excess LWOP.											
										Signature or other authentication <input type="checkbox"/> In pay status at end of waiting period. <input type="checkbox"/> In LWOP status at end of waiting period.	
										Initials of Clerk	

STANDARD FORM NO. 1126B
GSA GEN. REG. NO. 27

CONFIDENTIAL PAYROLL CHANGE SLIP — PERSONNEL COPY

DISPATCH

MARKED FOR INDEXING
 NO INDEXING REQUIRED
 FILED UNDER OTHER
 CAN JUDGE INDEXING
 MICROFILM

TO: SAC, Division
 FROM: Chief of Station, Mexico City
 SUBJECT: LEGISLATIVE/Contract
 Legislative Pay Increase for Contract Personnel

ACTION REQUIRED - REFERENCES

- ADMINISTRATIVE:** Amend contracts to provide for the legislative pay increase for the below listed contract personnel.
- REFERENCE:** Para 2a of SW 20-56, dated 4 November 1965

Detailed below are the names of contract employees and career agents qualifying under the reference for the subject legislative pay increase:

[Redacted]

[Redacted]

[Redacted]

Distribution:
 3 - MID

*File 14
 Find CPD*

[Handwritten initials]

DISPATCH NUMBER: 17714-252
 DATE: 18 November 1965

MESSAGE FORM 13

1	2	3	4	5	6	7	8

ORIG. [] 1364
 UNIT: WH/1
 EXT: 4507
 DATE: 16 December 1960

INDEX
 NO INDEX
 FILE IN CS FILE NO. 201-287227

SECRET

TO: MEXICO CITY

FROM: DIRECTOR

COM: WH 8

INFO C/OA, OP SER, OT, VR, FILE

ROUTINE 23 00z

SIG GEN

TO: MEXI

REF: HDSW-15153

CITE DIR: 71512

INFO

No Bill

WOULD APPRECIATE CABLE REPLY REF ON BENADUM TRAINING AS SOON AS POSSIBLE.

END OF MESSAGE

5
4
3
2
1

JH
 DESMOND FITZGERALD
 C/WED

[]
 C/WH/L

RELEASING OFFICER

COORDINATING OFFICERS

SECRET

GROUP 1 Excluded from automatic downgrading and declassification

AUTHENTICATING OFFICER

REPRODUCTION BY OTHER THAN THE ISSUING OFFICE IS PROHIBITED.

Copy

SECRET

Chief of Station, Mexico City

XX

Chief, WID

Training for Jeremy K. BENADUM

PRIORITY

REFERENCE: HMMA 24477

Action Required: Cable Reply to paragraph 3

1. Reference is made to paragraph 3 of HSNW 12349, 28 February 1964, which suggested that KUZARK training for BENADUM might be beneficial, and to page 8 paragraph 3 of HMMA 24477, the LITEMPO Project Renewal Request, which also indicated that a two-week intensive field training course would be valuable for BENADUM.

2. Headquarters has discussed this possibility with KUROAR, and they are prepared to send a trainer to Mexico City for two weeks beginning 18 January 1965. Headquarters has suggested that the trainer be prepared to cover positive intelligence and operational reporting, requirements, and elicitation from his contacts and agents.

3. Please cable whether the dates 18 - 29 January are convenient and whether the subjects to be covered are those envisioned by the Station.

4. Headquarters added to the Project Renewal request \$748.95 to cover the per diem and travel of the TDY trainer.

Distribution:

Orig & 1 - COS, Mexico City

HMMA 13153

30 November 1964

SECRET

30-2872-7
50-6-9/1

DISPATCH

CLASSIFICATION

DATE

TO: STATE

FROM: [Redacted] Division

Office of Station, Mexico City

MARKED FOR INDEXING

NO INDEXING REQUIRED

ONLY IN THESE CASES CAN AN INDEXING

MICROFILM

[Redacted]

REFERENCES

Jersey K. BORDERS

REFERENCE: DDCN DISPATCH 4659, 16 November 1964

Enclosed is information requested in reference as prepared by BORDERS.
 Your separate [Redacted] is corresponding information as required.
 Orders on the pertinent forms correspond to the numbered items listed in
 attachment to reference.

WILLARD C. CURTIS

Attachment:
 As stated (h/w, USC)

Distribution:
 2 - KNOX, w/atts
 1 - WID, w/o atts

REFERENCES TO	DISPATCH SYMBOL AND NUMBER	DATE
	1964-5281	11 March 1965
	CLASSIFICATION	FILE NUMBER
	SECRET	

DISPATCH

CLASSIFICATION
SECRET

PROCESSING ACTION

TO
Chief of Station, Mexico City

FROM
Chief, Western Hemisphere Division

SUBJECT
Career Agents - Legislative Pay Adjustments

SEARCHED FOR KEYWORDS
INDEXED
SERIALIZED
FILED

ACTION REQUIRED: INFORMATION

1. During [redacted] recent TDY at Headquarters, he informed [redacted] that the last Legislative Pay Adjustment had not been granted to the following named Career Agents at the Station. He was advised that follow-up action would be taken and information forwarded to the Station.

✓
Jeremy K. BENADUM
[redacted]

2. The contract for each of the above named individuals except [redacted] contains the provision he shall receive any Legislative Pay Adjustment adopted by KUBARK. As the provision is a contractual item, the individual will automatically receive the increase without any requirement for a specific request or justification. Although not on the above list, the same information also pertains to [redacted]. [redacted], a Contract Employee, was authorized the increase (Phase II) by an amendment effective [redacted] as his contract does not provide for automatic entitlement.

3. The Payroll Branch advised that except for BENADUM, the increase was reflected in the pay period ending 18 January 1964 as indicated in the earnings statement provided each individual. HOSIS-3534, 28 May, was sent to the Station by Payroll to increase BENADUM's field allotment in accordance with the pay adjustment.

[redacted]

CLASSIFICATION: SECRET

DISPATCH SYMBOL AND NUMBER: HOSIS-3566

DATE: 12 June 1964

CLASSIFICATION: SECRET

DISPATCH SYMBOL AND NUMBER: HOSIS-3566

SECRET

MEMORANDUM FOR: DDP/WH Personnel Officer
SUBJECT: Within Grade Increase for Career Agents

1. The following Career Agents assigned to your office will become eligible for a Within Grade Increase during the month of APRIL 1964.

<u>Name (P)</u>	<u>Old Salary Rate</u>	<u>New Salary Rate</u>	<u>Date Due</u>
Benadum, Jeremy K.	\$16,695	\$17,210	26 Apr 1964

*Final - April 3
7 Feb 64
Final - 10 Feb 64
O/P - 5E69*

2. Please return the signed Within Grade Increase form to
Room 5 E 69.

SECRET

CONFIDENTIAL

U. S. GOVERNMENT PRINTING OFFICE: 1962-58848

1. Agency and organizational designation DDP/WH				2. Payroll period		3. Slip No.		4. Slip No.					
5. Employee's name (and social security account number when appropriate) BENADUM, Jeremy K. (P) CAREER AGENT						6. Grade and salary \$16,695							
PAYROLL CHANGE DATA													
	BASE PAY	OVERTIME		GROSS PAY	RET.	FEDERAL TAX	BOND	F. I. C. A.	STATE TAX	GROUP LIFE INS.	HEALTH BENEFITS		NET PAY
7. Previous normal													
8. New normal													
9. Pay this period													
10. Remarks: I CERTIFY THAT THE WORK OF THE ABOVE NAMED EMPLOYEE IS OF AN ACCEPTABLE LEVEL OF COMPETENCE.						11. Appropriation(s)		12. Prepared by Jlv 15 Jan 64		13. Audited by			
<input checked="" type="checkbox"/> Periodic step-increase <input type="checkbox"/> Pay adjustment <input type="checkbox"/> Other step-increase										(Signature or other authentication)			
14. Effective date 26 Apr 64	15. Date last equivalent increase 28 Apr 63	16. Old salary rate \$16,695	17. New salary rate \$17,210	18. Performance rating is satisfactory or better									
19. LWOP data (fill in appropriate spaces covering LWOP during following period(s): <input type="checkbox"/> No excess LWOP. Total excess LWOP.										<input type="checkbox"/> (Check applicable box in case of excess LWOP) <input type="checkbox"/> In pay status at end of waiting period. <input type="checkbox"/> In LWOP-status at end of waiting period.			
STANDARD FORM NO. 1126d GSAO 5000 1126-508										CONFIDENTIAL - PAYROLL CHANGE SLIP - PERSONNEL COPY			

DISPATCH

CLASSIFICATION
SECRET

PROCESSING ACTION

MARKED FOR INDEXING

NO INDEXING REQUIRED

ONLY QUALIFIED DESA

CAN ASSESS INDEXING

MICROFILM

TO

Chief, WH Division

INFO

FROM

Chief of Station, Mexico City

SUBJECT

Compensation Schedule II Increase - Jeremy N. BENDON, Emp # 058005

ACTION REQUIRED - REFERENCES

Reference: EN 20-29, 4 October 1963

It is requested that Subject's career merit contract be amended to provide for the compensation increase provided by Compensation Schedule II of the Federal Salary Reform Act of 1962.

Willard C. Curtis
Willard C. Curtis

Distribution
13-17

CROSS REFERENCE TO

DISPATCH SYMBOL AND NUMBER

DATE

13-17

058005

15 October 1963

CLASSIFICATION

FORM 1-62 (REV. 1-55)

L.H. 13

MEMORANDUM TO : DDP/WH Personnel Officer

SUBJECT : Within Grade Increase for Career Agents

1. The following Career Agents assigned to your office will become eligible for a Within Grade Increase during the month of **APRIL 1963**

<u>Name (F)</u>	<u>Old Salary Rate</u>	<u>New Salary Rate</u>	<u>Date Due</u>
<i>Benadam, Jeremy K.</i>	\$15,045	\$15,525	28 Apr 63

Benadam

*fund'd Office of Pers.
15558
27 Feb 63
E.H.*

2. Please refer to the... Room 3 B 14.

DISPATCH

CLASSIFICATION
SECRET

PROCESSING

TO	FROM	SUBJECT	INFO	ACTION	ACCOM PLISHED
			Chief, Finance Division	Chief, Services & Benefits Division/OP Chief, WH Division	Chief of Station, Mexico City
				INDEXED	
				RECLASSIFIED	
				NO INDEXING	
				ABSTRACT	
				NO INDEX	

ACTION REQUIRED: REFERENCES

Forwarded herewith is Station T/A # 00125, representing
 Jeremy K. BENADUN's payment of \$72.00 covering 6 months' premiums
 on his term life insurance.

Willard C. GIBBIS

Attachment - 1 T/A, as noted

DISTRIBUTION:

- 2-Finance Division w/attachment
- 1-WH Division w/o attachment
- 2-Files
- 1-Benefits & Services Div/OP w/o att

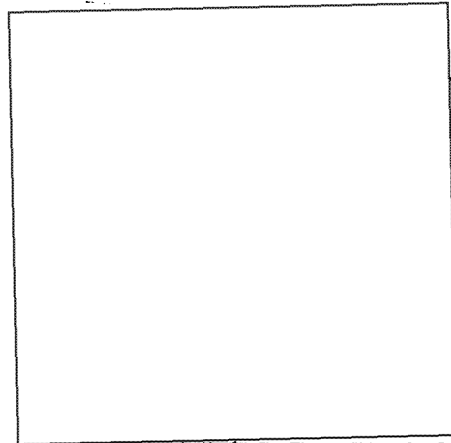

DATE TYPED: 31 Jan 1962 DATE DISPATCHED: 31 Dec 1962
(DISPATCH SYMBOLS AND NUMBER)

FORM-T-3314
MANUFACTURING NUMBER

GROUP 1
 Excluded from automatic
 downgrading and
 declassification

CLASSIFICATION
SECRET

SECRET

TRAVEL ORDER

TOY
 FOR
 INVITATIONAL

OFFICE TRAVEL ORDER NO.
WH 317-63

NAME **Jeremy F. BENARD (P) Career Agent**

SERVICE TRAVEL ORDER NO.

OFFICIAL STATION
Mexico City, Mexico

OFFICE PHONE

GRADE
GS-13

YOU ARE AUTHORIZED TO TRAVEL AND INCUR NECESSARY EXPENSES IN ACCORDANCE WITH REGULATIONS. THIS TRAVEL ON CHARGE OF OFFICIAL STATION, IF SO DESIGNATED, IS MADE FOR OFFICIAL PURPOSES AND NOT FOR YOUR PERSONAL CONVENIENCE.

ITINERARY, MODE OF TRAVEL AND PURPOSE

Mexico City to San Francisco for approx. 90 days home leave and return to Mexico City.

Purpose: Home Leave

Mode : Air, Common Carrier

TRAVEL DURATION		PER DIEM ALLOWANCE		AUTOMOBILE ALLOWANCE	
BEGIN	END	DOMESTIC	FOREIGN	CENTS PER MI NOT TO EXCEED COST BY COMMON CARRIER	CENTS PER MI AS MORE ADVANTAGEOUS TO GOVT.
0 Dec.	1 Mar. 63	Max.	<input checked="" type="checkbox"/> MAXIMUM	<input type="checkbox"/> OTHER (See below)	

ALLOWANCES AND SPECIAL PROVISIONS WITH REASONS

DEPENDENT TRAVEL AUTHORIZED			PROCURE TRANSPORTATION BY		ESTIMATED COST OF TRAVEL	
NAME	DATE OF BIRTH	RELATIONSHIP	TRANSPORTATION REQUIRED	CASH OR OTHER		
		Wife			\$2,000.00	
		Child	DISPOSITION OF EFFECTS AUTHORIZATION		I CERTIFY FUNDS ARE AVAILABLE OBLIGATION REFERENCE NO. 317	
		Child	SHIPMENT	UNTEMPERED STORAGE		
		Child	EXCESS BAGGAGE AUTHORIZED		CHANGE COST CENTER NO. 3135-5701-5185	
		Child	ACCOMPANIED	UNACCOMPANIED		
		Child	LBS. AND MODE	LBS. AND MODE	DATE 12/1/62	
		Child	ADVANCE OF FUNDS REQUESTED		SIGNATURE OF D & P OFFICER	
		Child	YES	ACCOUNTING DUE DATE		
		Child	NO			

OPERATION			REQUESTING OFFICIAL	
SIGNATURE	TITLE & COMPONENT	DATE	TYPED NAME AND TITLE	COMPONENT
	WH/Pers.			WH/Pers.
	Chief, WH 3			7 Dec. 62
				08/19/62
				7 Dec. 1962

SECRET

715

CLASSIFIED MESSAGE

DATE : 1 DEC 62

TOP SECRET

Handwritten: B

ROUTING	
1	
2	<i>Handwritten: [Signature]</i>
3	<i>Handwritten: [Signature]</i>

TO : DIRECTOR

FROM : MEXICO CITY

ACTION: WH 8

INFO : CCS 2, CP 2, S/C 9

DEC 1 0330Z 62

ROUTINE

Carrier Agent

IN 27561

DIR CITE MEXI 2728

1. REQUEST NO TVL ORDERS FOR HOME LEAVE TVL OF JEREMY K. BENADUM, WIFE, 2 CHILDREN FULL FARE 4 CHILDREN HALF FARE, AND 1 BABY UNDER 2 YRS.
2. TO DEPART MEXICO CITY ABOUT 6 DEC FOR SAN FRANCISCO (HOME LEAVE POINT) VIA AIR, RETURN TO MEXICO CITY AFTER HOME LEAVE.

END OF MESSAGE

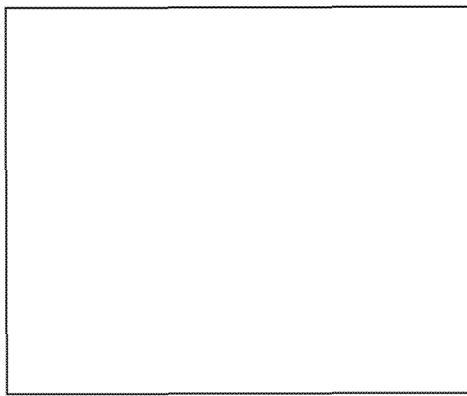
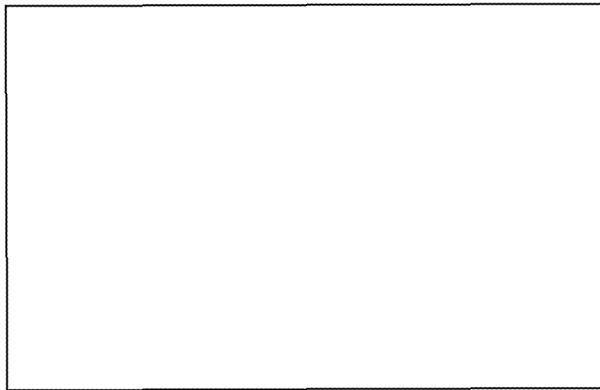

TOP SECRET

GROUP 1
EXCLUDED FROM AUTOMATIC DOWNGRADING AND DECLASSIFICATION

REPRODUCTION BY OTHER THAN THE ISSUING OFFICE IS PROHIBITED.

Copy No.

S-E-C-R-E-T

Date 20 August 1952

Career Agent Biographic Data

a. Pseudonym of agent: SENADUM Jeremy K. Staff or Division: WFO
Last First MI

b. Date and place of birth:

c. Marital status: Married

d. Relationship and years of birth of dependents:

e. Citizenship of agent: USA
(1) If naturalized, when?
(2) If naturalized, where?

g. Non-CIA education to include name and location of college, degrees, dates, and major:
Pomona College, Claremont, California, A.B. 1935, Political Science
Stanford Univ Law School, LL.B. 1939, Law
FBI Academy, August, September 1940

h. Military service: Thompson Art Training, Infantry School, Oct 1939-July 1940
(1) Country served and years:
(2) Branch of service and rank:

i. Non-CIA employment: kinds of business or profession, positions, salaries, locations, and dates:
FBI - Aug 1940-Sept 1949, GS-14, \$11,000/year when assigned.
Assistant Legal Attache, US Embassy, Lima, Peru, 1941-43
Legal Attache Same post, 1944-47
Assistant Legal Attache, Mexico City, 1948-50
Deputy to Legal Attache 1947-50

S-E-C-R-E-T

GROUP 1
Excluded from automatic
downgrading and declassification

S-E-C-R-E-T

(Career Agent Biographic Data p. 2)

j. Dates of psychological assessment, professional and language aptitude tests, if applicable:

Not applicable

k. Languages, including English, using the following terms:
Elementary, Intermediate, High, Native

<u>Language</u>	<u>Reading</u>	<u>Writing</u>	<u>Speaking</u>
Spanish	high	high	high
English	native	native	native
German	intermediate	some	intermediate
French	elementary	some	elementary

l. Agency training:

<u>Subject Covered</u>	<u>Duration of Course</u>	<u>Years Taken</u>
not applicable		

m. Alias or pseudonym used for psychological assessment, testing or training, if applicable:

not applicable

n. Security clearance number: **CGA, 21 December 1960 - 3-11409**

o. Date of last LCFLUTTER: **None**

p. Contract provisions: (Underline One)

(1) Provision for periodic step increases	<u>Yes</u>	No
(2) Provision for legislative pay increases	<u>Yes</u>	No
(3) Provision for total offset of cover income	<u>Yes</u>	No
(4) Provision for civil service retirement	<u>Yes</u>	No
(5) Any unusual provisions (please specify)		

S-E-C-R-E-T

S-E-C-R-E-T

(Career Agent Biographic Data p. 3)

q. Date of beginning of current tour: **30 October 1960**

r. Previous CIA employment:

<u>Years</u>	<u>Type of Cover</u>	<u>CIA Duties</u>	<u>Project</u>	<u>City</u>	<u>Salary</u>
--------------	----------------------	-------------------	----------------	-------------	---------------

None

S-E-C-R-E-T

Chief of Station, Mexico City

X

SEARCHED	INDEXED
SERIALIZED	FILED
AUG 6 1962	
FBI - MEXICO CITY	

Chief, WID

Term Life Insurance Premium - Jeremy K. BENADUM

For your information

Ref: 1007-2907

1. BENADUM'S application for the Term Life Insurance, together with the payment of \$72.00 for the six months' premium have been received. His life insurance is now paid up through December 1962.

2. BENADUM did authorize deductions to pay the insurance premiums, but since he is being payrolled in the field, it will be necessary for him to forward future premium payments to Headquarters.

END OF DISPATCH

Distributions:
3 - Mexico City

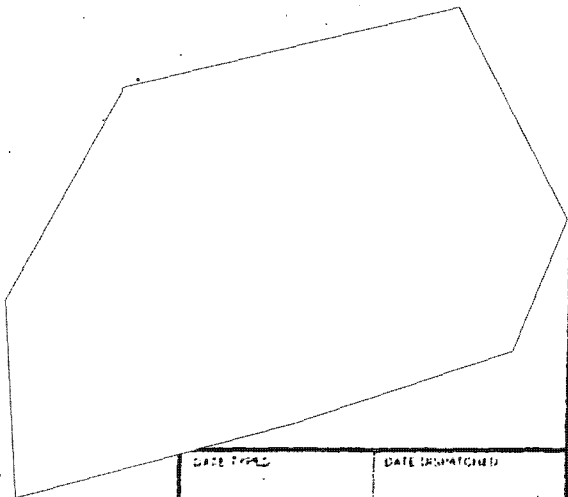

DATE TYPED	DATE DISPATCHED
6 August 1962	

DISPATCH SYMBOL AND NUMBER
100-3-235 3531

CLASSIFICATION
SECRET

Distributions:
1 - SI/Pers
1 - SI/Mailroom

CLASSIFICATION	DISPATCH SYMBOL AND NUMBER	DISPATCH NUMBER
SECRET	100-3-235 3531	5269

CLASSIFICATION	DISPATCH SYMBOL AND NUMBER	DISPATCH NUMBER
SECRET	100-3-235 3531	5269
CLASSIFICATION	DISPATCH SYMBOL AND NUMBER	DISPATCH NUMBER
SECRET	100-3-235 3531	5269

CLASSIFICATION	DISPATCH SYMBOL AND NUMBER	DISPATCH NUMBER
SECRET	100-3-235 3531	5269

DISPATCH

DISPATCH

SECRET

FORM T-2007

TO: Chief, Finance Division

INFO: Chief, WH Division

FROM: Chief of Station, Mexico City

SUBJECT: Pay Account -
Jeremy K. BENADUM

DATE: 13 July 1962

RE: "A" - (CHECK "X" ONLY)

MARKED FOR INDEXING

PRE INDEXING REQUIRED

INDEXING CAN BE JUDGED BY QUALIFIED HQ DESK ONLY

ACTION REQUIRED: For your information

REFERENCES:

MMN-S-2456

1. The Station was surprised to receive the reference, which stated that BENADUM's life insurance application had not been received in Finance Division as of 15 June 1962. Recently we received MMN-S-2450, dated 14 June 1962, which requested that the Station collect from BENADUM the premiums for his life insurance, and no mention was made of payroll deductions we had requested in MMN-T-2800. Therefore, the Station collected the sum of \$72.00 from BENADUM in payment of 6 months premiums. This payment was forwarded to Headquarters under MMN-T-2892.

2. No action will be taken by the Station to change BENADUM's field allotment until notification is received from Headquarters. It would appear that the easiest means of now adjusting his pay account would be to refund the pre-paid premiums and begin payroll deductions for the life insurance.

Willard C. Curtis
WILLARD C. CURTIS

12 July 1962

- DISTRIBUTION:
- 3-Finance Division
 - 2-WH Division
 - 2-Files

*No HQ's funds
How paid through
MMN-S-2456*

FORM T-2007
JULY 1962 EDITION
GPO: 1962 O-557

SECRET

17

15374

S-E-C-R-E-T

LIFE INSURANCE APPLICATION
(CONTRACT LIFE)

POLICY NO. 46
EFFECTIVE DATE 9-25-62
TOTAL PREMIUM PAID 24.00

NAME OF EMPLOYEE (P) James K. Berndtson
9/24/62 FIRST Berndtson M. LAST

DATE OF MONTHLY ANNUAL INSURANCE
DEBT PREMIUM SALARY 13,730 CLASS III

(CHECK APPROPRIATE BLOCK):

Male Full-time Employee
Female Yes No

NAME OF BENEFICIARY (T) Relationship WIFE

DATE SIGNED 14 April, 1962 (P) James K. Berndtson
Signature of Employee

TO : FD.
SUBJECT : Authority to Make Payroll Deductions

I hereby authorize you to deduct the sum of \$12.00 (10%)
per pay period from my salary starting with the pay period beginning
14 Apr, 1962. These deductions are to continue
until terminated by me in writing.

Code 5

James K. Berndtson
(P) Signature

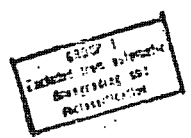

CONFIDENTIAL

U. S. GOVERNMENT PRINTING OFFICE: 1954-375087

1. Name and organizational designation DOP/VH		2. Payroll period	3. Block No.	4. Slip No.
5. Employee's home (and social security account number when appropriate) BENADUM, Jeremy K. (P) Career Agent		6. Grade and salary \$13,730		

PAYROLL CHANGE DATA

	BASE PAY	OVERTIME	GROSS PAY	RET.	FEDERAL TAX	BOND	F. I. C. A.	STATE TAX	GROUP LIFE INS.	NET PAY
7. Previous normal										
8. New normal										
9. Pay this period										

10. Remarks <i>POSTED ON 1/25/62</i>	11. Appropriation(s)	12. Prepared by gah 25 Jan 62
		13. Audited by

Periodic step increase Pay adjustment Other step increase

14. Effective date Apr 62	15. Rate last equivalent increase 30 Oct 60	16. Old salary rate \$13,730	17. New salary rate \$14,055	18. Performance
-------------------------------------	---	--	--	-----------------

LWOP date (fill in appropriate spaces covering LWOP during following periods)
 No excess LWOP, Total excess LWOP
 In pay status at end of waiting period.
 In LWOP status at end of waiting period.

CONFIDENTIAL

PAYROLL CHANGE SLIP — PERSONNEL COPY

STANDARD FORM NO. 1126—Revised
Form prescribed by Comp. Gen., U. S.
October 26, 1954, General Regulations No. 192

0-2-C-1-B-T
(When Filled In)

6/25/63

COMPLETE IN DUPLICATES & RETURN BOTH COPIES TO THE INSURANCE
BRANCH THROUGH APPROPRIATE ADMINISTRATIVE CHANNELS

INSURANCE APPLICATION (COLLECT PLAN) DO NOT WRITE IN THIS BLOCK.

*NAME OF EMPLOYEE
JEREMY K. PENADON
(First) (Initials) (Last)

POLICY NO. 459
EFFECTIVE DATE 6/25/63
CODE 902

DATE OF BIRTH

MONTHLY PREMIUM

(TO BE COMPLETED BY DIVISION)

MARRIED SINGLE

[Redacted Box]

SINGLE PLAN FAMILY PLAN

(PERSON TO CONTACT)

FULL TIME EMPLOYEE YES
 NO

WH/3/10100 2555, 3180
(DIVISION) (EXT.)

J.C. CITIZEN RESIDENT ALIEN

1015 (Room No.)
(ROOM NO.) (FLDG.)

COVERED BY PRESENT "UP" PLAN
 YES NO

DATE OF EMPLOYMENT AS CON-
TRACT EMPLOYEE 31 Dec 1960

*PLEASE NOTE: Name of employee
and Employee's Signature should agree
with the one shown on contract with the
Agency.

EMPLOYEE'S PAYROLL NO. 058865
IS EMPLOYEE PAYROLLED
26 Days Monthly
Bi-weekly

IF FAMILY PLAN COMPLETELY EXISTING:

NAME OF WIFE/HUSBAND

CHILDREN UNDER 19 (A protected person's children shall include unmarried children under age 19. Also, any step-children, legally adopted children, and foster children provided such children are dependent upon the protected person for support and maintenance.)

NAME	DATE OF BIRTH	DATE OF BIRTH
[Redacted]		

I hereby authorize deductions from my salary for payment of premiums under this contract.

APPROVE:
[Redacted Signature]

GROUP 1
Excluded from automatic
deduction of 45%
for retirement

EMPLOYEE'S SIGNATURE
(See instructions)
[Redacted Signature]

Administrative Officer of Division

Date 15 March, 1963

SECRET

Office Memorandum • UNITED STATES GOVERNMENT

TO : Mr. Tolson

DATE: 16 Jul 51

FROM : Mr. [Name]

SUBJECT: [Subject]

Information received by the Medical Staff and [Name] re daily [Subject]

1. [Text]

2. [Text]

SECRET

Re: Banking Institutions

Although writer has bank accounts and accounts in the U.S., he feels that for security reasons it would be preferable to handle all salary payments, less withholdings for retirement, health insurance, withholding for income tax, locally in Mexico.

Mexico, D.F.

19 March, 1961

John W. ...

CERTIFICATION

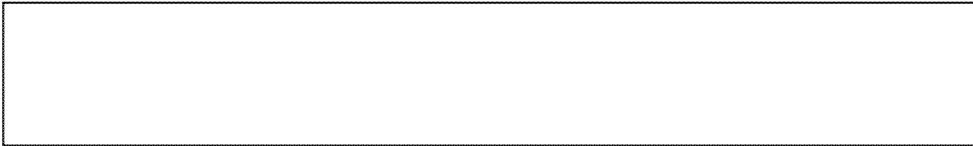

Mexico, D.F.

15 March, 1961

Jeremy K. Benavidez

14-00000

CERTIFICATION

The undersigned hereby certifies that his previous employment by the U.S. Government terminated October 29, 1960, and that final salary payment for this employment covered the period October 16 through October 29, 1960.

Mexico, D.F.

15 March, 1961

Jeremy K. Bonadum

RE: JAMES M. BROWN

TO: SAC, [illegible]

DATE: 10/24/58

RE: [illegible]
TO: [illegible]
DATE: [illegible]

1. The following information and/or documents are submitted in compliance with reference dispatch:

- a. Original Form 8-h signed in person.
- b. Signed statement concerning banking instructions wherein Subject requests that all payments be made locally in person.
- c. Since Subject wants his entire net pay paid locally, it is requested that Headquarters compute his pay and advise Station of the net pay which will represent his local field allotment.
- d. Subject will be reimbursed actual quarters expenses locally, in accordance with FR 45-1050.
- e. BROWN desires the hospitalization contract. Hospitalization Application (Contract Plan) is forwarded herewith in duplicate.
- f. It is requested that Headquarters compute BROWN's pay from 30 October 1960 through the present pay period. Upon advice of the net amount due Subject, Station will collect any overpayments (or pay underpayments) and T/A the correct amount to Headquarters. Hereafter, his net pay will be considered field allotments and amounts paid will be T/A'd to Headquarters.
- g. Certification of BROWN's sick and annual (accumulated) leave and the amount paid in a lump sum by his former employer for "accrued annual leave" are being forwarded in a separate dispatch.
- h. BROWN has been advised by the CON to the effect that he must advise KUMARA before he applies for OFFICE retirement.
- i. Original signed contract is returned herewith. Copy of the contract has been retained for Station files.

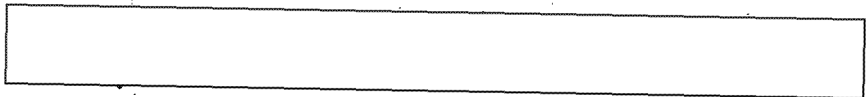

k. Attached are Report of Medical History and certification from the examining physician in accordance with Para. 14(b) of Subject's contract.

2. The Station wishes to make the following additional observations:

- a. Either contract nor 17e-2a(1)(a) letter indicated the amount of "Cost of Living" Allowance Subject will receive, in accordance with Para. 14(b) of his contract. It is presumed that this computation will be received with his pay computation.

b. Subject's contract does not provide for "non-official cover
premium pay" as originally requested by Station. Please advise.

c. Bilateral approval as provided in Para. 1(a) of Subject's
contract will be accounted for and paid locally, if Headquarters has
no objections.

Willard C. GORTIS

14 April 1961

Attachments:
As stated

Distribution:
3 - Headquarters w/att
3 - Files

CONFIDENTIAL

DISPATCH	CLASSIFICATION SECRET	PROCESSING	
		DATE INDEXED	DATE RECORDED
TO Chief of Station, Mexico City		<input type="checkbox"/>	INDEXED FOR INDEXING
INFO		<input checked="" type="checkbox"/>	NO INDEXING REQUIRED
FROM Chief, WH Division		<input type="checkbox"/>	ONLY QUALIFIED MEMBERS USE CAR THIS INDEXING
SUBJECT Jersey E. BENADUM		<input type="checkbox"/>	ABSTRACT
ACTION REQUIRED	REFERENCES	<input type="checkbox"/>	REPLY

ACTION REQUIRED: See paragraphs 2 and 3

REFERENCES: A. IDEP-1802, 25 January 1961
B. WEL-6843, 2 December 1960

1. Attached is a Headquarters contract for Subject effective 30 October 1960, thus giving Subject continuity in his Government service and eligibility to continue his Government retirement. The contract is for the salary of a GS-15 step one.

2. The Station should comply with the following administrative requirements at its earliest convenience.

- a. Submit a W-4 or a Form 313.
- b. Forward banking instructions.
- c. Inform Headquarters whether BENADUM desires a field allotment, the amount, and the effective date.
- d. Inform Headquarters whether the Station plans to give BENADUM a quarters allowance under FR 45-1050. If not, please submit a quarters application.
- e. Does BENADUM want hospitalization per paragraph 8 (e) of his contract? If so, please have him fill out the attached application. The premiums will be deducted from his salary. Information on the policy is also attached for BENADUM's information. (Please refer to Book Dispatch 2220 dated 11 October 1960.)
- f. With regard to the oral agreement, Headquarters could not approve it since it was for \$15,000 per year and not for the first step of a

CONTINUED

Attachments: (HERMATH)
Contract (original and 1)
Memorandum and application for health insurance

Distribution:
1 - Mexico City, w/atts.
1 - Subject
1 - WH/Registry
1 - WH/1/Box/Chrono
1 - FD/SAAS

DATE INDEXED	DATE RECORDED
28 Feb. 1961	2 MAR 1961
DISPATCH SYMBOL AND NUMBER	
WH-4-9513	
201-267227	

03-15, #13,730. The Station has two choices. It can collect all monies paid to BENADUM under his oral agreement, whereupon Headquarters can effect payment of salary and allowances effective 30 October 1960. Or an alternative method would be for the Station to notify Headquarters of a breakdown of what has been paid BENADUM, on the basis of which Headquarters would start payrolling BENADUM, deducting any overpayment of salary from net salaries due. Please advise Headquarters which method the Station and BENADUM prefer.

g. In order to establish BENADUM's leave record with KUBARK, BENADUM should furnish any final pay slip he might have received, which would reflect the amount of annual and sick leave he had as of his date of resignation and also, his salary rate at the time of resignation. If BENADUM has no such slip, a certified statement of the above is required. Since BENADUM's contract is effective 30 October 1960, the day after the end of his annual leave for 1960, BENADUM must return to AOEANA the gross amount he received from ODENVY for his "accrued carry-over" of 633 hours.

h. BENADUM should be told that he must advise KUBARK, should he still be in our employ, before he applies for ODENVY retirement for which he will be eligible when he becomes 50 years of age because of his ODENVY service.

3. The Station should return to Headquarters the original signed copy of the attached contract. The copy may be retained by the Station.

END OF DISPATCH

TO: [REDACTED]

FROM: DIRECTOR

CONF: SECRET

INFO: CDD 2, OP 2, 3/0 2

21 FEB 61 10 06z

ROUTINE
00170099
01 099

TO: [REDACTED] (FOR [REDACTED]) INFO: [REDACTED]

CITE OR: 26357
26357

SOCALM

REF: DEAR-1233 (IN 45643)*
TALZ-0179 (IN 47450)**

1. SUGGEST [REDACTED] MEET AND BRIEF [REDACTED] PRIOR 15 MARCH. [REDACTED] ADVISE [REDACTED] VIA [REDACTED] STA [REDACTED] AND CONTACT PLAN.
2. KUBARK CONTRACT FOR T POUCHED [REDACTED] FOR SIGNATURE. [REDACTED] SHOULD BE IN THEIR EFFORTS 15 MARCH.

END OF MESSAGE

* [REDACTED] STA 15 MARCH [REDACTED] TO SIGN ICA CONTRACT.
** [REDACTED] PLANS TO RE IE [REDACTED] UNTIL 15 MARCH.

1/E/SS
CFM/2/

RE/CO:

SECRET

REPRODUCTION BY OTHER THAN THE ISSUING OFFICE IS PROHIBITED

Copy No.

DISPATCH

Chief of Station, Mexico City	SEARCHED	INDEXED
Chief, NY Division	SERIALIZED	FILED

Jeremy K. BERNARD

ACTION REQUIRED: See paragraphs 2 and 3

- REFERENCES :
- A. WWT-1008, 23 January 1961
 - B. BSI-684, 2 December 1960

1. Attached is a Headquarters contract for Subject effective 30 October 1960, thus giving Subject continuity in his Government service and eligibility to continue his Government retirement. The contract is for the salary of a GS-15 step one.

2. The station should comply with the following administrative requirements at its earliest convenience.

- a. Advise HQ of a Form 50.
- b. Forward heading instructions.
- c. Inform Headquarters whether BERNARD desires a field allotment, the amount, and the effective date.
- d. Inform Headquarters whether the Station plans to give BERNARD a quarters allowance under FE 15-1030. If not, please submit a quarters application.
- e. Does BERNARD want hospitalization per paragraph 3 (c) of his contract? If so, please have him fill out the attached application. The premium will be deducted from his salary. Information on the policy is also attached for BERNARD's information. (Please refer to Book Dispatch 5120 dated 11 October 1961.)

3. With regard to the oral agreement, Headquarters could not approve it since it was for \$15,000 per year and not for the first step of a

CONTINUED

Attachments: (BERNARD)
 Contract (original and 1)
 Memorandum and application for health insurance

- Distribution:
- 3 - Station, Mexico City, et al.
 - 1 - Subject
 - 1 - NY/Registry
 - 1 - NY/1/No. 1/Office
 - 1 - FD/IAS/

DATE TYPED	DATE CHECKED
23 Feb. 1961	
SEARCHED	INDEXED
SERIALIZED	FILED
201-55727	

CLASSIFIED MESSAGE

DATE : 550
1 DEC 60

SECRET

ROUTING			
1		4	
2		5	
3		6	

TO : DIRECTOR

FROM : MEXICO CITY

ACTION : C/WH 2

INFO : COP, C/CCD 2, C/CI, DD/S, SEA, D/OP, D/OS 2, S/C

DEC 2 0022Z 60

PRIORITY

IN 10827

PRITY DIR CITE MEXI 6843

RYBAT

PUGH FROM CURTIS

REF A MEXI 6677 (1138281)

B DIR 13219 (cont 95542)

cc (S. ...)

1. JEREMY K. BENADUM'S CURRENT ANNUAL LEAVE TERMINATED 29

OCTOBER PERIOD COVERED BY ACCUMULATED ANNUAL LEAVE ENDS 14 FEBRUARY

1961. BENADUM RECEIVED LUMP SUM CHECK FOR ACCUMULATED ANNUAL LEAVE

WHICH HE WILL ENDORSE AND SEND TO KUBARK.

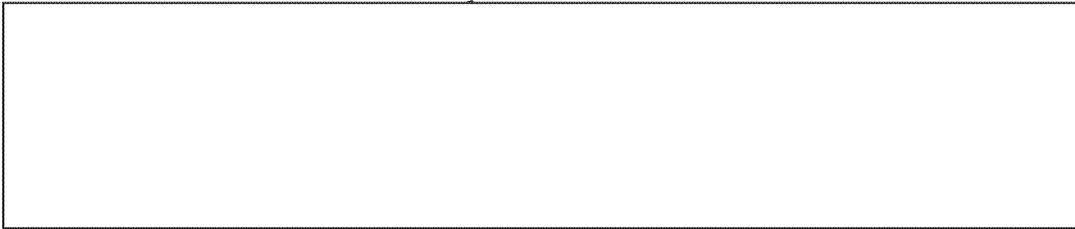

SECRET

REPRODUCTION BY OTHER THAN THE ISSUING OFFICE IS PROHIBITED.

Copy No.

SECRET

REF: 6843
14 10827

2
PAGE

[Redacted]

[Redacted]

A. STATION CONCURS IT IMPERATIVE EBNADUM/KUBARK TRUE RELATIONSHIP BE KEPT ON NEED TO KNOW BASIS.

[Redacted]

[Redacted]

SECRET

REPRODUCTION BY OTHER THAN THE ISSUING OFFICE IS PROHIBITED

[Redacted]



E. FROM OPERATIONAL SECURITY POINT ^F OF VIEW STATION OPPOSED

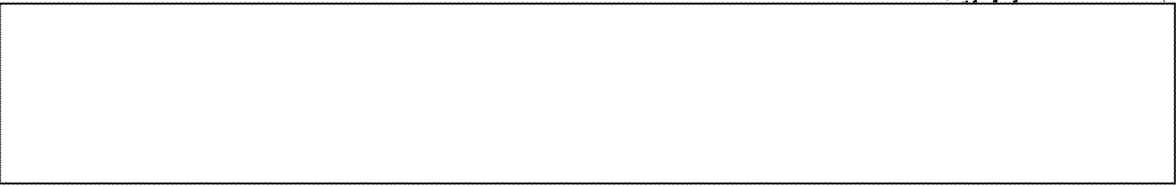
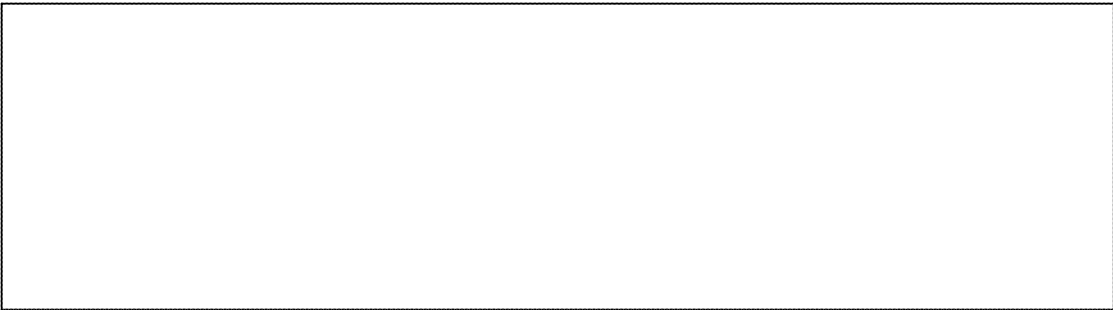

SECRET

REPRODUCTION BY OTHER THAN THE ISSUING OFFICE IS PROHIBITED

4. STATION OF OPINION THAT BEST WAY AVOID SITUATION WITH ODENVY WITHOUT REVEALING THE MORE IMPORTANT FACTS IS FOLLOWING PROCEDURE:

A. IF ODENVY HAS TO KNOW OF OFFICIAL BENADUM/KUBARK RELATIONSHIP ADVISE ODENVY THROUGH LIAISON CHANNELS THAT KUBARK DESIRES SECURITY CLEARANCE FOR DISCUSSION CLASSIFIED MATERIAL WITH BENADUM AS "CONFIDENTIAL CONTACT OF CURTIS"

B. ODENVY WILL BE PLACED ON NOTICE THAT STATION IN CONTACT WITH BENADUM BUT WOULD NOT REVEAL FULL DETAILS OF TRUE KUBARK/BENADUM RELATIONSHIP.

C. PROCESSING OF THIS INFORMATION THROUGH LIAISON CHANNELS RATHER THAN KUSODA WOULD TEND DISPEL IMPRESSION BENADUM EMPLOYED FULL TIME BY KUBARK.

SECRET

REPRODUCTION BY OTHER THAN THE ISSUING OFFICE IS PROHIBITED

SECRET

MEXI 6843

PAGE

5

D. TO TELL ODENVY ONLY PART OF WHAT WOULD BE BROUGHT BASIS TO REFUTE ANY ARGUMENTS IN CASE ODENVY DECIDES MAKE ISSUE OF MATTER. BUT STATION UNABLE UNDERSTAND WHAT RIGHT ODENVY HAS TO MAKE ISSUE OF KUBARK HIRING OF FREE AND UNEMPLOYED PEPRIME CITIZEN.

5. IF HQS CONSIDERES IT IMPERATIVE THAT ODENVY BE ADVISED THIS MATTER IMMEDIATELY STATION REQUESTS THAT CONSIDERATION BE GIVEN EXPIRATION DATE OF BENADUM'S ACCUMULATED ANNUAL LEAVE MENTIONED IN PARA 1 AND THAT ODENVY BE ADVISED AFTER 14 FEB OF INTENTION USE BENADUM AS STATION (COS) CONTACT.

6. RE SAM PAPICH INQUIRIES, BENADUM ADVISES THAT PAPICH IS FRIEND OF LONG STANDING WHOSE INQUIRIES HAVE BEEN PERSONAL RATHER THAN DIRECTED BY ODENVY.

END OF MESSAGE

SECRET

REPRODUCTION BY OTHER THAN THE ISSUING OFFICE IS PROHIBITED

CLASSIFIED MESSAGE

SECRET

DATE: 11/5/60

TO: DIRECTOR

FROM: MEXICO CITY

ACTION: C/MH 2

INFO: COP, C/CCD 2, C/CI, DD/S, SSA, D/OP, D/CS 2, S/C 2

ROUTINE	
1	4
2	5
3	6

NOV 5 0709Z 60

ROUTINE

IN 38281

DIR CITE MEXI 6677

RYBAT

REF DIR 62217 (act 87521) #

1. SUBJ WISHES CAREER AGENT STATUS WITH FOLLOWING:

- A. KUBARK RETIREMENT WITH ANY LEGAL ADJUSTMENTS FOR FUTURE;
- B. TERMINAL LEAVE ENDED 29 OCT EXCEPT FOR "ACCRUED CARRY-OVER" OF 633 HOURS. SUBJ WISHES GIVE AMOUNT RECEIVED FOR THIS TO KUBARK AND HAVE THIS 633 CARRIED OVER.
- C. REQUEST BEGIN ON KUBARK PAYROLL ON 1 NOV. AS KNOWN TO [REDACTED] SUBJ HAS BEEN WORKING FOR SEVERAL WEEKS FOR KUBARK WITHOUT PAY.

[REDACTED]

E. FORWARDING COPIES OF LETTER FROM HEAD ODENVY CONGRATULATING SUBJ ON COMPLETION TWENTY YEARS SERVICE, SUBJ'S LETTER OF RESIGNATION AND LETTER OF ACCEPTANCE. COS CAN PERSONALLY ASSURE CHIEF, KUSODA THAT SUBJ WAS IN GOOD STANDING WITH ODENVY AT TIME OF RESIGNATION.

2. COS STRONGLY URGED THAT NO REPEAT NO CHECK BE MADE WITH ODENVY [REDACTED] ON SUBJECT OR ON LITEMPO/1. ANY CHECK, DISCREET OR OTHERWISE, WILL

SECRET

REPRODUCTION BY OTHER THAN THE ISSUING OFFICE IS PROHIBITED.

Copy No.

SECRET

NEAR WORK OF MY CHIEF NOTIFIED WITHIN TWENTY-FOUR HOURS THAT I WAS EMPLOYED BY RUSSIA. THIS WOULD ENDANGER SECURITY OF LITENPO OPERATIONS, WOULD PREJUDICE LITENPO 1 AND LITENPO 2 (ODENVY HAS "LIAISON ON CRIMINAL MATTERS" WITH LITENPO 2).

3. COS AGREES THAT AFTER A TIME A CHECK COULD BE MADE WITH ODENVY BUT AT PRESENT SUCH CHECK

[REDACTED]

4. APPRECIATE REF CABLE AND REQUEST ADVICE ON ANY ACTIONS STATION CAN TAKE TO FACILITATE AND SPEED APPROVAL OF PROJECT AND HIRING OF SUCC.

END OF MESSAGE

C/S COMMENT: *SUGGESTED STATION RECONSIDER AND USE CAREER OR CONTRACT STATUS, IF STILL PREFERRED STAFF AGENT STATUS, SUBMIT DETAILED JUSTIFICATION CHOICE.

SECRET

CLASSIFIED MESSAGE

SECRET

UNIT: WH/3/MEXICO 538
EXT: 2555
DATE: 31 OCTOBER 1960

ROUTING			
1		4	
2		5	
3		6	
DEFERRED		DETAILS	
ROUTINE		DETAILS	
PRIORITY		DETAILS	
OPERATIONAL IMMEDIATE		DETAILS	

87521

TO: MEXICO CITY
FROM: DIRECTOR
COMP: C/MH 2
INFO: COP, C/CCD 2, C/CI, D/OP, D/CS 2, S/C 2, DD/S, SS

P
R
O
C
E
D
U
R
E

TO MEXI INFO CITY DMS 09817
NYRAT 09817
REF: HMT 1610 9

1. CHOICE STAFF AGENT STATUS RATHER THAN CAREER OR CONTRACT AGENT STATUS FOR SUBJ MUST BE JUSTIFIED IN DETAIL TO KUDOVE AGENT PANEL WHICH IN PAST KNOWN TO FAVOR CAREER AGENT STATUS FOR THIS TYPE INDIVIDUAL. IF PANEL APPROVES STAFF STATUS THAT SUBJECT CASE TO CHIEF KUDOVE WHO MUST APPROVE EXCEPTION TO KUDOVE POLICY OF NO KIND OF STAFF TYPE PROFESSIONAL EMPLOYEES AT HIGH GRADES.

2. SUGGEST STATION RECONSIDER AND USE CAREER OR CONTRACT STATUS. IF STILL PREFER STAFF AGENT STATUS SUBMIT REBILLED JUSTIFICATION DECOR.

3. DOES SUBJ WANT MILITARY RETIREMENT BENEFITS? UNDER CAREER/STATUS AGENT MAY HAVE RETIREMENT OR SOCIAL SECURITY.

4. UNDER STAFF OR CAREER/STATUS CAREER? PICK UP SUBJ UNTIL END OF PAID TERMINAL LEAVE PERIOD HOWEVER SUBJ MAY ASK TO ANNUAL AND SICK LEAVE ACCRUED AS OF END EMPLOYMENT COVERED AND REQUESTS MILITARY FOR ALL UNUSED ANNUAL LEAVE WHICH CAN BE CREDITED TO MILITARY SERVICE. ADVISE DATES TERMINAL LEAVE PERIOD AND CHOICE.

COORDINATING OFFICERS

DISSEMINATING OFFICERS

SECRET

AUTHENTICATING OFFICERS

REPRODUCTION BY OTHER THAN THE ISSUING OFFICE IS PROHIBITED.

Copy File

CLASSIFIED MESSAGE

SECRET

OFFIC:
UNIT:
EXT:
DATE:

ROUTING			
1		4	
2		5	
3		6	

TO:
FROM: DIRECTOR
CONF:
INFO:

PAGE 2

P R E C E D E N C E	DEFERRED	
	ROUTINE	
	PRIORITY	INITIALS
	OPERATIONAL IMMEDIATE	INITIALS

CUT 87521 DIR 09217

TO INFO CITE DIR

5. [REDACTED] STATION MAY WISE CONSIDER CONTRACT AGENT STATUS IF OFFSET CLAUSE APPLICABLE.

6. FORWARD HQS COPY ~~OF~~ RESIGNATION ACTION SUBJ AND REASONS SUBJ'S RESIGNATION.

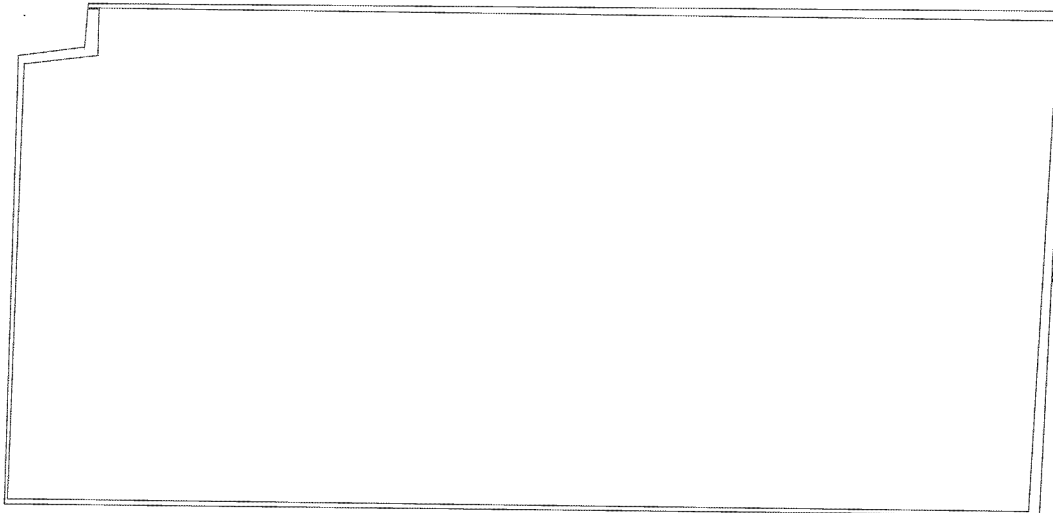

*MH Comment: Subject is George Mauro

MH/Pers/ [REDACTED]

END OF MESSAGE

CPD/ [REDACTED]

Agent Panel/ [REDACTED]

D/IB/OS/ [REDACTED]

CI/CPS/ [REDACTED]

COORDINATING OFFICERS

J. C. [REDACTED]
C/MRD

RELEASING OFFICERS

SECRET

AUTHENTICATING OFFICERS

REPRODUCTION BY OTHER THAN THE ISSUING OFFICE IS PROHIBITED.

Copy 1/1

Mr. Jeremy K. Benadum

Dear Mr. Benadum:

The United States Government, as represented by the Contracting Officer, hereby contracts with you for your services as a Career Agent under the following terms and conditions:

1. Status. Your status is that of a Government employee under contract and, as such, your rights and benefits are governed by the provisions of this agreement. It is specifically understood that you are not entitled to rights and benefits pertaining to appointed staff status, except as provided herein.

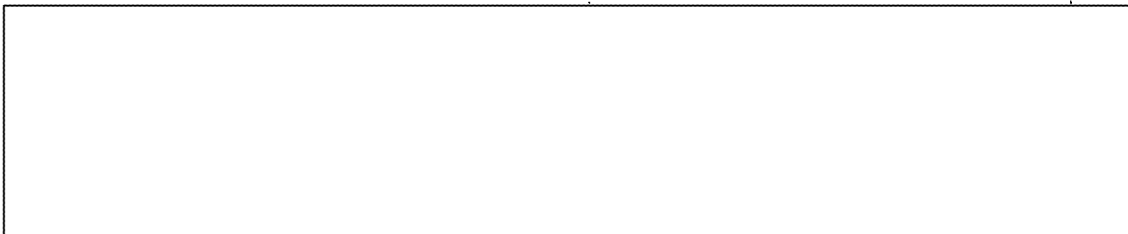

3. Compensation and Taxes. For your services as a Career Agent, you will be compensated at a basic salary of \$13,730 per annum, the equivalent of a GS-15. You will be entitled to within grade promotions and legislative pay adjustments in substantial conformance with rules and regulations applicable to Government appointed personnel. Payments will be made as requested by you in writing in a manner acceptable to the Government. Monies paid you directly or guaranteed by the Government under this paragraph constitute income for Federal tax purposes. You will be advised as to the method to be followed in reporting and paying such taxes. The method as well as the procedures used by this organization to implement its tax reporting responsibilities will be based primarily upon [redacted] requirements. Unless precluded by such requirements, taxes will be withheld therefrom and submitted by this organization.

4. Allowances. You will be entitled to: (a) living quarters allowances in conformance with applicable Government regulations. You may be provided quarters by your cover facility or the Government and, in such event, you will not be entitled to the living quarters allowances herein indicated.

(b) Cost of living allowances in conformance with applicable Government regulations including, but not limited to, an education allowance.

5. Travel. You will be advanced or reimbursed funds for authorized operational travel. In addition, upon the completion of each two (2) years of successful overseas service under this contract, you may be authorized home leave travel expenses for you and your dependents from your permanent post of duty overseas to your place of recorded residence in the United States and return travel expenses to your permanent post of duty overseas provided, however, that you have fulfilled any other requirements relating to home leave which are applicable to Government appointed employees. You may be entitled to per

diem in lieu of subsistence in the course of all travel pursuant herunder and, when authorized, for you alone while on temporary duty away from your permanent post of assignment. All travel, transportation and per diem provided for under this paragraph must be properly authorized, and expenses incurred hereunder are subject to payment and accounting in compliance with applicable Government regulations [redacted] whichever is directed by the Government.

6. Operational Expenses. You will be advanced or reimbursed funds for necessary operational expenses including, but not limited to, entertainment and the purchase of information, as specifically approved by the Government. Such funds will be subject to accounting in compliance with Government regulations [redacted] whichever is directed by the Government.

7. Repayment. It is recognized that your failure to account for or refund any monies advanced you hereunder shall entitle the Government [redacted] [redacted] to withhold the total amount of such indebtedness or any portion thereof from any monies due you under the terms of this contract in such manner as it deems appropriate.

8. Benefits. (a) You will be entitled to death and disability benefits equal to those authorized under the Federal Employees' Compensation Act, as amended. Claims by you, your heirs, or legal representatives under this paragraph will be processed by this organization in accordance with its procedures in such manner as not to impair security.

(b) You will be entitled to the continuance of pay and allowances in a manner similar to that set forth in the Missing Persons Act (50 U.S.C.A., App. 1901-1915).

(c) You will be entitled to sick and annual leave equal to and subject to the same rules and regulations applicable to Government employees. Annual leave may only be taken at times and places approved in advance by appropriate Government representatives.

(d) Your Civil Service retirement status is preserved by virtue of the fact that you have transferred without a break in service from a position subject to Civil Service retirement deductions to your present status as an employee of the Government under contract. Contributions to the Civil Service Retirement Fund will be deducted by the Government from the basic compensation due you hereunder, i.e., presently \$13,750 per annum. In the event circumstances of your cover warrant or require contributions to social security, such contributions will be at your expense and you will not be reimbursed therefor by the Government.

(e) (1) This organization is authorized to pay the cost of necessary hospitalization and related travel expenses for illness or injury incurred by a United States citizen full-time Career Agent in the line of duty while permanently assigned abroad.

(2) This organization may pay certain necessary costs of hospitalization and related travel expenses for illness or injury incurred by

the dependents of a United States citizen full-time Career Agent permanently assigned abroad, while they are located abroad.

It is understood and agreed that the eligibility and extent of the participation by you and your dependents in the above medical programs will be in conformance with the rules, regulations and policies of this organization in effect at the time an illness or injury is incurred, that all claims will be submitted only to this organization and that adjudication of such claims by this organization shall be final and conclusive.

(f) You are herein authorized to apply for enrollment in a health insurance program for certain selected Career Agents of this organization, subject to all the terms and conditions of that program. If accepted, this organization is presently authorized to bear a portion of the premium cost, you will bear the remainder. Your financial contribution will be effected either by payroll deduction or by direct remittance at periodic intervals to be established by this organization.

(g) You will be entitled to claim reimbursement for loss of personal property pursuant to Government regulations pertaining thereto.

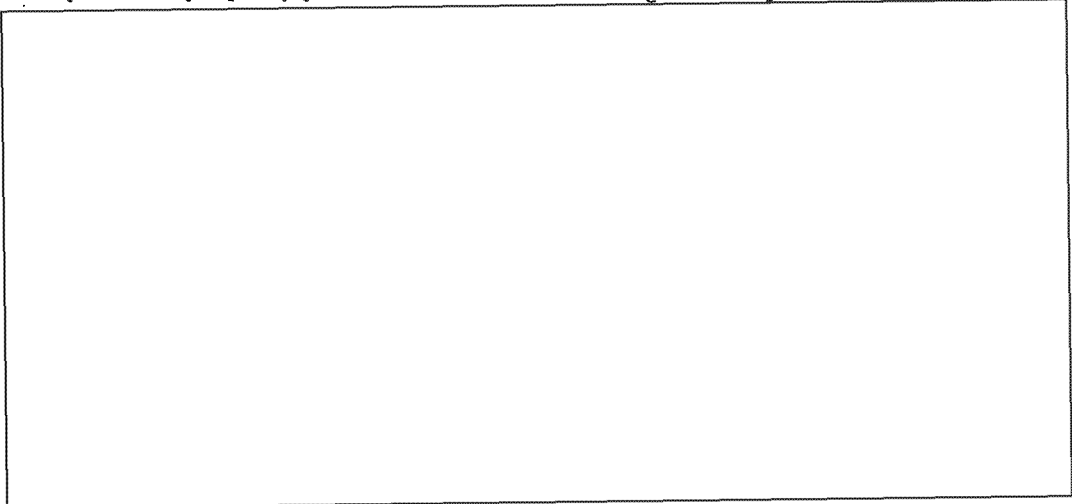

10. Execution of Documents. If, in the performance of services under this contract, you assume the custody of Government funds or take title of record to property of any nature whatsoever and wherever situate, which property has in fact been purchased with monies of the U. S. Government, you hereby recognize and acknowledge the existence of a trust relationship, either express or constructive, and you agree to execute whatever documents may be required by the Government to evidence this relationship.

11. Secrecy. You will be required to keep forever secret this contract and all information which you may obtain by reason hereof (unless released in writing by the Government from such obligation), with full knowledge that violation of such secrecy may subject you to criminal prosecution under the Espionage Laws, dated 25 June 1948, as amended, and other applicable laws and regulations.

12. Instructions. Instructions received by you from the Government in briefing, training or otherwise are a part of this contract and are incorporated herein, provided that such instructions are not inconsistent with the terms hereof.

13. Unauthorized Commitments. No promises or commitments pertaining to rights, privileges or benefits other than those expressly stipulated in writing in this agreement or any amendment thereto shall be binding on the Government.

14. Term. This contract is effective as of 30 October 1960, and shall continue thereafter for an indefinite period unless sooner terminated either:

(a) Upon thirty (30) days' actual notice by either party hereto, or

(b) Upon actual notice to you in the event the results of an initially required medical examination are determined by this organization to be unsatisfactory, or

(c) Without prior notice by the Government, in the event of a breach of this contract by your violation of the security provisions hereof or by your otherwise rendering yourself unavailable for acceptable service.

Termination of this agreement will not release you from the obligations of any security oath you may be required to take.

UNITED STATES GOVERNMENT

BY _____
Contracting Officer

ACCEPTED:

Jeremy K. Benadum

WITNESS: _____

APPROVED:

10/30/60
10/30/60

CONTRACT INFORMATION AND CHECK LIST

INSTRUCTIONS: This form is to be filled out by the contractor and submitted to the appropriate extension office. Forward original and one copy to the appropriate extension office. **2575/2162** **15 November 1960**

1. NAME: Individual Firm
Jeremy K. BENJAMIN
25. PROJECT: **LITERNO**
26. PERMANENT STATION: **Mexico City**
3. ALLIANCE NO.:
4. SLOT NO.:

5. PREVIOUS CIA EMPLOYMENT OR ALIASES: **None**
6. INDIVIDUAL IS PREVIOUSLY ENGAGED, OR HAS BEEN ENGAGED BY CIA OR ITS ALLIED ACTIVITIES IN SOME CAPACITY: YES NO (If yes, describe and include dates)

7. SECURITY CLEARANCE (Type and date): **CSC - Requested 10 Nov 1960**
8. CONTRACT IS TO BE WRITTEN IN STERILE FORM I.E., "U.S. GOVERNMENT": YES NO

9. INDIVIDUAL WILL WORK UNDER "CONTROLLED CONDITIONS" I.E., REGULAR OFFICE HOURS AWAY FROM SUBJECT'S HOME AND PERFORMED UNDER THE SUPERVISION OF A STAFF EMPLOYEE OR STAFF AGENT: YES NO
10. PROPOSED CATEGORY (Contract agent, contract employee, etc.): **Career Agent**

SECTION II PERSONAL DATA

11. CITIZENSHIP: **USA**
12. IF NOT U.S. CITIZEN, INDIVIDUAL IS A PERMANENT RESIDENT ALIEN: YES NO
13. AGE: **45**
14. DATE OF BIRTH (Month, day, year):

15. LEGAL RESIDENCE (City and state or country):
16. CURRENT RESIDENCE (City and state or country): **Mexico City, Mexico**

17. MARITAL STATUS (Check as appropriate):
 SINGLE MARRIED DIVORCED SEPARATED WIDOWED

18. NUMBER OF DEPENDENTS (Not including individual) RELATIONSHIP AND AGE:
19. INDIVIDUAL IS RELATED TO A STAFF EMPLOYEE, STAFF AGENT OR AN INDIVIDUAL CURRENTLY WORKING FOR THE AGENCY IN SOME CAPACITY: YES NO (If yes, describe relationship)

SECTION III U.S. MILITARY STATUS

20. RESERVE: **NO**
21. VETERAN: **YES**
22. IF SERVED, INDICATE CATEGORY (Longevity, combat disability, service disability non-combat):

23. BRANCH OF SERVICE: **US Army**
24. RANK OR GRADE: **1st Lt.**
25. DRAFT ELIGIBLE: YES NO
26. DRAFT DEFERMENT OBTAINED BY CIA: YES NO

SECTION IV COMPENSATION

27. BASIC SALARY: **\$13,730**
28. POST DIFFERENTIAL:
29. COVER (Breakdown, if any): **None**
30. TAXES TO BE WITHHELD BY: COVER CIA NOT WITHHELD

SECTION V ALLOWANCES (NORMALLY GRANTED ONLY TO RESIDENTS OF THE UNITED STATES)

31. QUARTERS: **Yes**
32. POST:
33. OTHER: **Cost - per LWA, 10% Staff and Motivation for Staff Agents**

34. COVER (Breakdown, if any): **Education Allowance**

SECTION VI TRAVEL

35. TRIPS: DOMESTIC OPERATIONAL FOREIGN OPERATIONAL
36. WITH DEPENDENTS: YES NO

37. HOUSEHOLD EFFECTS TO BE SHIPPED: YES NO
38. PERSONAL VEHICLE TO BE SHIPPED: YES NO
39. TRANSPORTED VEHICLE TO BE USED FOR OPERATIONAL TRAVEL: YES NO

40. IF WITH DEPENDENTS STATE RELATIONSHIP, CITIZENSHIP, AGE AND DATE OF BIRTH

41. PAYMENT AND ACCOUNTABILITY WILL BE IN CONFORMANCE WITH: THE REGULATIONS OTHER REGULATIONS AND PROCEDURES

SECTION VII OPERATIONAL EXPENSES

42. PAYMENT OF INFORMATION: **Yes**
43. ENTERTAINMENT:
44. OTHER:

45. PAYMENT AND ACCOUNTABILITY WILL BE IN CONFORMANCE WITH: THE REGULATIONS OTHER REGULATIONS AND PROCEDURES

CONTRACT INFORMATION AND CHECK LIST
(CONTINUED)

W. I. ZELIGER
SUPERVISOR CONTRACT NO.

2595/3162

15 November 1960

All those normally given a Career Agent including retirement. For more details please refer to IN 38281 dated 5 November 1960 from Mexico City.

SECTION III - COVER ACTIVITY

87. STATE (Foreign)	PROPOSED	88. TYPE (Contract)	89. OCCASIONAL	90. TEMPORARY	91. FULL TIME	92. COMMERCIAL	93. MILITARY	94. OTHER
	<input checked="" type="checkbox"/>		<input type="checkbox"/>	<input type="checkbox"/>	<input type="checkbox"/>	<input checked="" type="checkbox"/>	<input type="checkbox"/>	<input type="checkbox"/>

95. IF OTHER PAYMENTS ARE CONTEMPLATED, THEY WILL BE EFFECTED ON REIMBURSABLE BASIS

YES NO COMPLETE PARTIAL

SECTION IV - SOURCE OF INCOME

96. SOURCE OF INCOME AND STATE EMPLOYMENTS DERIVED FROM COVER ACTIVITIES (If less than total, justify in separate sheet attached hereto.)

NONE PARTIAL NONE No income from cover

SECTION V - TERM

97. DURATION indefinite

98. RENEWABLE YES NO

99. TERMINATION NOTICE (Number of days) 30 October 1960

100. EXTENSION OF RETURN TRAVEL FOR DESIGNATION PRIOR TO CONTRACT TERMINATION YES NO

SECTION VI - FUNCTION

101. PRIMARY FUNCTION (PI, PP, other) PI/CE

SECTION VII - DUTIES

102. GENERAL DESCRIPTION OF DUTIES TO BE PERFORMED

run surveillance team

SECTION VIII - QUALIFICATIONS

103. EXPERIENCE

20 years employment with FBI

SECTION IX - EDUCATION

104. EDUCATION (Check Highest Level Attained)	GRADE SCHOOL	HIGH SCHOOL GRADUATE	TRADE SCHOOL GRADUATE
	COLLEGE SCHOOL GRADUATE	COMMERCIAL SCHOOL GRADUATE	

105. LANGUAGE COMPETENCY

105. LANGUAGE COMPETENCY (Check Appropriate Degree Competency)	LANGUAGE	FLUENT	INTERMEDIATE	POOR	FLUENT	AVERAGE	POOR	FLUENT	AVERAGE	POOR	106. INDIVIDUAL'S COUNTRY OF ORIGIN
	Spanish	X			X			X			USA
	German			X						X	
	French			X						X	

SECTION X - AREA KNOWLEDGE

Latin America

SECTION XI - PRIOR EMPLOYMENT

107. JOB AND SALARY PRIOR TO SERVICE FOR CIA

FBI - GS-14, \$13,000

108. ADDRESS (Last Page)

Secretary, CACOS

SECTION XII - ADDITIONAL INFORMATION

109. ADDITIONAL OR UNUSUAL REQUIREMENTS, JUSTIFICATIONS OR EXPLANATIONS (Use other side if necessary)

NOTE: This X is based strictly on a Mexico C.A. PCS - not in service domain DE

SECTION XIII - APPROVAL

110. DATE AND TIME

111. TYPED NAME & SIGNATURE OF REQUESTING OPERATOR

112. TYPED NAME & SIGNATURE OF CONTRACT APPROVING OFFICER

CLASSIFIED MESSAGE

DATE : 07/60

SECRET

ROUTINE	
1	4
2	5
3	6

TO : DIRECTOR

FROM : MEXICO CITY

ACTION : C/WH 2

INFO : COP, C/CCO 2, C/CI, CC/S, SSA, D/OP, S/CS 2, S/C 2

NOV 5 0709Z 60

ROUTINE

IN 33231

DIR CITE MEXI 6677

RYBAT

REF DIR 60217 (C-1 87571)

1. SUBJ WISHES CAREER AGENDA LISTED WITH FOLLOWING:

- A. KUBARK RETIREMENT WITH ALL LEGAL ADJUSTMENTS FOR FUTURE;
- B. TERMINAL LEAVE ENDED 20 OCT EXCEPT FOR "ACCUMULATED BY-OVER" OF 633 HOURS. SUBJ WISHES CIVIL SERVICE ADJUSTED FOR THIS TO KUBARK AND HAVE THIS 633 CARRIED OVER.
- C. REQUEST BEGIN ON NOV. 1 1960 ON 1 NOV. AS KNOWN TO [REDACTED] SUBJ HAS BEEN WORKING FOR CIVIL SERVICE SINCE KUBARK EFFECT DATE.

[REDACTED]

E. FORWARDING COPIES OF LETTER FROM LOCAL COUNTY CONGRATULATING SUBJ ON COMPLETION OF 20 YEAR SERVICE, LOCAL LEVEL OF ASSIGNATION AND LETTER OF ACCEPTANCE, COPY TO [REDACTED] AND [REDACTED] THAT WOULD BE IN GOOD STANDING FOR COUNTY RE VIEW OF ASSIGNATION.

D. CCC STRATEGY UNIT. [REDACTED] CHECK IS MADE WITH COUNTY

ON SUBJECT OF ON LETTER [REDACTED]

[REDACTED]

CLASSIFIED MESSAGE

SECRET

1977

PAGE 2

... EMPLOYED AS ... THE ... TION, WOULD ... IN ORIGINAL ...

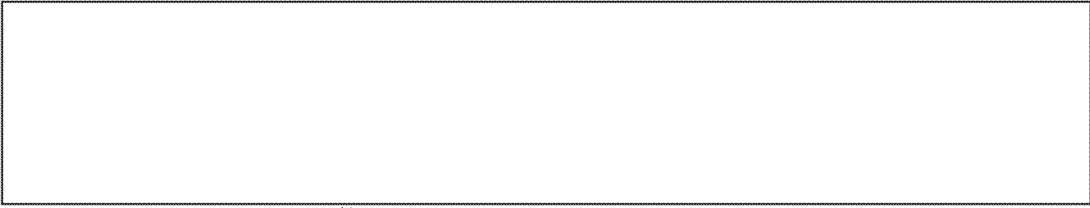

4. APPRECIATE REF CABLE AND REQUEST ADVICE ON ANY ACTIONS STATION CAN TAKE TO FACILITATE AND SPEED ...

END OF MESSAGE

C/S COMMENT: *SUGGESTED STATION RECONSIDER AND USE CAREER OR CONTRACT STATUS, IF STILL PREFERRED STAFF AGENT STATUS, SUBMIT DETAILED JUSTIFICATION CHOICE.

SECRET

ORIG: [REDACTED]
UNIT: WH/3/MEXICO 538
EXT: 2555
DATE: 31 OCTOBER 1960

CLASSIFIED MESSAGE

SECRET

ROUTING	
1	[REDACTED]
2	[REDACTED]
3	[REDACTED]
DEPARTED	[REDACTED]
<input checked="" type="checkbox"/> ROUTINE	[REDACTED]
PRIORITY	INITIALS
OPERATIONAL IMMEDIATE	INITIALS

TO: MEXICO CITY
FROM: DIRECTOR
CONF: C/WH 2
INFO: COP, C/CCD 2, C/CI, D/OP, D/OS 2, S/C 2, DD/S, SS

87521

TO: MEXI INFO CITE DIR 09217

RIBAT

REF: HMT 1610 #

Jeremy K. [Signature]

1. CHOICE STAFF AGENT STATUS RATHER THAN CAREER OR CONTRACT AGENT STATUS FOR SUBJ MUST BE JUSTIFIED IN DETAIL TO KUDOVE AGENT PANEL WHICH IN PAST KNOWN TO FAVOR CAREER AGENT STATUS FOR THIS TYPE INDIVIDUAL. IF PANEL APPROVES STAFF STATUS THEY SUBMIT CASE TO CHIEF KUDOVE WHO MUST APPROVE EXCEPTION TO KUDOVE POLICY OF NO HIRING OF STAFF TYPE PROFESSIONAL EMPLOYEES AT HIGH GRADES.

2. SUGGEST STATION RECONSIDER AND USE CAREER OR CONTRACT STATUS. IF STILL PREFER STAFF AGENT STATUS SUBMIT DETAILED JUSTIFICATION CHOICE.

3. DOES SUBJ WANT KUBARK RETIREMENT BENEFITS? UNDER CAREER/STATUS AGENT MAY HAVE RETIREMENT OR SOCIAL SECURITY.

4. UNDER STAFF OR CAREER/STATUS CANNOT PICK UP SUBJ UNTIL END OF PAID TERMINAL LEAVE PERIOD HOWEVER SUBJ MAY ATTEST TO ANNUAL AND SICK LEAVE ACCRUED AS OF END EMPLOYMENT ODENVY AND REIMBURSE KUBARK FOR ALL UNUSED ANNUAL LEAVE WHICH CAN BE CREDITED TO HIM UNDER KUBARK. ADVISE DATES TERMINAL LEAVE PERIOD AND CHOICE.

COORDINATING OFFICERS
RELEASING OFFICERS **SECRET** AUTHENTICATING OFFICERS

REPRODUCTION BY OTHER THAN THE ISSUING OFFICE IS PROHIBITED.

Copy No.

CLASSIFIED MESSAGE

SECRET

ORIG:
UNIT:
EXT:
DATE:

ROUTING	
1	4
2	5
3	6

TO:
FROM: DIRECTOR
CONF:
INFO:

P R E C E D E N C E	DEFERRED	
	ROUTINE	
	PRIORITY	INITIALS
	OPERATIONAL IMMEDIATE	INITIALS

PAGE 2

CUT 87521 DIR 09217

TO

INFO

CITE DIR

5. [] STATION MAY WISH CONSIDER CONTRACT AGENT STATUS IF OFFSET CLAUSE APPLICABLE.

6. FORWARD HQS COPY ODENVY RESIGNATION ACTION SUBJ AND REASONS SUBJS RESIGNATION.

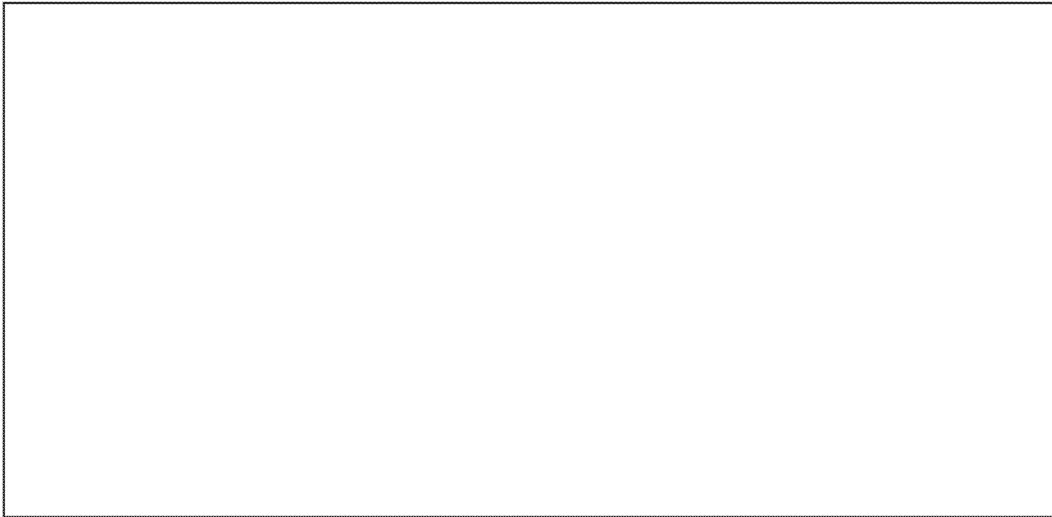

*All Comments Subject is George Munro

WII/Pers/ []

END OF MESSAGE

CPD/ []

Agent Panel/ []

D/IB/CS/ []

CI/OPS/ []

[]

C/aid

RELEASED OFFICER

SECRET

[]

AC/aid/3

AUTHENTICATING OFFICER

REPRODUCTION BY OTHER THAN THE ISSUING OFFICE IS PROHIBITED.

Copy No.