

21 Apr 89

~~SECRET~~/NOFORN

PROJECT SUN STREAK

WARNING NOTICE: INTELLIGENCE SOURCES AND METHODS INVOLVED

PROJECT NUMBER: 8914-I SESSION NUMBER: 1
DATE OF SESSION: 890420 DATE OF REPORT: 890421
START: 0940 END: 1045
METHODOLOGY: CRV VIEWER IDENTIFIER: 032

1. (S/NF/SK) MISSION: Describe the most unique aspect and function of the target site and provide an overhead sketch of the target area.
2. (S/NF/SK) VIEWER TASKING: Coordinates. Later 032 was given instructions to conduct a stage 6 exercise to sketch an overhead perspective of the site. He was also given the cue "most unique aspect and function of the site."
3. (S/NF/SK) COMMENTS: Next session will be spent obtaining more information on the most unique aspect and function and also developing a better overhead perspective.
4. EVALUATION:

HANDLE VIA SKEET CHANNELS ONLY
SPECIAL ACCESS REQUIRED

~~SECRET~~/NOFORN

CLASSIFIED BY: DIA (DT)
DECLASSIFY ON: OADR

This document is made available through the declassification efforts
and research of John Greenewald, Jr., creator of:

The Black Vault



The Black Vault is the largest online Freedom of Information Act (FOIA)
document clearinghouse in the world. The research efforts here are
responsible for the declassification of hundreds of thousands of pages
released by the U.S. Government & Military.

Discover the Truth at: <http://www.theblackvault.com>

WORKING PAPER

890420

IV: 012

S: 01

SUMMARY OF INFORMATION

Site is a man-made structure composed mainly of metal with elements of acrylic, plastic polymers and of hardened resins. There are several aspects to the site but the item that brought about the most significant level of interest in this session was that of a large, very powerful spinning object (see page 9). This object seems to be part of a larger or more complete aspect -- but during this session it became the center of attention.

Dimensional aspects associated with the site are curves, tubes, flat surfaces interfaced with curves, circles, discs, curving verticals and narrow light weight cylinders (see page 6,7). Textures and colors seem to be related mostly to smooth, silver, slick, glassy, white and the temperature seems to remain cold.

From overhead (see sketch page 10) in the first session I perceived that there were large objects or structures which had (principally to one side) a number of smaller objects or elevated areas. In the area from the overhead view I perceived that there were objects (things) rising and falling -- and at this time I began to feel very stressed and nervous about the enormous amount of activity at the site.

I also perceived there to be a black cloud moving on the horizon which blotted out the light source. There was another development in the rotating cylinders that appeared later in the session -- that was the enclosing of the space between the cylinders with some kind of clear material. This material looked like acrylic polymers and kind of looked like plastic (see sketch page 12).

The discs perceived seemed to rotate and bob alongside each other. There was something central to the disc -- it served as ballast, a balance point or guidance. There was a man lying down (all I could see was from the chest up) and he had a box on his head which was open at the face A/S like a helmet.

~~SECRET~~
HANDLE VIA SKEET CHANNELS ONLY

AV
PI - Yes/TIRED

032
20 APR 89
0945L

300652
870735

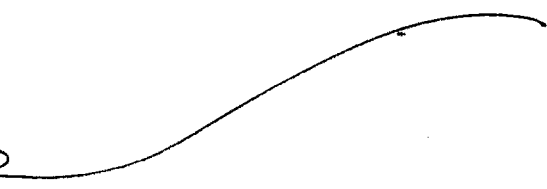

- A. RISING
OVER ACROSS.
HOLD MM
- B. Structure

SZ
Silver
white
Blue
Red
Black

300652
870735

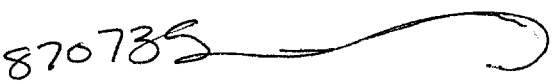

- A. Across
around door
under.
HOLD MM
- B. Structure

SZ

52
—
Silver
white
Red
Orange
Smooth

hms.
holes
Bumps
Ridges
Rough
Stitch
Rattling sound
wired sound
austling sound

300652

878735 -

A. across flat
hard arm
B. structure

53

obus
circles
smooth lines
flat
Horizontal
Arched.
Vertical
Slanted
Narrow
right
,

4

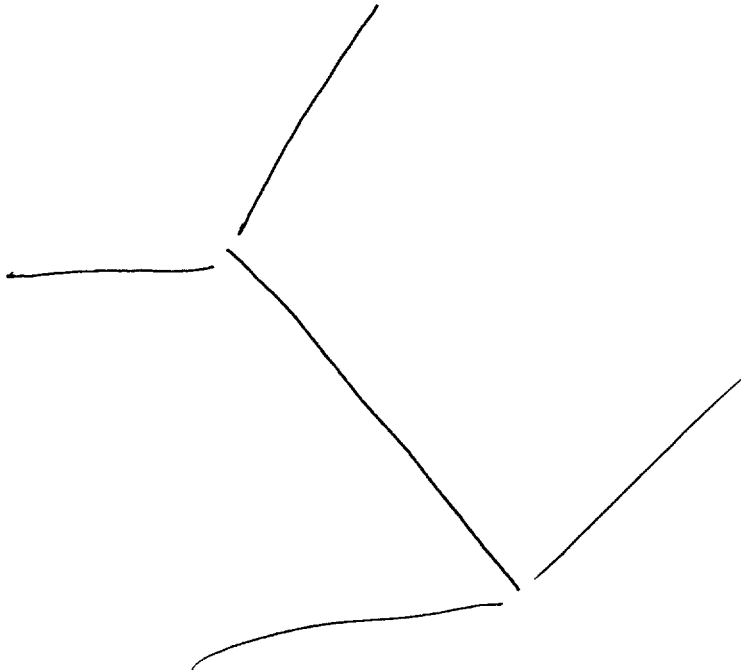

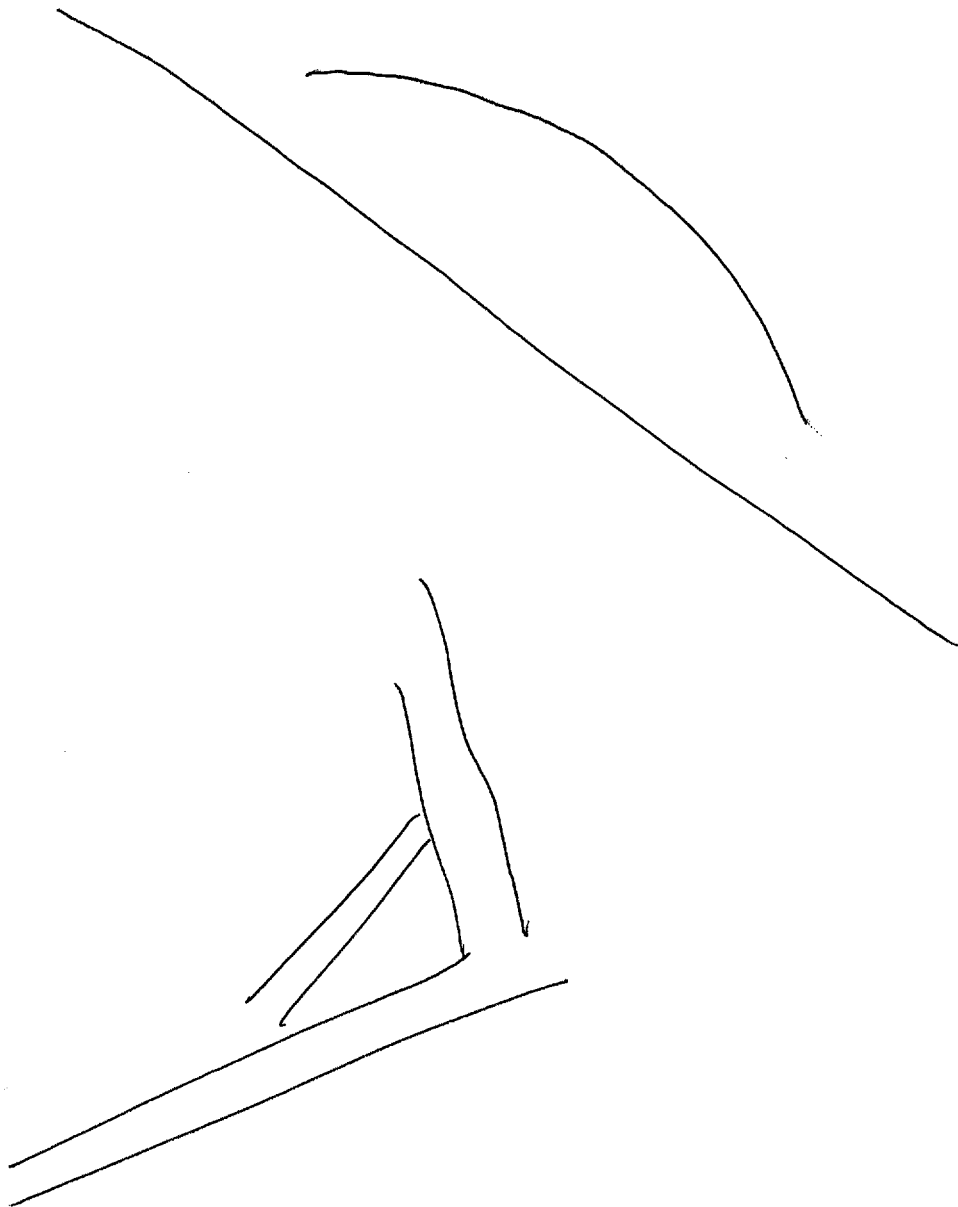

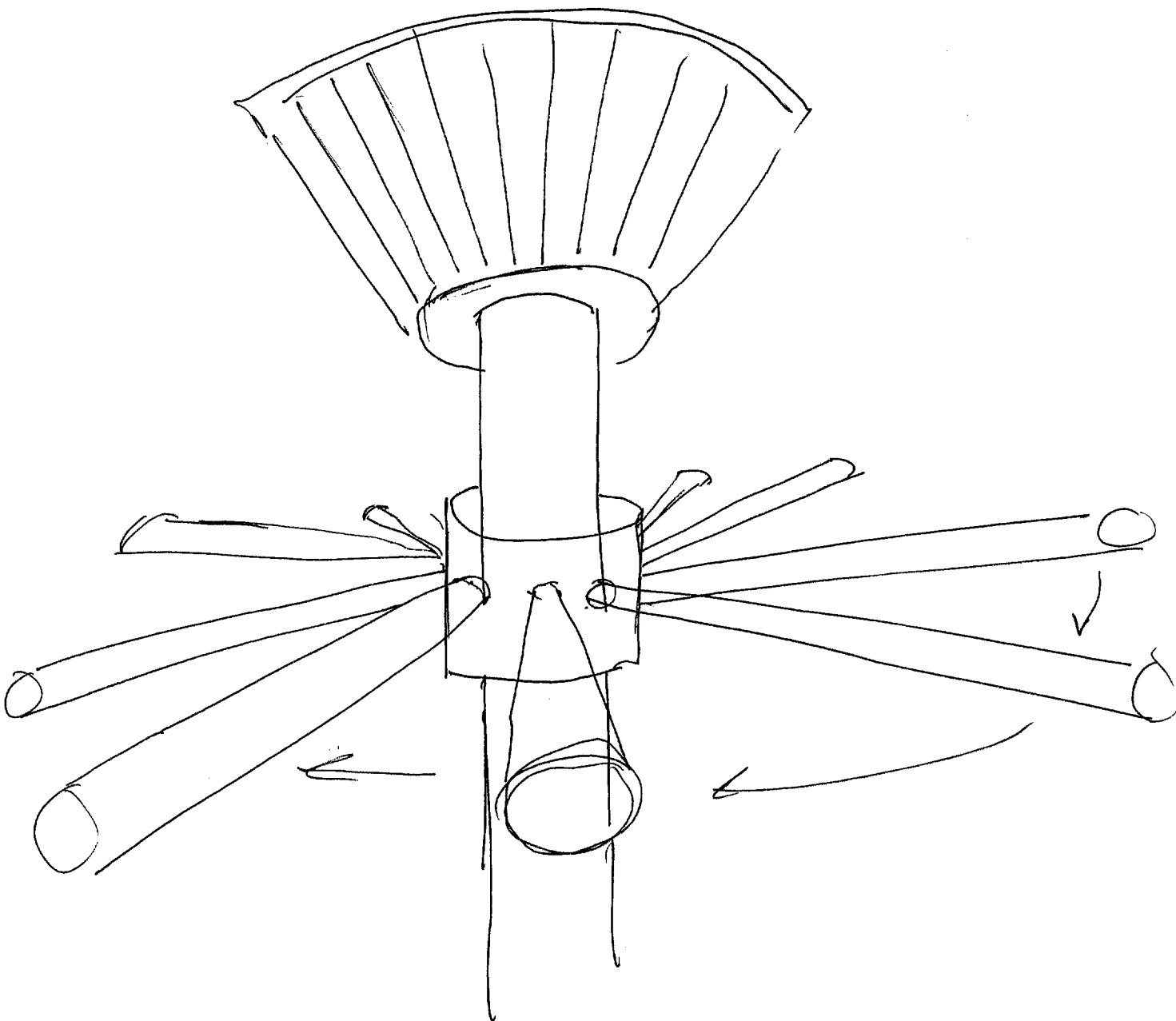

OVER HEAD
1000' - 1500'

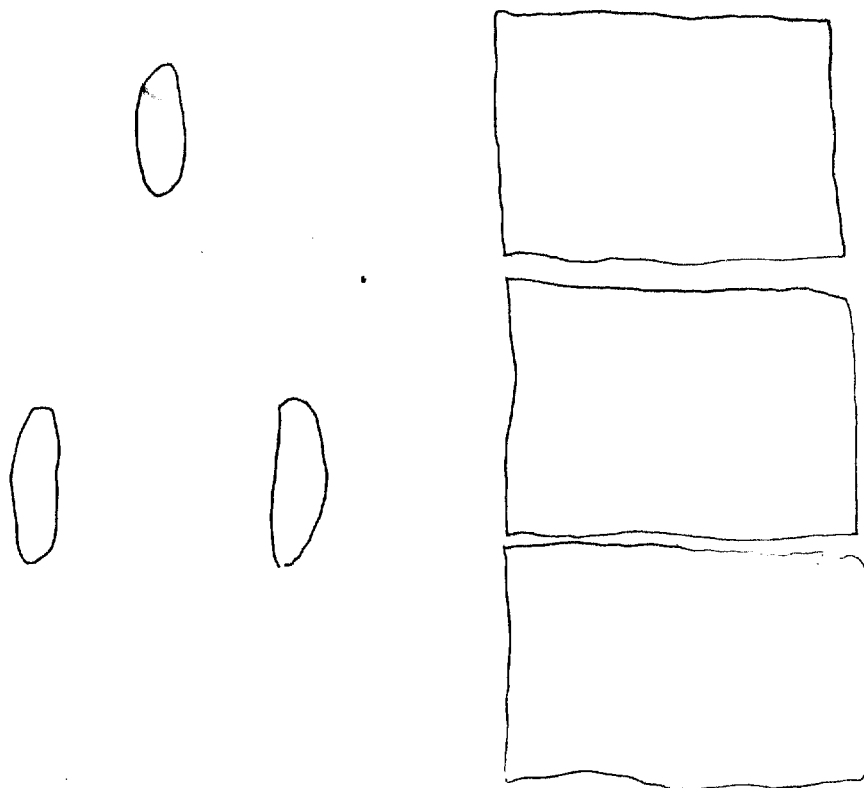

AC/AS 10,
AC Break
This is
wild,
Break.
1005
HOL AMM
Park

Sprawl
Borren

metal
concrete

activity

movement
stationary

OBJECTS

Buildings

cornels
long
large

rising
falling

noisy
Busy
noisy

1/2 - lots of activity, external noise, far reaching
EAR shattering

AT Break.

This place makes me nervous - stressed
feeling too much going on. Feels like
there is the way of something.

52

D

AI

EI

T

I

AOL/ps

[MOST UNIQUE ASPECT/FUNCTION]

Orange
Blue
with-

AOL Bunk
Instruments
Panel.

4 1/2 - spinning, constant rotation, power, energy, gyroscopic, very unique powerful object. I keep seen and focusing on this particular sector - I's A/s with the help of Rotary wing A/L.

[function]

4 1/2 - Black wave (cloud like) rolling across space or sky - blotting out the light. Object spinning much more slowly now. All quite webbed or enclosed staves cylinders - clear - acrylic plymers - resin, hard.

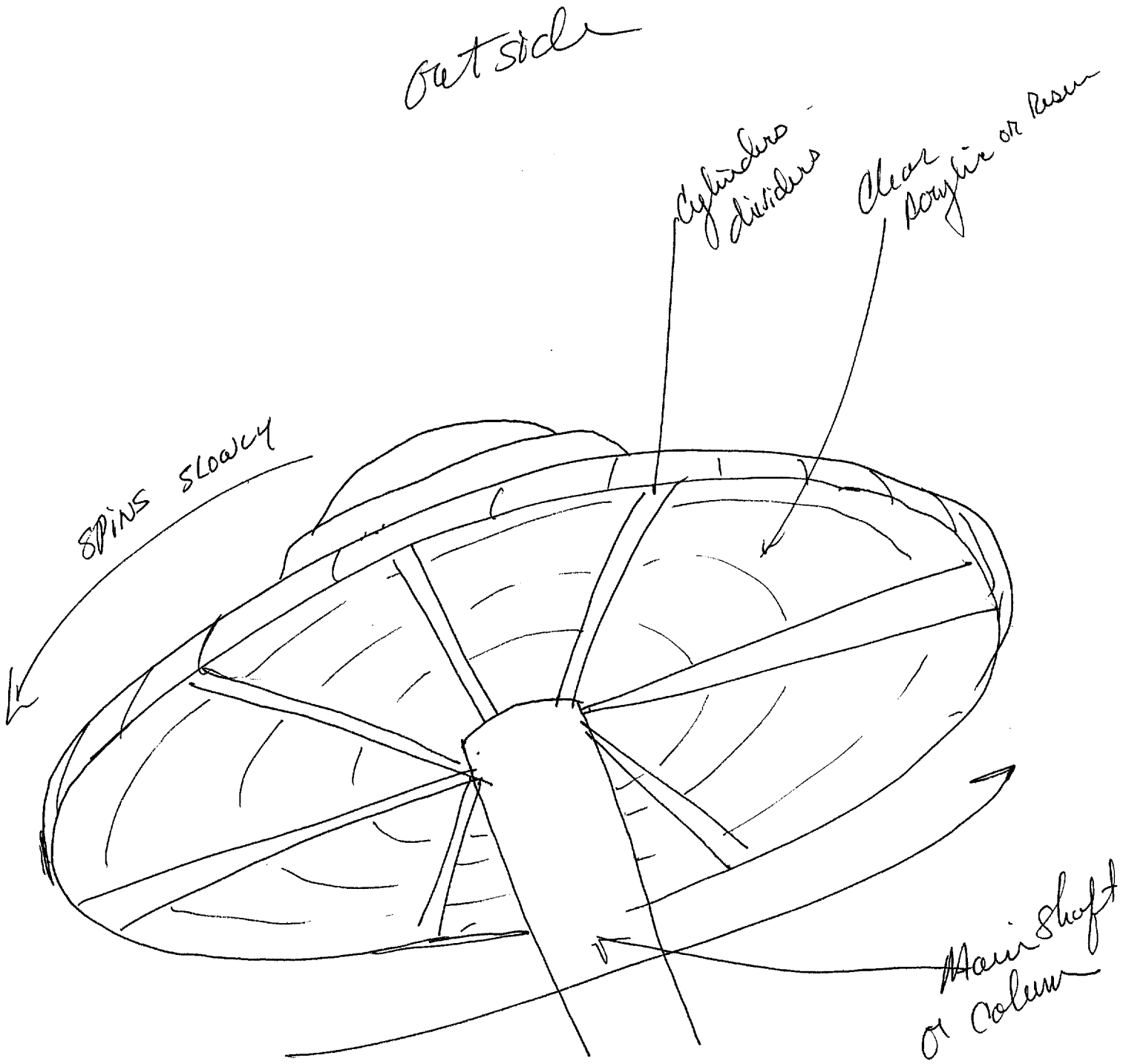

STAGE C

SZ

D

AI

EI

T

I

ADL/AS.

Bobiny

4/2 - chocs bobiny stonsich stach ofve moving
 away from me. Southing central
 narurev - ballast to the diae.
 fulceum, balace point, guidance
 Mants chest and head -- box on
 his head - hying down - face to
 box is open - A/S helmet.

End.
 1095