

B
101

099

21 Apr 04
ST 09 end 1010

TI: Beautiful Day

Bill

Monitor: Ed

21 0904 Apr 86

FT Meade, Md.

143850.2

491920.8

A across
hard

B LAND

A UP
TITR4
UP
ANGLE
ACROSS
HARD

B STRUCTURE.

S2
BROWN
GRAY
COOL

This document is made available through the declassification efforts
and research of John Greenewald, Jr., creator of:

The Black Vault



The Black Vault is the largest online Freedom of Information Act (FOIA)
document clearinghouse in the world. The research efforts here are
responsible for the declassification of hundreds of thousands of pages
released by the U.S. Government & Military.

Discover the Truth at: <http://www.theblackvault.com>

BROWN
GRAY
BLACK
TAN

ROUGH
GRAVELLY
COOL
SMOOTH

SWEET SMELL
MUSKY SMELL
IRRITATING SMELL

DAMP TASTE
LOAMY TASTE

AOL BREAK
LIKE A
SOOTY TASTE

CHUNK - CHUNK
KA-LAP
FRICTION/SLIDING SOUND

COOL
CLEAR
DAMP

CLEAR
GREEN
DARK

LARGE
HIGH
LOW
AROUND
THICK

BORDERED S-4

AI BREAK
INTERESTED,
EXCITED,
ANXIOUS.
GOOSE BUMPS
ON LEGS

HIGH
TAIL
NARROW
LONG
THICK

AI BREAK
very interested
very much
in a hurry.

WIDE
AROUND
LONG
HIGH

Around
wide
Rolling
open
ENCLOSED

AT 3RE
I FEEL ISOLATED
ALONG, THIS IS
NOT UNPLEASANT

↙

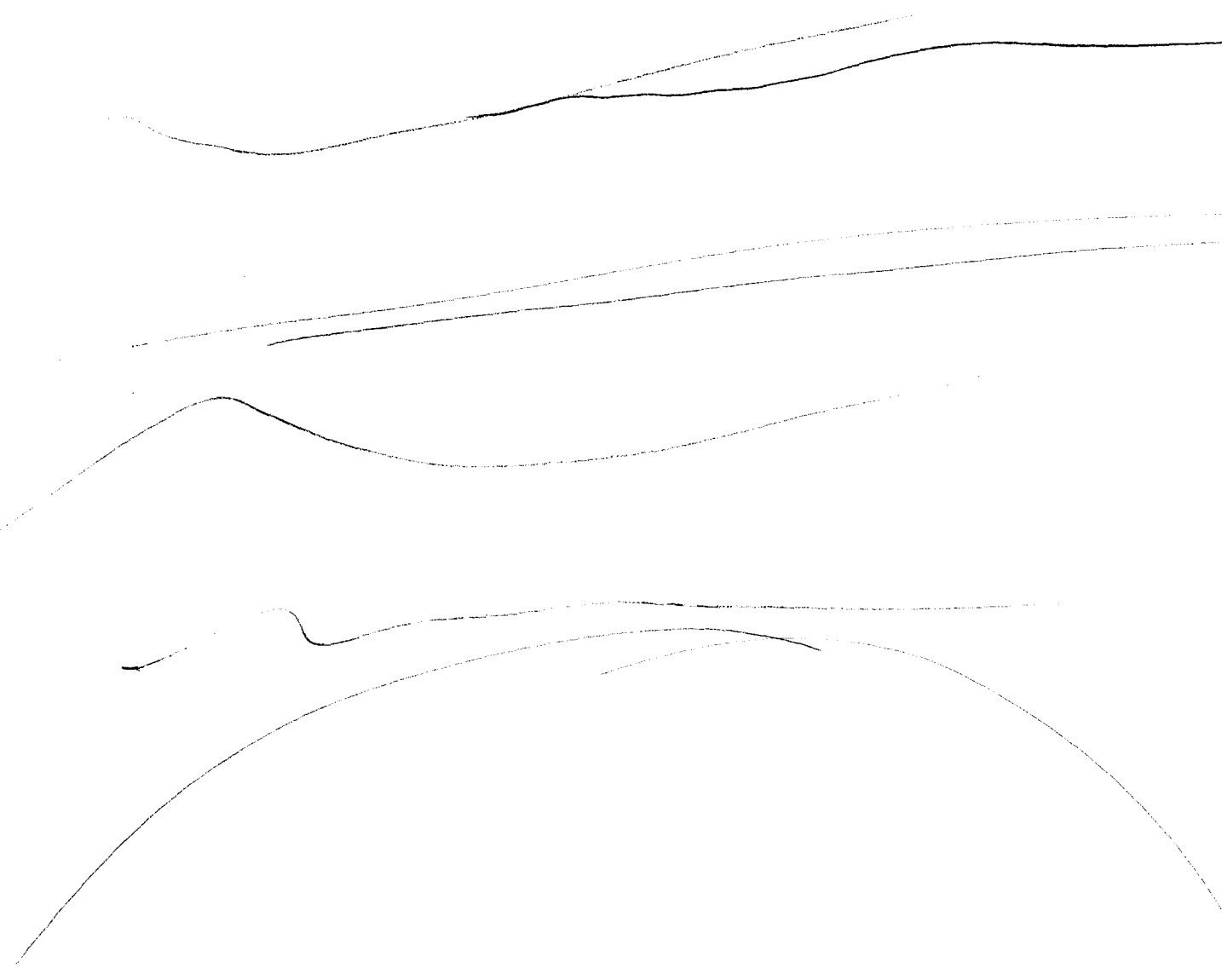

SK



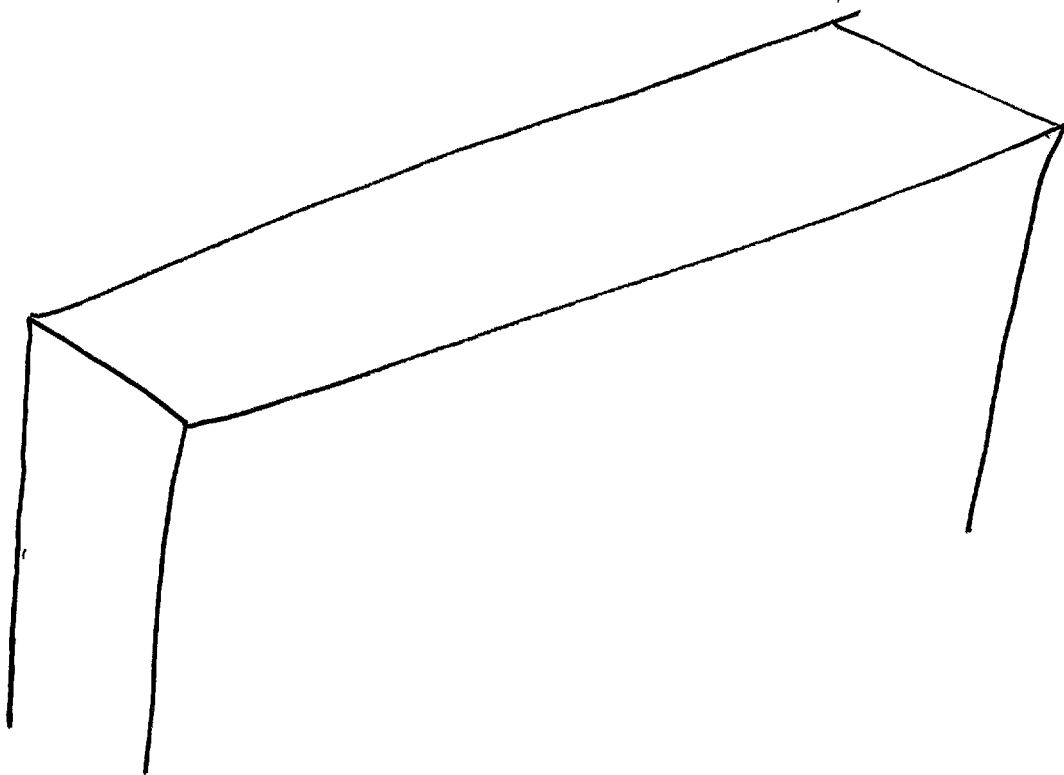
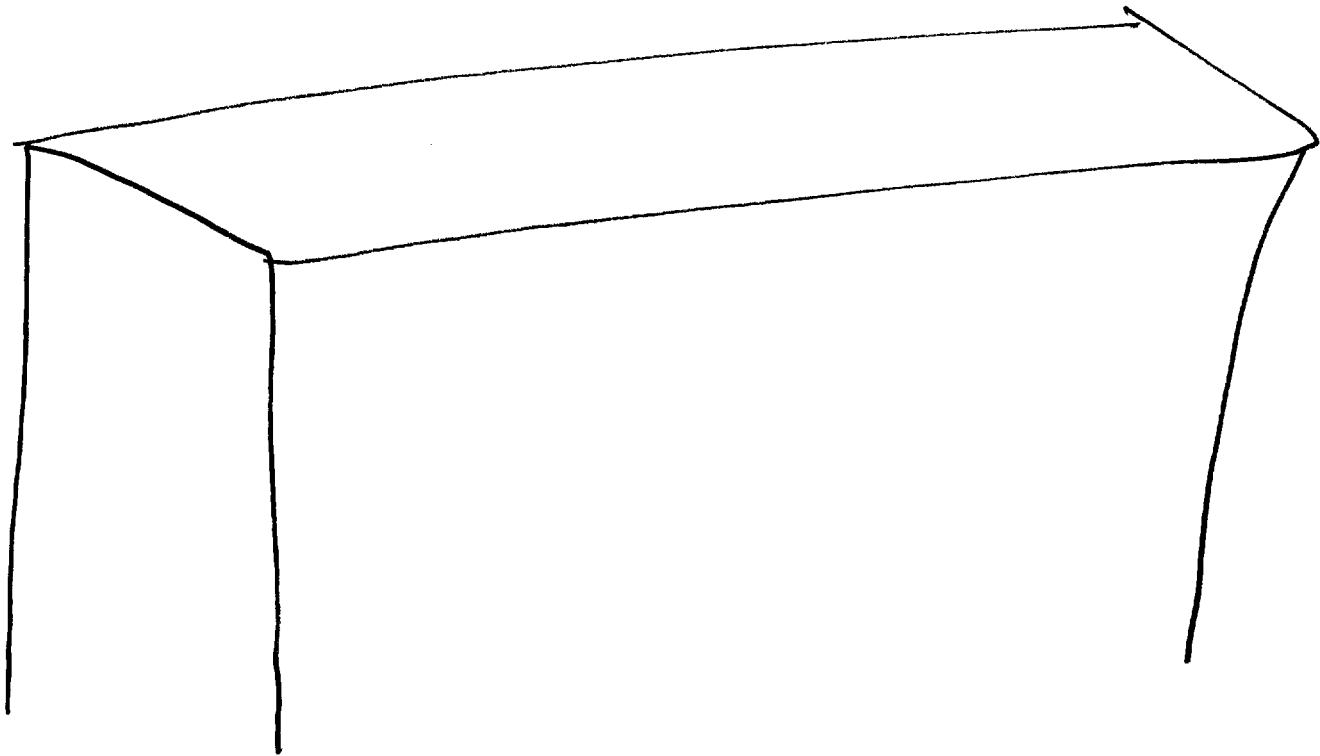

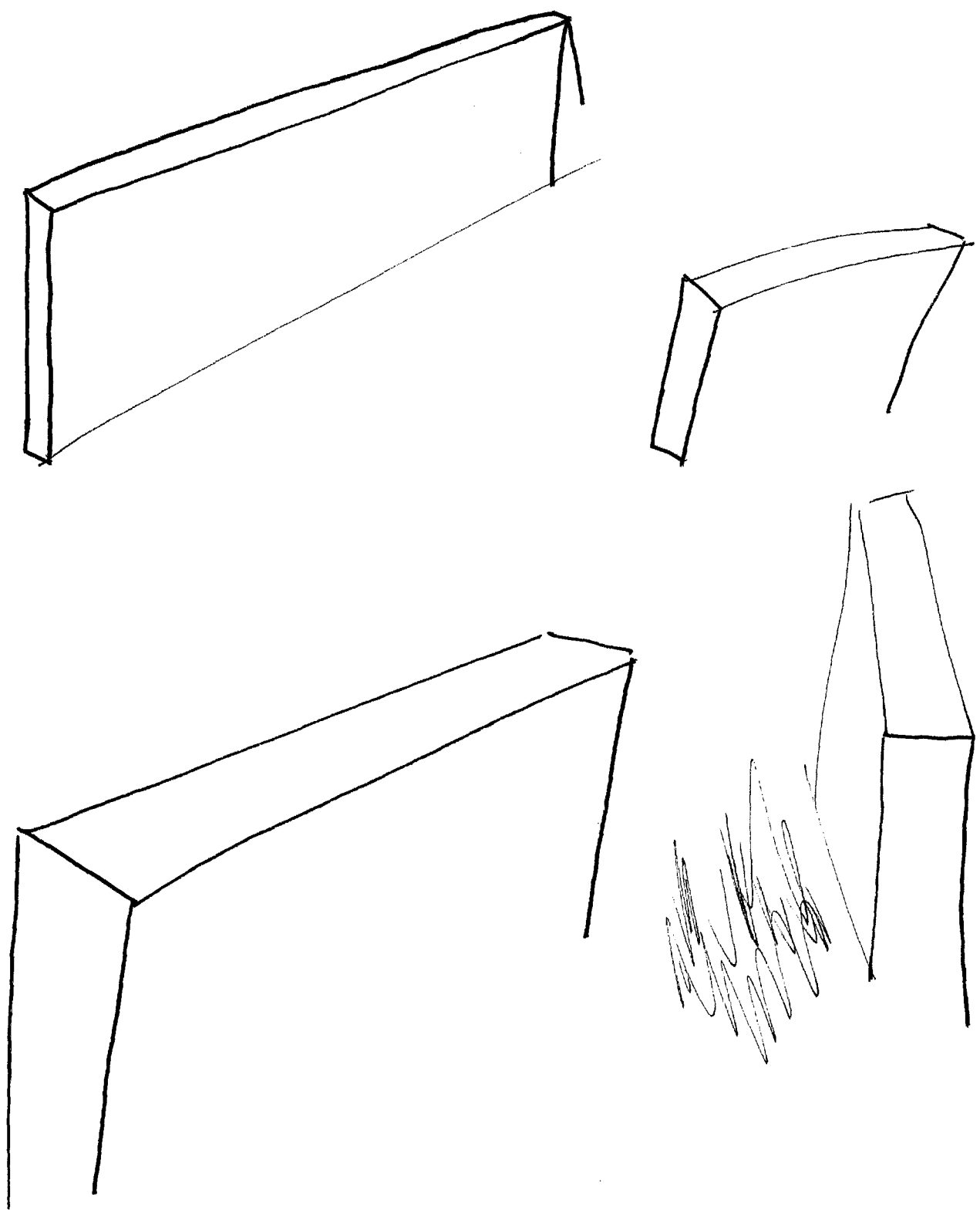

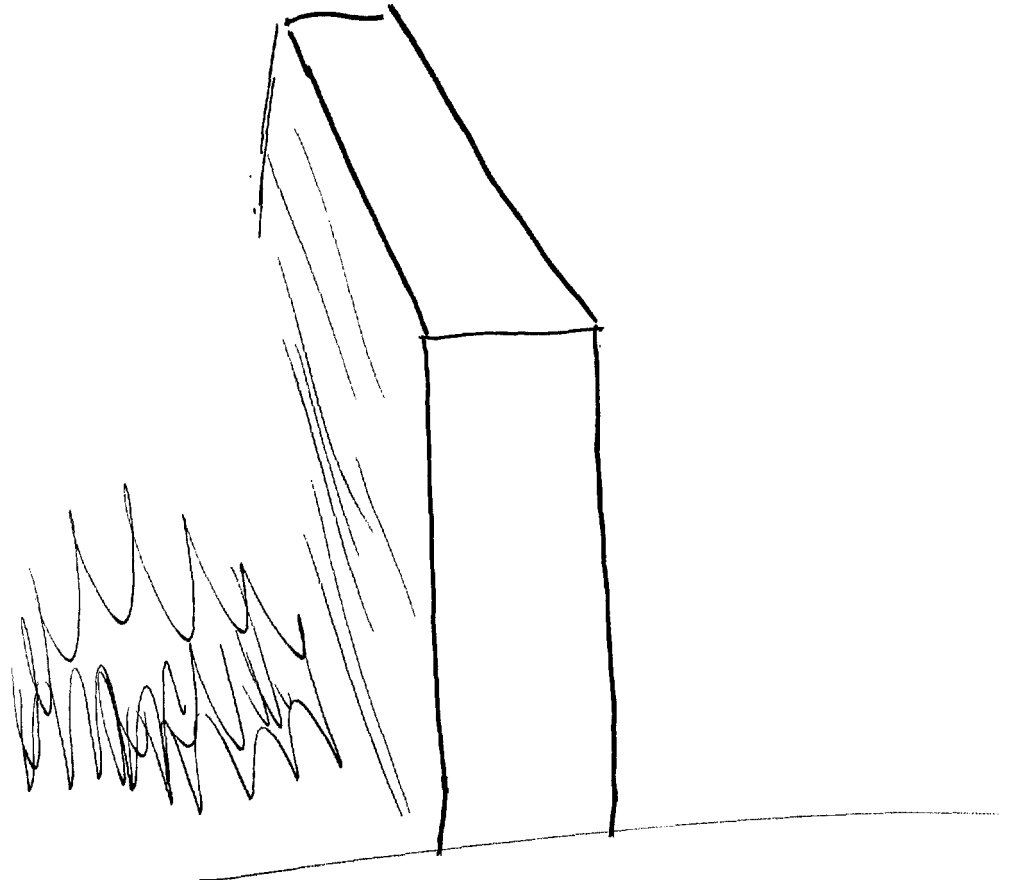
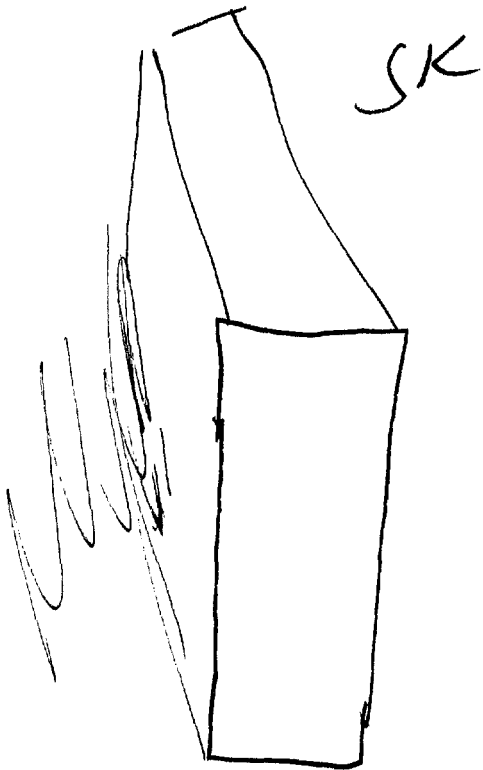

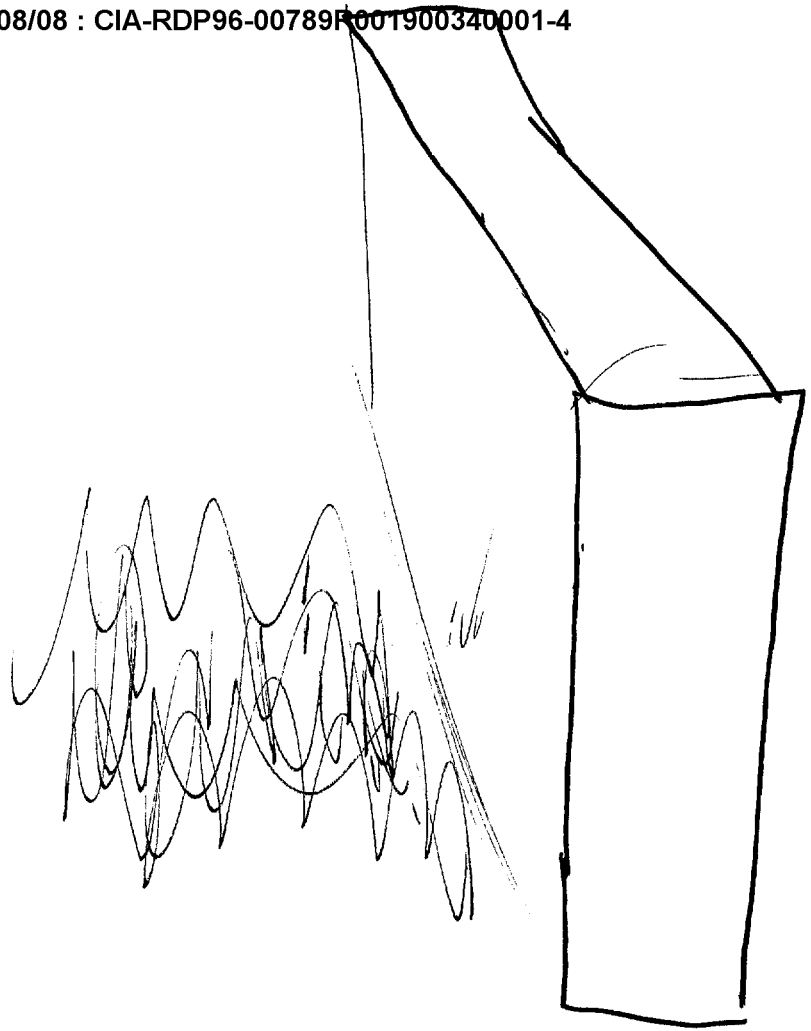

BLDG
-B

SK

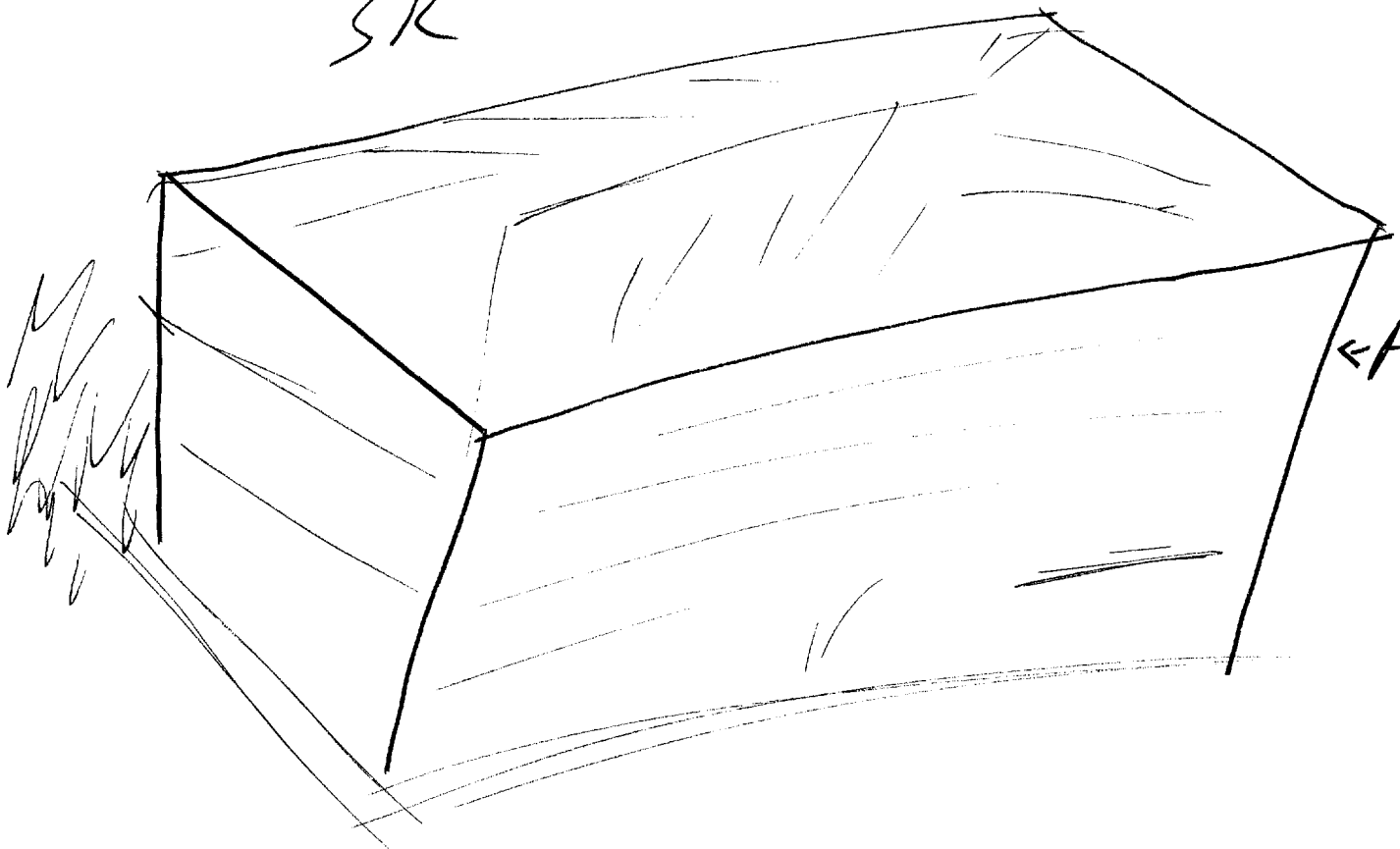

BLDG
<A

SUMMARY: Site is located on flat and rolling land. Area makes me feel alone, isolated cut off. This is not unpleasant. There are a series of structures at site. Two of these structures are described below. One is tall, High, long and narrow. The second structure is wide, around, long and high. 12

TO K east something
should be
visible



A up across
down
hard
B HAVE

10 K east something
should be
visible

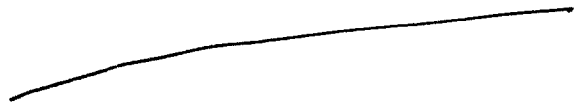

A across
hard
MAN MADE
B STRUCTURE

A ACROSS
HARD
MAN MADE

A across
hard
B LAND.

20 K S/E something
should be
usable

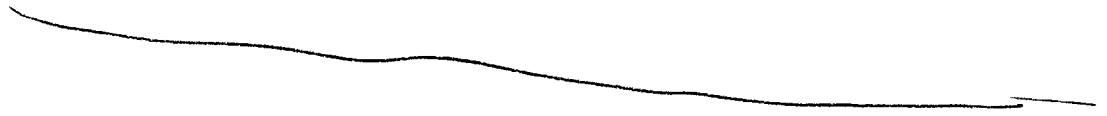

MISSED BREAK

AV water.

20 K ^{5/2} something
should be
visible



A up/across
angle down
hard
B structure

20K se something
should be
visible



MISSED
BRICK
MISSED
feeling

A many
blues
B water

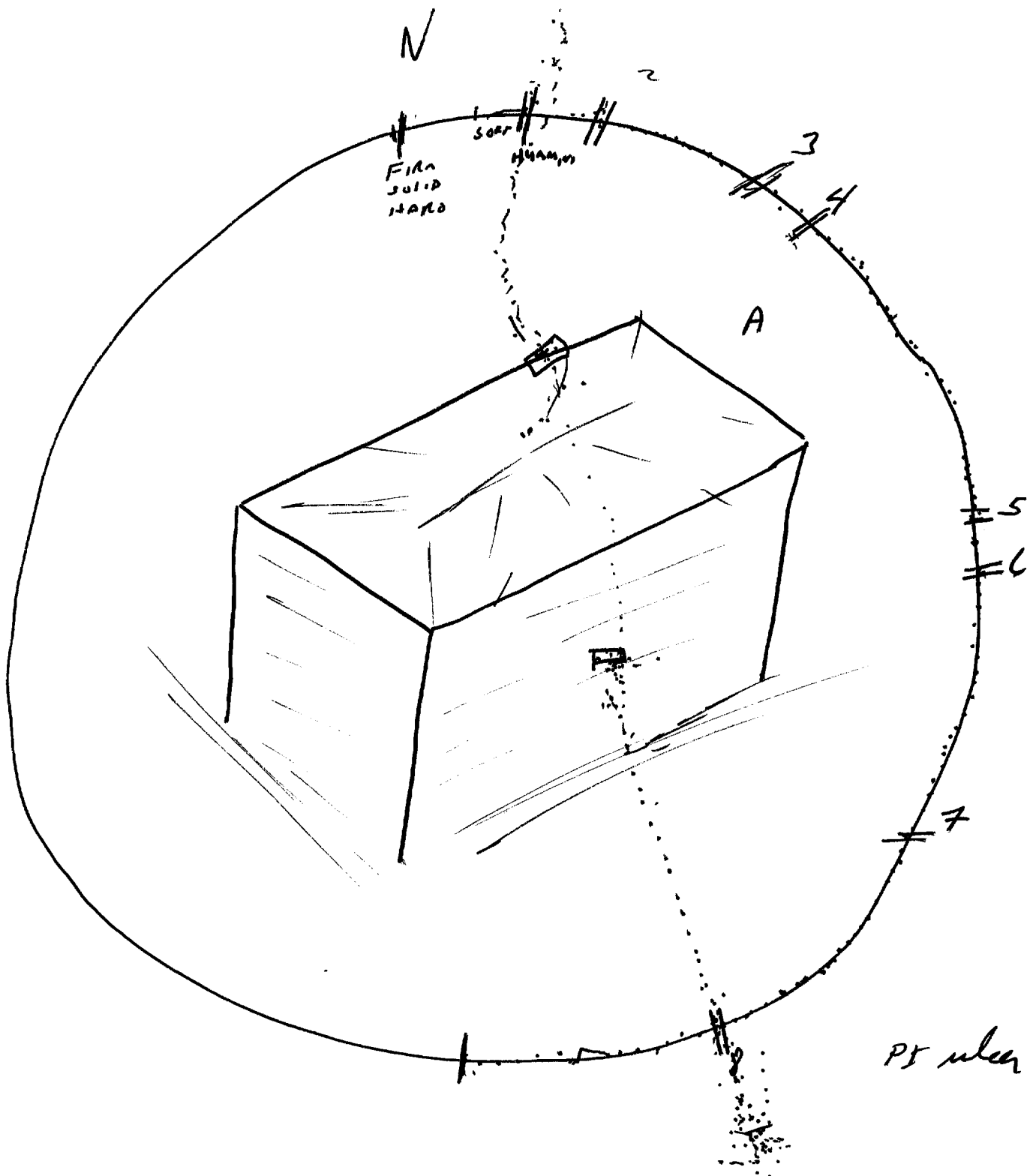

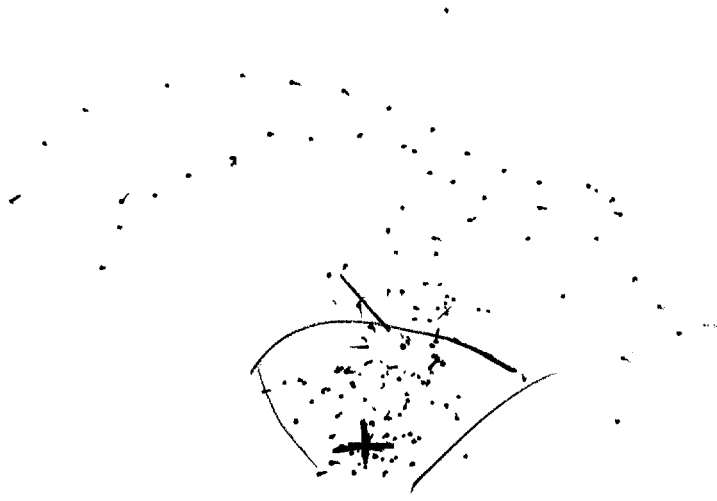

GOING
NT

5.2

17

AOL A/S

Drugging
entire
static

OPTION closed
OPTION

AOL BANK
WIRES
CABLES

2

HARD
REMOVE ALARM
FIRE

ELEVATED

DARK
BLACK

THRESHOLD

3

MOVEMENT
ACTIVITY

HUSTLE
coming +

coming
+
going

4
QUIET

OPEN

GAP
SLYd6c

AS BLEND
NEARBY
THICK FEELING
IN TUNNEL
AT BREAK
NASTY

6
WARM

FLUID
~~FLUID~~
MOVING
SHIFTING

7
STINK

AS small
yuck

8
Humming

wave
SK energetic

VOICES

SZ

19
A61 ALS

GREEN

HUMMING

ALYU

ROYAL

LONG
NARROW

ENCLOSED
VALID
CONSTRAWED
SYSTEMATIC
LINKED

BUTTONED
BALLONED

BROAD
TAPER

SILVER
BLACK
SHINY
SMOOTH

ENCASED
SEPERATED

A MILLING
A ROUND
FEELING

BOUNCING
BACK + FEELING
FEELING

SEPERATED/
SECLUDED/

TREMBLING
STRUCTURAL
METAL
HOUSED

SOUTH

LIKE JAGGED
IN A WAY

OPEN

DISPATCH

TEMPORARY
difuses
AOL DREAT
Temporary

LIKE A SHIP
IN SPECTRUM

WEAKENS

DIFFERENT
FROM NORTH

North it bounces out thru
in South it just dissipates.

FEELING THAT MOLECULES
JUST SLOWLY ~~CEASE~~ CEASE
BOUNCING OFF ONE ANOTHER

N

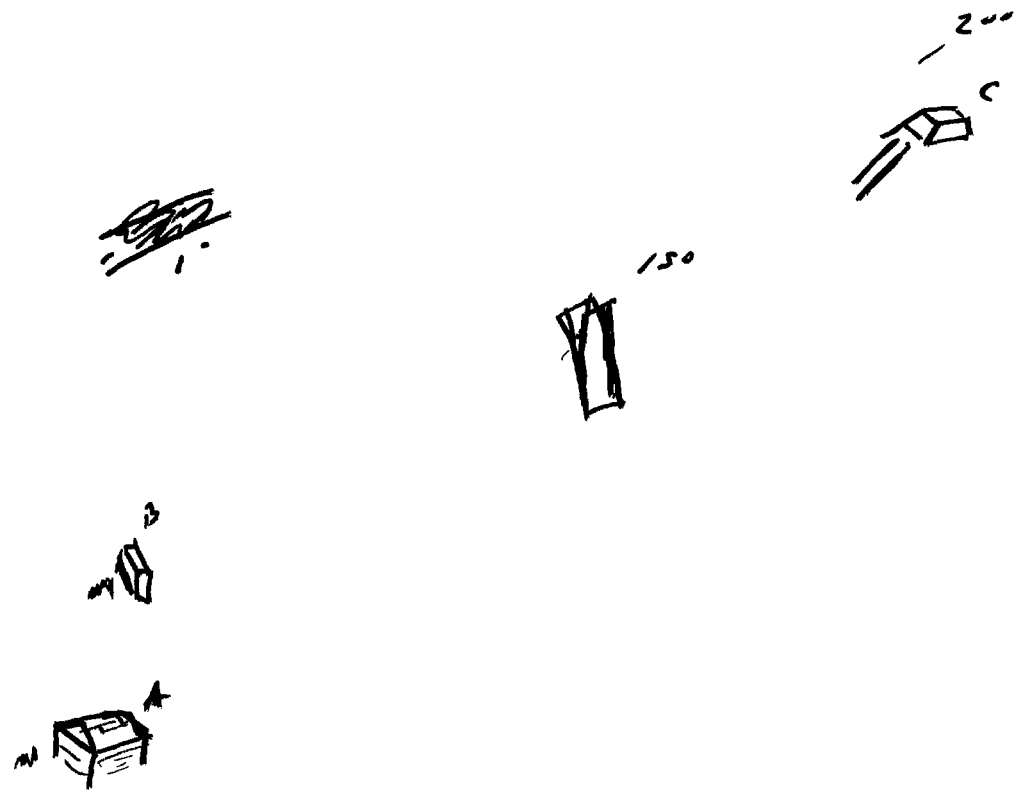

NE something
should be visible

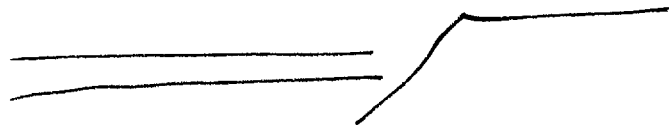

A running
along
hard
man made

B structure

A sloping up
angle
across
Man made

B structure

From A 150 M
NE something
should be
visible

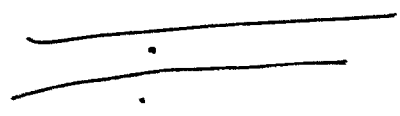

A hard
running along
man made

B structure

A across
flat

B LAND

A across
flat
hard

B land

From A 200 M
N/E something
should be
visible

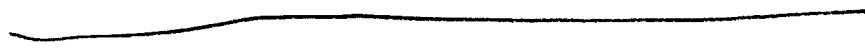

A across
soft
B land

From A 200 M
N/E something
should be
visible

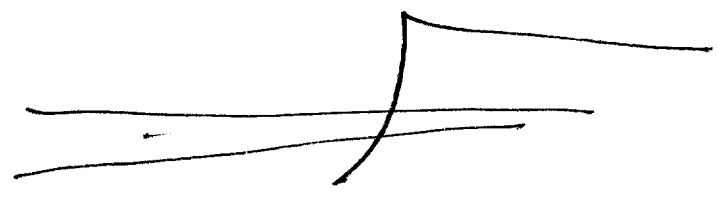

A running
along
hard
Man made

B structure

A curving up
high
across
B structure

52

BROW
PAIK
smooth
enclined 5-4

LOW
LONG
NARROW
FLAT

As Bank
getting water

NARROW
THICK
RUNING
LONG
LARG.
wide

As Bank
water

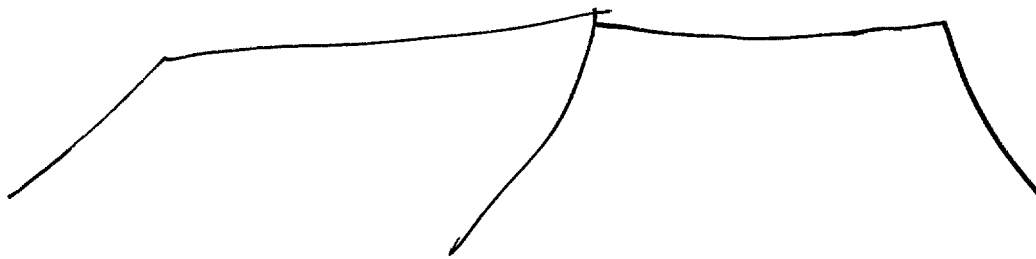

JK BLK
 C



INSIDE C
Should be

AV. part open
structure

inside structure C
something should
be perceivable

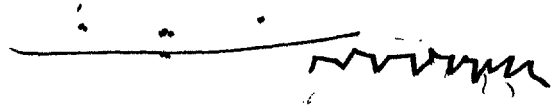

A decors
hard
flat
man mad

B struc

A up down
up down
hard f
B structure

A up down
up down
energetic

B —

S 2
Yellow
TAN
WHITE

WARM
CLEAR

HISS
CLACKLE
SHHOOC
SHU - LINK

open
Bounded S-4
Bounded - S-4

LOW
NARROW

AOL Break
Flax & linen

HEAVY
NARROW

AI Break
leery feeling,
want to
look over
my shoulder.

S.2

AOL

28
ALS

STRUCTURE

LARGE
WIDE

Brown

STORIED

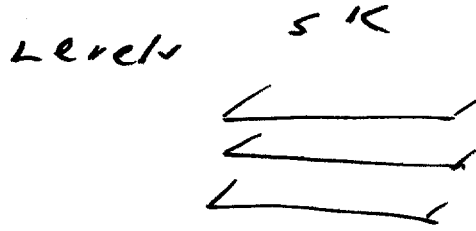

secured
separated

People

SHIFT

SUBTLE
CLANDESTINE

CALLOW
BUZY
AMBITION
INQUIRING
KNOWING

DUPLICATION
RE-DOING
ADMINISTRATORS
ENFORCERS
MECHANICS

S2
D
Yellow
WHITE
BRIGHT

CHANNELS
MONITORED
IMPROVED

AOL BREAK
COILS

FAINTER

LEVER SK



WALL

MONITOR

DIALS

SK
⊕ ⊖ ⊕

GLASS PANEL

LIKE AN
ISOLATION
BOOTH



Feeling like gets
wetter as approaches
building.

MONITOR

OBJECTS
EMANATIONS?

- PANELS
- WIRES
- LIGHTS
- PEOPLE
- WHITE COATS
- YELLOW HAND HATS

MONITOR
ATTRIBUTES
EMANATIONS?

- DESIRE
- SCALES
- INTEREST
- ALERTNESS
- ON-GOING
- DEVELOPING
- CHANGING
- SWITCHING.

MONITOR
SUBJECTS
EMANATIONS?

RESEARCH
PROOF

MONITOR
TOPICS
EMANATIONS ?

AOL BREAK
SUB-ATOMIC

MONITOR
TOPICS
EMANATIONS ?

WHITE
COLORS
DIVERGENCE
Feedbck

MONITOR
TOPICS
EMANATIONS ?

SYNESTHIC
PARALLELS
PROMPTNESS
PERDICIBILITY

stronger as approaches
building A.
inside bldg A. it
changes.

There is some link
between two boxes

S2

33
A/S

SHUTTLE SL



CONCRETE

INClosed

LOCKED

LIT.
BRIGHT

GUARDED

LIKE A
BACK DOOR

STRENGTHENS

C Act Break
CONTROL

N

C
177
200

150
m

0
177

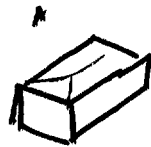

20K S/E
↓
WATER

SUMMARY

Approved For Release 2000/08/08 : CIA-RDP96-00789R001900340001-4

Site is a collection of buildings which together compose some kind of a whole. Land is flat and rolling. Site has a cut off, isolated feeling 20 K to SE is a body of water.

One building is large, wide, and tall. I will call this building A. On the northern side of this building there is some kind of energy. Energy goes out or comes in a northern direction where it ends in a fan shape

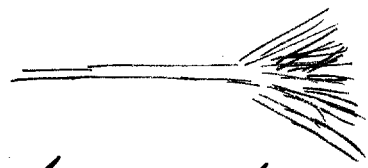

There is a similar energetic feeling on the south side. But the energy is somewhat weaker. The energy just seems to dissipate some distance from the building. It is like the molecules just gradually stopped bouncing off each other. There two types of energy (or whatever) end or begin at different spots within building A. The spots within the building where the energy is connected. are interconnected by another kind of energy.

Approved For Release 2000/08/08 : CIA-RDP96-00789R001900340001-4

There is a feeling of

Developing and monitoring ^{panels} this building. There are desks, lights, and levers. People work shift work. There are different categories of people here. Some of these categories are administrators, enforcers and mechanics. There is a feeling of subterfuge and clandestine here. There are different levels here. Levels are separated and secured.

North or North/East of building A is building B TALL, NARROW AND LONG. (NFI) 200 meters N/E of building A is building C. building C is low, long, wide, thick.

Inside building C is warm. There are crackles, HUs and a SHG-link and a SH0000 sound either. Inside building C I feel I should keep looking over my shoulder.

General feelings for what they are worth

1. There is a feeling of not a lot of originality here. It is as if they are duplicating or re-doing something. A feeling here of a lot of Ts and no Ps.