

u/I object

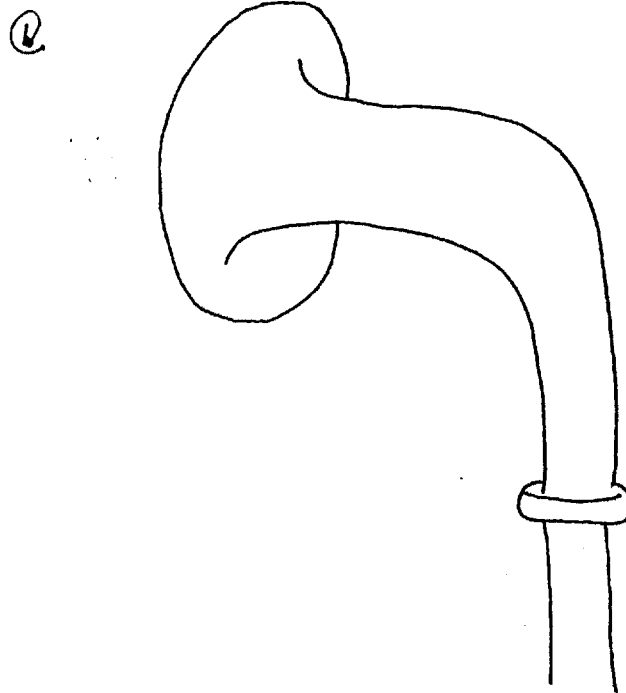

u/I object

079-1

This document is made available through the declassification efforts  
and research of John Greenewald, Jr., creator of:

# The Black Vault



The Black Vault is the largest online Freedom of Information Act (FOIA)  
document clearinghouse in the world. The research efforts here are  
responsible for the declassification of hundreds of thousands of pages  
released by the U.S. Government & Military.

**Discover the Truth** at: <http://www.theblackvault.com>

ⓐ

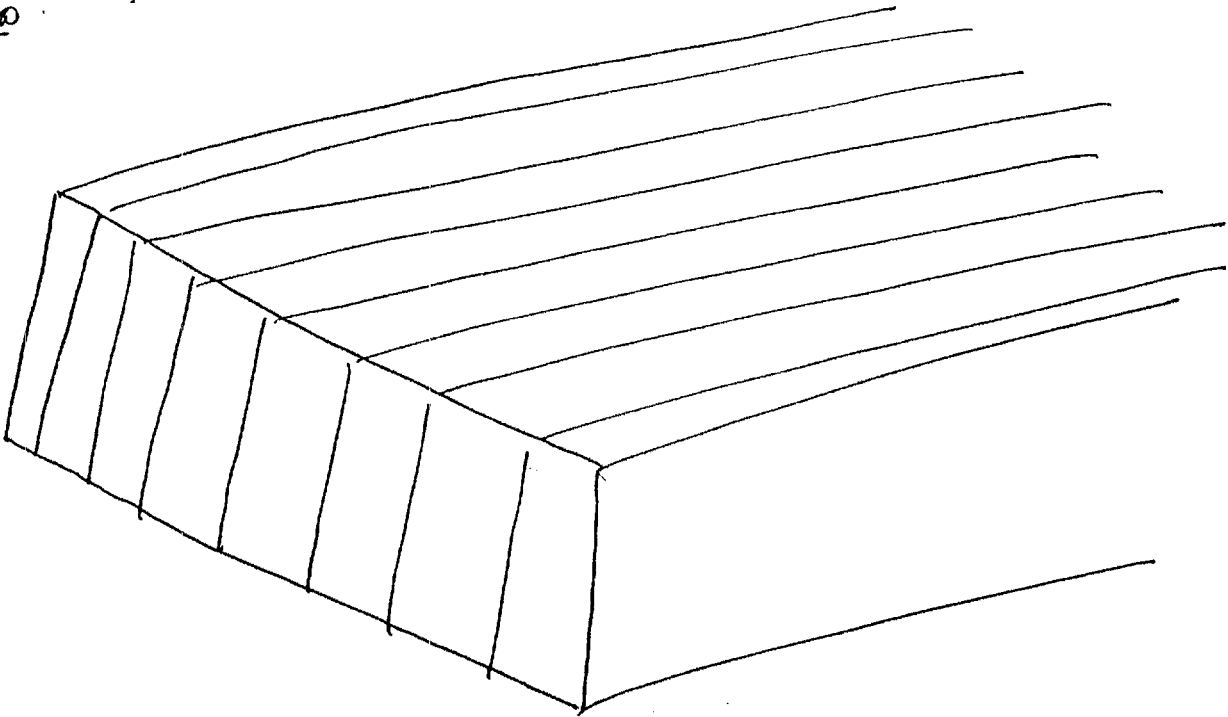

1/1 object

ⓑ

\* some sort of "flap"  
 that flips out from  
 main body of  
 larger object

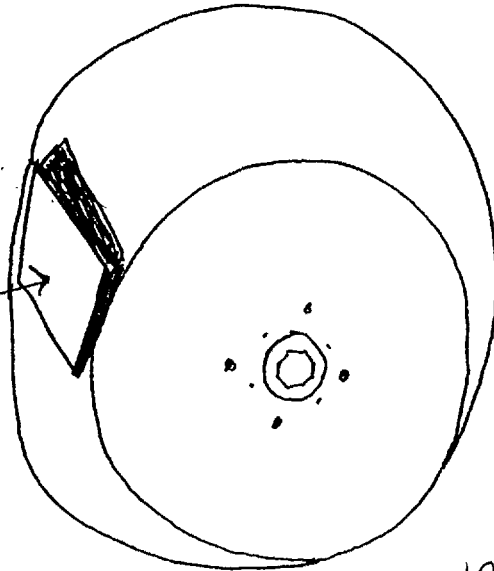

\* slowly turning; "flap" like  
 feature used for passing of  
 something, either into, or  
 out of, circular object.

079-2

(a)

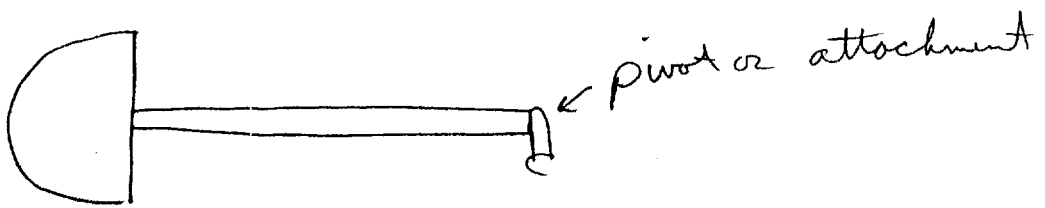

v/I object which slowly moves back  
; forth in a fan-like motion

(b)

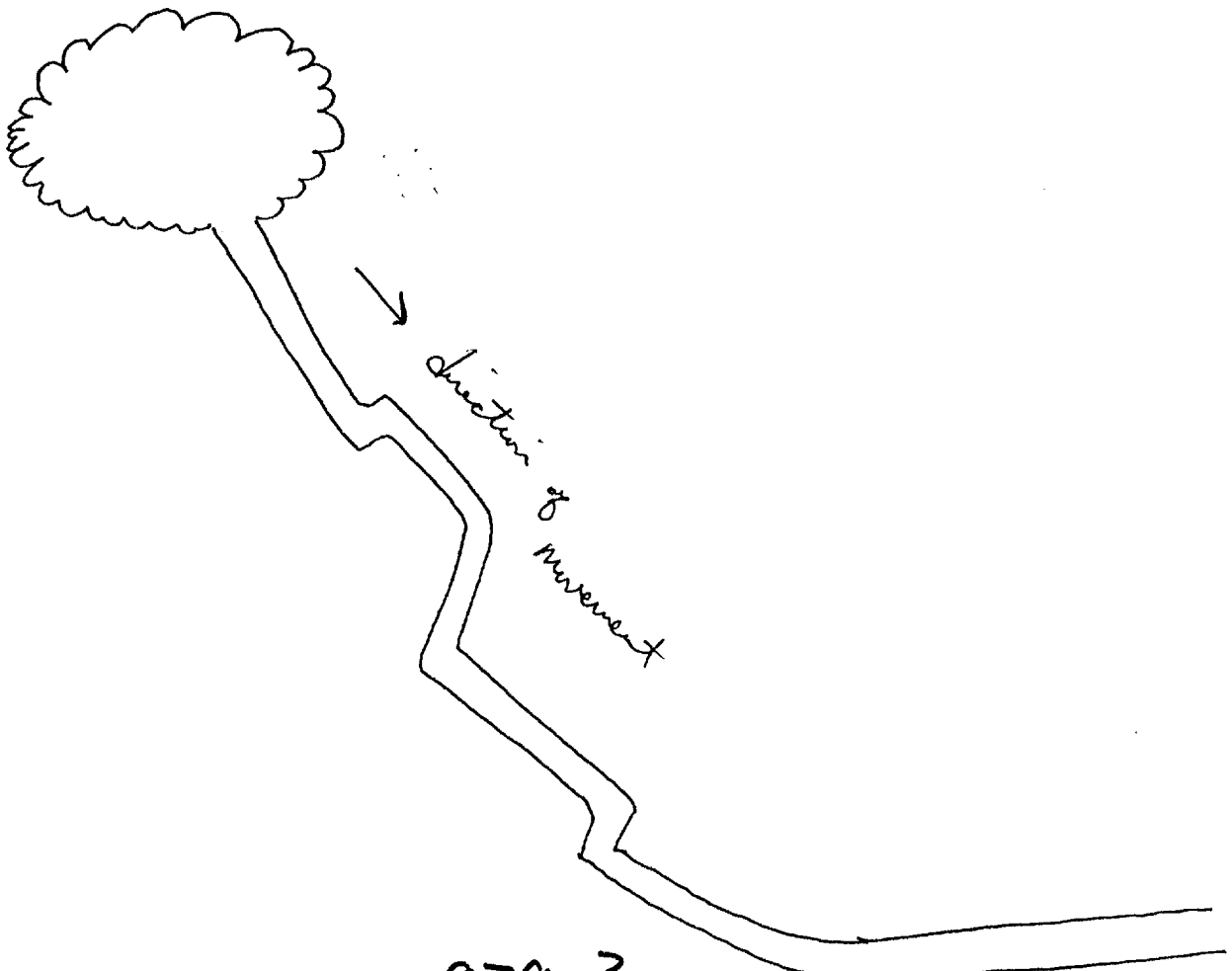

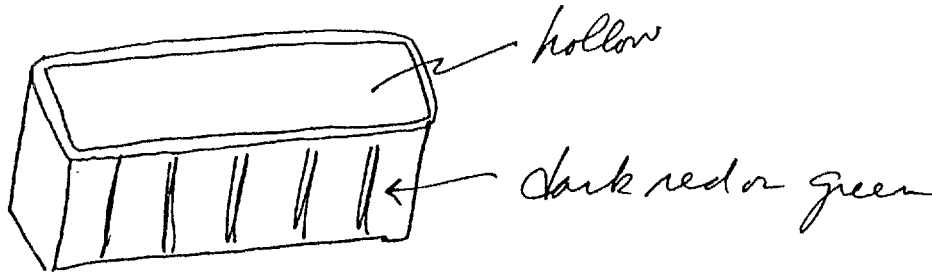

U/I object

(B)

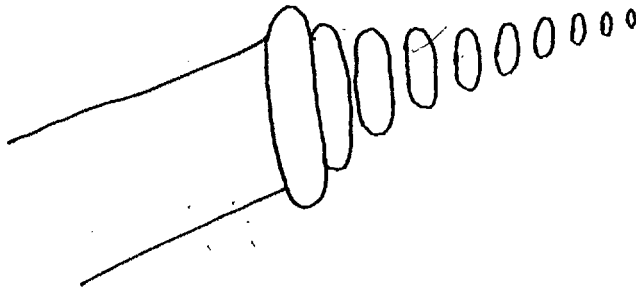

U/I object associated with pulsations  $\rightarrow$  high energy

079-4

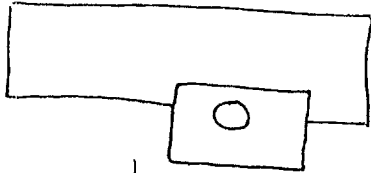

\* overhead view

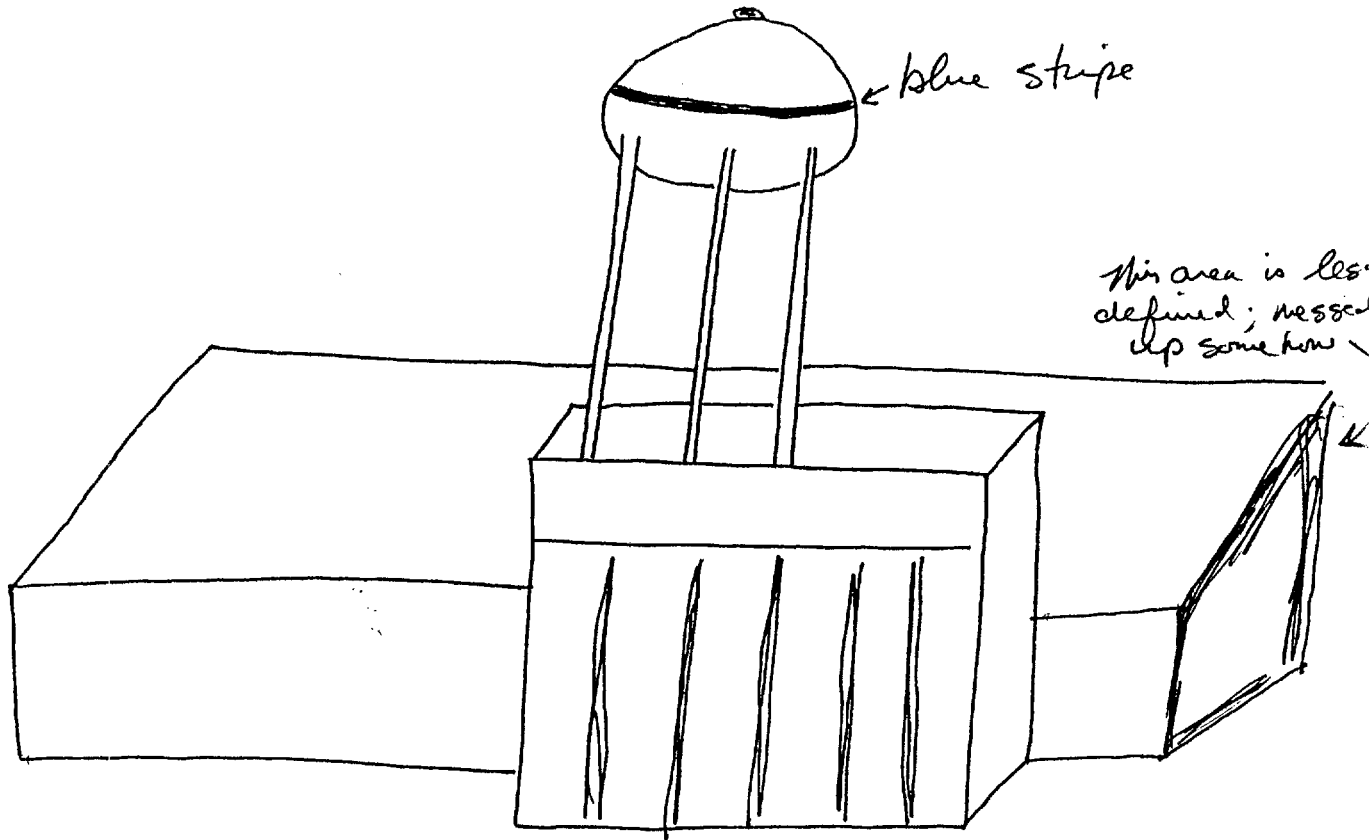

\* side view

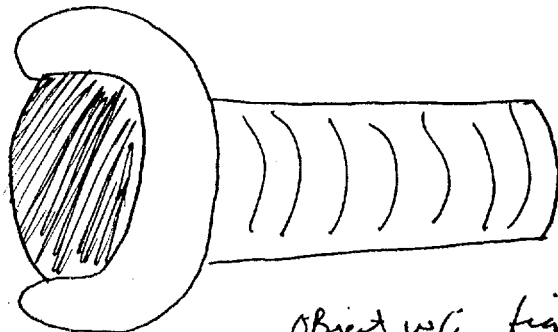

Object w/o figure above; hollow, large, rounded end at "opening"; spinning.

079-5

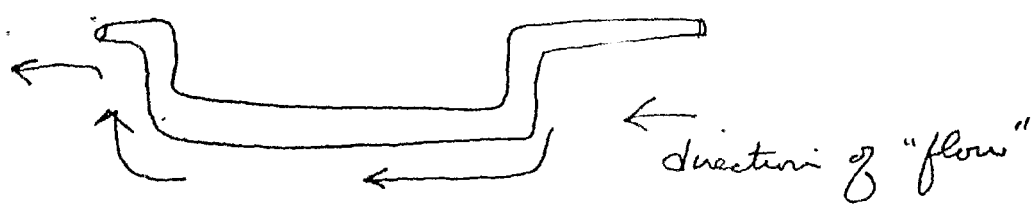

direction of "flow"

(b)

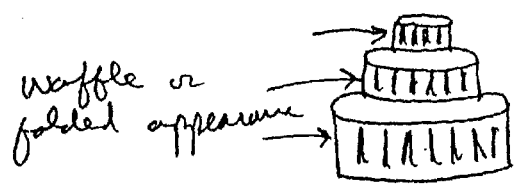

waffle or folded appearance

Series of concentric - sized air-filter looking, objects sitting on top of one another; spinning, at different speeds relative to each other

(c)

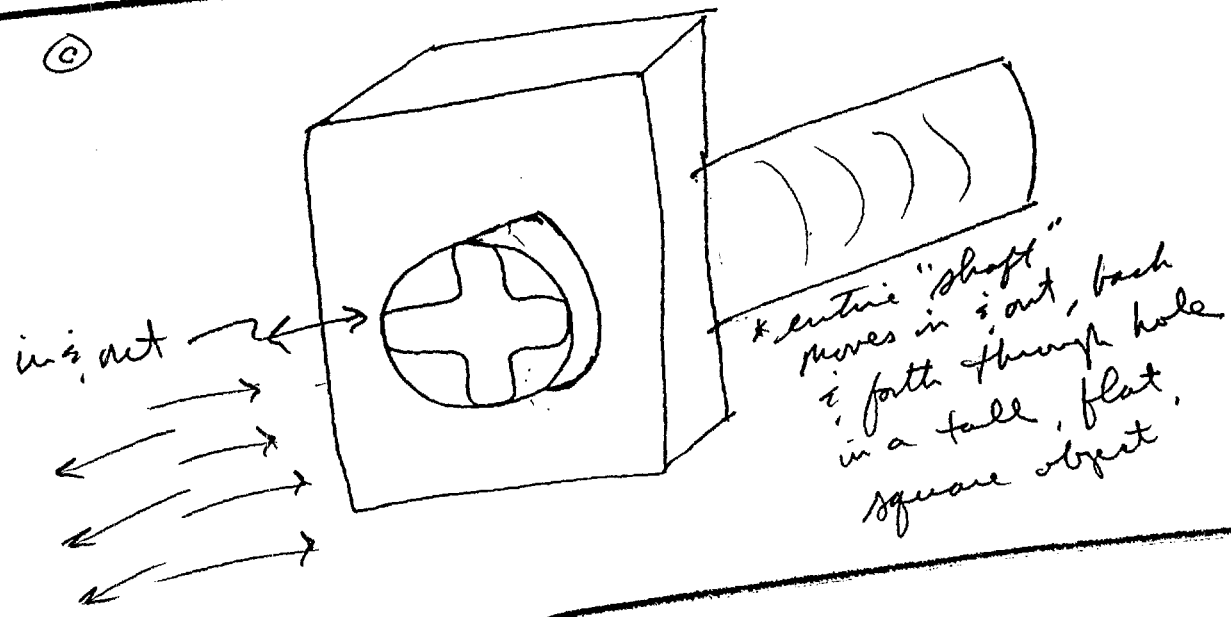

in, out

\* entire "shaft" moves in, out, back & forth through hole in a tall, flat, square object

(d)

\* series of convoluted features; some sort of material passes or moves through or around them.  
Concept of filtration.

